

THIS DRAWING IS UNPUBLISHED. RELEASED FOR PUBLICATION. ALL RIGHTS RESERVED.

© COPYRIGHT

REVISIONS

P	LTR	DESCRIPTION	DATE	DWN	APVD
B		REVISED (ECR-06-030161)	28/MAY/07	DH	JK
B1		REVISED (ECR-18-014392)	11/SEP/18	YH	YJ

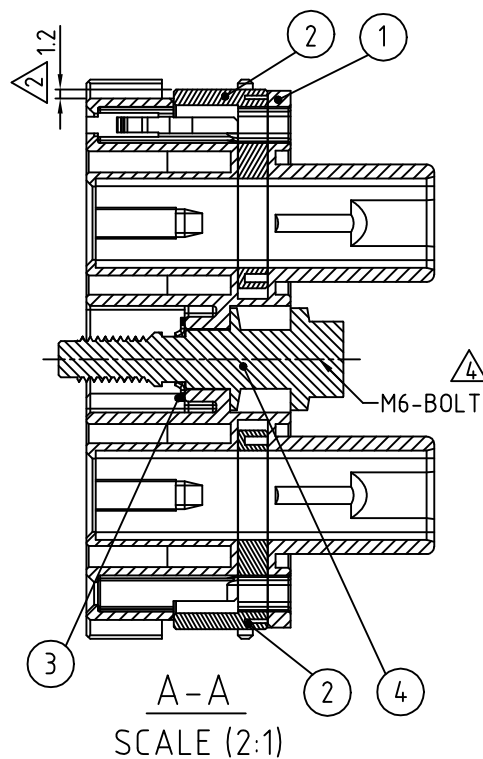
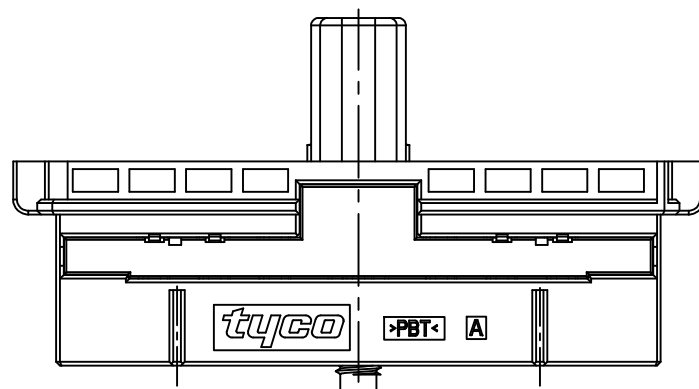

60P HYBRIDE PLUG KEY CODE.

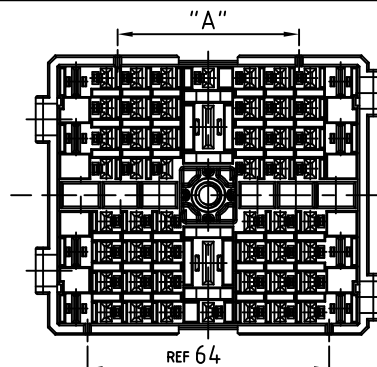

P/N	"A"	COLOR	MATERIAL
0-1743134-2	56	BLACK	PBT
1,2-1743134-3	48	GRAY	PBT

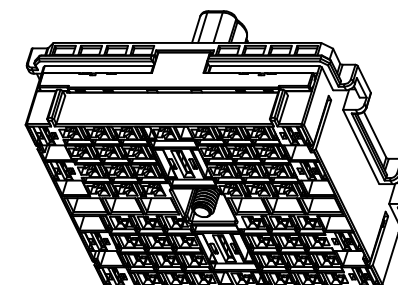

SCALE 1:2

NOTE:
 1. GENERAL TOLERANCE IS ±0.3, ±3°
 2. CONDITION OF DELIVERY : DBL PLATE PRE-ASSEMBLED POSITION
 3. APPLIED RECEPTACLE CONTACT P/N:

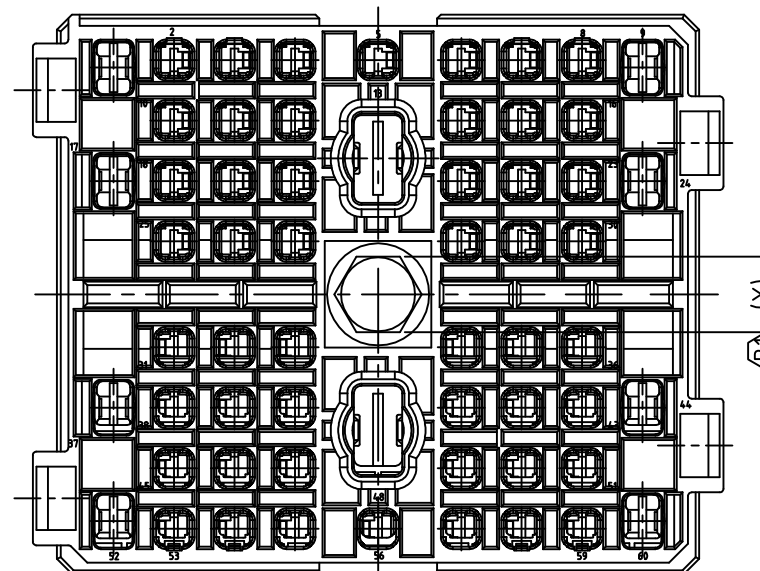
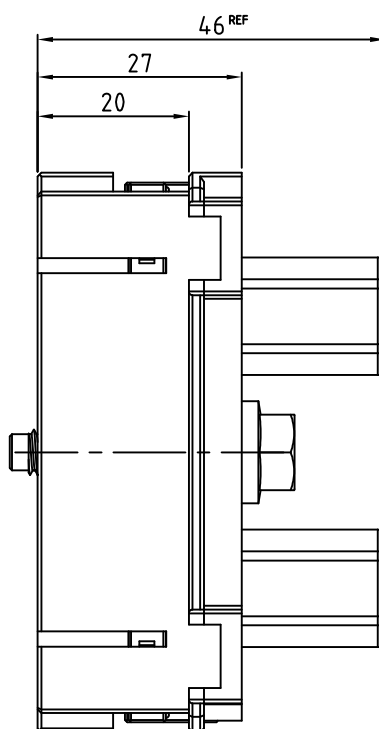
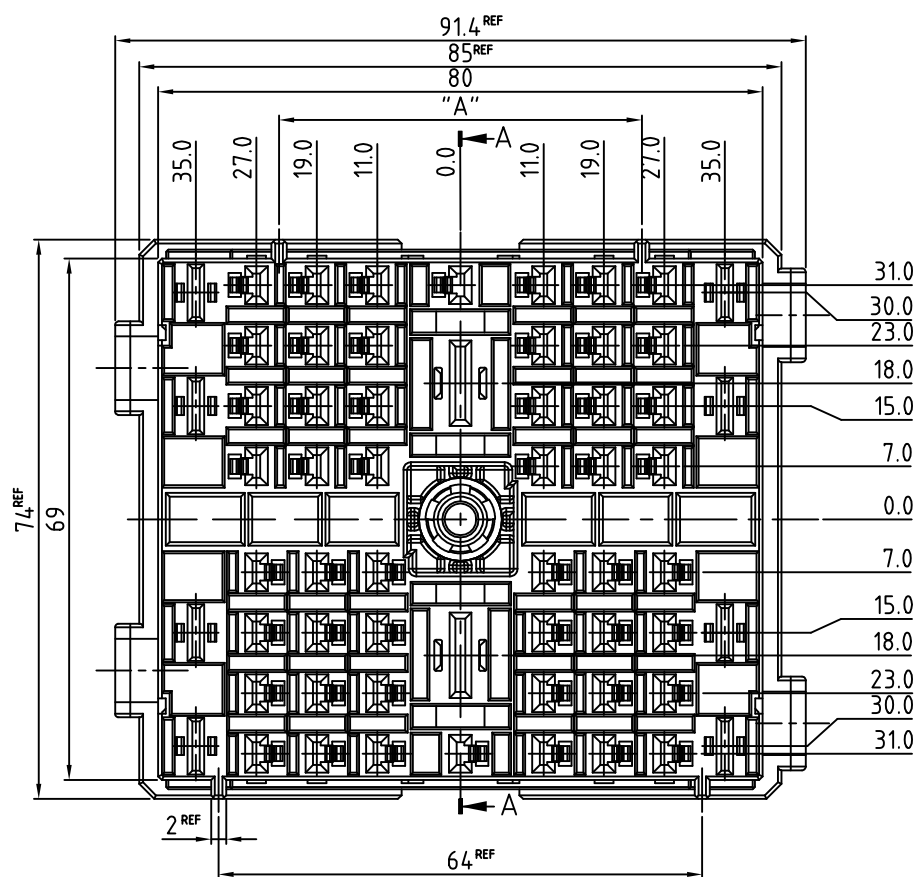

	PART No.	WIRE SIZE(mm)
MCP-E	0-1743162-1	0.3_0.85mm ²
	0-1743163-1	1.25_2.0mm ²
MCP 6.3	0-1241400-1	0.2_0.5mm ²
	0-1241402-1	0.5_1.0mm ²
	0-1241404-1	1.0_2.5mm ²
	0-1241406-1	2.5_4.0mm ²
MCP 9.5	0-1241408-1	4.0_6.0mm ²
	1-967588-1	6.0_10.0mm ²
	1-967589-1	10.0_16.0mm ²

Torque spec 0.8-1.0 Kgf.m

				ASSY P/N	2-1743134-3	1-1743134-3	0-1743134-2
4	M6 BOLT(8mm)	8	-	SWCH10A	1	•	•
	M6 BOLT(10mm)	10	-	SWCH10A	•	1	1
3	PUSH NUT(NEW)	-	-	SUS 304(3/4H)	1	1	1
2	DBL	-	NATURAL	PBT	2	2	2
1	PLUG	-	GRAY	PBT	1	1	•
		-	BLACK	PBT	•	•	1
	NAME	"X"	COLOR	MATERIAL	Q'TY		

THIS DRAWING IS A CONTROLLED DOCUMENT.

DIMENSIONS:	TOLERANCES UNLESS OTHERWISE SPECIFIED:
mm	
3rd ANGLE PROJECTION	0 PLC ± 1 PLC ± 2 PLC ± 3 PLC ± 4 PLC ± ANGLES ±
MATERIAL	FINISH
SEE TABLE	

DWN	YH MA
CHK	YH MA
APVD	YJ YOUN
PRODUCT SPEC	-
APPLICATION SPEC	-
WEIGHT	-
CUSTOMER DRAWING	

TE TE Connectivity
 HYBRID 60P PLUG ASS'Y
 (BOLT TYPE)

SIZE	CAGE CODE	DRAWING NO	RESTRICTED TO
A3	00779	1743134	-
SCALE	1/1	SHEET	1 OF 1
REV	B1		

单击下面可查看定价，库存，交付和生命周期等信息

[>>TE Connectivity\(泰科\)](#)