

LOC		DIST		REVISIONS			
GP	00	P	LTH	DESCRIPTION	DATE	DWN	APVD
		E8		RELEASE 2-3	10AUG2014	CZ	SZ
		E9		ADD NEW DASH NUMBER 3-0	19AUG2014	CZ	SZ

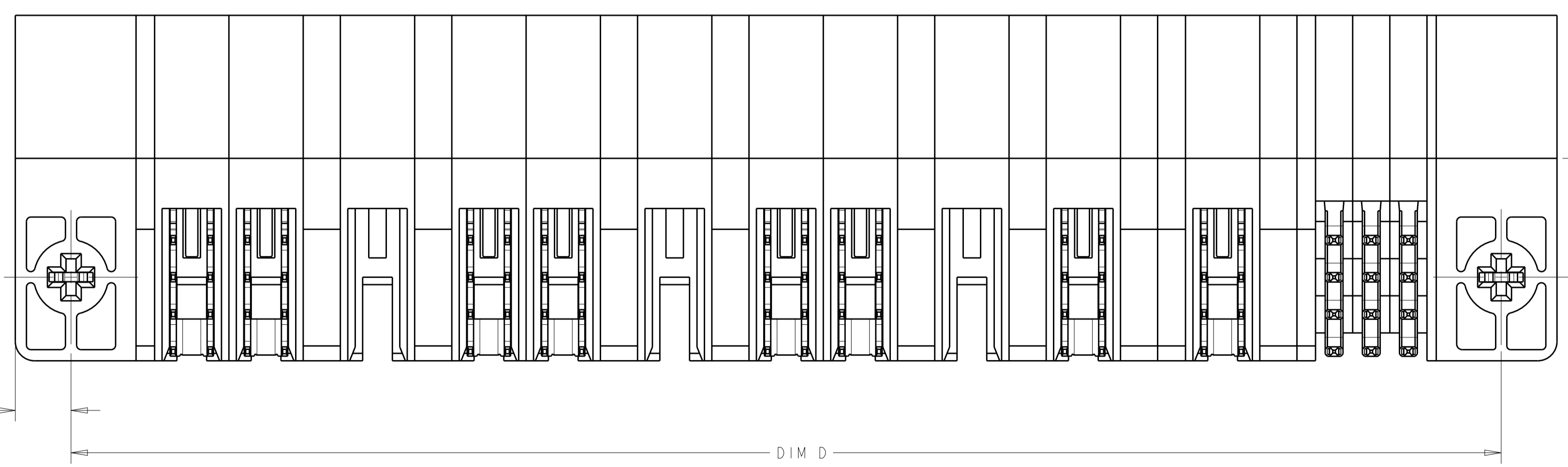

- 1 "AMP" TRADEMARK, PART NUMBER, AND DATE CODE TO BE MARKED IN AREA SHOWN
- 2 MATERIAL:  
HOUSING - GLASS FILLED HIGH TEMP THERMO PLASTIC, UL94 V-0  
SIGNAL CONTACT - COPPER ALLOY  
POWER CONTACT - HIGH CONDUCTIVITY COPPER ALLOY
- 3 CONTACT PLATING: NOBLE METAL PLATING ON CONTACT FUNCTIONAL AREA OF POWER AND SIGNAL CONTACTS.
- 4 MECHANICAL CONNECTOR KEEP OUT ZONE.
- 5 DATUM AND BASIC DIMENSIONS ESTABLISHED BY CUSTOMER.
- 6 PCB - ALL HOLES DIAMETERS ARE FINISHED HOLE SIZES.
- 7 PCB - .0453±.0010 DRILLED HOLES PLATED WITH .0003 MIN. Sn OVER .001 TO .003 CU PLATING TO ACHIEVE A .040±.003 DIA HOLE.
- 8 NOT RELEASED FOR PRODUCTION
- 9 VARIABLE DIMENSIONS SHOWN ON VIEW (SHEET 2)

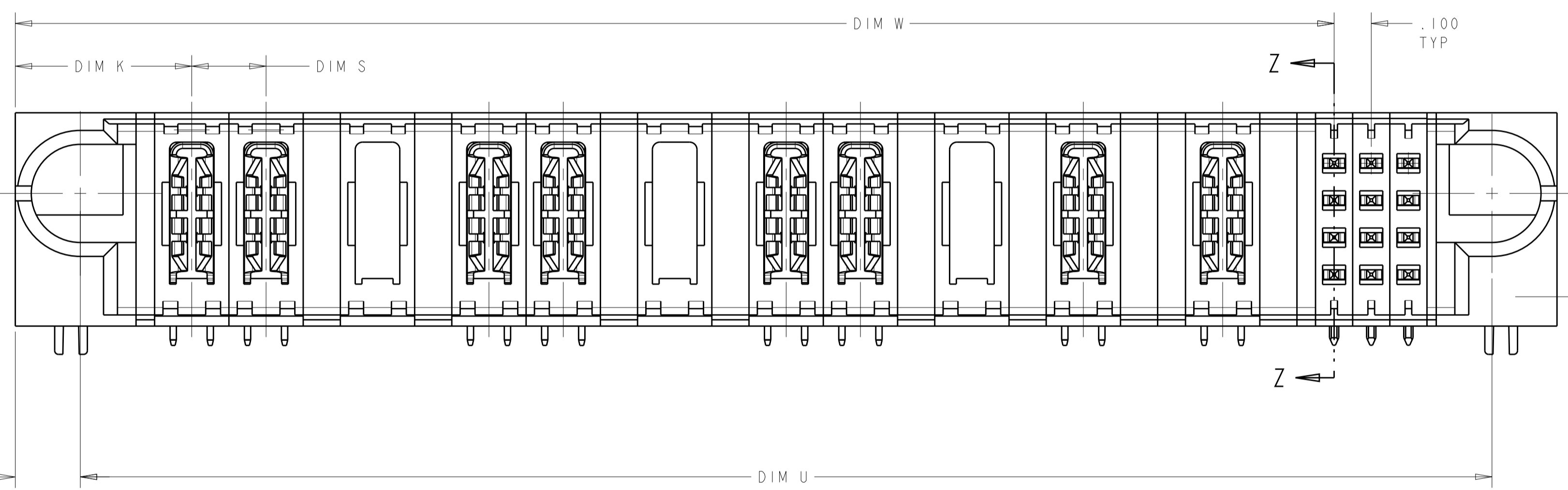
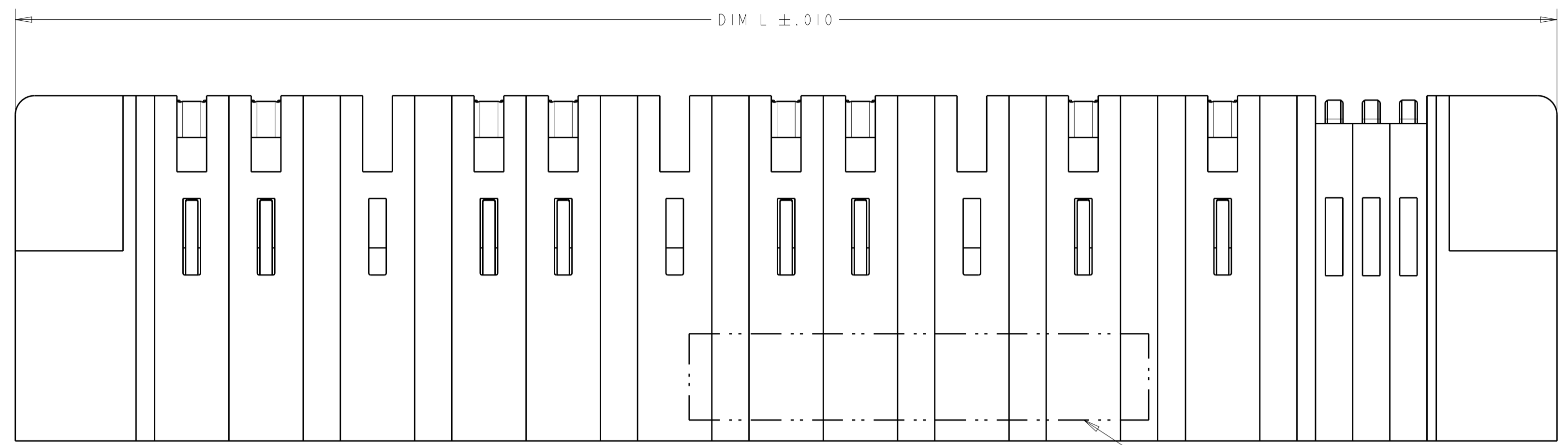
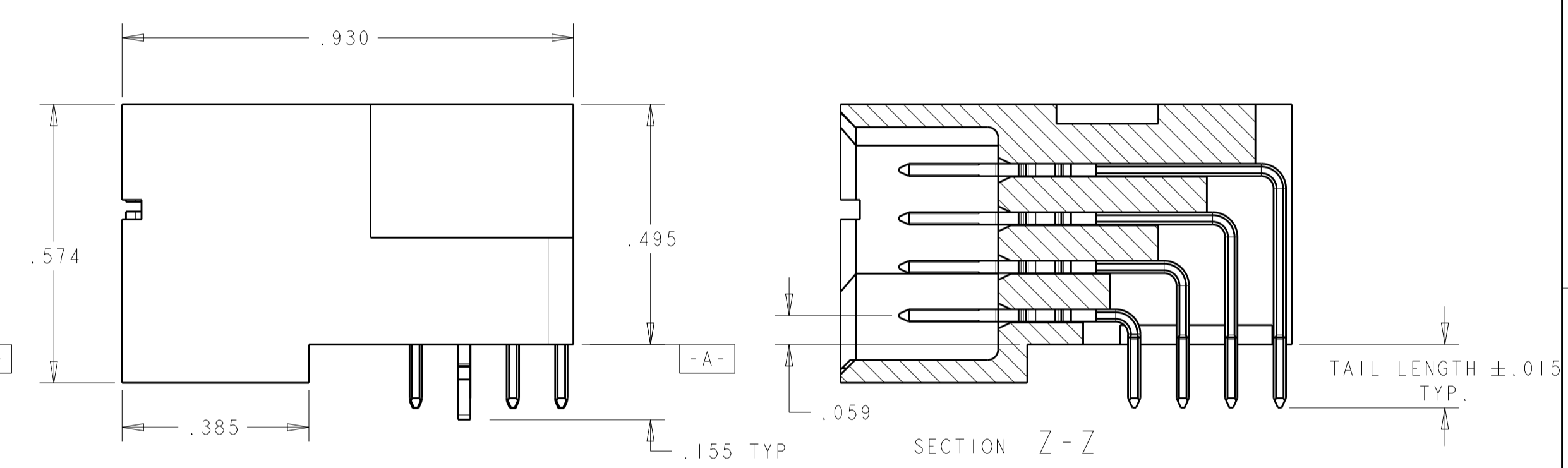

THIS DRAWING IS A CONTROLLED DOCUMENT. DWN: R. GRZYBOWSKI 02FEB05  
 CHK: M. PERCHERKE 02FEB05

**STE** TE Connectivity

NAME: RIGHT ANGLE HEADER ASSY W/GUIDES MULTI-BEAM XL

PRODUCT SPEC: 108-1973  
 APPLICATION SPEC: 114-13038

SIZE: A100779 C=6450122  
 CAGE CODE: 6450122

MATERIAL: 2 FINISH: 3

CUSTOMER DRAWING SCALE: 4:1 SHEET 1 OF 10 REV: E9

THIS DRAWING IS UNPUBLISHED. RELEASED FOR PUBLICATION 20  
 © COPYRIGHT 20 BY - ALL RIGHTS RESERVED.

LOC		DIST		REVISIONS			
P	LYN	DESCRIPTION	DATE	OWN	APVD		
-	-	SEE SHEET 1	-	-	-		

E9	1.700	.250	1.375	1.750	.450	2.050	4P + 16S	3-6450122-0
	2.400	.250	1.875	2.450	.450	2.750	6P + 24S	2-6450122-9
	1.300	.250	1.175	1.350	.450	1.650	3P + 8S	2-6450122-8
	2.050	.250	1.925	2.100	.450	2.400	6P + 8S	2-6450122-7
	4.425	.200	2.200	4.475	.450	4.775	9P + 92S	2-6450122-6
	2.900	.250	2.375	2.950	.450	3.250	8P + 24S	2-6450122-5
	2.700	.250	.875	2.750	.450	3.050	2P + 76S	2-6450122-4
	2.300	.250	1.875	2.350	.450	2.650	6P + 20S	2-6450122-3
	3.200	.250	2.875	3.250	.450	3.550	10P + 16S	2-6450122-2
	1.650	.200	1.225	1.700	.450	2.000	4P + 20S	2-6450122-1
	2.950	.200	2.425	3.000	.450	3.300	10P + 24S	2-6450122-0
	1.800	.250	1.375	1.850	.450	2.150	4P + 20S	1-6450122-9
	2.250	.250	1.975	2.300	.475	2.600	6P + 12S	1-6450122-7
	1.000	.250	.875	1.050	.450	1.350	2P + 8S	1-6450122-6
	1.850	.300	1.325	1.900	.475	2.200	3ACP + 24S	1-6450122-2
	5.900	.250	5.375	5.950	.450	6.250	20P + 24S	1-6450122-1
	1.400	.250	.875	1.450	.450	1.750	2P + 24S	1-6450122-0
	3.050	.250	2.125	3.100	.450	3.400	7P + 40S	6450122-8
	4.425	.250	3.875	4.475	.450	4.775	14P + 24S	6450122-6
	3.800	.250	3.550	3.850	.475	4.150	11P + 12S	6450122-3
	4.600	.250	3.875	4.650	.450	4.950	14P + 32S	6450122-2
	3.800	.250	3.550	3.850	.475	4.150	11P + 12S	6450122-1
	DIM U	DIM S	DIM W	DIM D	DIM K	DIM L	DESCRIPTION	PART NUMBER

THIS DRAWING IS A CONTROLLED DOCUMENT.		OWN R. GRZYBOWSKI	02FEB05		TE Connectivity
DIMENSIONS: INCHES		CHK M. PERCHERKE	02FEB05		
TOLERANCES UNLESS OTHERWISE SPECIFIED:		APVD M. PERCHERKE	NAME	RIGHT ANGLE HEADER ASSY W/GUIDES MULTI-BEAM XL	
0 PLC ±.01		PRODUCT SPEC	SIZE	CAGE CODE	DRAWING NO
1 PLC ±.01		APPLICATION SPEC	A100779	6450122	RESTRICTED TO
3 PLC ±.005		FINISH	SCALE	SHEET	OF
4 PLC ±.0020			4:1	2	10
ANGLES ±.020		WEIGHT	REV E9		
MATERIAL		CUSTOMER DRAWING			

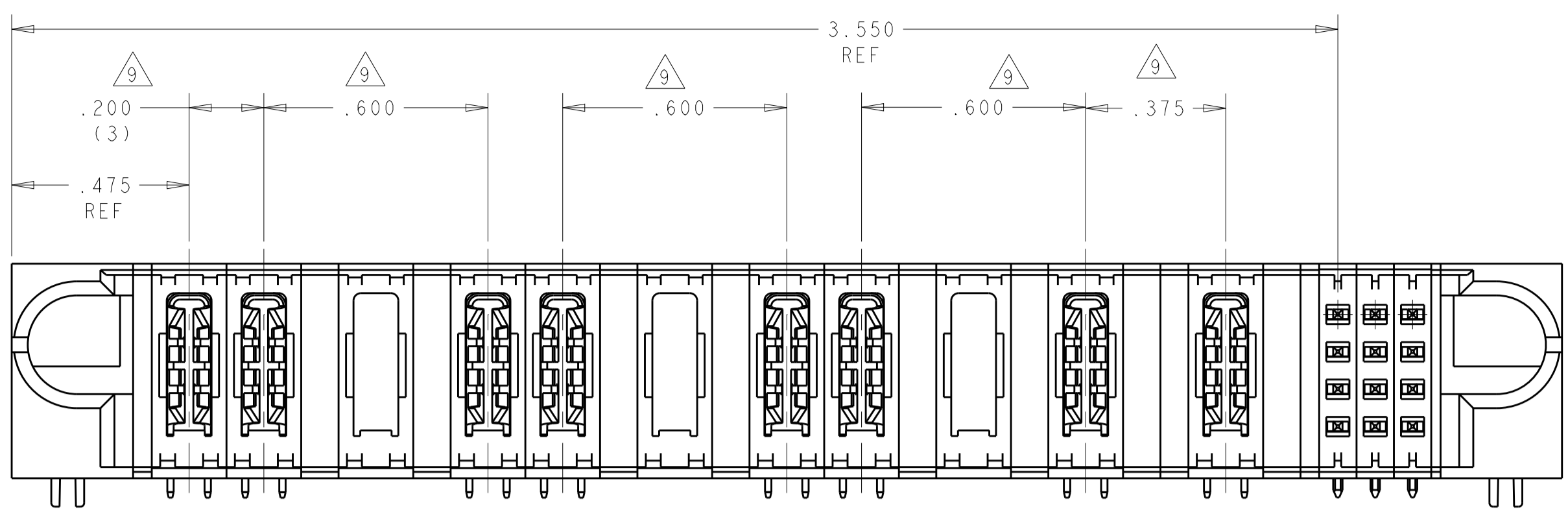

SCALE 3:1

PART NUMBER	ROWS	POWER										SIGNAL												
		P1	P2	P3	P4	P5	P6	P7	P8	P9	P10	P11	1	2	3									
6450122-1	D C B A	PM	PM		PM	PM		PM	PM		PM	PM	J	J	J	K	K	K	N	N	N	S	S	S
11P + 12S		NO CONTACT LOADED																						

PART NUMBER	ROWS	POWER										SIGNAL												
		P1	P2	P3	P4	P5	P6	P7	P8	P9	P10	P11	1	2	3									
6450122-3	D C B A	PM			PM			PM			PM	PM	J	J	J	K	K	K	N	N	N	S	S	S
11P + 12S		NO CONTACT LOADED																						

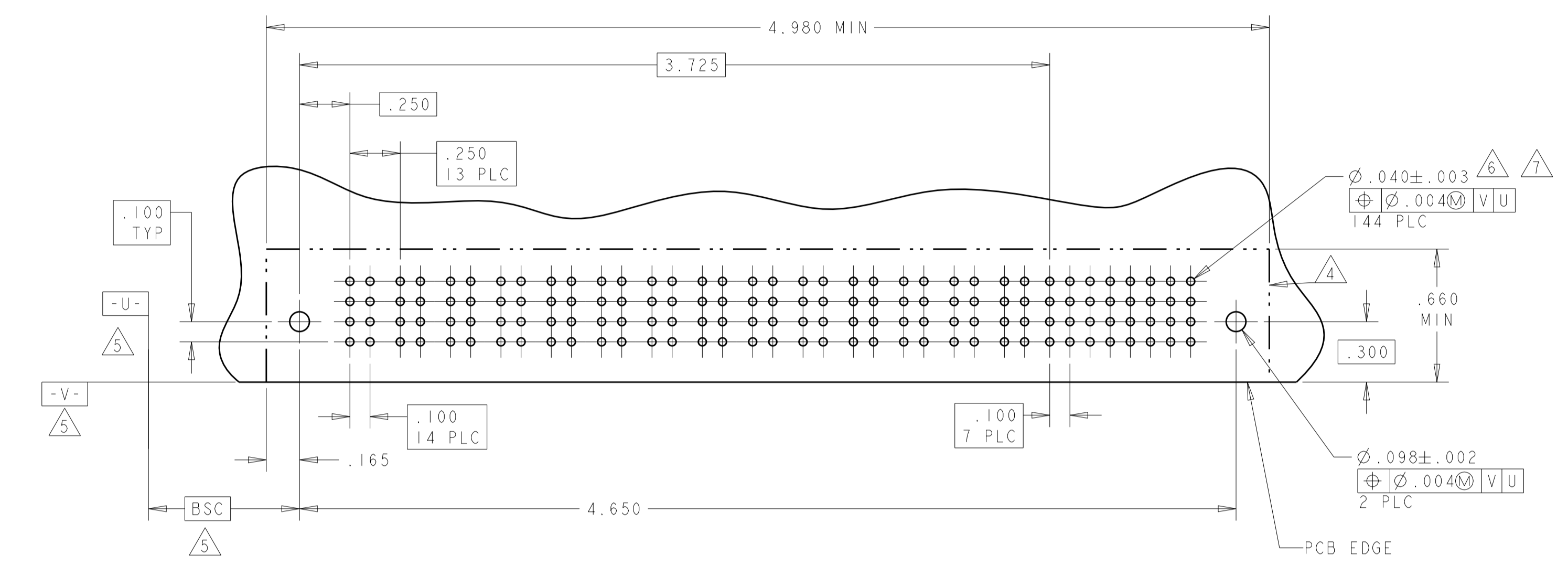
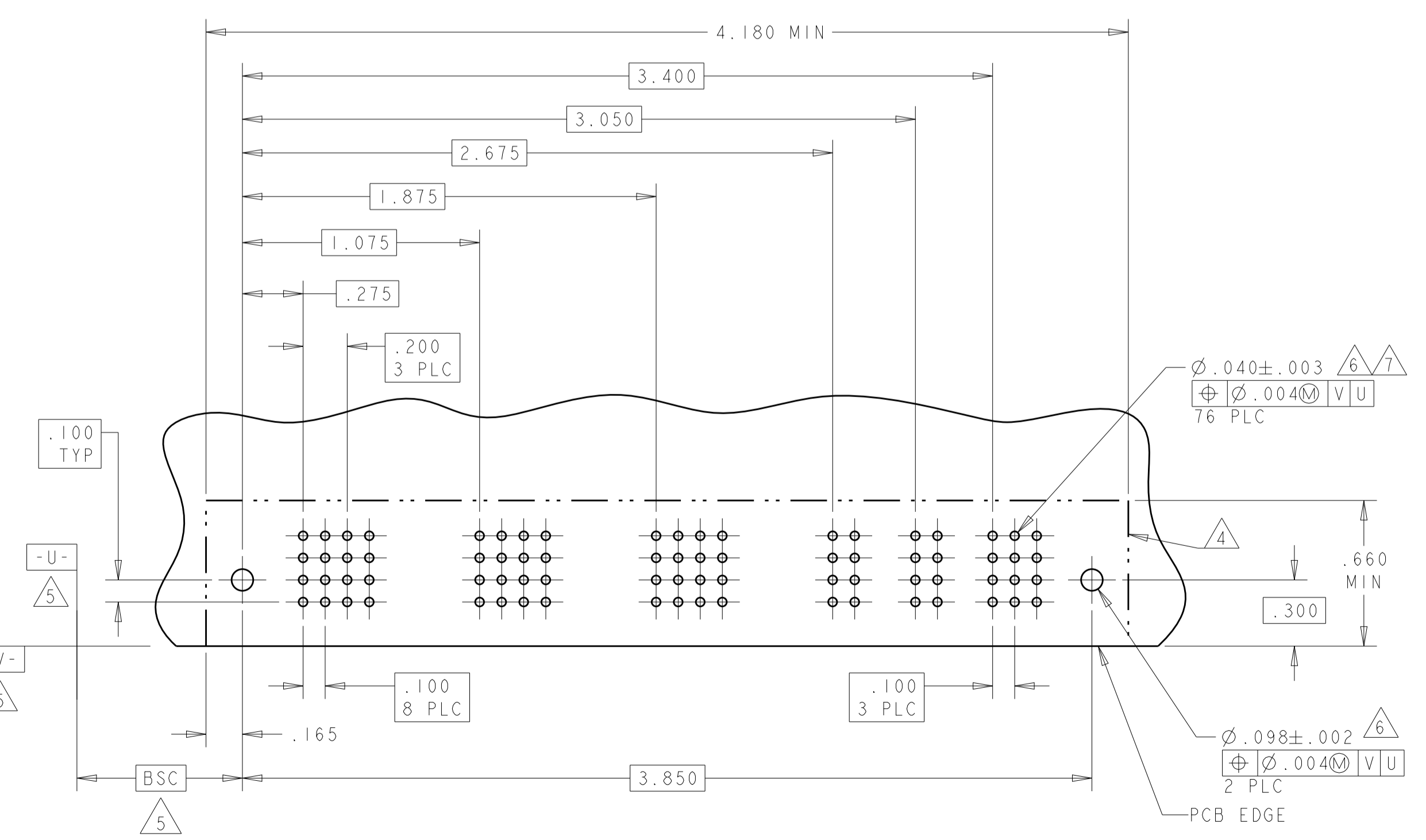

PART NUMBER	ROWS	POWER														SIGNAL																						
		P1	P2	P3	P4	P5	P6	P7	P8	P9	P10	P11	P12	P13	P14	1	2	3	4	5	6																	
6450122-6	D C B A	PM	PM	PM	PM	PM	PM	PM	PM	PM	PM	PM	PM	PM	J	J	J	J	J	J	K	K	K	K	K	K	N	N	N	N	N	N	S	S	S	S	S	S
14P + 24S																																						

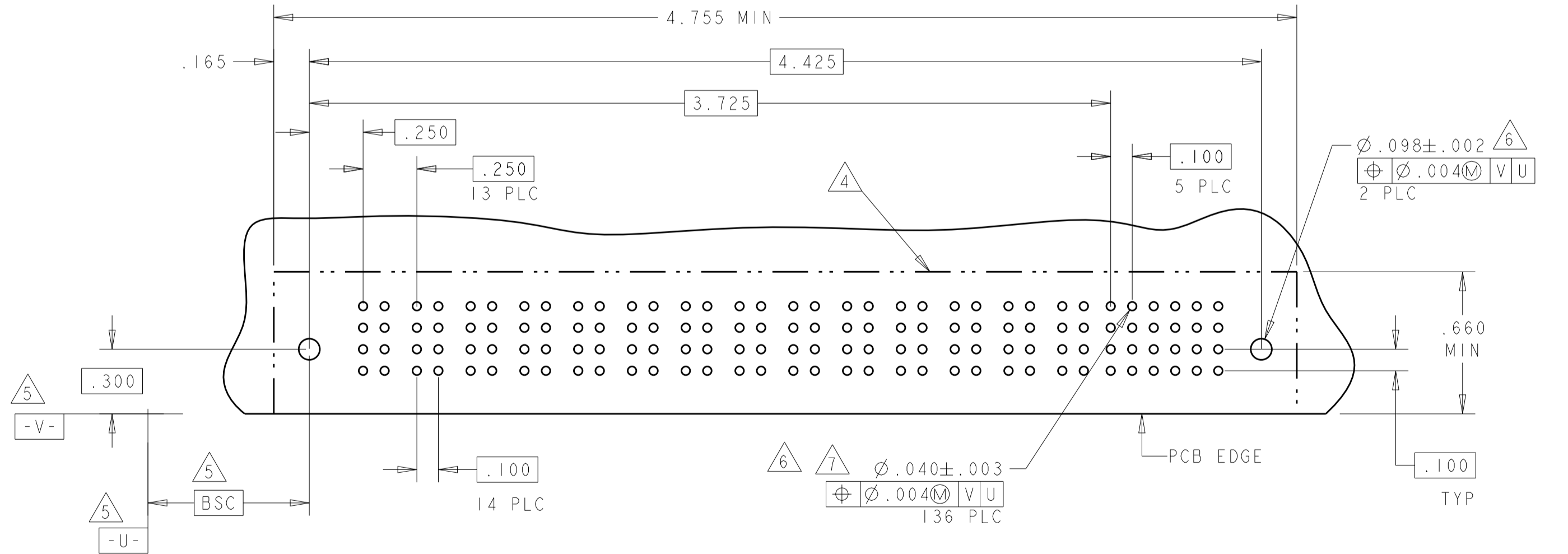

Z	STD	.090	D
Y	STD	.090	C
R	STD	.090	B
O	STD	.090	A
H	MLBF	.135	A
J	STD	.135	D
K	STD	.135	C
N	STD	.135	B
S	STD	.135	A
CODE	MATING SEQUENCE	TAIL LENGTH	ROW
SIGNAL CONTACT			

THIS DRAWING IS A CONTROLLED DOCUMENT.

OWN: R. GRZYBOWSKI 02FEB05  
 CHK: M. PERCHERKE 02FEB05  
 APVD: M. PERCHERKE

PRODUCT SPEC: 108-1973  
 APPLICATION SPEC: 114-13038  
 WEIGHT: A100779  
 CUSTOMER DRAWING: C=6450122

PA: .090  
 PM: .135  
 CODE: TAIL LENGTH  
 POWER CONTACT

**STE** TE Connectivity

RIGHT ANGLE HEADER ASSY W/GUIDES MULTI-BEAM XL

SCALE: 4:1 SHEET 3 OF 10 REV: E9

LOC	DIST	REV	DATE	OWN	APVD
GP	00				

REV	DATE	OWN	APVD
1			

PART NUMBER	ROWS	POWER							SIGNAL									
		P1	P2	P3	P4	P5	P6	P7	1	2	3	4	5	6	7	8	9	10
6450122-8	D C B A	PM	PM	PM	PM	PM	PM	PM	J	J	J	J	J	J	J	J	J	J
									K	K	K	K	K	K	K	K	K	K
									N	N	N	N	N	N	N	N	N	N
									S	S	S	S	S	S	S	S	S	S
7P + 40S																		

PART NUMBER	ROWS	POWER		SIGNAL					
		P1	P2	1	2	3	4	5	6
1-6450122-0	D C B A	PM	PM	J	J	J	J	J	J
				K	K	K	K	K	K
				N	N	N	N	N	N
				S	S	S	S	S	S
2P + 24S									

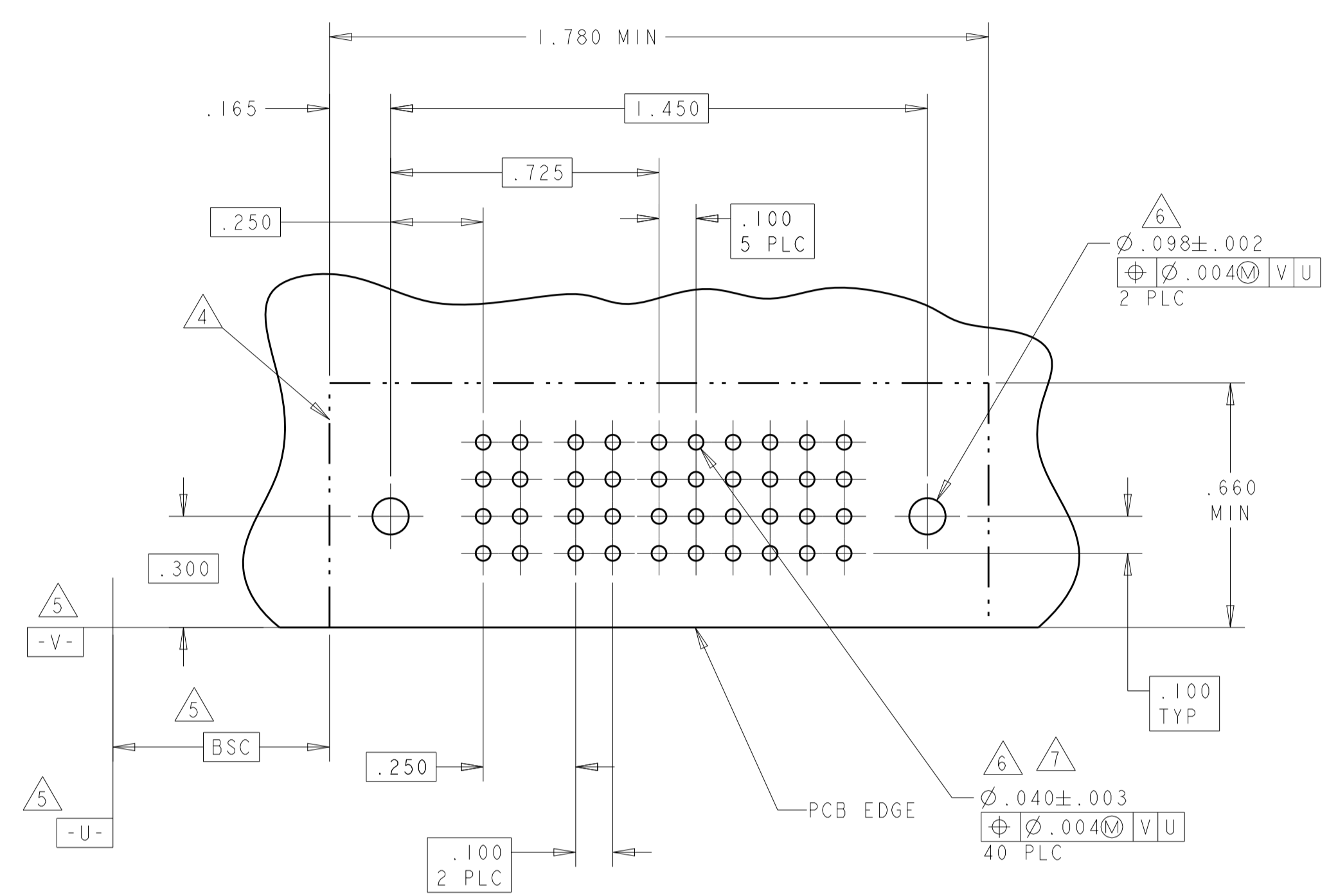
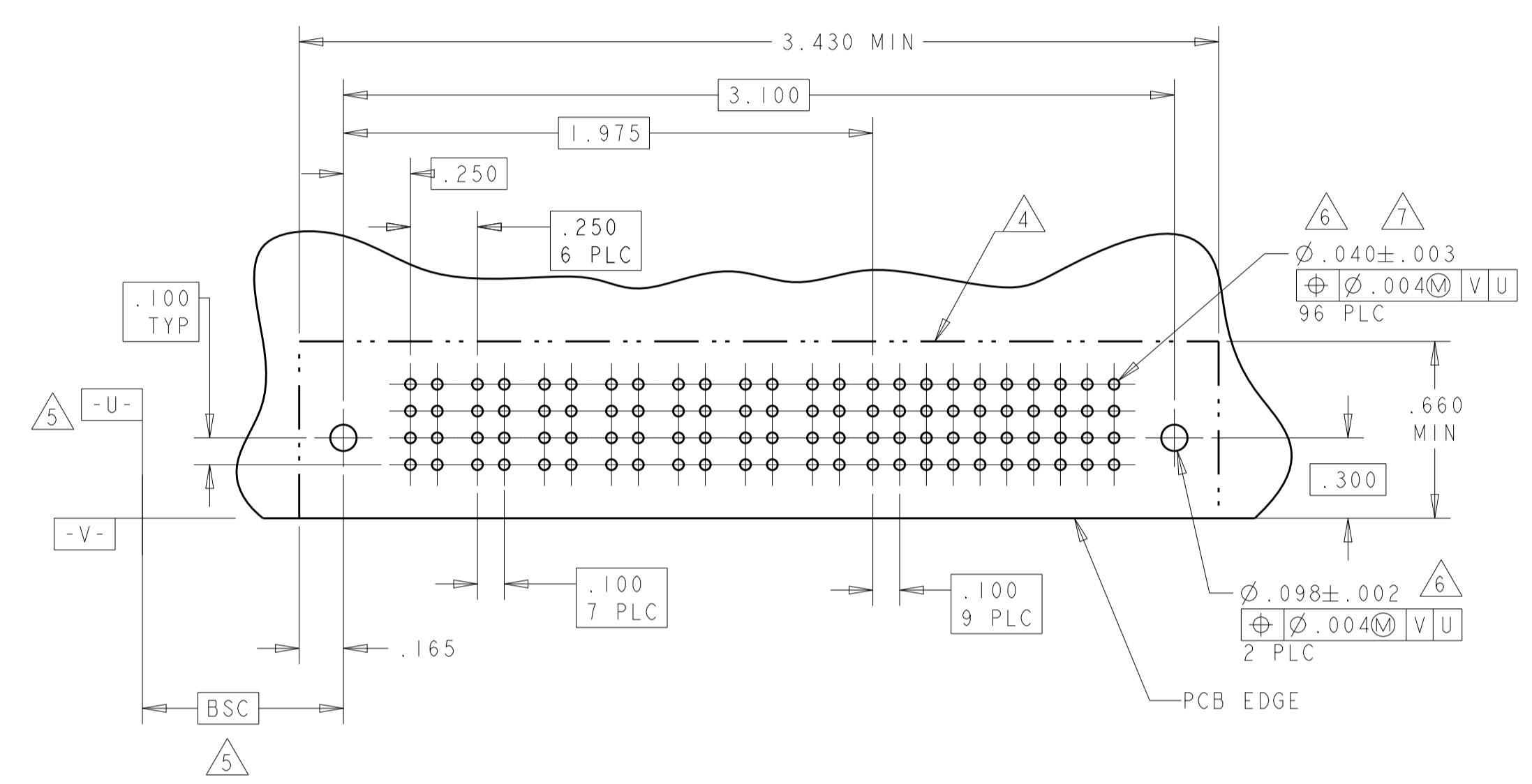

PART NUMBER	ROWS	POWER																				SIGNAL					
		P1	P2	P3	P4	P5	P6	P7	P8	P9	P10	P11	P12	P13	P14	P15	P16	P17	P18	P19	P20	1	2	3	4	5	6
1-6450122-1	D C B A	PM	PM	PM	PM	PM	PM	PM	PM	PM	PM	PM	PM	PM	PM	PM	PM	PM	PM	PM	PM	J	J	J	J	J	J
																						K	K	K	K	K	K
																						N	N	N	N	N	N
																						S	S	S	S	S	S
20P + 24S																											

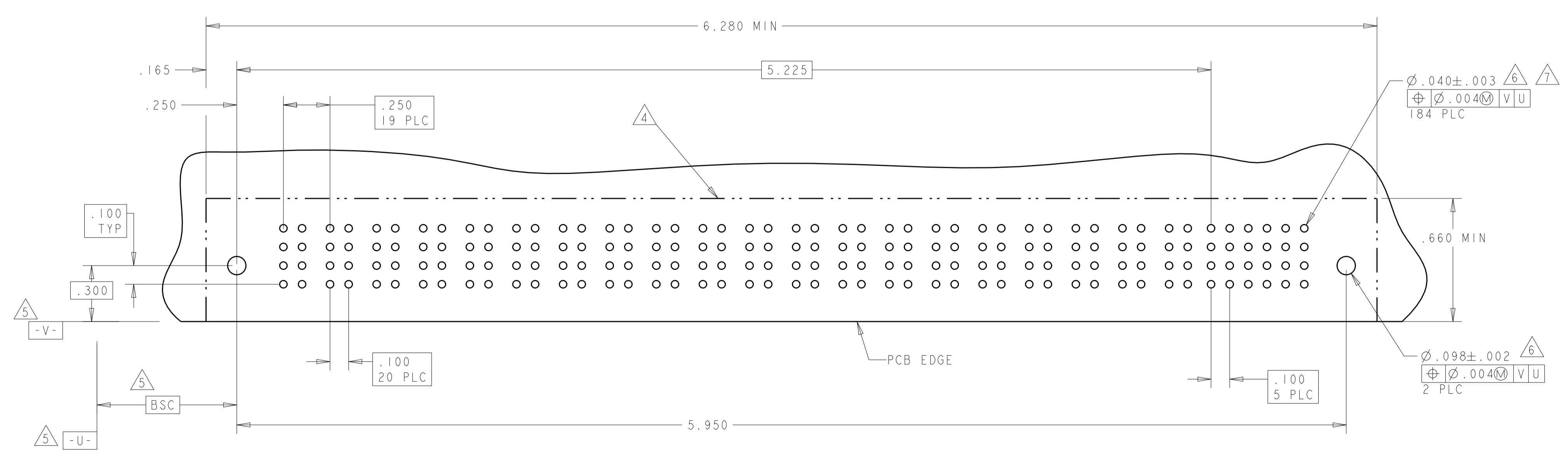

THIS DRAWING IS A CONTROLLED DOCUMENT.

DIMENSIONS: INCHES	TOLERANCES UNLESS OTHERWISE SPECIFIED:	DWN: R. GRZYBOWSKI 02FEB05	CHK: M. PERCHERKE 02FEB05	APVD: M. PERCHERKE	NAME: RIGHT ANGLE HEADER ASSY W/GUIDES MULTI-BEAM XL
0 PLC ± .01	1 PLC ± .01	PRODUCT SPEC: 108-1973	APPLICATION SPEC: 114-13038	WEIGHT: -	RESTRICTED TO: -
2 PLC ± .005	3 PLC ± .005	SIZE: A100779	CAGE CODE: C=6450122	SCALE: 4:1	SHEET 4 OF 10
4 PLC ± .0020	ANGLES ± .2	CUSTOMER DRAWING	REV: E9		

LOC	DIST	REVISIONS			
GP	00	REV	DATE	BY	APPROV
		1			
		SEE SHEET 1			

PART NUMBER	ROWS	POWER			SIGNAL						
		P1	P2	P3	1	2	3	4	5	6	
1-6450122-2	D	PM	PM	PM	J	J	J	J	J	J	
	C				K	K	K	K	K	K	
	B				N	N	N	N	N	N	
	A				S	S	S	S	S	S	
3ACP + 24S											

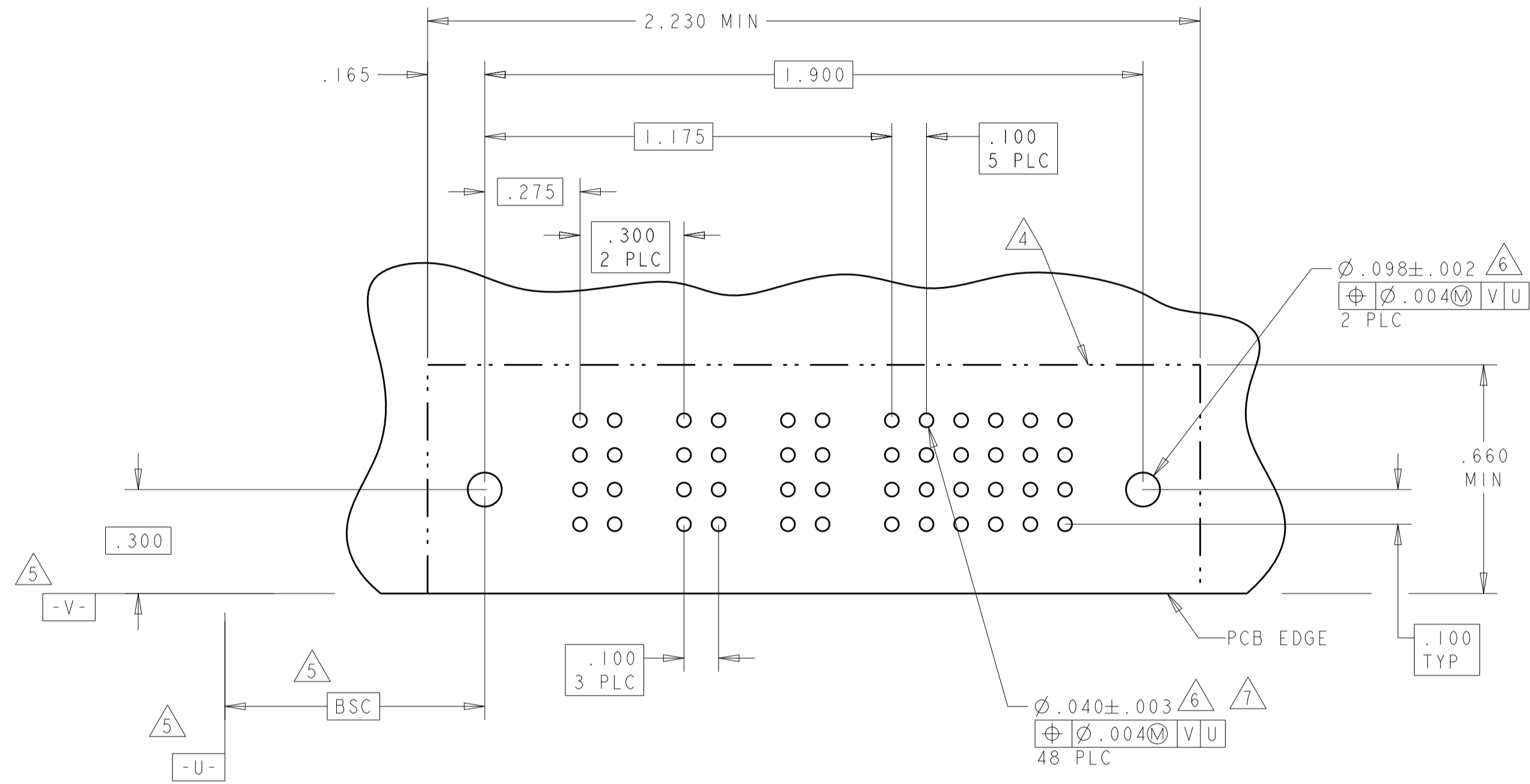

PART NUMBER	ROWS	POWER				SIGNAL					
		P1	P2	P3	P4	1	2	3	4	5	
1-6450122-9	D	PM	PM	PM	PM	J	J	J	J	J	
	C					K	K	K	K	K	
	B					N	N	N	N	N	
	A					S	S	S	S	S	
4P + 20S											

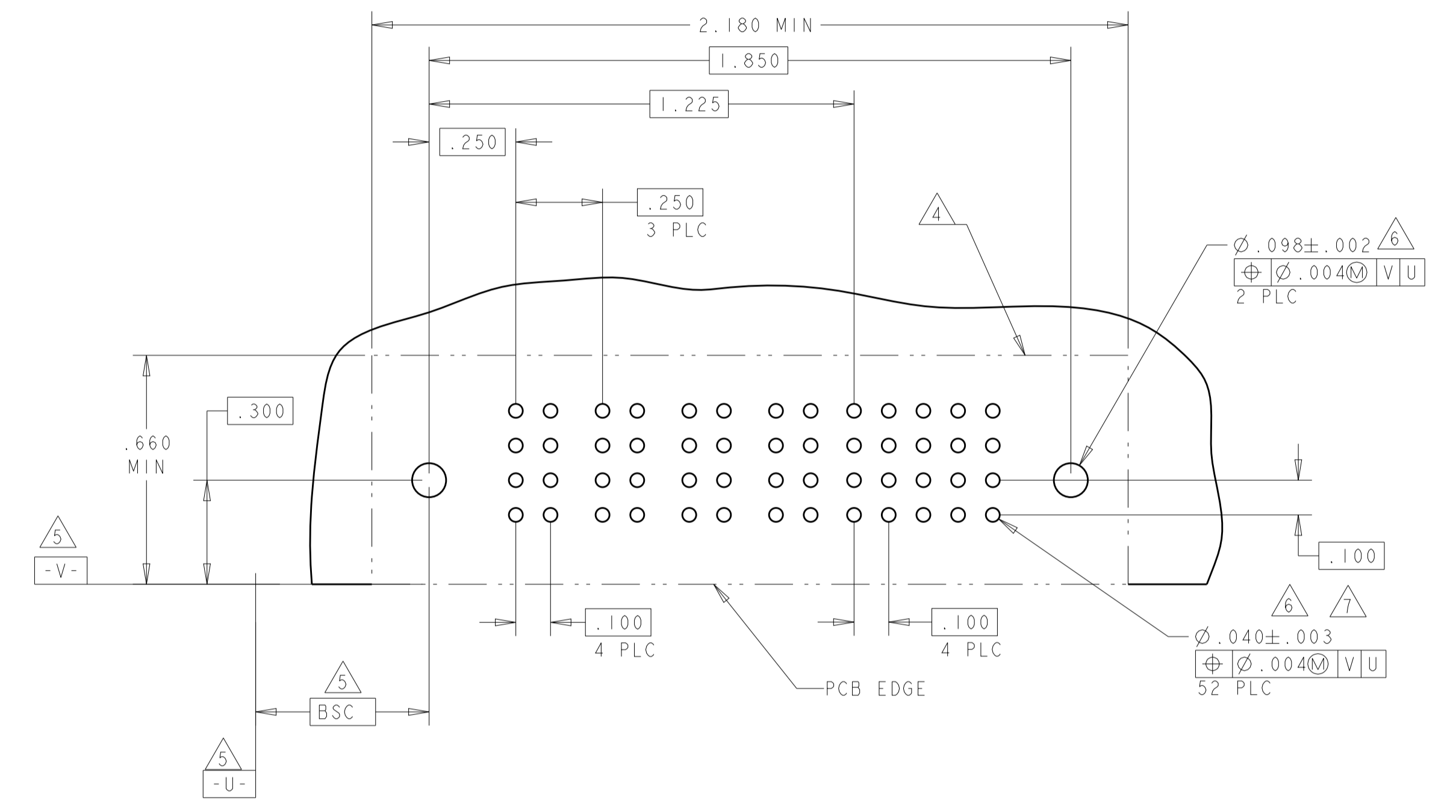

NO CONTACTS LOADED

PART NUMBER	ROWS	POWER		SIGNAL	
		P1	P2	1	2
1-6450122-6	D	PM	PM	J	J
	C			K	K
	B			N	N
	A			S	S
2P + 8S					

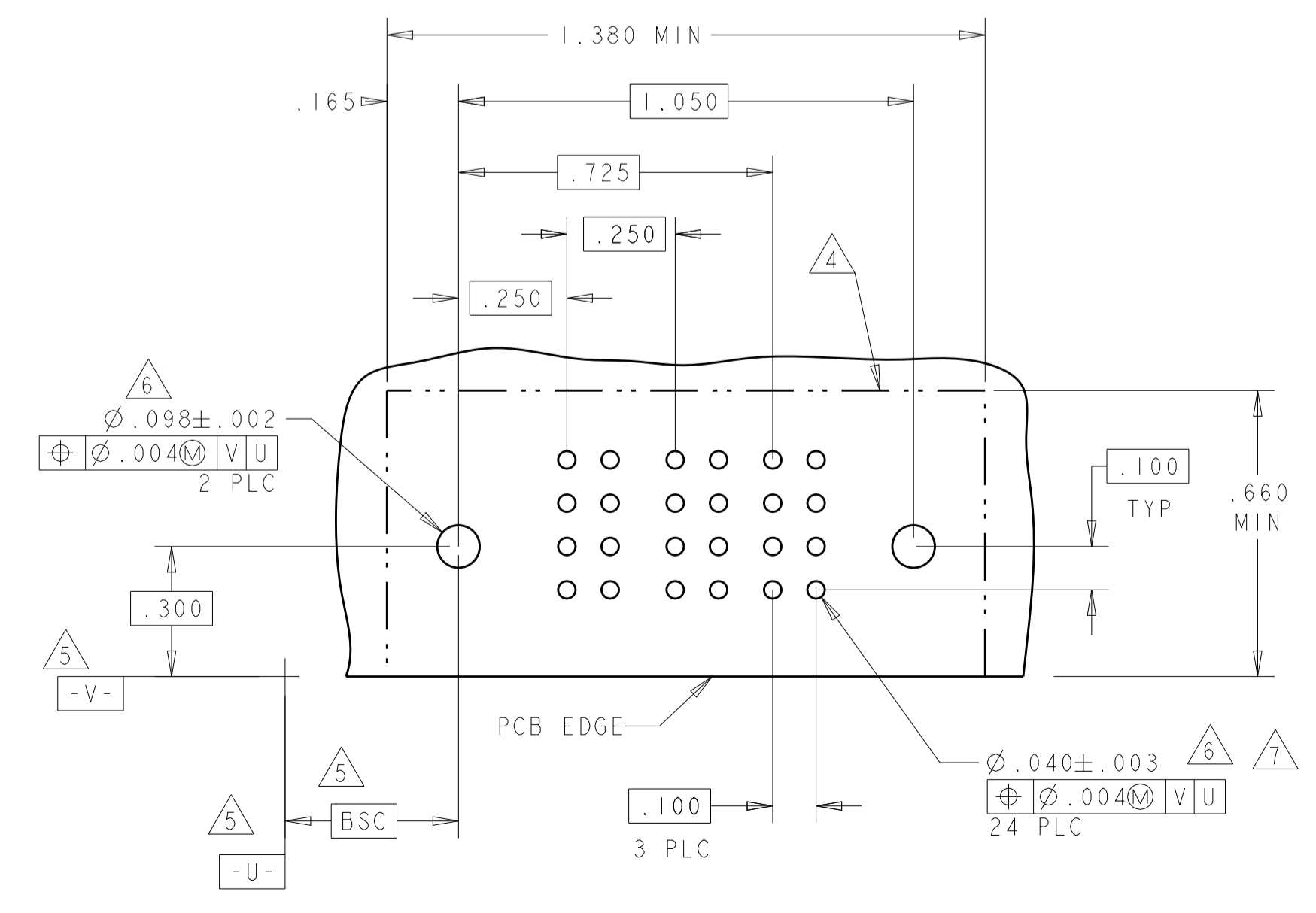

PART NUMBER	ROWS	POWER										SIGNAL															
		P1	P2	P3	P4	P5	P6	P7	P8	P9	P10	1	2	3	4	5	6										
2-6450122-0	D	PM	PM	PM	PM	PM	PM	PM	PM	PM	PM	PM	PM	PM	PM	PM	PM	PM									
	C																		J	J	J	J	J	J	J	J	J
	B																		K	K	K	K	K	K	K	K	K
	A																		N	N	N	N	N	N	N	N	N
10P + 24S																											

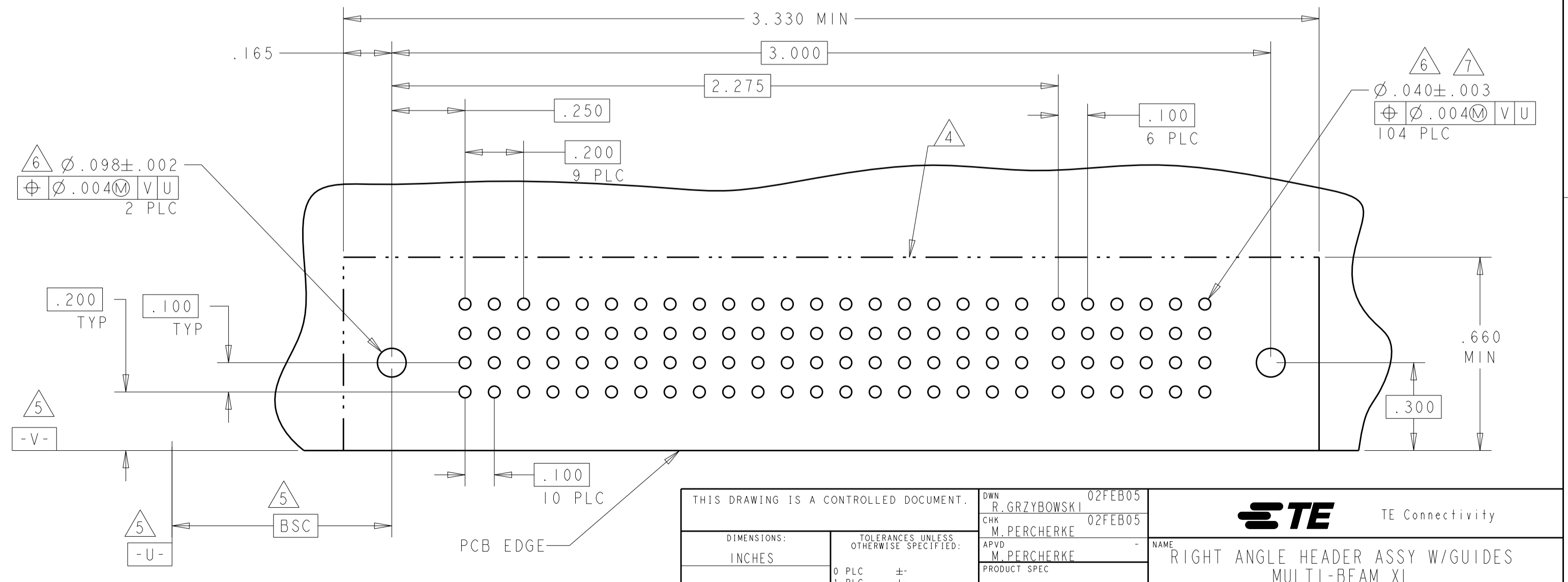

THIS DRAWING IS A CONTROLLED DOCUMENT.

DIMENSIONS: INCHES	TOLERANCES UNLESS OTHERWISE SPECIFIED:	OWN: R. GRZYBOWSKI 02FEB05	CHK: M. PERCHERKE 02FEB05	APVD: M. PERCHERKE	NAME: RIGHT ANGLE HEADER ASSY W/GUIDES MULTI-BEAM XL
MATERIAL:	FINISH:	PRODUCT SPEC: 108-1973	APPLICATION SPEC: 114-13038	WEIGHT:	SIZE: A1
		CAGE CODE: 6450122	DRAWING NO: 100779	SHEET: 5	REV: E9

SCALE: 4:1

LOC	DIST	REVISIONS			
GP	00	REV	DATE	BY	APPV
		1	SEE SHEET 1		

PART NUMBER	ROWS	POWER						SIGNAL		
		P1	P2	P3	P4	P5	P6	1	2	3
1-6450122-7	D	PM	PM	PM	PM	PM	J	J	J	
	C						K	K	K	
	B						N	N	N	
	A						S	S	S	
6P + 12S		HD								HD

PART NUMBER	ROWS	POWER				SIGNAL				
		P1	P2	P3	P4	1	2	3	4	5
2-6450122-1	D	PM	PM	PM	PM	J	J	J	J	J
	C					K	K	K	K	
	B					N	N	N	N	
	A					H	H	H	H	
4P + 20S		HD								HD

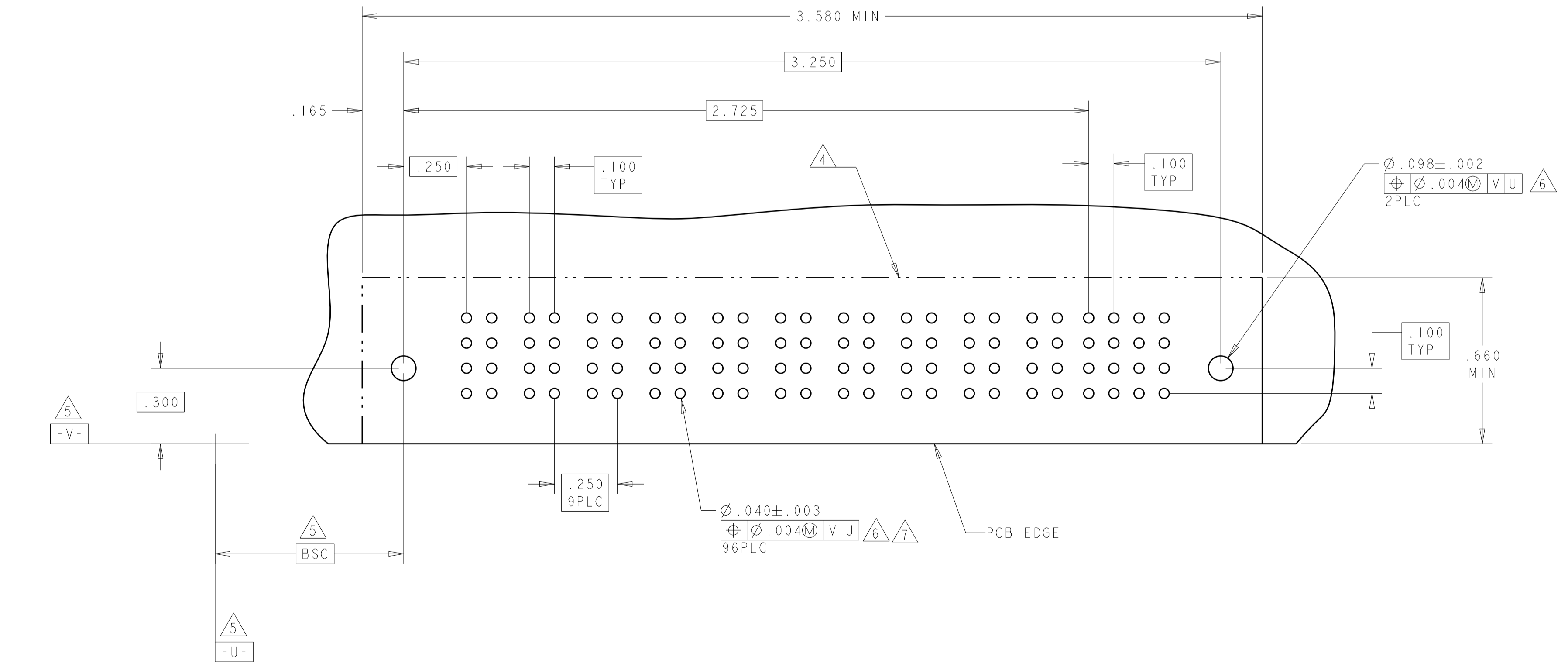
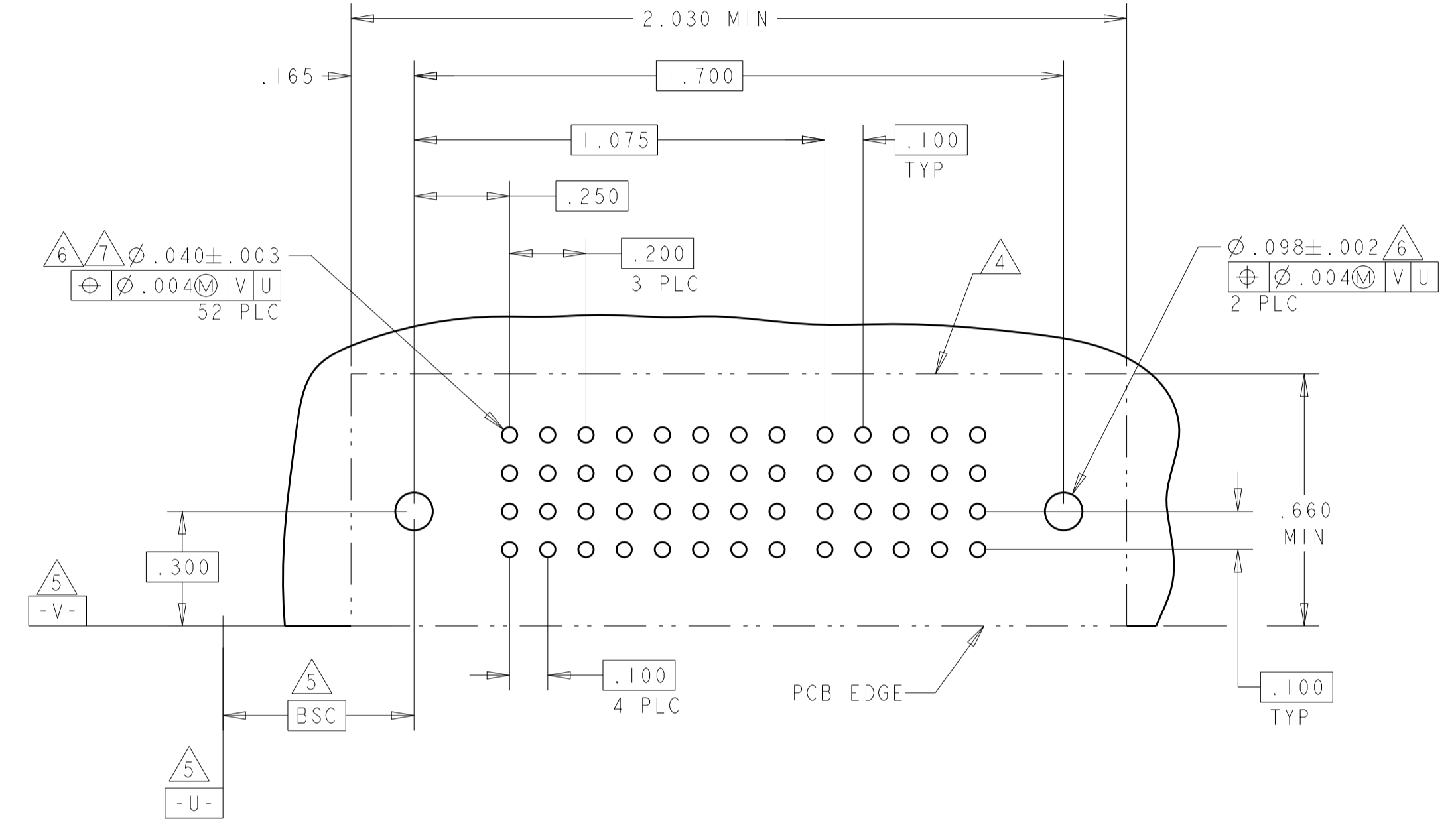
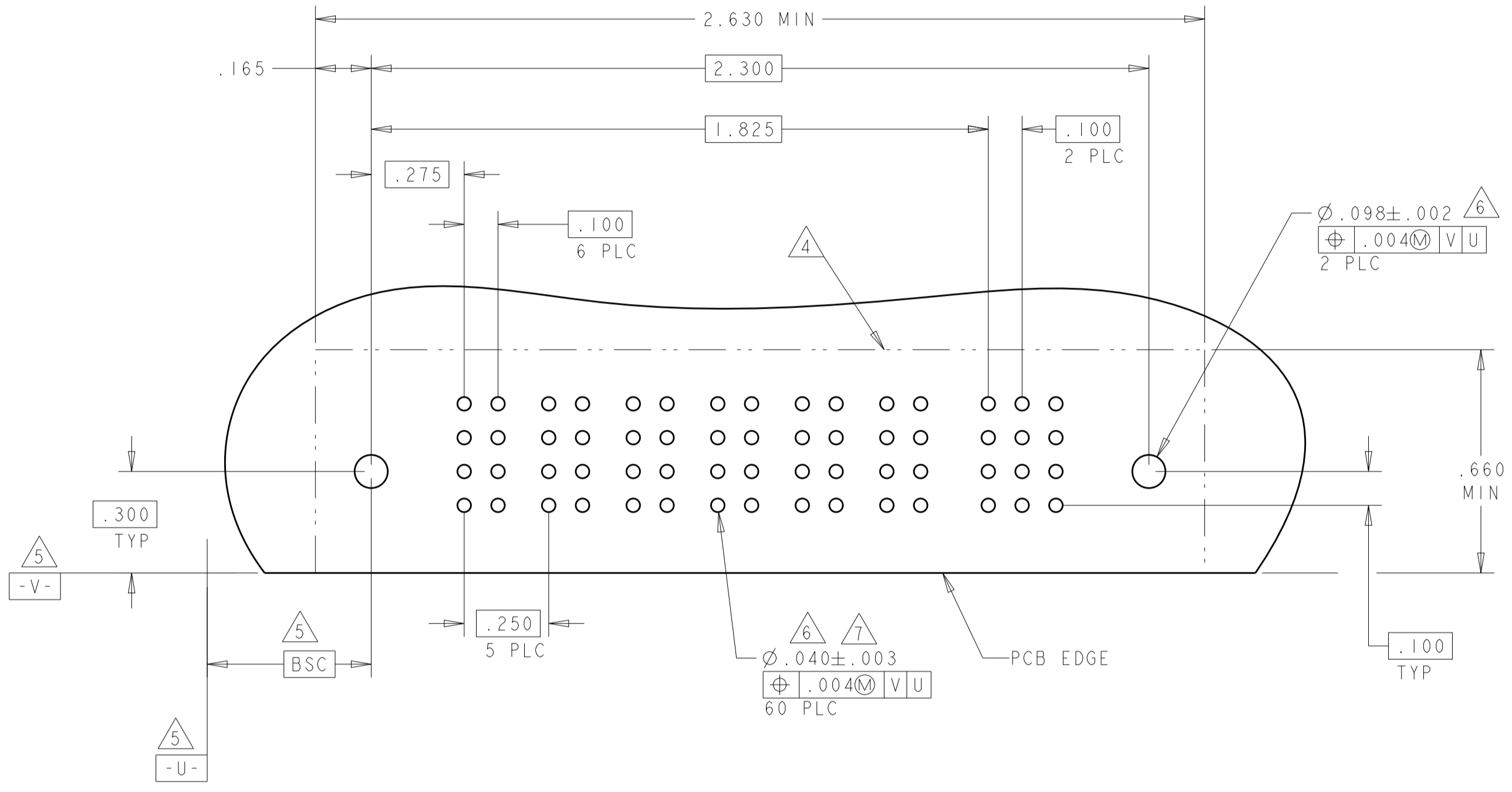

PART NUMBER	ROWS	POWER										SIGNAL			
		P1	P2	P3	P4	P5	P6	P7	P8	P9	P10	1	2	3	4
2-6450122-2	D	PM	PM	PM	PM	PM	PM	PM	PM	PM	PM	J	J	J	J
	C											K	K	K	K
	B											N	N	N	N
	A											S	S	S	S
10P + 16S		HD													HD

THIS DRAWING IS A CONTROLLED DOCUMENT.		OWN: R. GRZYBOWSKI 02FEB05	 TE Connectivity
DIMENSIONS: INCHES		CHK: M. PERCHERKE 02FEB05	
TOLERANCES UNLESS OTHERWISE SPECIFIED:		APVD: M. PERCHERKE	NAME: RIGHT ANGLE HEADER ASSY W/GUIDES MULTI-BEAM XL
0 PLC ± .010 1 PLC ± .008 2 PLC ± .005 3 PLC ± .003 4 PLC ± .002 ANGLES ± .020		PRODUCT SPEC: 108-1973	
MATERIAL: -		APPLICATION SPEC: 114-13038	SIZE: A100779
FINISH: -		WEIGHT: -	CAGE CODE: C=6450122
CUSTOMER DRAWING		SCALE: 4:1	SHEET: 6 OF 10

LOC	DIST	REVISIONS			
GP	00	REV	DATE	BY	APPV
		1			
		2			
		3			
		4			
		5			
		6			
		7			
		8			
		9			
		10			
		11			
		12			
		13			
		14			
		15			
		16			
		17			
		18			
		19			
		20			

PART NUMBER	ROWS	POWER						SIGNAL				
		P1	P2	P3	P4	P5	P6	1	2	3	4	5
2-6450122-3	D C B A	PM	PM	PM	PM	PM	PM	J	J	J	J	J
								K	K	K	K	K
								N	N	N	N	N
6P + 20S	HD	HD	HD	HD	HD	HD	HD	S	S	S	S	S

PART NUMBER	ROWS	POWER		SIGNAL																					
		P1	P2	1	2	3	4	5	6	7	8	9	10	11	12	13	14	15	16	17	18	19			
2-6450122-4	D C B A	PA	PA	Z	Z	Z	Z	Z	Z	Z	Z	Z	Z	Z	Z	Z	Z	Z	Z	Z	Z	Z	Z		
				Y	Y	Y	Y	Y	Y	Y	Y	Y	Y	Y	Y	Y	Y	Y	Y	Y	Y	Y	Y	Y	Y
				R	R	R	R	R	R	R	R	R	R	R	R	R	R	R	R	R	R	R	R	R	R
2P + 76S	HD	HD	HD	O	O	O	O	O	O	O	O	O	O	O	O	O	O	O	O	O	O	O	O	O	

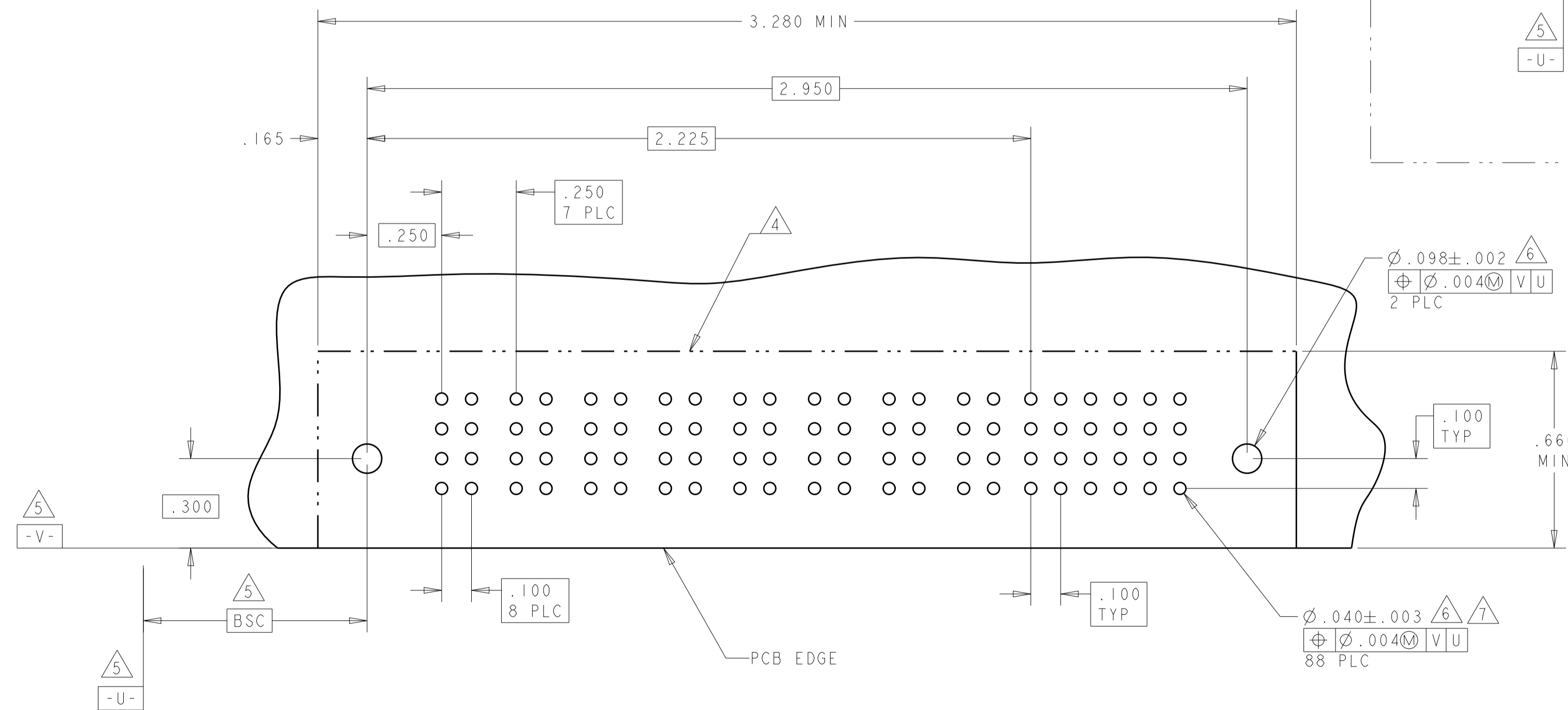
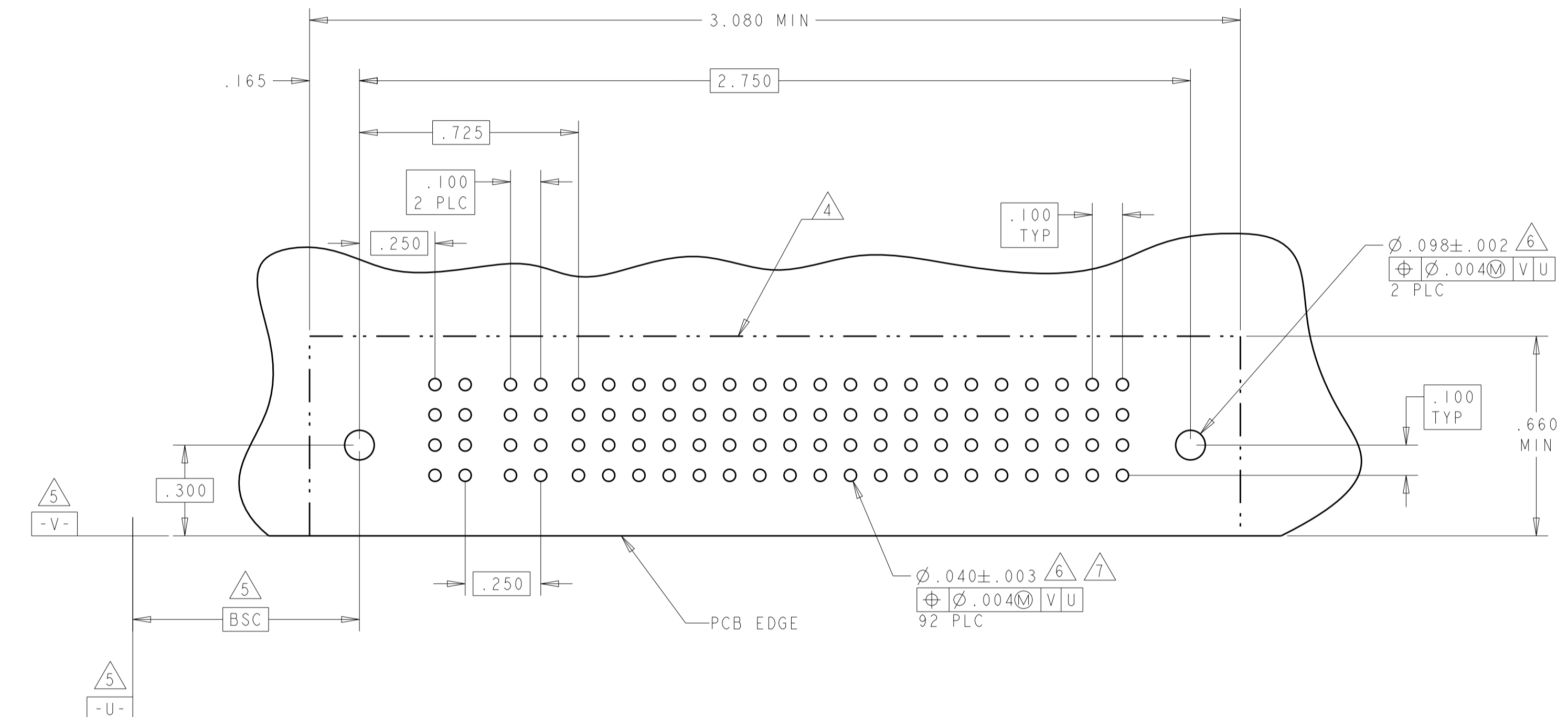
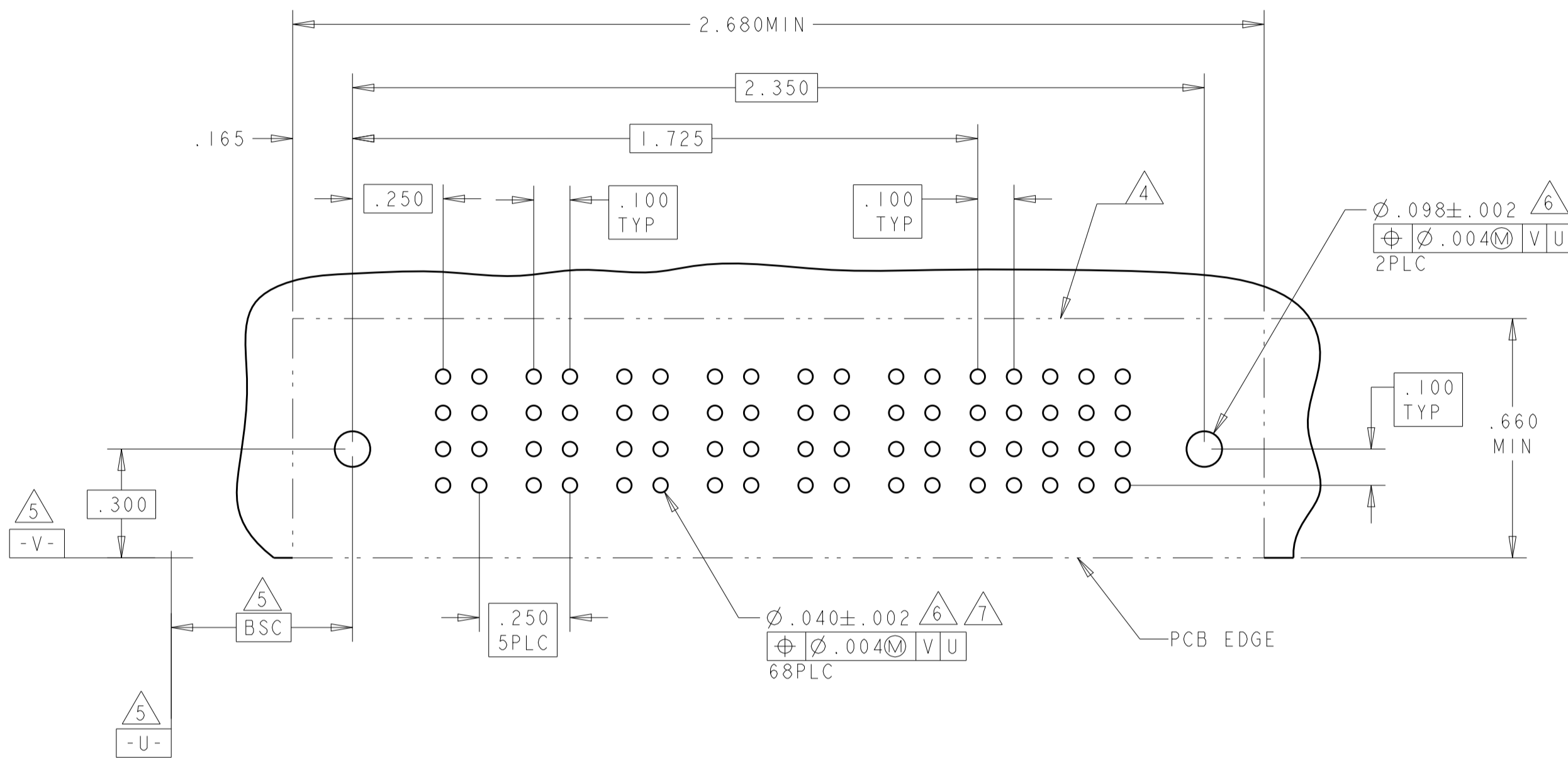

PART NUMBER	ROWS	POWER								SIGNAL					
		P1	P2	P3	P4	P5	P6	P7	P8	1	2	3	4	5	6
2-6450122-5	D C B A	PM	PM	PM	PM	PM	PM	PM	PM	J	J	J	J	J	J
										K	K	K	K	K	K
										N	N	N	N	N	N
8P + 24S	HD	HD	HD	HD	HD	HD	HD	HD	HD	S	S	S	S	S	S

THIS DRAWING IS A CONTROLLED DOCUMENT.		OWN: R. GRZYBOWSKI 02FEB05	 TE Connectivity
DIMENSIONS: INCHES		CHK: M. PERCHERKE 02FEB05	
TOLERANCES UNLESS OTHERWISE SPECIFIED:		APVD: M. PERCHERKE	NAME: RIGHT ANGLE HEADER ASSY W/GUIDES MULTI-BEAM XL
0 PLC ±.01 2 PLC ±.01 3 PLC ±.01 4 PLC ±.005 ANGLES ±.0020		PRODUCT SPEC: 108-1973	SIZE: A1
MATERIAL: FINISH:		APPLICATION SPEC: 114-13038	CAGE CODE: 6450122
		WEIGHT:	SCALE: 4:1
		CUSTOMER DRAWING	SHEET 7 OF 10

LOC	DIST	REVISIONS			
P	LTN	DESCRIPTION	DATE	DMN	APVD
-	-	SEE SHEET 1	-	-	-

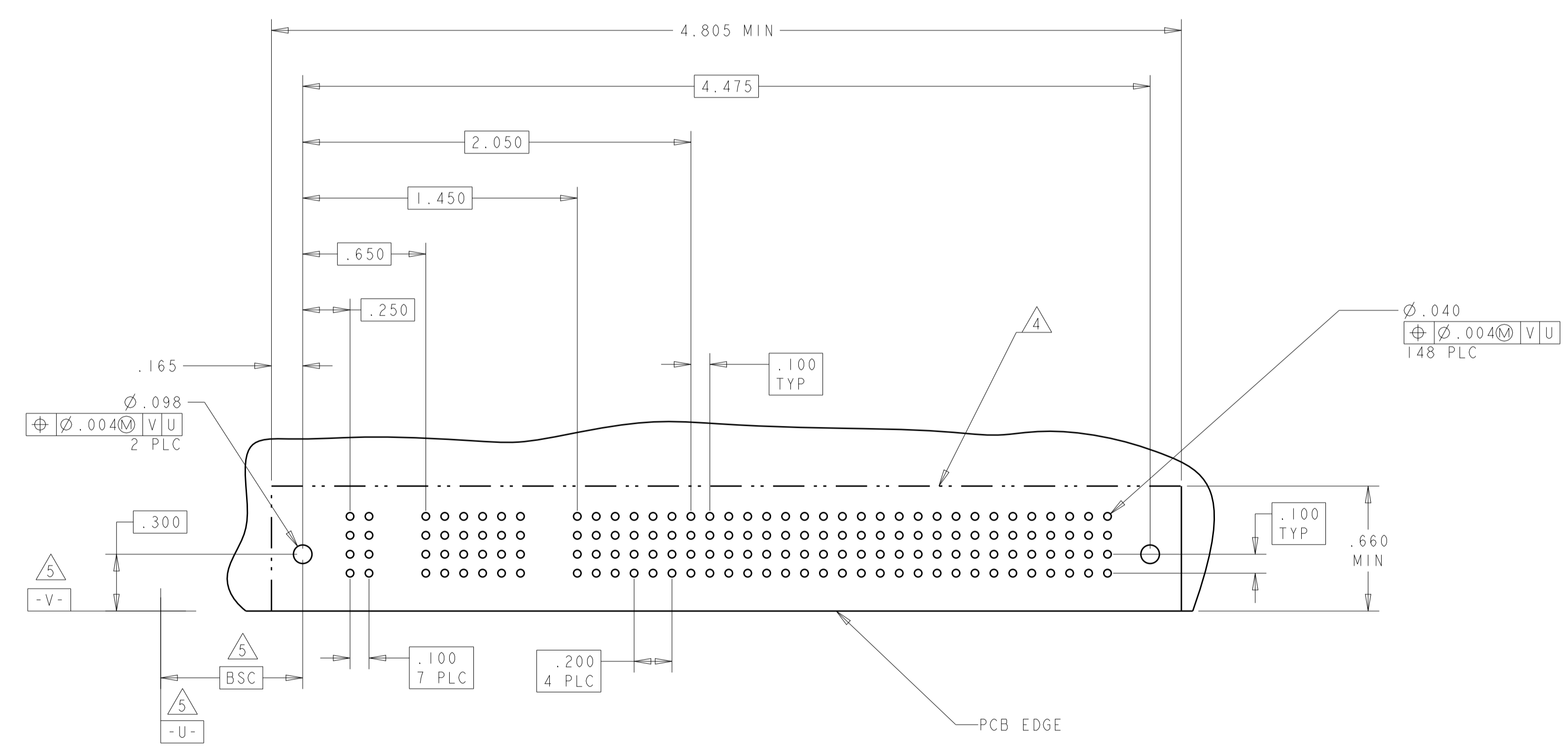
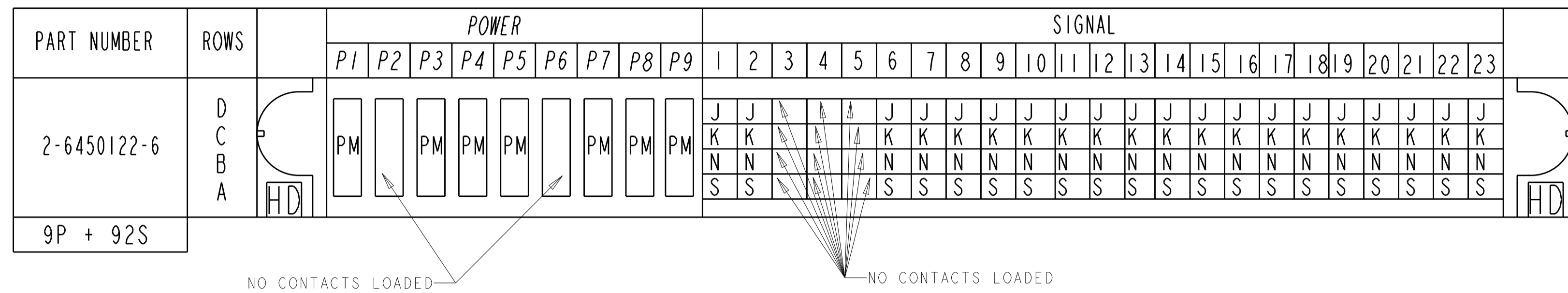

THIS DRAWING IS A CONTROLLED DOCUMENT.		OWN: R. GRZYBOWSKI 02FEB05	TE Connectivity
DIMENSIONS: INCHES		CHK: M. PERCHERKE 02FEB05	
TOLERANCES UNLESS OTHERWISE SPECIFIED: 0 PLC ±. 1 PLC ±.01 2 PLC ±.01 3 PLC ±.005 4 PLC ±.0020 ANGLES ±.2		APVD: M. PERCHERKE	NAME: RIGHT ANGLE HEADER ASSY W/GUIDES MULTI-BEAM XL
MATERIAL: -		FINISH: -	PRODUCT SPEC: 108-1973
SCALE: 4:1		WEIGHT: -	APPLICATION SPEC: 114-13038
SHEET 8 OF 10		RESTRICTED TO: -	SIZE: A1
CUSTOMER DRAWING		SCALE: 4:1	CAGE CODE: 6450122
REV: E9		DATE: -	



LOC		DIST		REVISONS			
GP	00	P	LTN	DESCRIPTION	DATE	DWN	APVD
		-		SEE SHEET 1			

PART NUMBER	ROWS	POWER	SIGNAL	
			1	2
2-6450122-7	D	PM	J	J
	C	PM	K	K
	B	PM	N	N
	A	PM	S	S
6P + 8S				

PART NUMBER	ROWS	POWER	SIGNAL	
			1	2
2-6450122-8	D	PM	J	J
	C	PM	K	K
	B	PM	N	N
	A		S	S
3P + 8S				

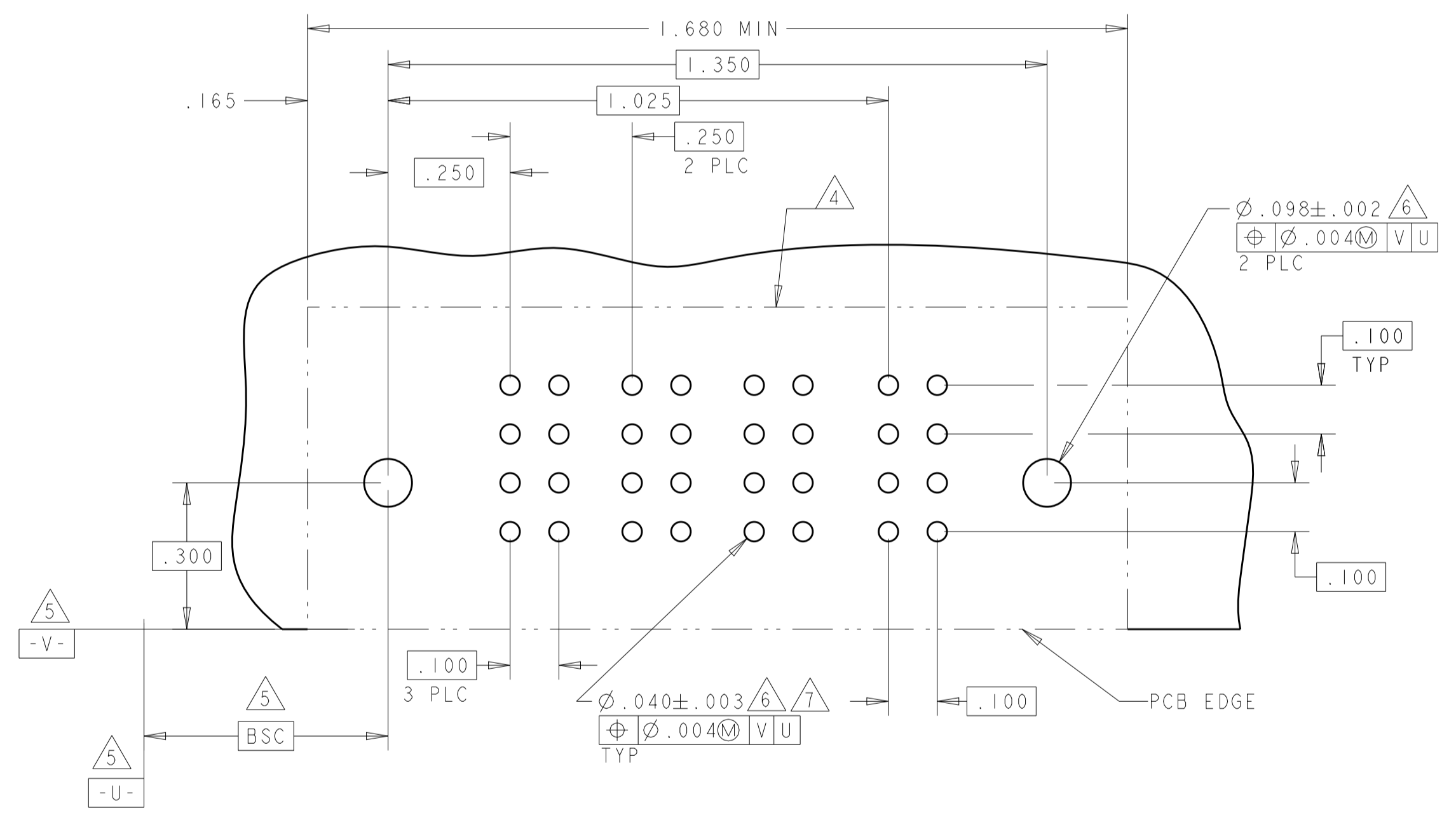
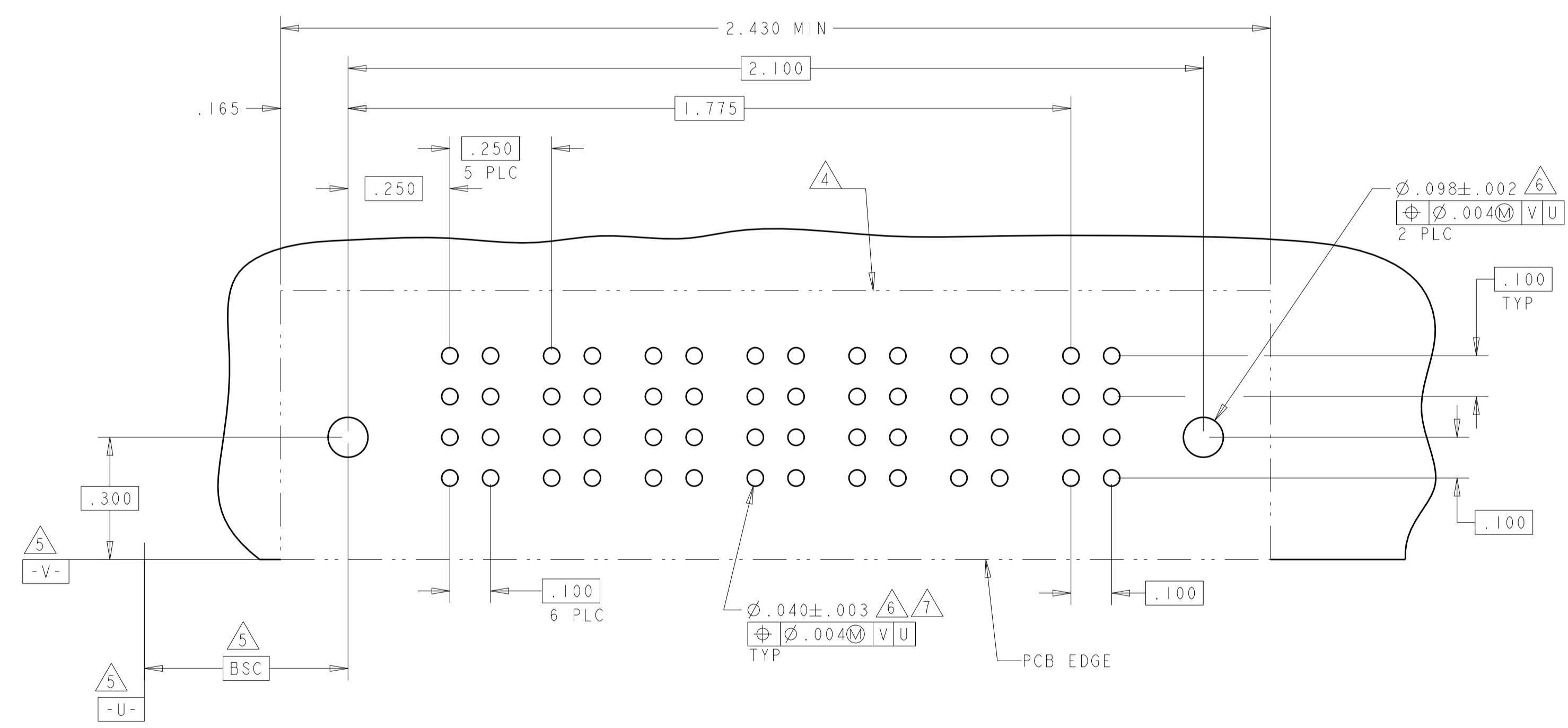

THIS DRAWING IS A CONTROLLED DOCUMENT.		DWN: R. GRZYBOWSKI 02FEB05	TE Connectivity
DIMENSIONS: INCHES		CHK: M. PERCHERKE 02FEB05	
TOLERANCES UNLESS OTHERWISE SPECIFIED: 0 PLC ±. 1 PLC ±.01 2 PLC ±.01 3 PLC ±.005 4 PLC ±.0020 ANGLES ±.2		APVD: M. PERCHERKE	NAME: RIGHT ANGLE HEADER ASSY W/GUIDES MULTI-BEAM XL
MATERIAL: -		PRODUCT SPEC: 108-1973	SIZE: CAGE CODE DRAWING NO: A100779C=6450122
FINISH: -		APPLICATION SPEC: 114-13038	RESTRICTED TO: -
CUSTOMER DRAWING		WEIGHT: -	SCALE: 4:1 SHEET 9 OF 10 REV: E9

LOC	DIST	REV	DATE	BY	APPV
GP	00				
REVISIONS					
DESCRIPTION					
- SEE SHEET 1					

PART NUMBER	ROWS	POWER						SIGNAL							
		P1	P2	P3	P4	P5	P6	1	2	3	4	5	6		
2-6450122-9	D	HD	PM	PM	PM	PM	J	J	J	J	J	J	J		
	C						K	K	K	K	K	K	K	K	K
	B						N	N	N	N	N	N	N	N	N
A	S	S	S	S	S	S	S	S	S	S	S	S			
6P + 24S		HD		HD											

NO CONTACTS LOADED

PART NUMBER	ROWS	POWER				SIGNAL				
		P1	P2	P3	P4	1	2	3	4	
3-6450122-0	D	HD	PM	PM	PM	PM	J	J	J	J
	C						K	K	K	K
	B						N	N	N	N
A	S	S	S	S	S					
4P + 16S		HD		HD						

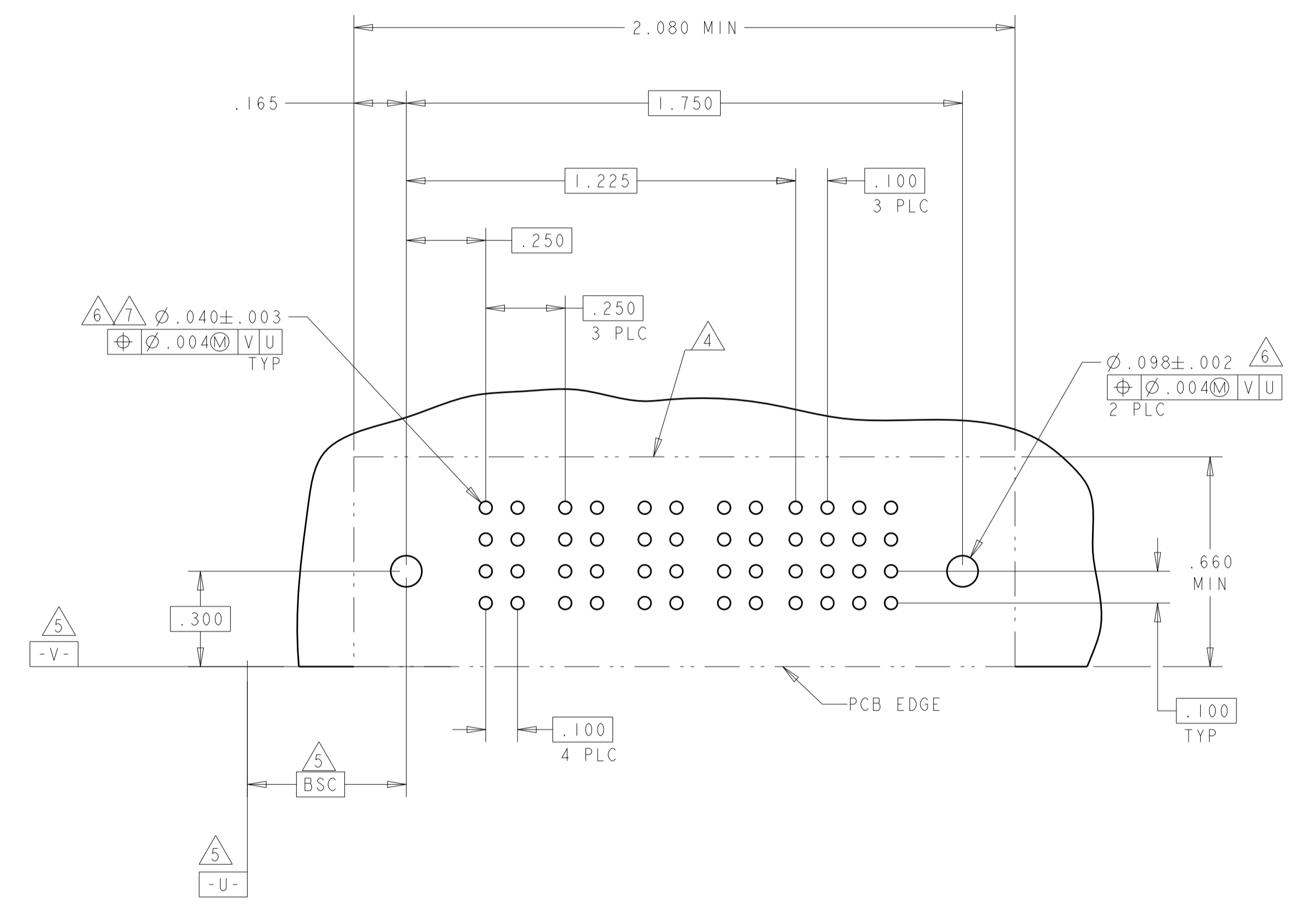
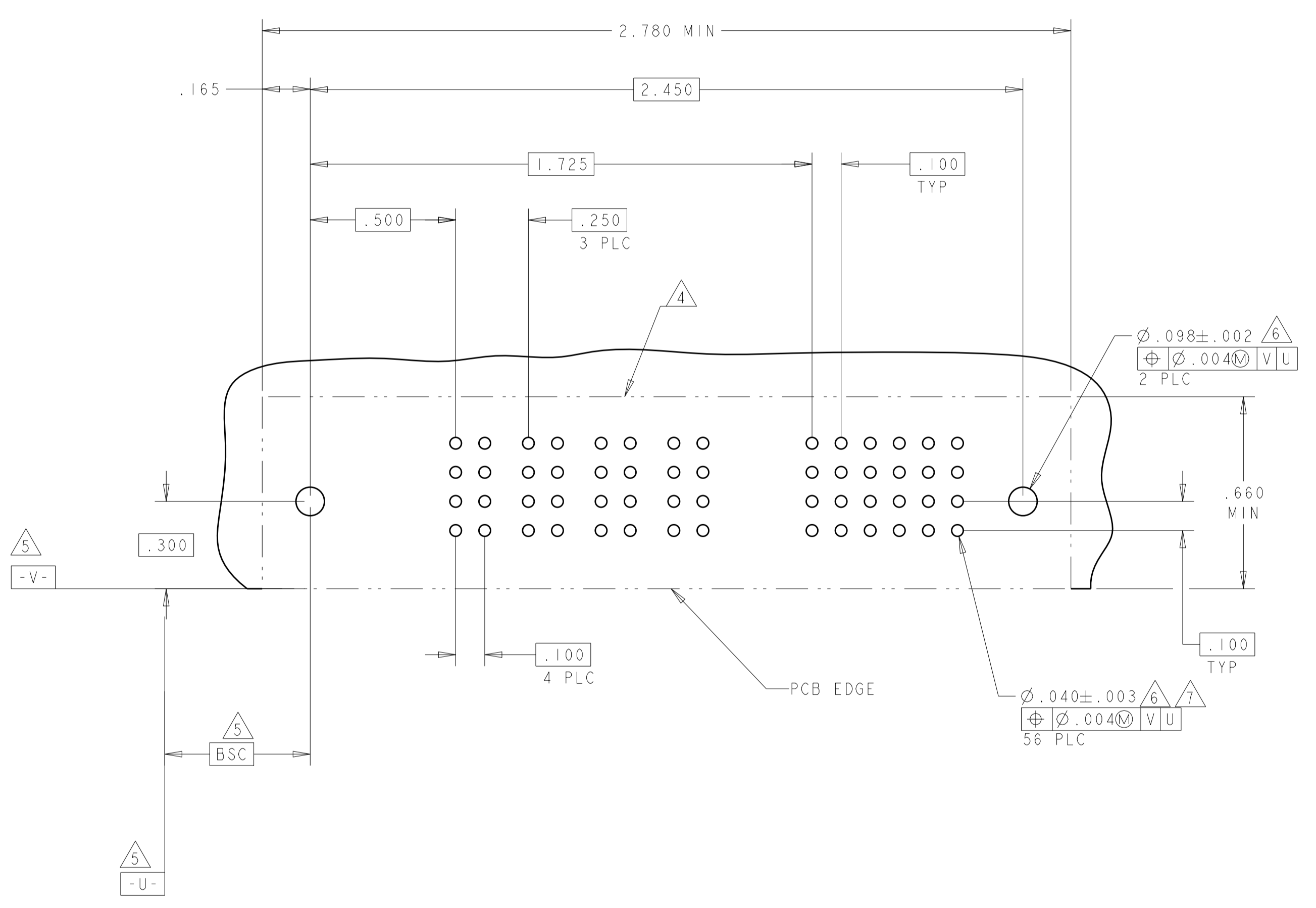

THIS DRAWING IS A CONTROLLED DOCUMENT.		OWN: R. GRZYBOWSKI 02FEB05	 TE Connectivity
DIMENSIONS: INCHES		CHK: M. PERCHERKE 02FEB05	
TOLERANCES UNLESS OTHERWISE SPECIFIED:		APVD: M. PERCHERKE	NAME: RIGHT ANGLE HEADER ASSY W/GUIDES MULTI-BEAM XL
0 PLC ±.01 1 PLC ±.01 2 PLC ±.01 3 PLC ±.005 4 PLC ±.0020 ANGLES ±.2		PRODUCT SPEC: 108-1973	SIZE: A1
MATERIAL: -		APPLICATION SPEC: 114-13038	CAGE CODE: -
FINISH: -		WEIGHT: -	DRAWING NO: 6450122
		CUSTOMER DRAWING	SCALE: 4:1 SHEET 10 OF 10 REV: E9

单击下面可查看定价，库存，交付和生命周期等信息

[>>TE Connectivity\(泰科\)](#)