

THIS DRAWING IS UNPUBLISHED. RELEASED FOR PUBLICATION
 © COPYRIGHT copyright.d8Te ALL RIGHTS RESERVED.

REVISIONS				
P	LTR	DESCRIPTION	DATE	APVD
A1		REVISED PER ECR-20-100939	15DEC2020	SK DZ

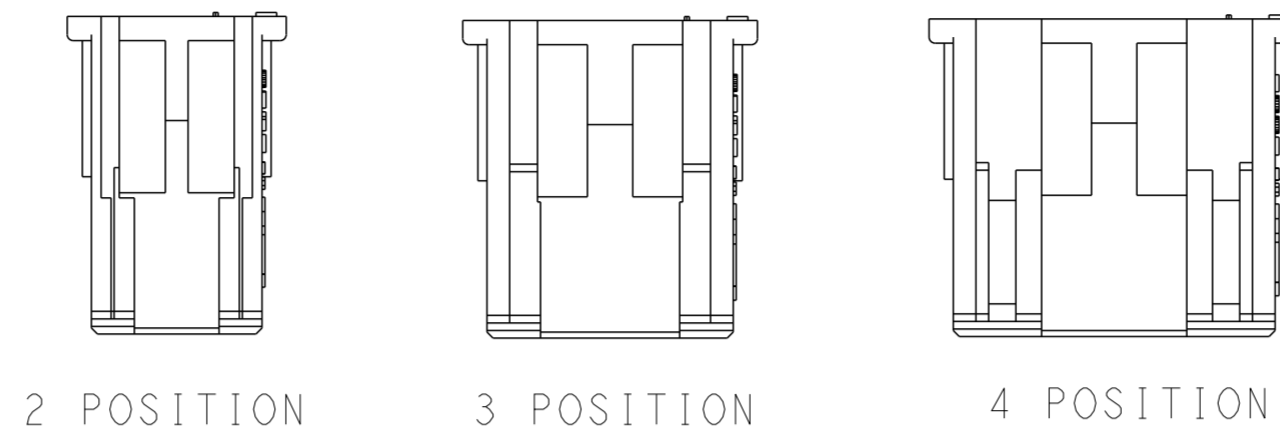

- 1 MATERIAL: NYLON UL94-V0
COLOR: SEE BELOW TABLE.
- 2 ACCEPTS TE RECEPTACLE
P/N'S 2110989-()
- 3 THESE HOUSINGS CAN ACCEPT
OPTIONAL TPA (RETAINER)
P/N 1969443-().
- 4 MATES WITH TE HEADER ASSEMBLIES
2338244-() & 2338245-()

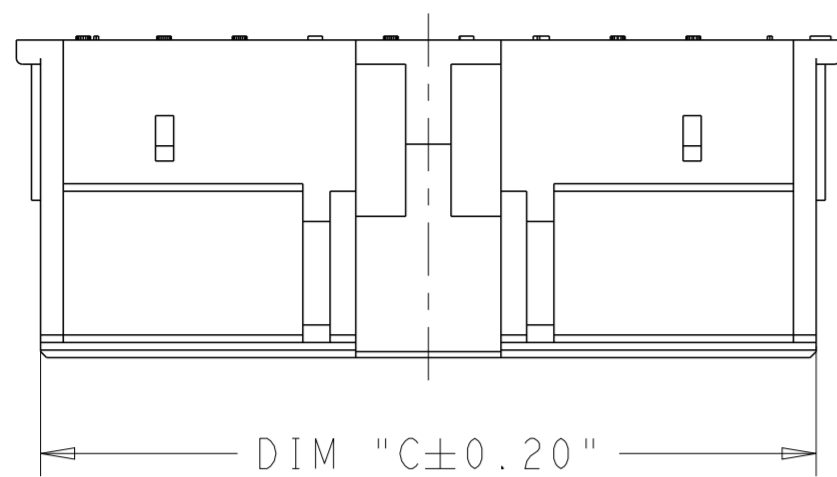
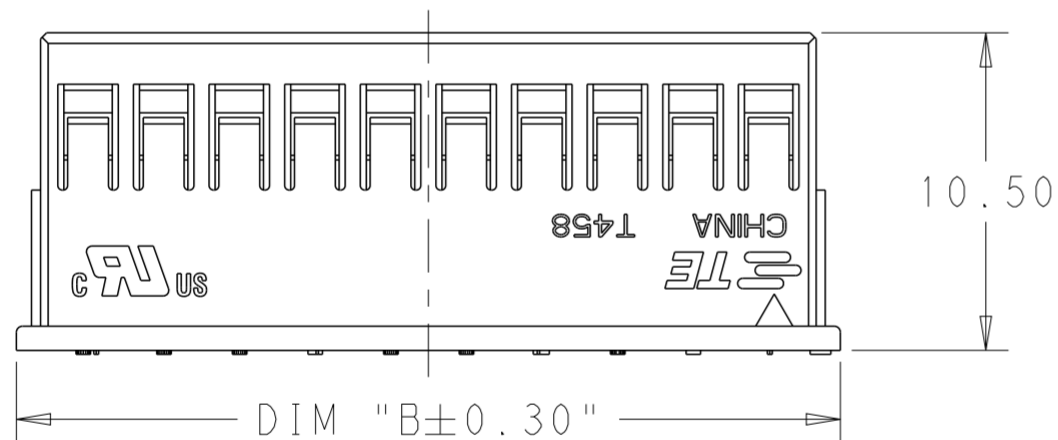
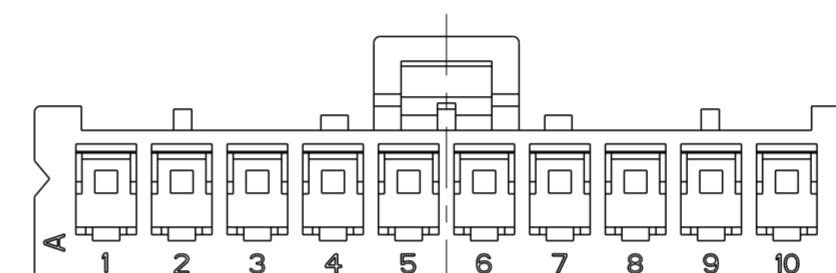
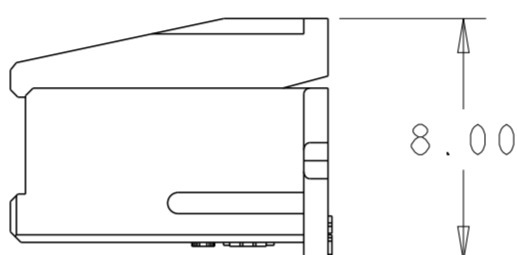
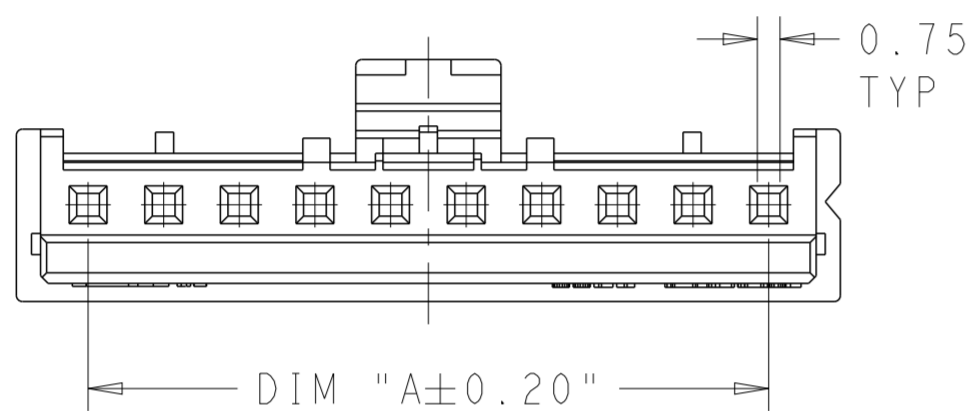

50.64	52.3	47.5	20	2-2338183-0	4-2338183-0	6-2338183-0	8-2338183-0	2338183-1
48.14	49.8	45.0	19	1-2338183-9	3-2338183-9	5-2338183-9	7-2338183-9	9-2338183-9
45.64	47.3	42.5	18	1-2338183-8	3-2338183-8	5-2338183-8	7-2338183-8	9-2338183-8
43.14	44.8	40.0	17	1-2338183-7	3-2338183-7	5-2338183-7	7-2338183-7	9-2338183-7
40.64	42.3	37.5	16	1-2338183-6	3-2338183-6	5-2338183-6	7-2338183-6	9-2338183-6
38.14	39.8	35.0	15	1-2338183-5	3-2338183-5	5-2338183-5	7-2338183-5	9-2338183-5
35.64	37.3	32.5	14	1-2338183-4	3-2338183-4	5-2338183-4	7-2338183-4	9-2338183-4
33.14	34.8	30.0	13	1-2338183-3	3-2338183-3	5-2338183-3	7-2338183-3	9-2338183-3
30.64	32.3	27.5	12	1-2338183-2	3-2338183-2	5-2338183-2	7-2338183-2	9-2338183-2
28.14	29.8	25.0	11	1-2338183-1	3-2338183-1	5-2338183-1	7-2338183-1	9-2338183-1
25.64	27.3	22.5	10	1-2338183-0	3-2338183-0	5-2338183-0	7-2338183-0	9-2338183-0
23.14	24.8	20.0	9	2338183-9	2-2338183-9	4-2338183-9	6-2338183-9	8-2338183-9
20.64	22.3	17.5	8	2338183-8	2-2338183-8	4-2338183-8	6-2338183-8	8-2338183-8
18.14	19.8	15.0	7	2338183-7	2-2338183-7	4-2338183-7	6-2338183-7	8-2338183-7
15.64	17.3	12.5	6	2338183-6	2-2338183-6	4-2338183-6	6-2338183-6	8-2338183-6
13.14	14.8	10.0	5	2338183-5	2-2338183-5	4-2338183-5	6-2338183-5	8-2338183-5
10.64	12.3	7.5	4	2338183-4	2-2338183-4	4-2338183-4	6-2338183-4	8-2338183-4
8.14	9.8	5.0	3	2338183-3	2-2338183-3	4-2338183-3	6-2338183-3	8-2338183-3
5.64	7.3	2.5	2	2338183-2	2-2338183-2	4-2338183-2	6-2338183-2	8-2338183-2
DIM C	DIM B	DIM A	NO. OF POSITIONS	PART NUMBER (RED COLOR)	PART NUMBER (BLUE COLOR)	PART NUMBER (BLACK COLOR)	PART NUMBER (YELLOW COLOR)	PART NUMBER (GREEN COLOR)

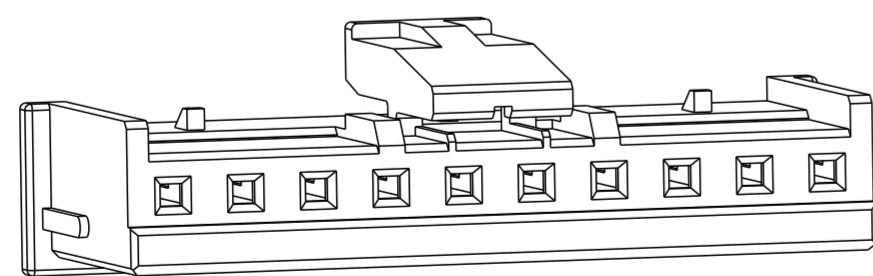

THIS DRAWING IS A CONTROLLED DOCUMENT.

DIMENSIONS: mm	TOLERANCES UNLESS OTHERWISE SPECIFIED: 0 PLC ± 1 PLC ±0.30 2 PLC ±0.25 3 PLC ± 4 PLC ±	DWN WARREN HUO 22OCT18 CHK DANIEL ZHANG 25OCT18 APVD DANIEL ZHANG 25OCT18	NAME ECONOMY POWER 2.5 TPA HOUSING COLORED, UL VERSION
MATERIAL	FINISH	PRODUCT SPEC 108-2418 APPLICATION SPEC 114-13315	SIZE A2 CAGE CODE - DRAWING NO. C-2338183
CUSTOMER DRAWING		WEIGHT -	RESTRICTED TO -
SCALE N/A		SHEET 1 OF 1	REV A1

STE TE Connectivity

单击下面可查看定价，库存，交付和生命周期等信息

[>>TE Connectivity\(泰科\)](#)