

REVISIONS					
P	LTR	DESCRIPTION	DATE	DWR	APVD
1		PRELIMINARY ISSUE	05-03-99	MH	FWK
2		EB00-0212-99	16-04-99	MH	FWK
3		EB00-0223-99	14-05-99	MH	FWK
4		EB00-0285-99	11-06-99	MH	FWK
5		EB00-0398-99	30-07-99	MH	FWK
6		EB00-0434-99	25-08-99	MH	

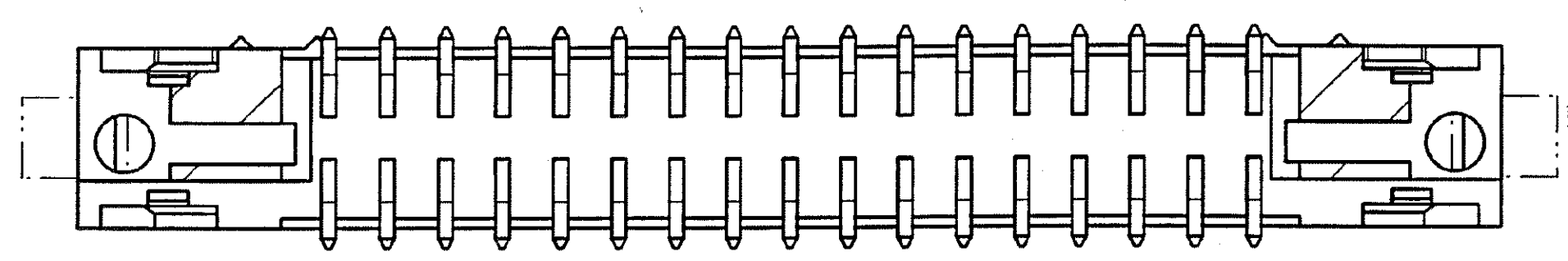

RECOMMENDED AREA FOR GLUEING (BOTH ENDS).

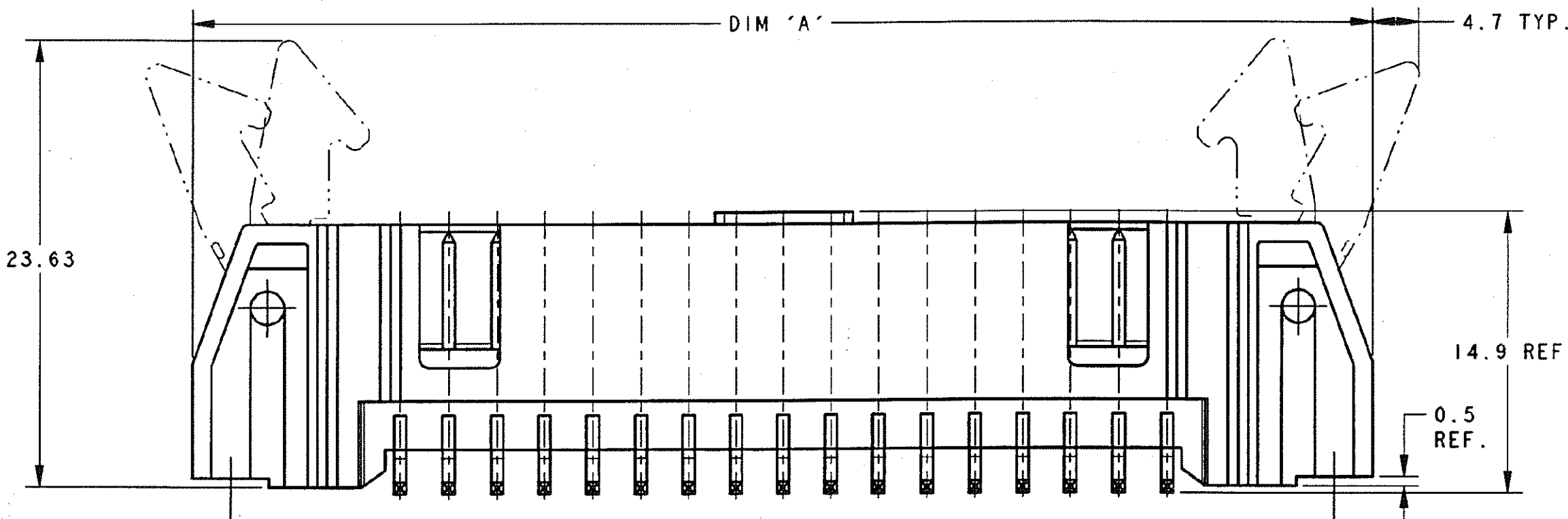
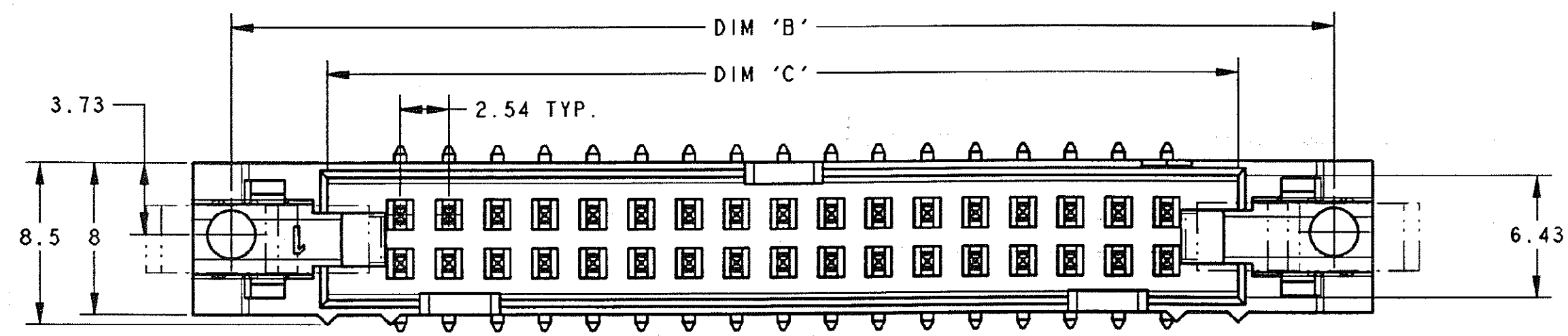
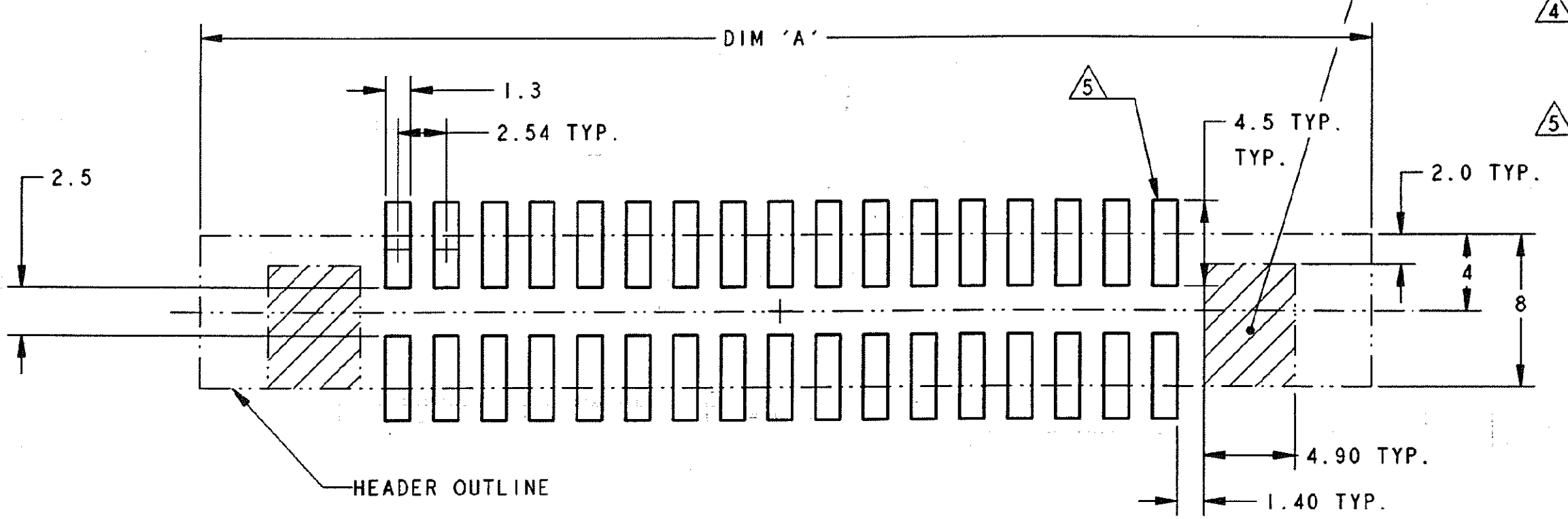

RECOMMENDED MINIMUM P.C.B. FOOTPRINT

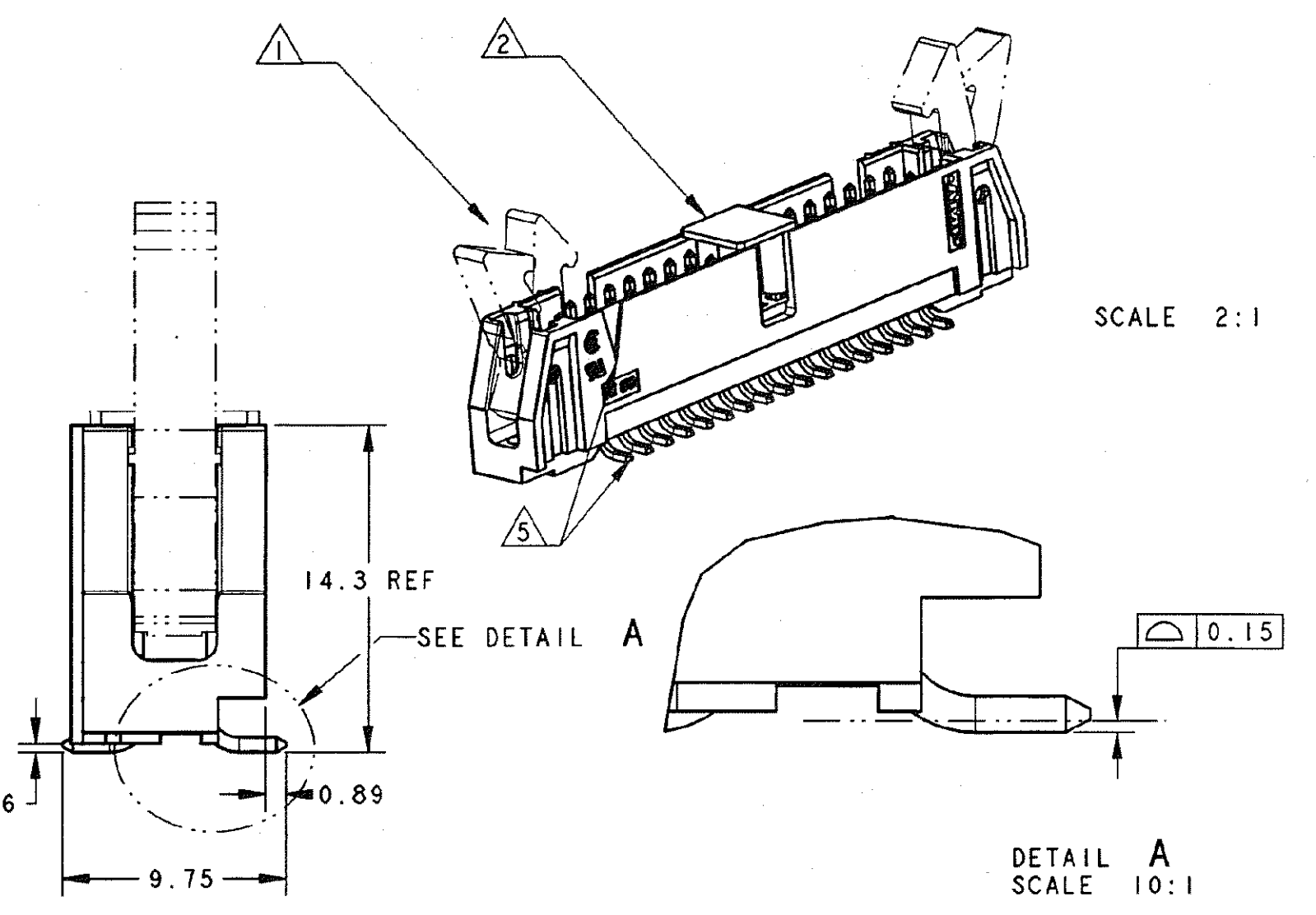

- 1 EJECTOR ARM, PART NUMBER 111293-1, NOT FITTED. TO BE FITTED AFTER ASSY TO PC BOARD.
- 2 PICK AND PLACE ADAPTER TO BE DISCARDED AFTER SOLDERING CONNECTOR TO PCB.
- 3. PRODUCT TO BE SUPPLIED IN PLASTIC TRAYS. SEE PACKAGING SPEC.107-3266.
- 4 MATERIAL/FINISH: -HOUSING - GF PCT TO UL94 V-0 BLACK.
 - CONTACT - BRASS PLATED WITH 0.8μm GOLD ON MATING AREA, AND 3.8μm MIN MATTE TIN LEAD ON SOLDER AREA, ALL OVER 1.27μm NICKEL UNDERPLATE.
- 5 PIN 1 IDENTIFICATION.

68.58	78.74	82.80	50	1-699975-0
48.26	58.42	62.48	34	699975-8
25.4	35.56	39.62	16	699975-3
17.78	27.94	32.00	10	699975-1
DIM 'C'	DIM 'B'	DIM 'A'	NO OF WAYS	PART NUMBER
<small>THIS DRAWING IS A CONTROLLED DOCUMENT FOR AMP INCORPORATED. IT IS SUBJECT TO CHANGE AND THE CONTROLLING ENGINEERING ORGANIZATION SHOULD BE CONTACTED FOR THE LATEST REVISION.</small>				
DIMENSIONS IN m.m TOLERANCES UNLESS OTHERWISE SPECIFIED: LINEAR: - ±0.5 ANGULAR: - ±1°		DWN M. HUGHES 5-Mar-99 CR FW-K APVD FW-K PRODUCT SPEC 108-3412 APPLICATION SPEC 114-3215 WEIGHT MATERIAL 4 FINISH 4 CUSTOMER DRAWING		
THIRD ANGLE PROJECTION		AMP of Great Britain Ltd, Stanmore, Middlesex, HA7 4RS.		
NAME UNIVERSAL HEADER, 10, 16, 34, 50 WAY SURFACE MOUNT		DRAWING NO C=699975		
SCALE 4:1		SHEET 1 OF 2 REV 6		

LOC		DIST		REVISIONS			
F	LTR	DESCRIPTION	DATE	DWN	APVD		
-	-	SEE SHEET 1	-	-	-		

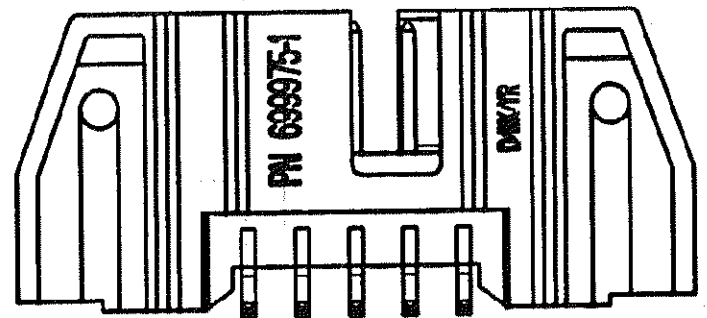

10 POSITION SURFACE MOUNT HEADER

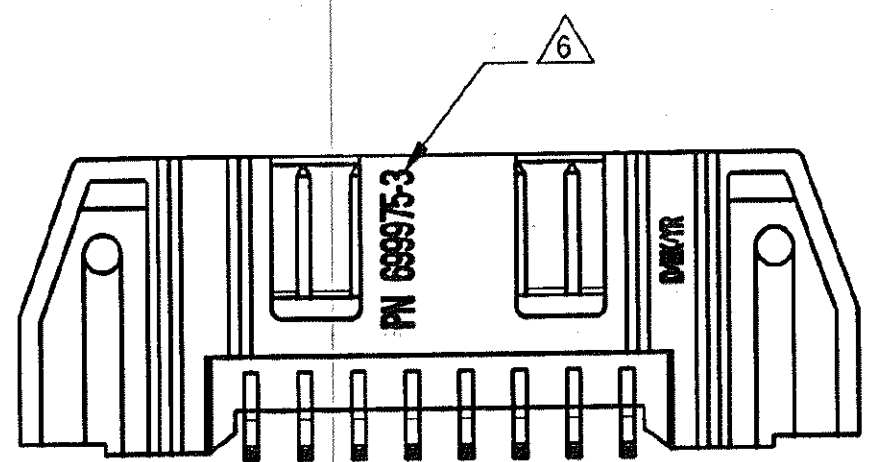

16 POSITION SURFACE MOUNT HEADER

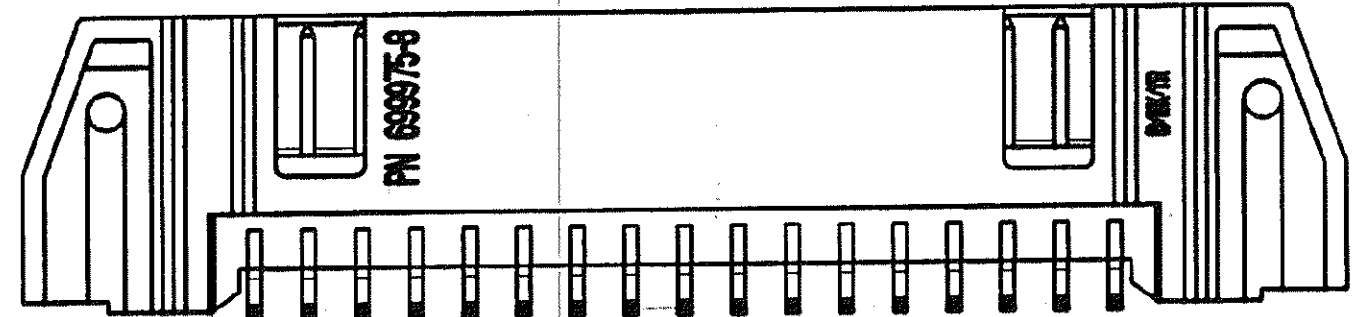

34 POSITION SURFACE MOUNT HEADER

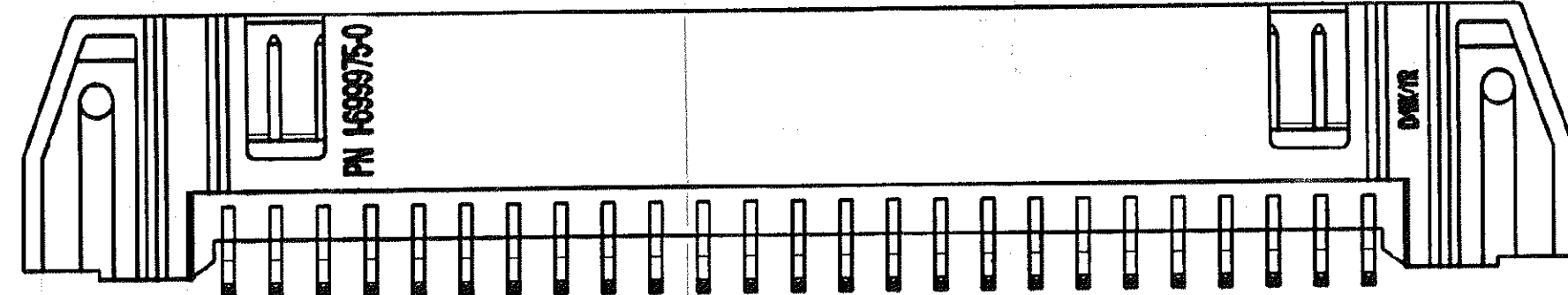

50 POSITION SURFACE MOUNT HEADER

NOTES CONT...

△ PRODUCTS ARE MARKED IN THE AREAS SHOWN WITH THE AMP PART NUMBER; CUSTOMER NUMBER (IF DESIRED) AND DATE CODE. DATE CODING COMPRISES OF DAY OF THE WEEK (D), WEEK NUMBER (WK) AND YEAR (YR).

△ FOR PRODUCT WEIGHTS, SEE TABLE BELOW.

APPROX. 10.05g	APPROX. 9.15g	50 POS. HEADER	1-699975-0
APPROX. 7.14g	APPROX. 6.25g	34 POS. HEADER	699975-8
APPROX. 4.82g	APPROX. 3.93g	16 POS. HEADER	699975-3
APPROX. 4.26g	APPROX. 3.36g	10 POS. HEADER	699975-1
WEIGHT △ (WITH LATCH ARMS)	WEIGHT △ (WITHOUT LATCH ARMS)	DESCRIPTION	PART NUMBER

THIS DRAWING IS A CONTROLLED DOCUMENT FOR AMP INCORPORATED. IT IS SUBJECT TO CHANGE AND THE CONTROLLING ENGINEERING ORGANIZATION SHOULD BE CONTACTED FOR THE LATEST REVISION.		DWN M. HUGHES	5-MAR-99	AMP AMP of Great Britain Ltd, Stanmore, Middlesex, HA7 4RS.	
DIMENSIONS IN m.m	TOLERANCES UNLESS OTHERWISE SPECIFIED:	CHK F.W-K	-	NAME	
THIRD ANGLE PROJECTION	LINEAR: - ±0.5 ANGULAR: - ±1°	APVD F.W-K	-	UNIVERSAL HEADER, 10; 16; 34; 50 WAY SURFACE MOUNT	
MATERIAL	FINISH	PRODUCT SPEC 108-3412	SIZE A2	CAGE CODE 00779	DRAWING NO 699975
△	△	APPLICATION SPEC 114-3215	SCALE 3:1	SHEET 2	REV 6
CUSTOMER DRAWING					

单击下面可查看定价，库存，交付和生命周期等信息

[>>TE Connectivity\(泰科\)](#)