



2400-2500 & 5150-5875 MHz DUAL BAND ANTENNA

Standard Antenna Solutions

802.11 a/b/g/n, Wi-Fi 4-6, includes frequencies of Bluetooth, ZigBee, and Wi-Fi products

Part Number: 4-1982564-1

PRODUCT FACTS:

- External chassis mount antenna
- Requires snap in feature in plastic housing or mounting clip
- Dual band dipole antenna
- No adapter cable needed
- Manipulation protected
- Customizable cable and connector
- RoHS compliant

SPECIFICATIONS:

- Frequency Range:
 - 2400-2500 MHz; 5150-5875 MHz
- Peak Gain:
 - 0.0 dBi @ 2400-2500 MHz
 - 1.0 dBi @ 5150-5875 MHz
- VSWR: <2.0:1
- Return Loss: <-10.0 dB
- Azimuth Beam Width: Omni directional
- Feed Point Impedance: 50 ohms
- Power Handling: 10 Watt cw
- Size: 104 x 9.38 mm
- Weight: 8g
- Keep Out Area: External antenna
- Cable: 1.13 mm dia., 190 mm length
- Connector: IPEX MHF 1 compatible plug
- Operating Temperature: -30° to 75°C

VSWR:

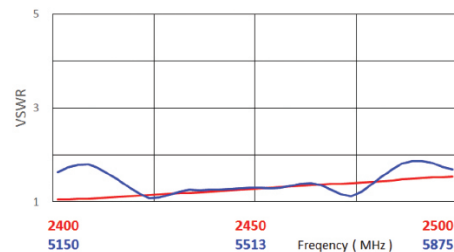

RETURN LOSS:

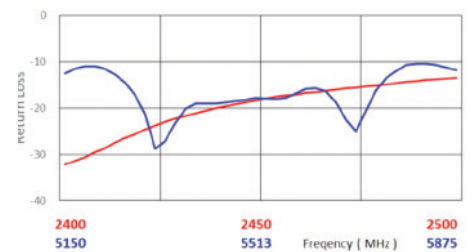

EFFICIENCY:

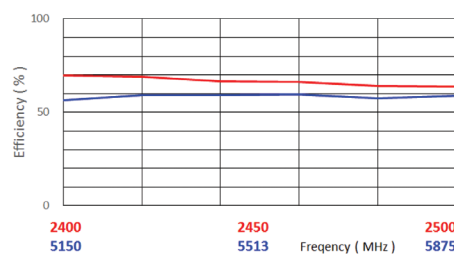

TEST ORIENTATION IN FREE SPACE:

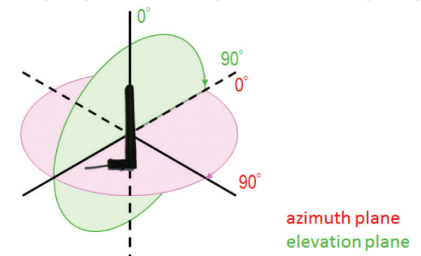

AZIMUTH:

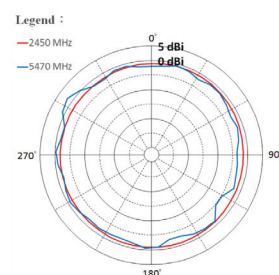

ELEVATION:

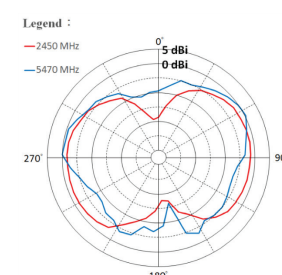

2400-2500 & 5150-5875 MHz Dual Band Antenna

Standard Antenna Solutions

DIMENSIONS:

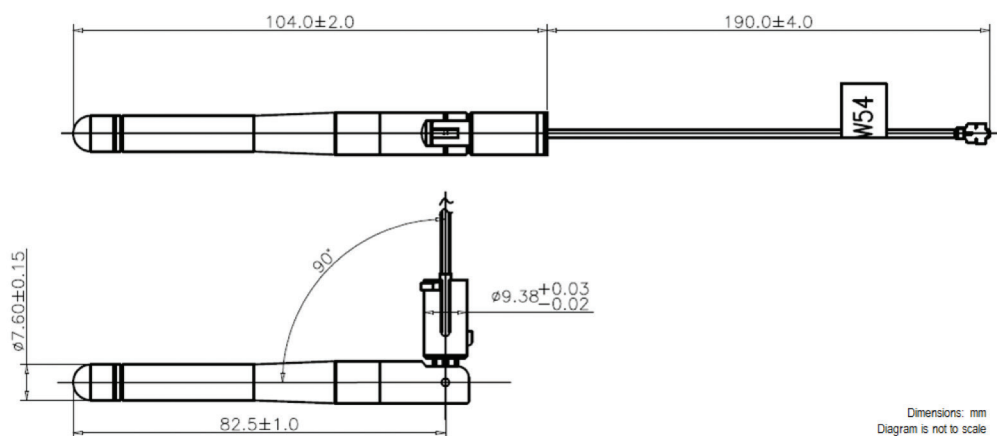

TE TECHNICAL SUPPORT CENTER

USA:	+1 (800) 522-6752
Canada:	+1 (905) 475-6222
Mexico:	+52 (0) 55-1106-0800
Latin/S. America	+54 (0) 11-4733-2200
Germany:	+49 (0) 6251-133-1999
UK:	+44 (0) 800-267666
France:	+33 (0) 1-3420-8686
Netherlands:	+31 (0) 73-6246-999
China:	+86 (0) 400-820-6015

For phone numbers in other countries, go to te.com/support-center

te.com

TE Connectivity, TE Connectivity (logo) and Every Connection Counts are trademarks. All other logos, products and/or company names referred to herein might be trademarks of their respective owners.

The information given herein, including drawings, illustrations and schematics which are intended for illustration purposes only, is believed to be reliable. However, TE Connectivity makes no warranties as to its accuracy or completeness and disclaims any liability in connection with its use. TE Connectivity's obligations shall only be as set forth in TE Connectivity's Standard Terms and Conditions of Sale for this product and in no case will TE Connectivity be liable for any incidental, indirect or consequential damages arising out of the sale, resale, use or misuse of the product. Users of TE Connectivity products should make their own evaluation to determine the suitability of each such product for the specific application.

© 2019 TE Connectivity Ltd. family of companies All Rights Reserved.

1-1773975-3 05/19 Original

单击下面可查看定价，库存，交付和生命周期等信息

[>>TE Connectivity\(泰科\)](#)