

LOC		DIST		REVISIONS			
P	LTN	DESCRIPTION	DATE	DMN	APVD		
G		REV PER ECO 15-010033	7-10-15	CT	DH		

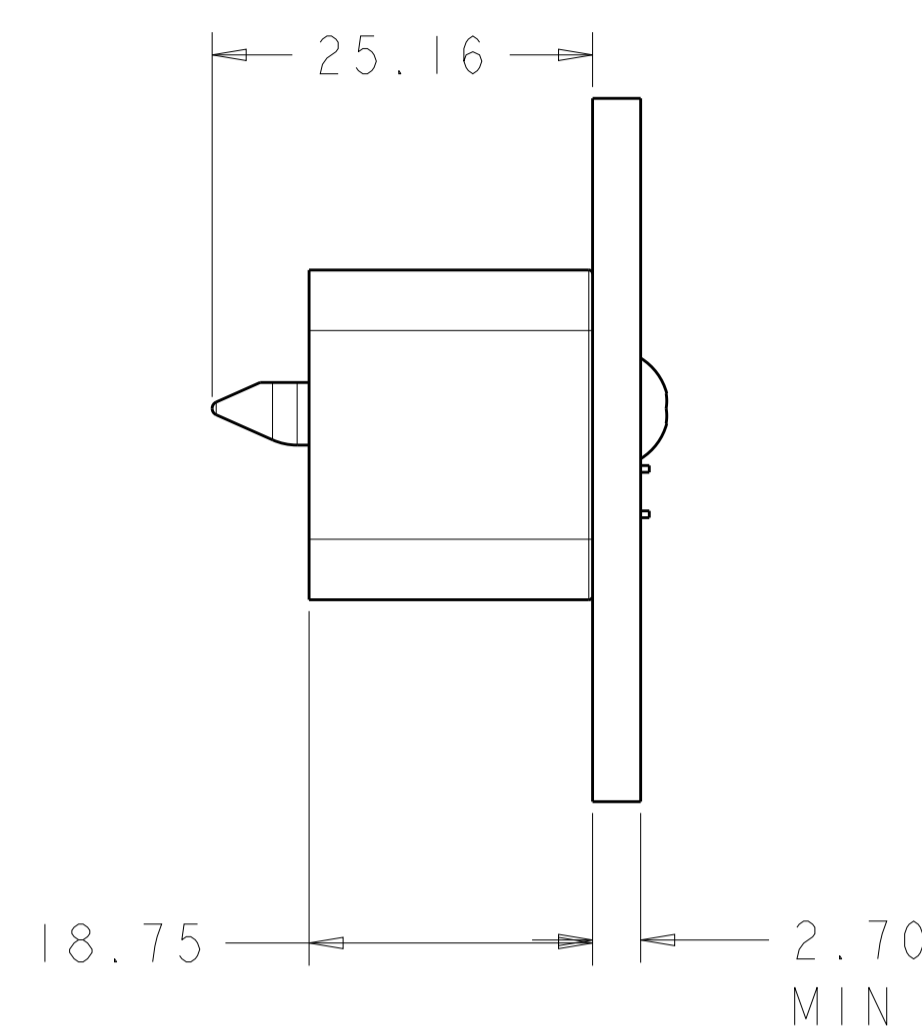

- MATING CONNECTOR FOR THIS CONNECTOR IS 2000979.
- MATERIAL- SHELL: ALUMINUM
HOUSING: GLASS FILLED POLYESTER, UL94VO
RETAINING RING: STAINLESS STEEL
KEYING GUIDE PIN: STAINLESS STEEL
- PLATING- SHELL: ELECTROLESS NICKEL
- KEYING GUIDE PIN PACKAGED FOR ASSEMBLY BY CUSTOMER.
- PLATING- CONTACT MATING AREA:
1.27µm MIN GOLD OVER 1.27µm MIN NICKEL
CONTACT PCB AREA: 0.5µm MIN TIN OVER 1.27µm MIN NICKEL

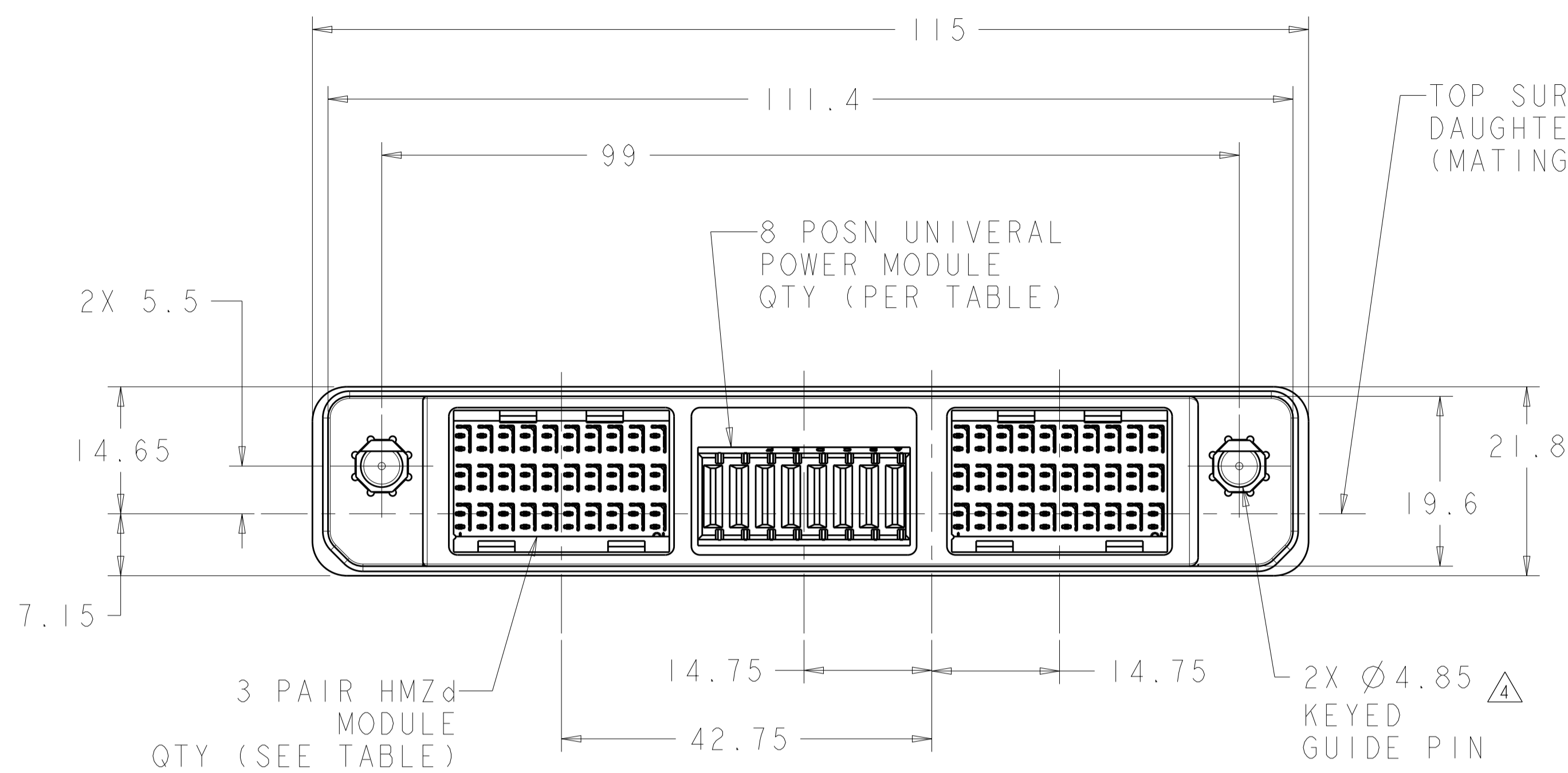
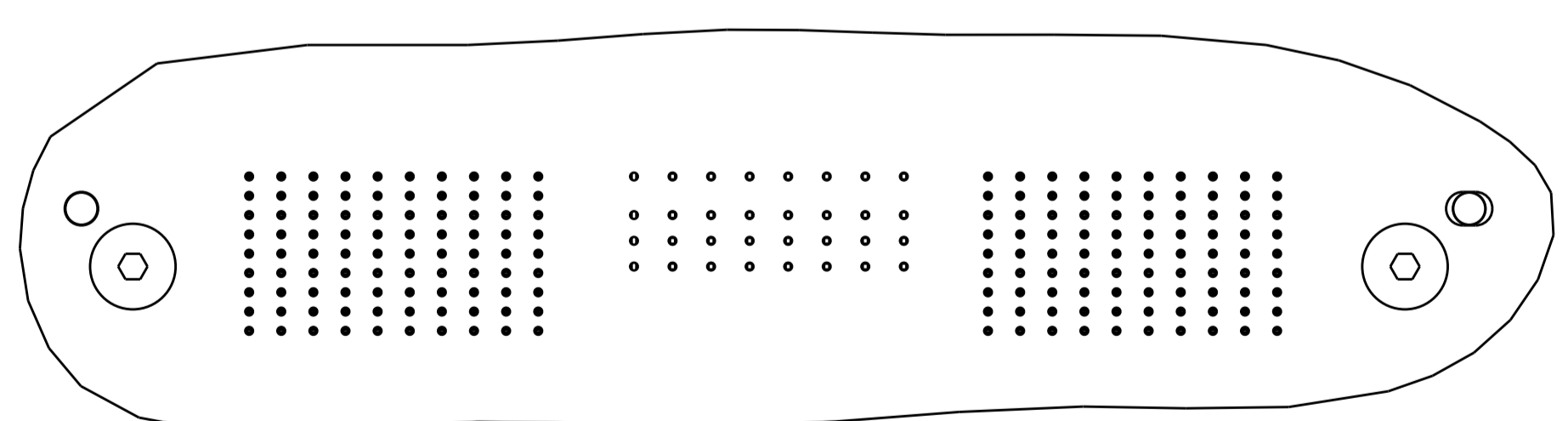
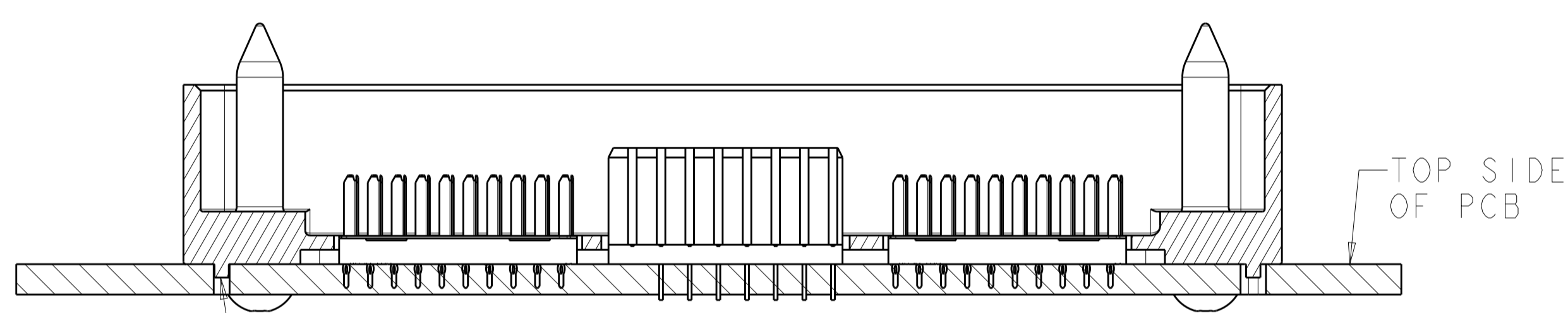

OBSOLETE
 NOT RELEASED FOR PRODUCTION

	2	1	--	--	5-2000980-4
OBSOLETE	2	1	--	--	5-2000980-3
NOT RELEASED FOR PRODUCTION	--	1	1	1	2000980-6
	--	-	-	3	2000980-5
	--	1	-	2	2000980-4
OBSOLETE	--	1	-	2	2000980-3
OBSOLETE	--	1	1	1	2000980-2
OBSOLETE	--	-	-	3	2000980-1
	3 PAIR HMZd MODULE (RoHS)	8 POSN UPM MODULE	7 POSN RF COAX MODULE	3 PAIR HMZd MODULE	PART NUMBER
MODULE QTY PER ASSY					

THIS DRAWING IS A CONTROLLED DOCUMENT. DWN: Brent D. Tolm 13JAN2010
 CHK: CHONG YI 13JAN2010
 APVD: M. R. McALONIS 13JAN2010

DIMENSIONS: mm
 TOLERANCES UNLESS OTHERWISE SPECIFIED:
 0 PLC ±0.2
 1 PLC ±0.1
 2 PLC ±0.05
 3 PLC ±0.025
 4 PLC ±
 ANGLES °

MATERIAL:

FINISH:

WEIGHT: -
 CUSTOMER DRAWING

NAME: MOTHER BOARD CONNECTOR, HIGH SPEED RUGGEDIZED (HSR), 3 BAY, UNSEALED, VERTICAL
 PRODUCT SPEC: 108-2381
 APPLICATION SPEC: -

SIZE: A1
 CAGE CODE: 00779
 DRAWING NO: C=2000980

RESTRICTED TO: -
 SCALE: 2:1
 SHEET: 1 OF 3
 REV: G

STE TE Connectivity

LOC	DIST	REV	DESCRIPTION	DATE	OWN	APVD
-	-	-	SEE SHEET 1	-	-	-

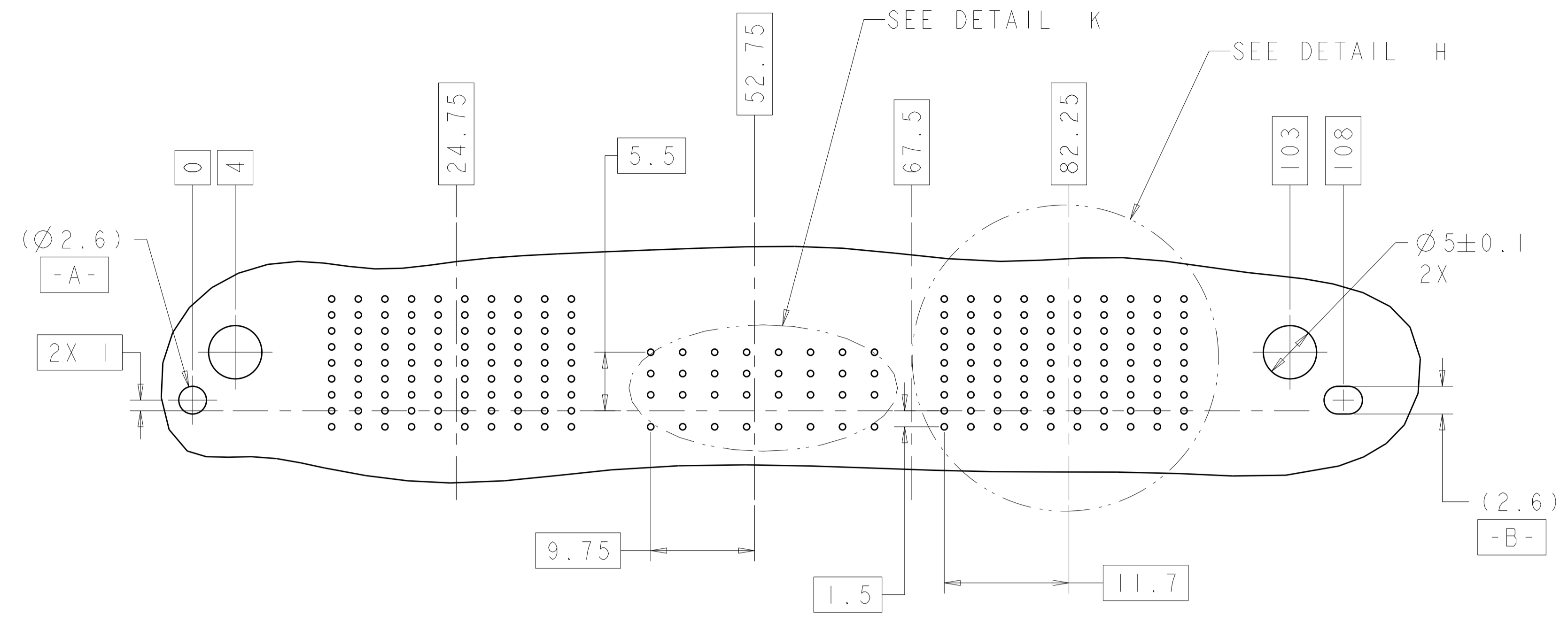

RECOMMENDED PC BOARD HOLE LAYOUT
AS VIEWED FROM TOP OF PCB
PCB FOR 2000980-4 SHOWN
(2 HM-Zd AND 1 UPM MODULE)
SCALE 3:1

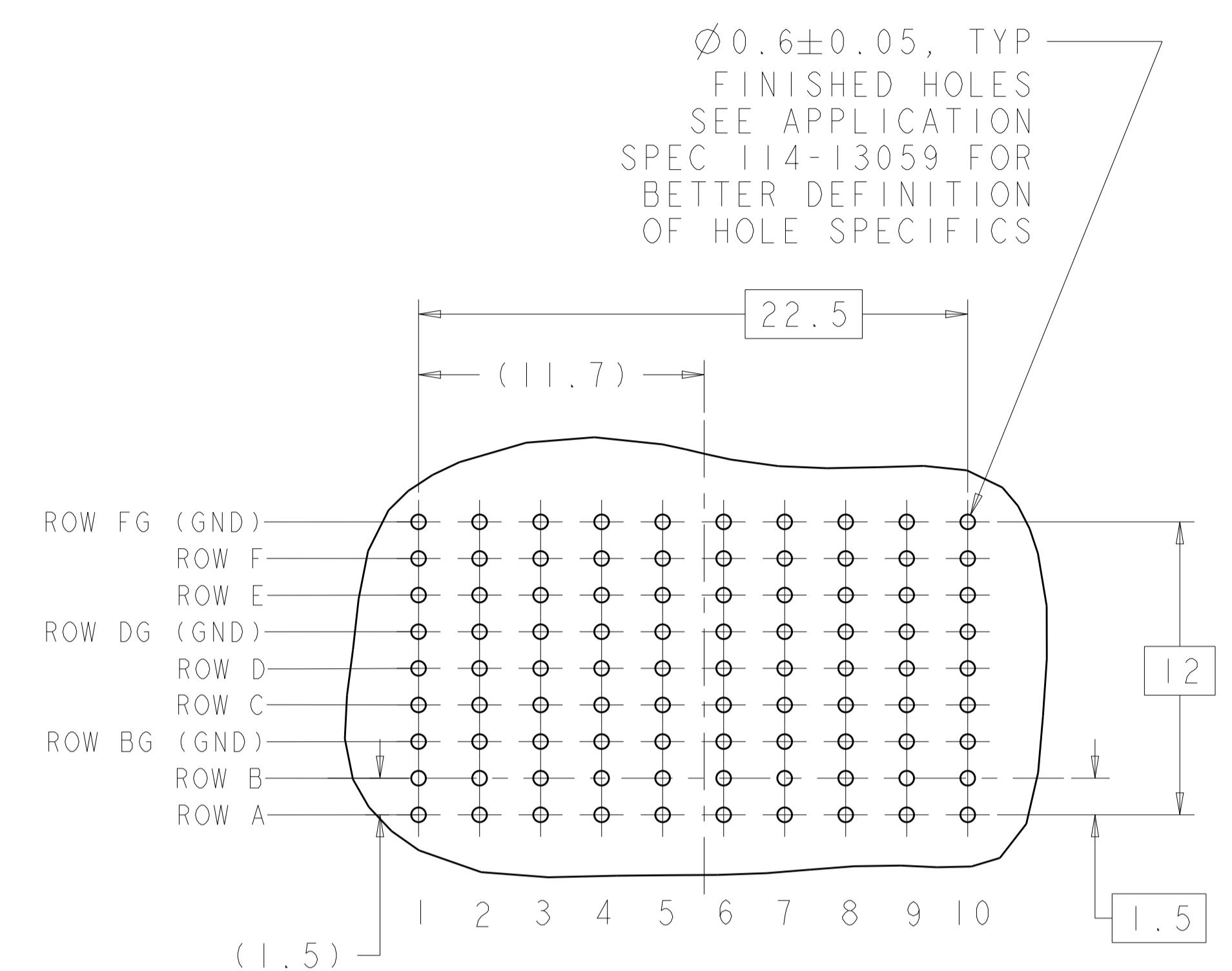

3 PAIR HMZd
TYP 2X FOR -4
TYP 3X FOR -5
DETAIL H
SCALE 5:1

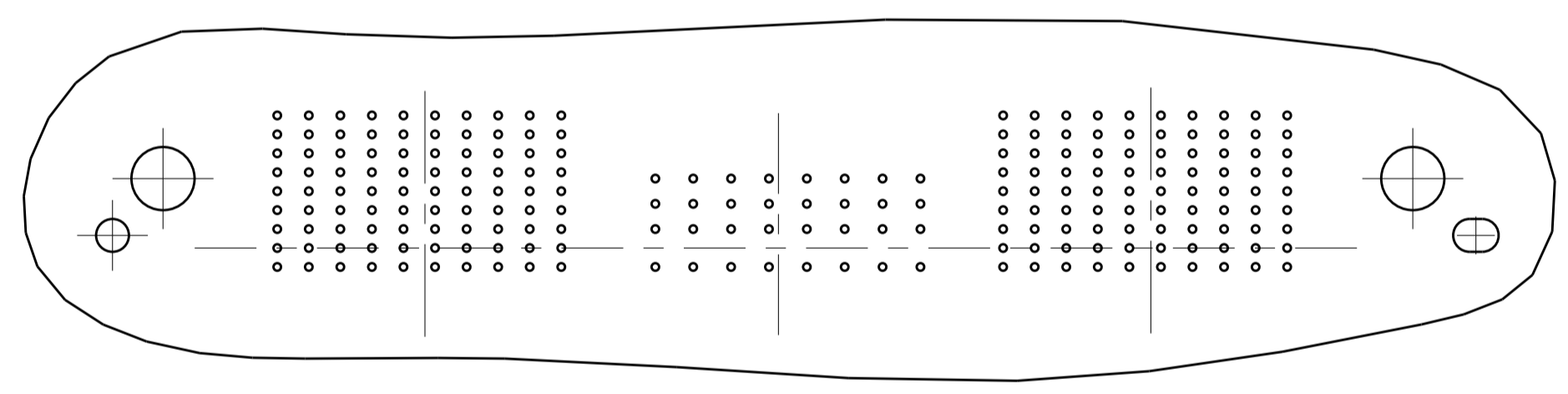

POCKET C POCKET B POCKET A
2000980-4 PCB
SCALE 2:1

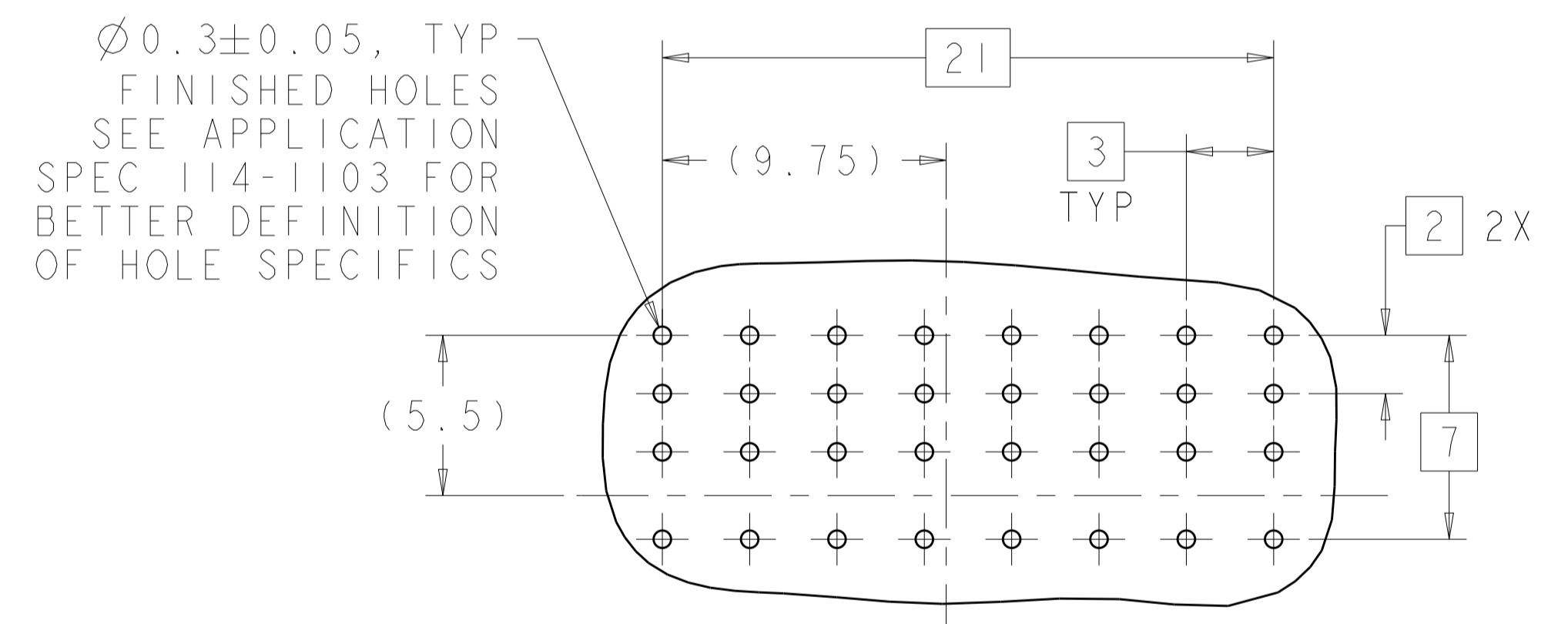

H G F E D C B A
8 POSITION
UNIVERSAL POWER MODULE
DETAIL K
SCALE 5:1

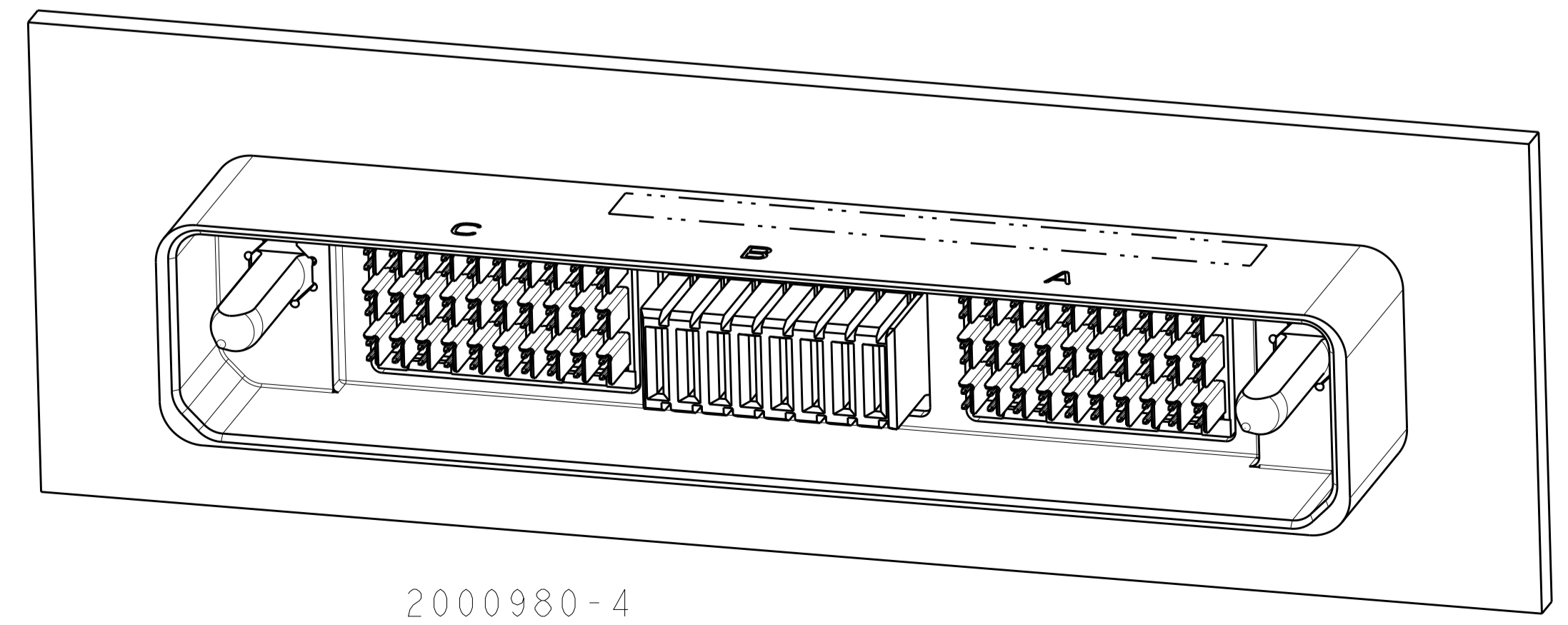

2000980-4
SCALE 2:1

THIS DRAWING IS A CONTROLLED DOCUMENT.		OWN: Brent D. Toth	13JAN2010	TE Connectivity
DIMENSIONS: mm		CHK: CHONG YI	13JAN2010	
TOLERANCES UNLESS OTHERWISE SPECIFIED:		APVD: M. R. McALONIS	13JAN2010	NAME: MOTHER BOARD CONNECTOR, HIGH SPEED RUGGEDIZED (HSR), 3 BAY, UNSEALED, VERTICAL PRODUCT SPEC: 108-2381 APPLICATION SPEC:
0 PLC ±0.2 1 PLC ±0.1 2 PLC ±0.05 3 PLC ±0.025 4 PLC ±0.1		SIZE: A1	CAGE CODE: 00779	
MATERIAL: SEE TABLE		FINISH: SEE TABLE	WEIGHT: -	RESTRICTED TO: -
CUSTOMER DRAWING		SCALE: 1:1		SHEET: 2 OF 3

LOC		DIST		REVISIONS			
				DESCRIPTION	DATE	DMN	APVD
-	-	-	-	SEE SHEET 1	-	-	-

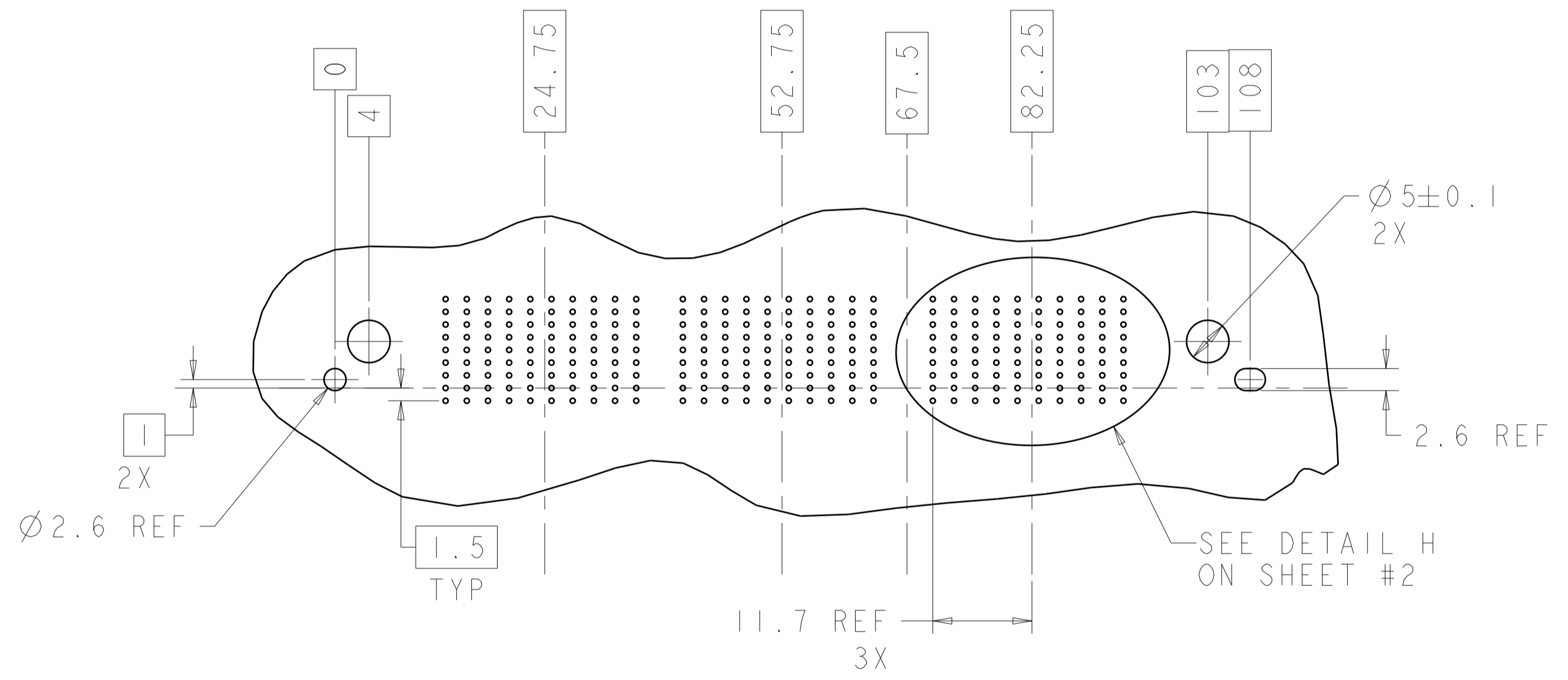

RECOMMENED PC BOARD LAYOUT (MOTHERBOARD)
 FOR 2000980-5
 AS VIEWED FROM TOP OF PCB
 (3 HM-Zd)

THIS DRAWING IS A CONTROLLED DOCUMENT.		DMN Brent D. Tolm	13JAN2010	TE Connectivity
DIMENSIONS: mm		CHK CHONG YI	13JAN2010	
TOLERANCES UNLESS OTHERWISE SPECIFIED: 0 PLC ±0.2 1 PLC ±0.1 2 PLC ±0.05 3 PLC ±0.025 4 PLC ± ANGLES ±°		APVD M. R. McALONIS	13JAN2010	NAME MOTHER BOARD CONNECTOR, HIGH SPEED RUGGEDIZED (HSR), 3 BAY, UNSEALED, VERTICAL
MATERIAL -		FINISH SEE TABLE	WEIGHT -	RESTRICTED TO -
CUSTOMER DRAWING		SCALE 1:1	SHEET 3 OF 3	REV G

单击下面可查看定价，库存，交付和生命周期等信息

[>>TE Connectivity\(泰科\)](#)