



5G/4G/3G/2G, NB-IoT, Cat-M, GNSS, Wi-Fi 6 WORLD BAND ANTENNA

Part Numbers: 2195889-1, 2195889-2

FEATURES & BENEFITS

- Wide Band coverage: LTE, 5G, NB-IoT, Cat-M, GNSS and Wi-Fi 6 Dual Band
- 90 degree hinge type SMA terminal mount
- No matching circuits required
- Similar performance for connection via coax cable and coax connector on PCB

SPECIFICATIONS

| | | | | | | |
|---|--|-----------|-----------|-----------|-----------|-----------|
| Frequency Range (MHz) | 617 - 960 | 1427-1661 | 1710-2700 | 3300-4200 | 4400-5000 | 5150-5925 |
| VSWR | < 2.3:1 | < 3.7:1 | < 2.9:1 | < 2.4:1 | < 2.1:1 | < 2.0:1 |
| Average Efficiency | 47 % | 63 % | 76 % | 74 % | 64 % | 65 % |
| Peak Gain | 1.6 dBi | 2.5 dBi | 3.7 dBi | 1.9 dBi | 2.1 dBi | 4.5 dBi |
| Average Gain | -3.3 dBi | -2.3 dBi | -1.3 dBi | -1.3 dBi | -2.0 dBi | -1.9 dBi |
| Power Handling | 10 Watt cw | | | | | |
| Feed Point Impedance | 50 ohms unbalanced | | | | | |
| Polarization | Linear | | | | | |
| Size | 19.91mm x 135.80 mm (Unfolded) 19.91mm x 115.00 mm (Folded) | | | | | |
| Weight | < 16 g | | | | | |
| Mounting | SMA Male Terminal mount | | | | | |
| Mating Connectors | SMA Female | | | | | |
| Operating Temperature | -40 to +85°C | | | | | |
| Storage Temperature | -40 to +85°C | | | | | |
| Packaging Specification | Bag & Box | | | | | |
| Hazardous Materials | A certificate of conformance is available from the product page on TE website. | | | | | |
| Data measured in free space with hinge at 90 degree bend | | | | | | |

RF DATA

VSWR

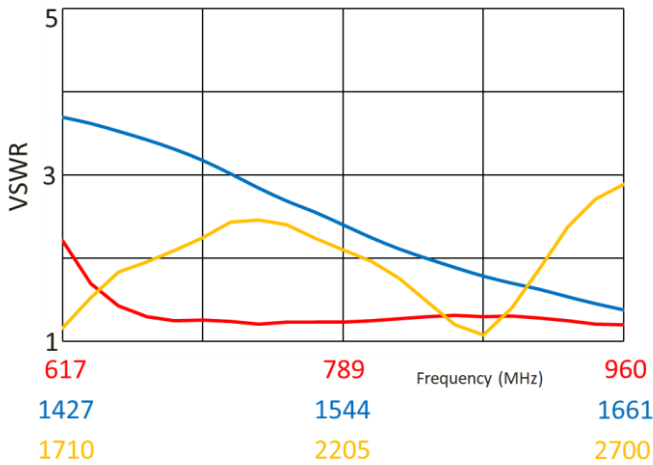

Return Loss

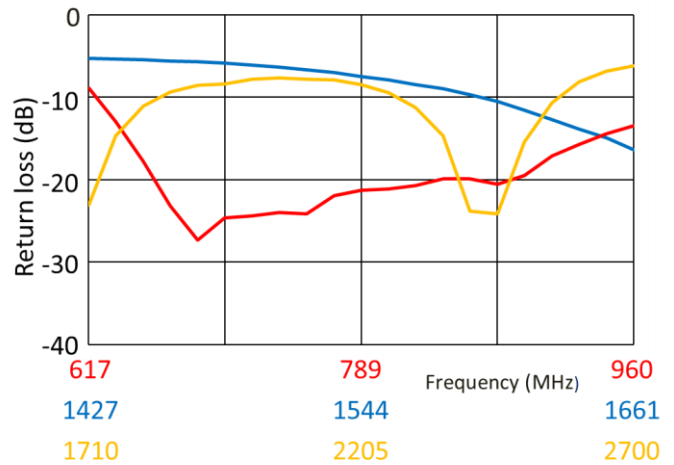

Efficiency

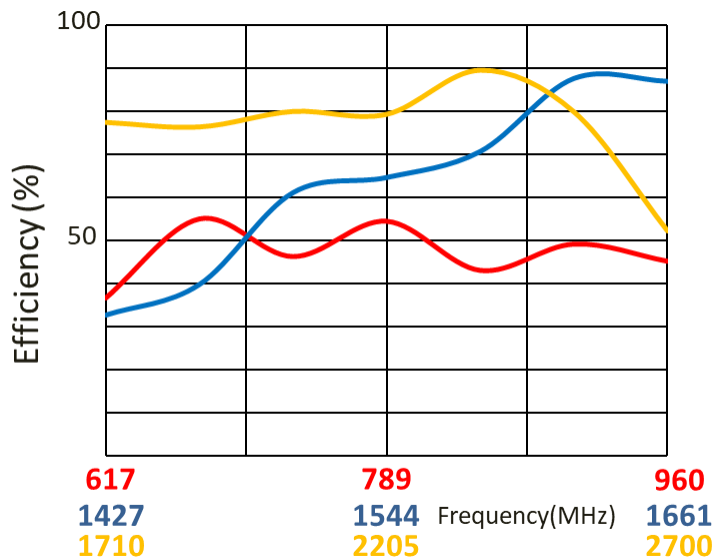

Data measured in free space with hinge at 90 degree bend

RF DATA

VSWR

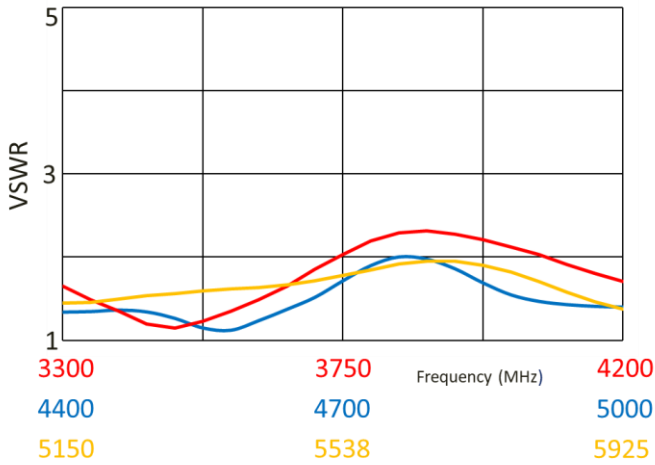

Return Loss

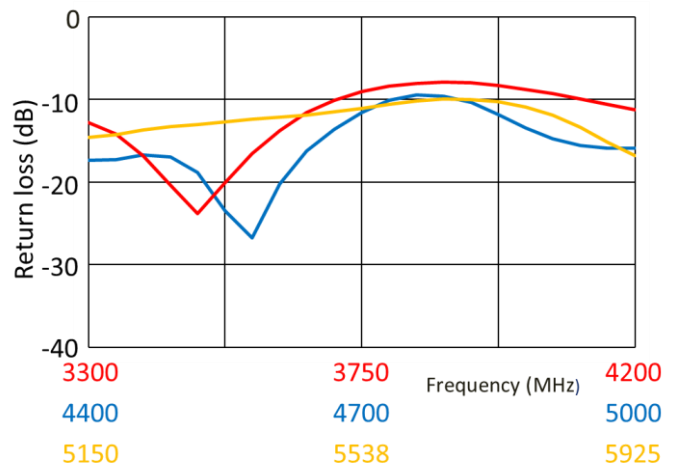

Efficiency

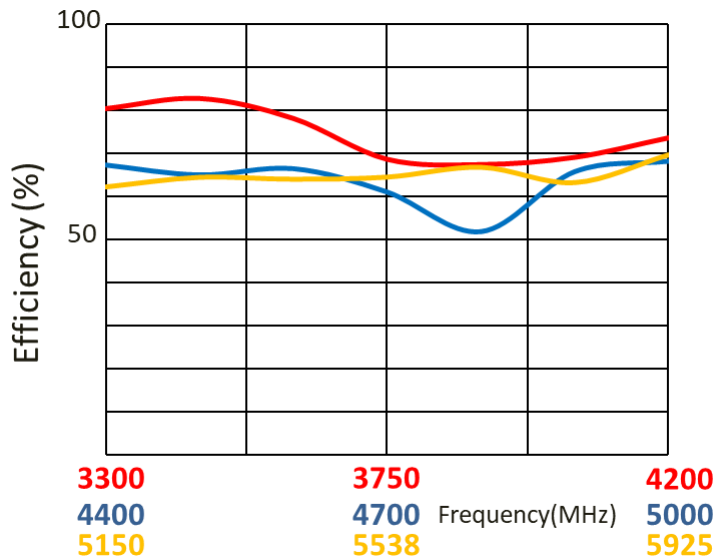

Data measured in free space with hinge at 90 degree bend

RADIATION PATTERN

Test setup

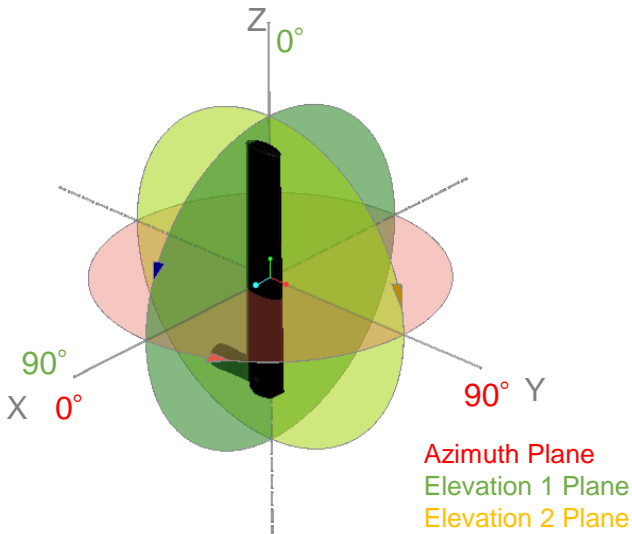

Azimuth

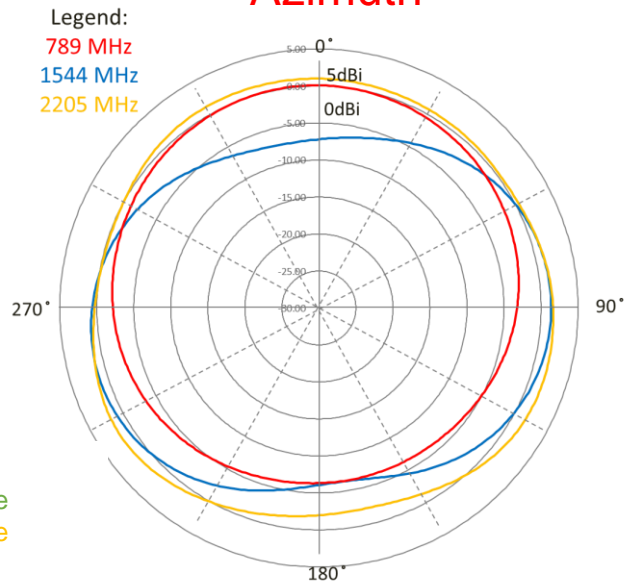

Elevation 1

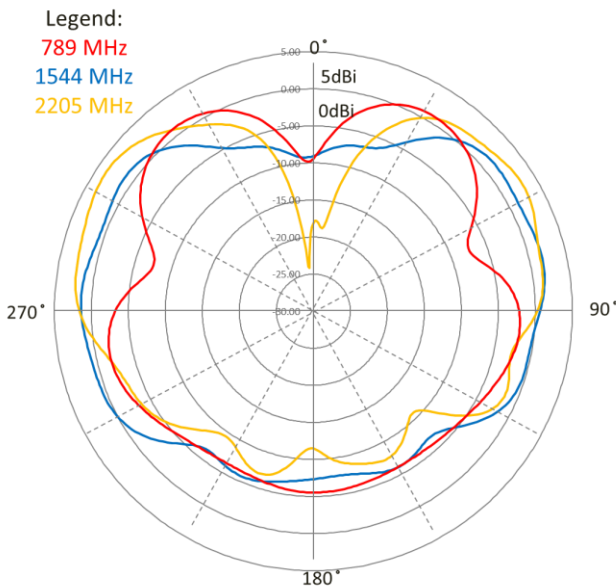

Elevation 2

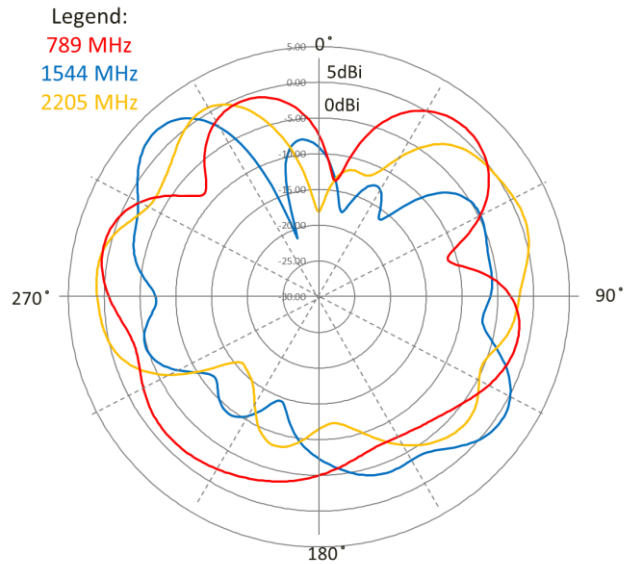

Data measured in free space with hinge at 90 degree bend

RADIATION PATTERN

Test setup

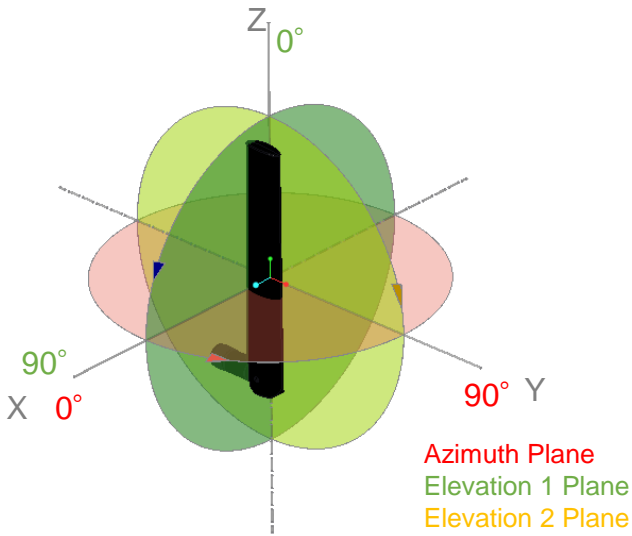

Azimuth

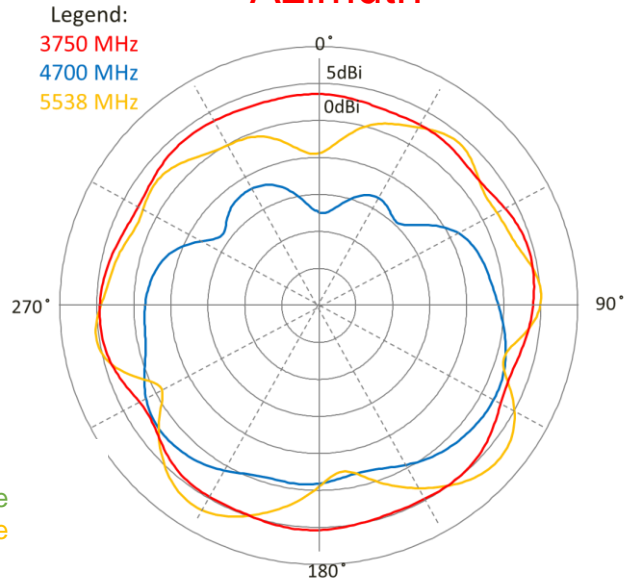

Elevation 1

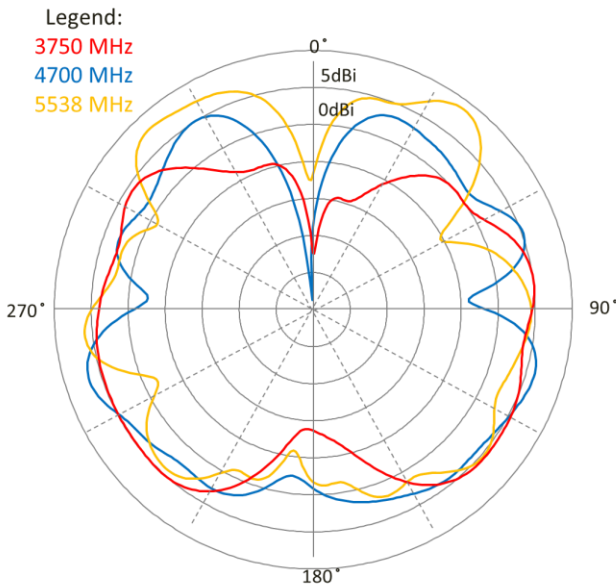

Elevation 2

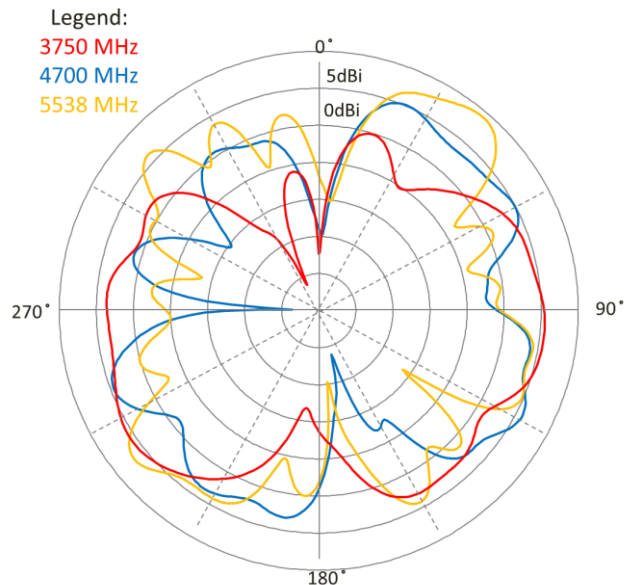



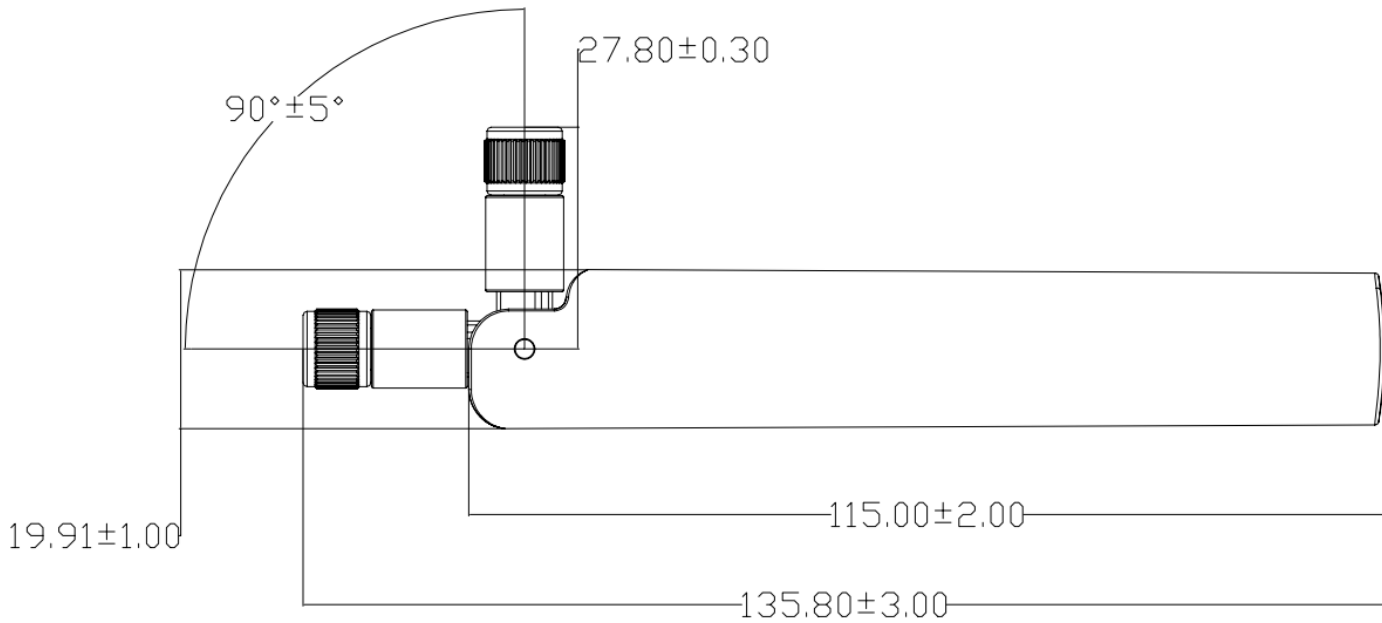

Data measured in free space with hinge at 90 degree bend

DIMENSIONS



MATING COMPONENTS

| | | | | |
|-------------------|-------|-----------------|---|---|
| 2195889-2 | WHITE | SMA (Male) | 5-1814400-2: SMA JACK, RIGHT ANGLE  | 2016682-2: SMA GEN1 (MHF type), 1.13 cable, Length=100mm 2016682-4: SMA GEN1 (MHF type), 1.13 cable, Length=200mm  |
| 2195889-1 | BLACK | SMA (Male) | 5-1814832-2: SMA JACK, VERTICAL  | 2016694-2: SMA GEN4 (MHF4 type), 1.13 cable, Length=100mm 2016694-4: SMA GEN4 (MHF4 type), 1.13 cable, Length=200mm  |
| PART NUMBER | COLOR | CONNECT OR TYPE | RF CONNECTOR | SMA JACK TO MICRO COAX CABLE ASSEMBLIES |
| MATING COMPONENTS | | | | |

PACKAGING

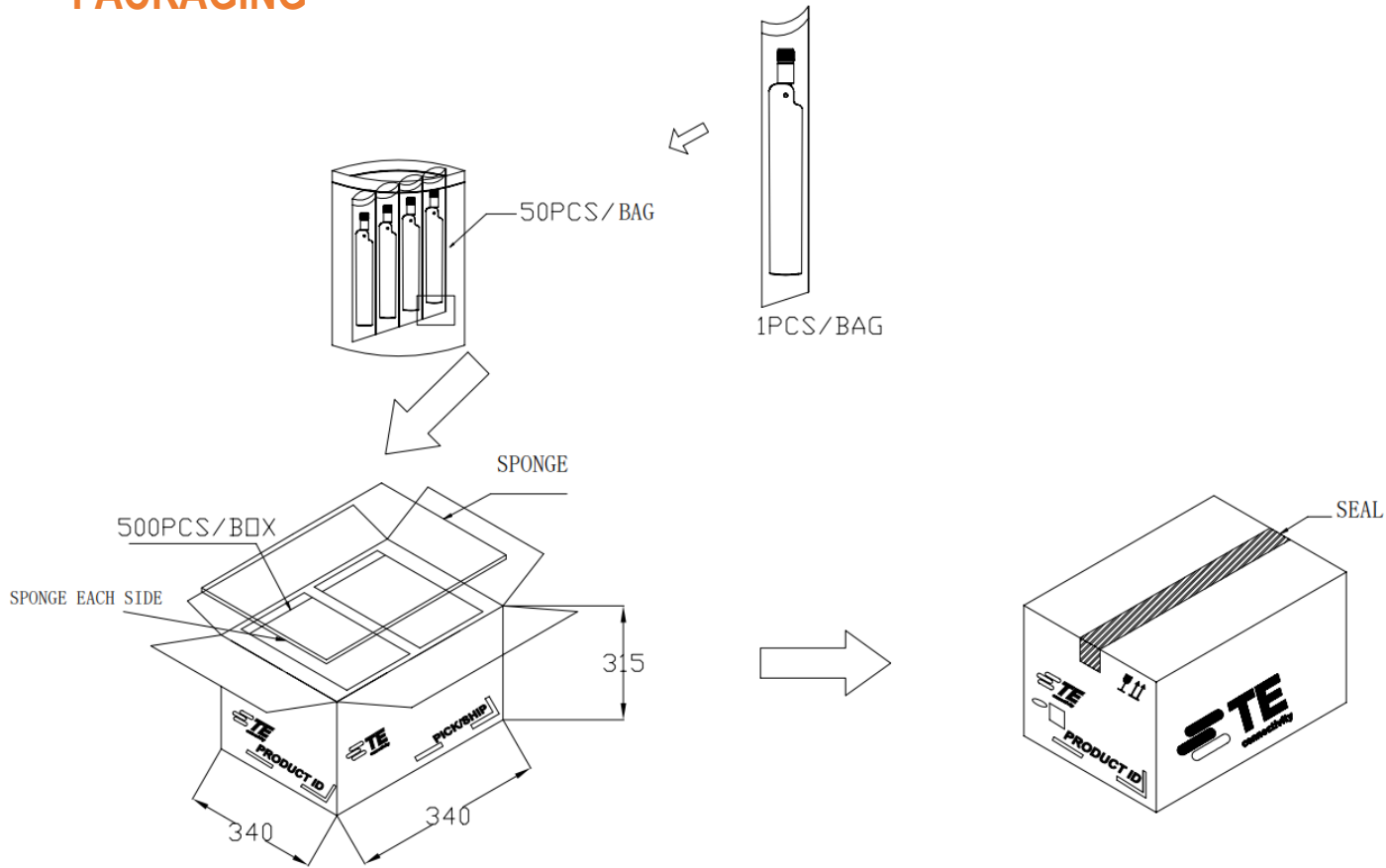

TE TECHNICAL SUPPORT CENTER

- USA: +1 (800) 522-6752
- Canada: +1 (905) 475-6222
- Mexico: +52 (0) 55-1106-0800
- Latin/S. America: +54 (0) 11-4733-2200
- Germany: +49 (0) 6251-133-1999
- UK: +44 (0) 800-267666
- France: +33 (0) 1-3420-8686
- Netherlands: +31 (0) 73-6246-999
- China: +86 (0) 400-820-6015

For phone numbers in other countries, go to te.com/support-center

te.com

TE Connectivity, TE Connectivity (logo) are trademarks. All other logos, products and/or company names referred to herein might be trademarks of their respective owners.

The information given herein, including drawings, illustrations and schematics which are intended for illustration purposes only, is believed to be reliable. However, TE Connectivity makes no warranties as to its accuracy or completeness and disclaims any liability in connection with its use. TE Connectivity's obligations shall only be as set forth in TE Connectivity's Standard Terms and Conditions of Sale for this product and in no case will TE Connectivity be liable for any incidental, indirect or consequential damages arising out of the sale, resale, use or misuse of the product. Users of TE Connectivity products should make their own evaluation to determine the suitability of each such product for the specific application.

© 2020 TE Connectivity Ltd. family of companies All Rights Reserved.

04/2021

单击下面可查看定价，库存，交付和生命周期等信息

[>>TE Connectivity\(泰科\)](#)