

THIS DRAWING IS UNPUBLISHED. RELEASED FOR PUBLICATION XXXX2011  
 © COPYRIGHT 2011 BY Tyco Electronics Japan G.K. ALL RIGHTS RESERVED.

LOC	DIST	REVISIONS					
		P	LTR	DESCRIPTION	DATE	DWN	APVD
J	-		A	REVISED	08NOV2013	Y.O	N.Y
			B	REVISED	12JUN2018	K.T	E.I
			D	REVISED	31JUL2019	K.T	E.I

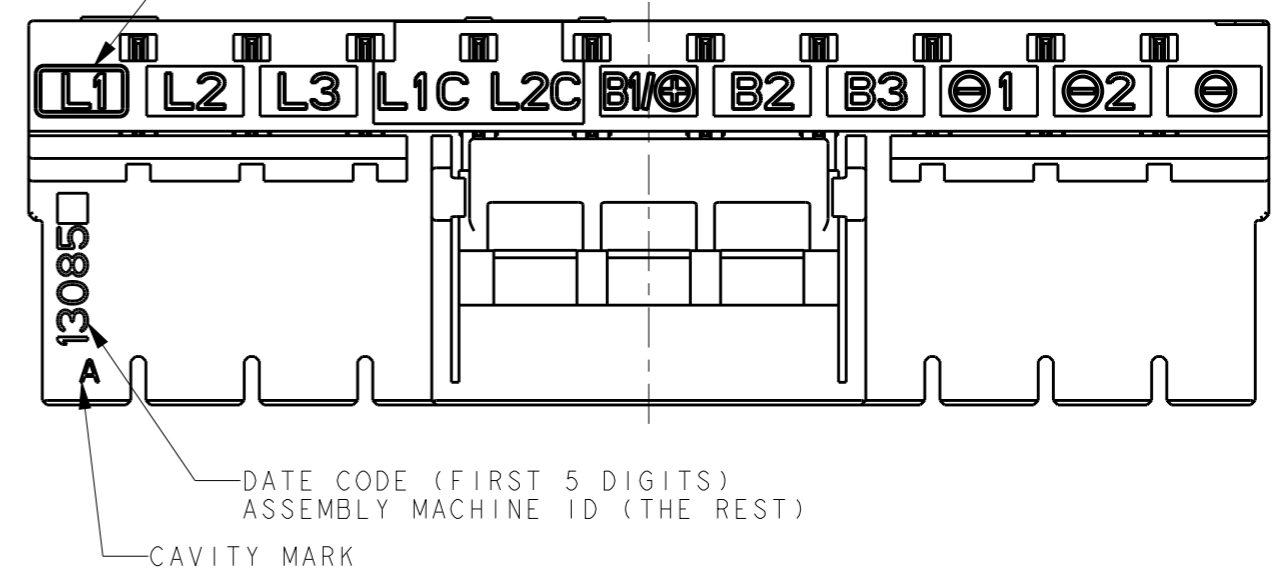
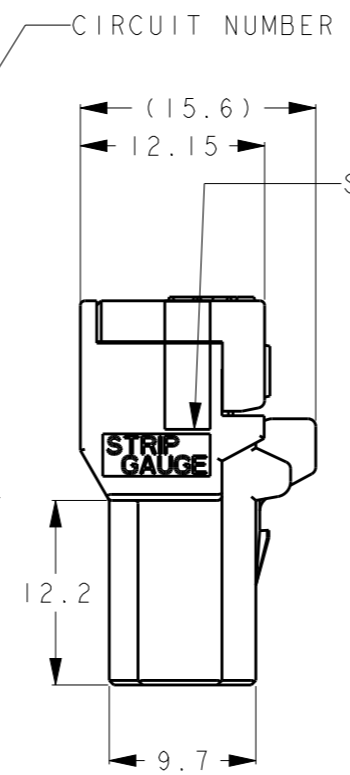
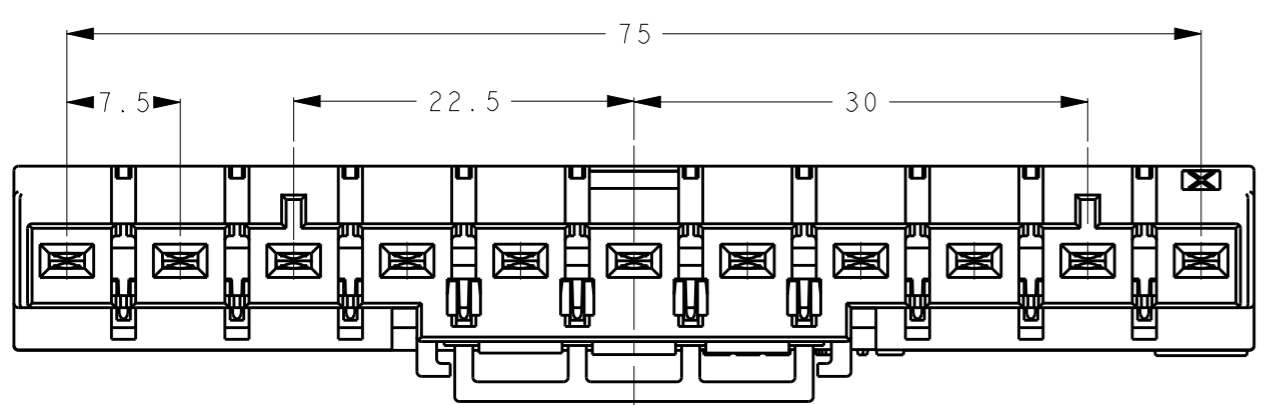
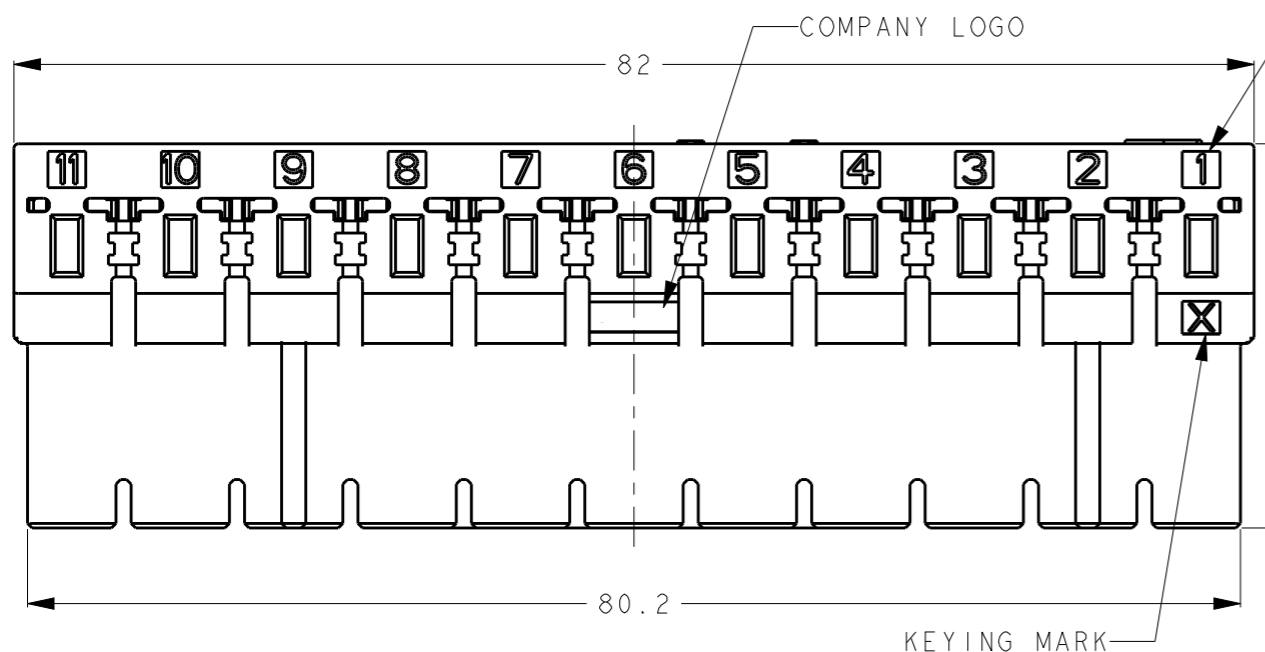
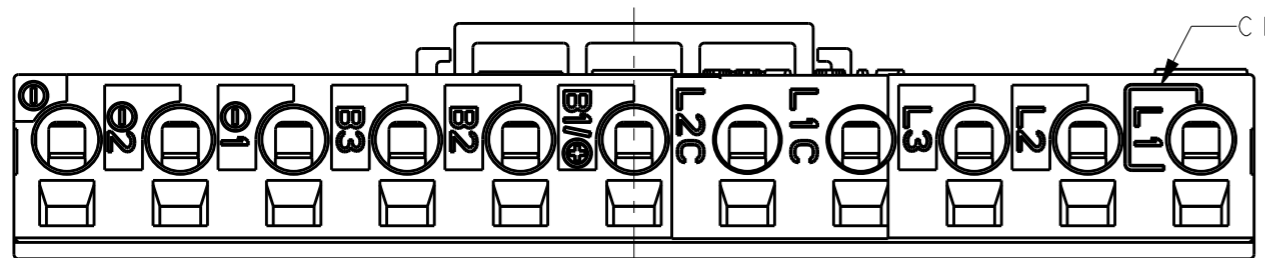

- 1 MATERIAL  
 HOUSING: THERMO PLASTICS  
 CONTACT: COPPER ALLOY  
 SPRING: STAINLESS
- 2 PLATING  
 CONTACT POINT: UNDER Ni PLATING, OVER Au PLATING.  
 WIRE CLAMPING POINT: UNDER Ni PLATING, OVER Tin PLATING.

- 1 材料  
 ハウジング: 熱可塑性ポリエステル  
 コンタクト(内部): 銅合金  
 スプリング(内部): ステンレス
- 2 めっき  
 コンタクト接点部: ニッケル下地めっき上に金めっき  
 コンタクト電線クランプ部: ニッケル下地めっき上に錫めっき

	Y	7	1-2229794-2
	X	11	1-2229794-1
OBSOLETE	X	3	8-2229794-1
	X	3	3-2229794-1
	キーイング KEYING	極数 POS	型番 PART NUMBER

1-2229794-1 (11 POSN KEYING: X) BLACK

THIS DRAWING IS A CONTROLLED DOCUMENT.		DWN Y. OKADA 20FEB2013	TE Connectivity	
DIMENSIONS: 単位: 耗 mm		CHK S. YAMADA 20FEB2013		
TOLERANCES UNLESS OTHERWISE SPECIFIED: 一般公差 ±0.3		APVD N. YAMASAKI 20FEB2013	NAME 名称 DYNAMIC D3950 RECEPTACLE ASSEMBLY	
0 PLC ±		PRODUCT SPEC 製品規格 108-78997	SIZE A300779	
1 PLC ±0.5		APPLICATION SPEC 取付適用規格 411-78272	DRAWING NO 番号 C=2229794	
2 PLC ±0.13		WEIGHT -	RESTRICTED TO -	
3 PLC ±0.013		CUSTOMER DRAWING	SCALE 尺度 2:1	
4 PLC ±0.000J			SHEET 1 OF 3	
ANGLES ±5		REV D		
MATERIAL 材料	SEE NOTE	FINISH 仕上	SEE NOTE	

4

3

2

1

THIS DRAWING IS UNPUBLISHED.

RELEASED FOR PUBLICATION

XXXX2011

© COPYRIGHT 2011

BY Tyco Electronics Japan G.K.

ALL RIGHTS RESERVED.

LOC	DIST	REVISIONS					
		P	LTR	DESCRIPTION	DATE	DWN	APVD
J	-			SEE SHEET 1			

—コンタクト無し  
NO CONTACT

1-2229794-2 (7POSN KEYING:Y) BLACK

THIS DRAWING IS A CONTROLLED DOCUMENT.		DWN Y. OKADA 20FEB2013	TE Connectivity	
DIMENSIONS: 単位: 丸 mm		CHK S. YAMADA 20FEB2013		
TOLERANCES UNLESS OTHERWISE SPECIFIED: 一般公差 ±0.3		APVD N. YAMASAKI 20FEB2013	NAME 名称 DYNAMIC D3950 RECEPTACLE ASSEMBLY	
		PRODUCT SPEC 製品規格 108-78997	SIZE A300779	
MATERIAL 材料 SEE NOTE		APPLICATION SPEC 取付適用規格 411-78272	DRAWING NO 番号 C-2229794	
FINISH 仕上 SEE NOTE		WEIGHT -	RESTRICTED TO -	
CUSTOMER DRAWING		SCALE 尺度 1:1	SHEET 2 OF 3 REV D	

1470-19 (3/11)

Downloaded From [Oneyac.com](http://Oneyac.com)

THIS DRAWING IS UNPUBLISHED. RELEASED FOR PUBLICATION XXXXX2011  
 © COPYRIGHT 2011 BY Tyco Electronics Japan G.K. ALL RIGHTS RESERVED.

LOC	DIST	REVISIONS 変更			
P	LTR	DESCRIPTION	DATE	DWN	APVD
		SEE SHEET 1			

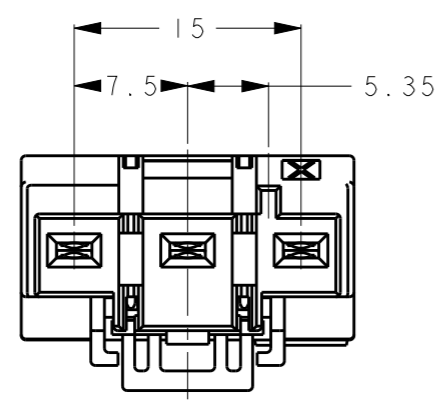
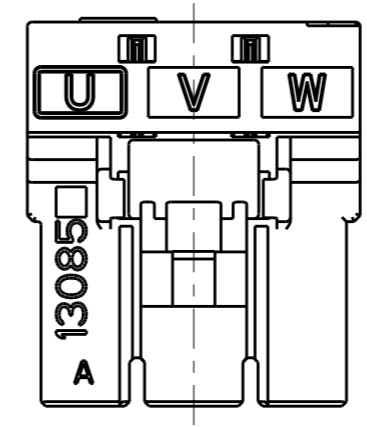
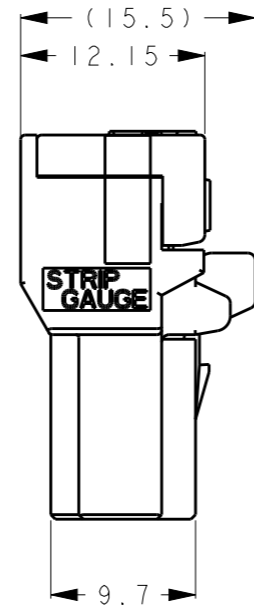
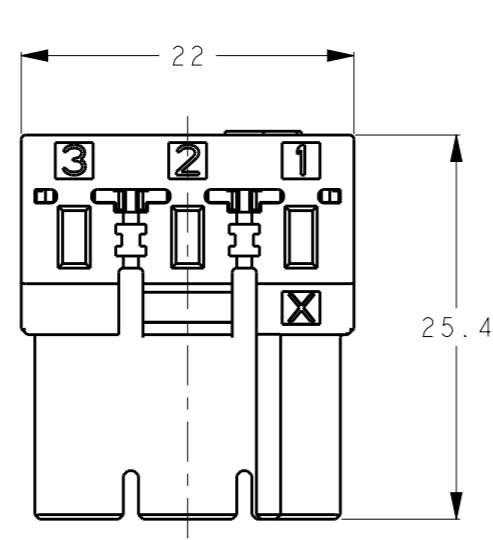
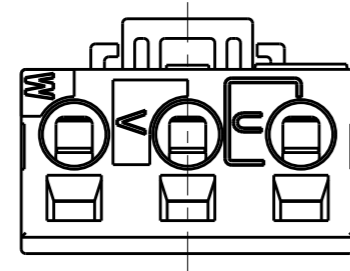

3-2229794-1 (3極 キーイングX) BLACK

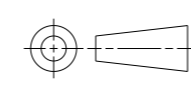
THIS DRAWING IS A CONTROLLED DOCUMENT.		DWN Y. OKADA 20FEB2013	 TE Connectivity		
DIMENSIONS: 単位: 概 mm 		CHK S. YAMADA 20FEB2013			
TOLERANCES UNLESS OTHERWISE SPECIFIED: 一般公差 ±0.3 0-PLC ± 1-PLC ±0.5 2-PLC ±0.13 3-PLC ±0.013 4-PLC ±0.000J ANGLES ±5		APVD N. YAMASAKI 20FEB2013	NAME DYNAMIC D3950 RECEPTACLE ASSEMBLY		
MATERIAL 材料 SEE NOTE		PRODUCT SPEC 製品規格 108-78997	SIZE A3	CAGE CODE 00779	DRAWING NO C-2229794
FINISH 仕上 SEE NOTE		APPLICATION SPEC 取付適用規格 411-78272	RESTRICTED TO -		
		WEIGHT -	SCALE 尺度 2:1		
		CUSTOMER DRAWING		SHEET 3 OF 3	
				REV D	

单击下面可查看定价，库存，交付和生命周期等信息

[>>TE Connectivity\(泰科\)](#)