

| LOC | | DIST | | REVISIONS | | | |
|-----|----|------|---------------------------|-----------|----|-----|------|
| GP | 00 | REV | DESCRIPTION | DATE | BY | CHK | APPV |
| | | N2 | REVISED PER ECO-06-020813 | 25/OCT/06 | ZR | | CR |
| | | N3 | REV PER ECO-09-020932 | 01SEP09 | KK | | AEG |

- △ HOUSING MATERIAL: UL RATED 94V-0 LCP THERMOPLASTIC, COLOR-BLACK.
- COVER MATERIAL: UL RATED 94V-0 POLYESTER MOLDING COMPOUND, COLOR-BLACK.
- △ CONTACT MATERIAL: COPPER ALLOY.
- △ CONTACT FINISH: 0.00254-0.00508 [.00100-.000200] BRIGHT TIN-LEAD OVER 0.00127-0.00254 [.000050-.000100] NICKEL.
- △ POSITION 1 INDICATOR; OMITTED FOR PART NUMBER 2-111595-1.
- △ OBSOLETE.
- △ VOID CORES MAY OR MAY NOT BE PRESENT BETWEEN ANY 2 ROWS OF CONTACTS.
- △ OBSOLETE PARTS: OBSOLETE CIS STREAMLINING PER D.RENAUD/D.SINISI

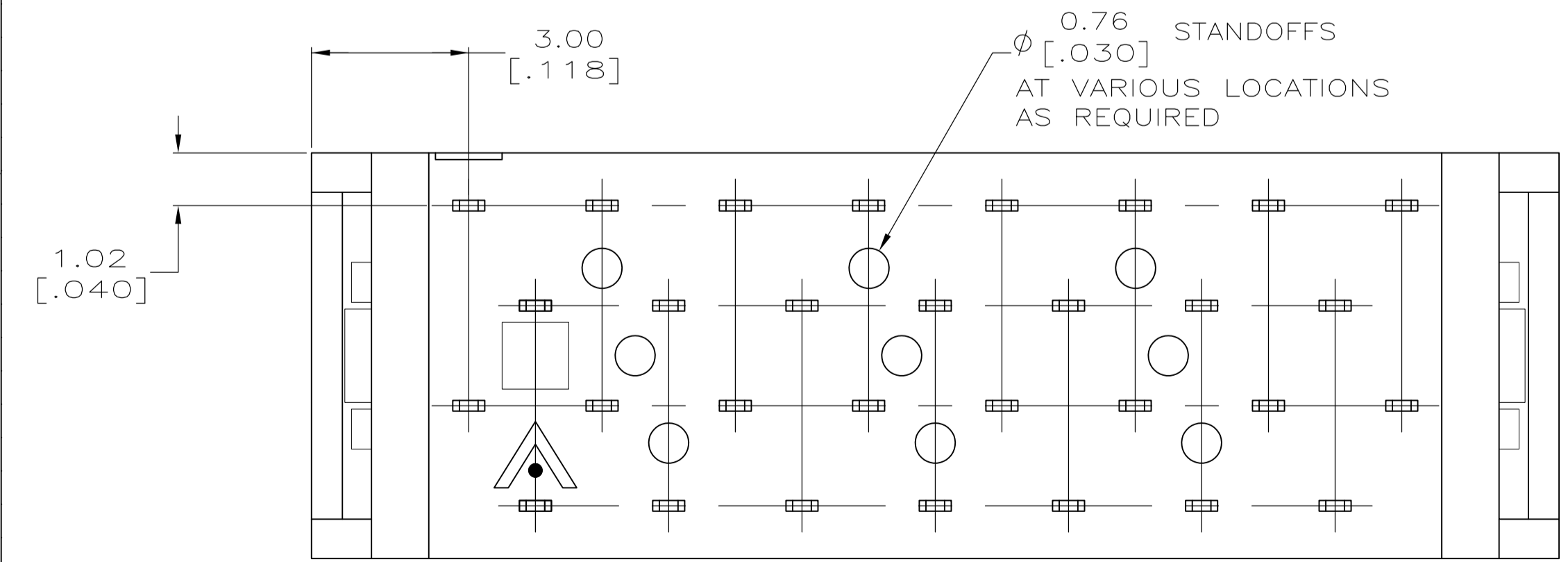
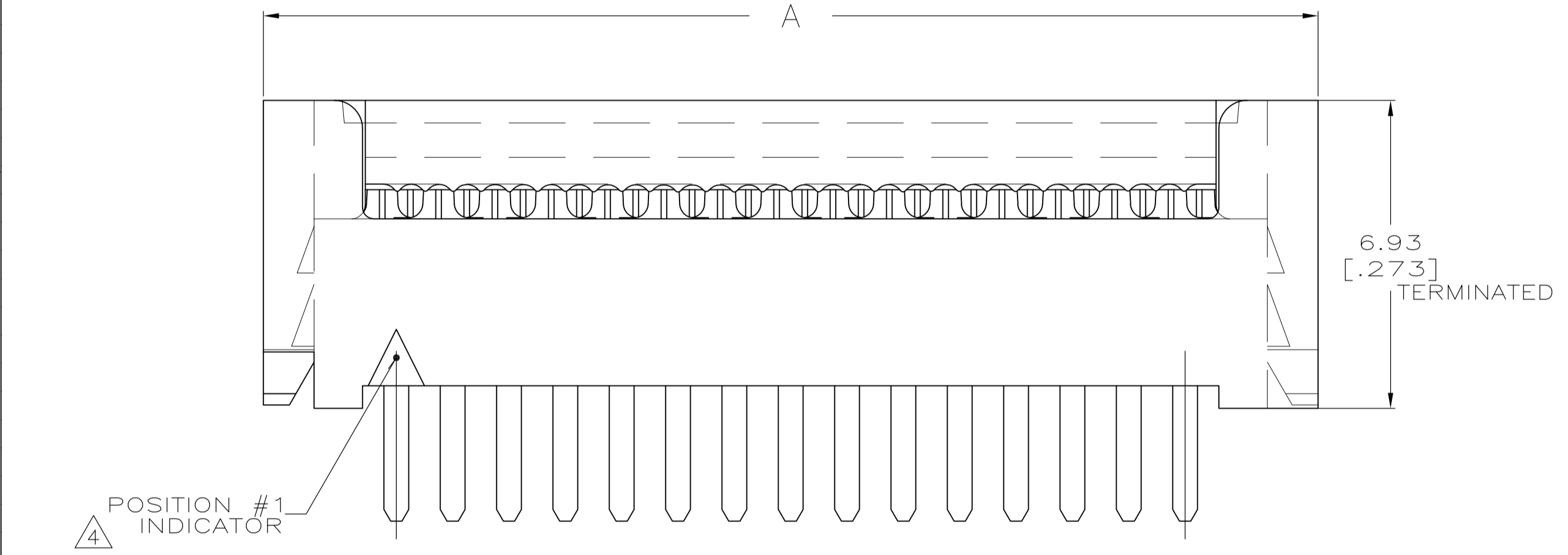
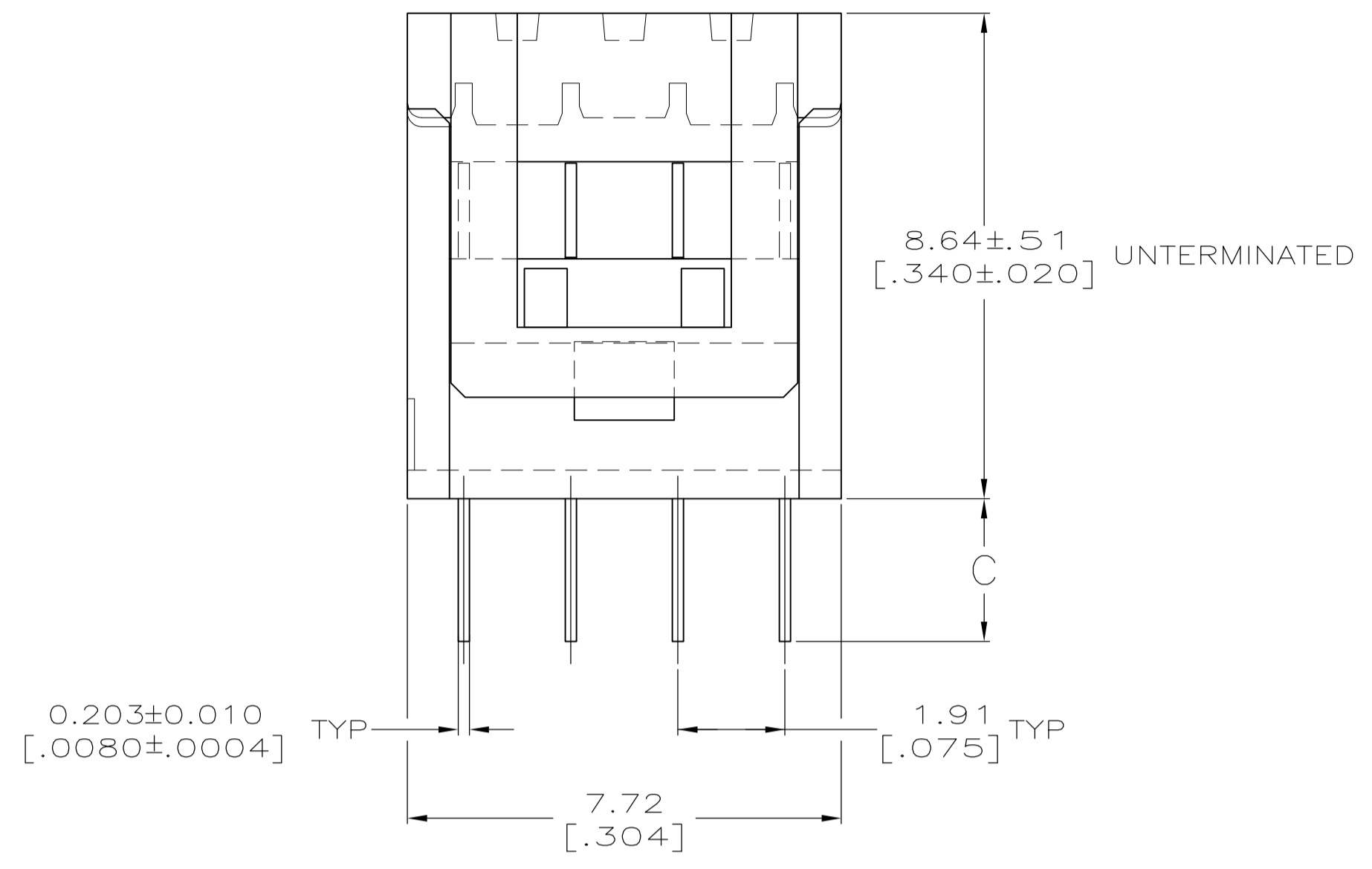
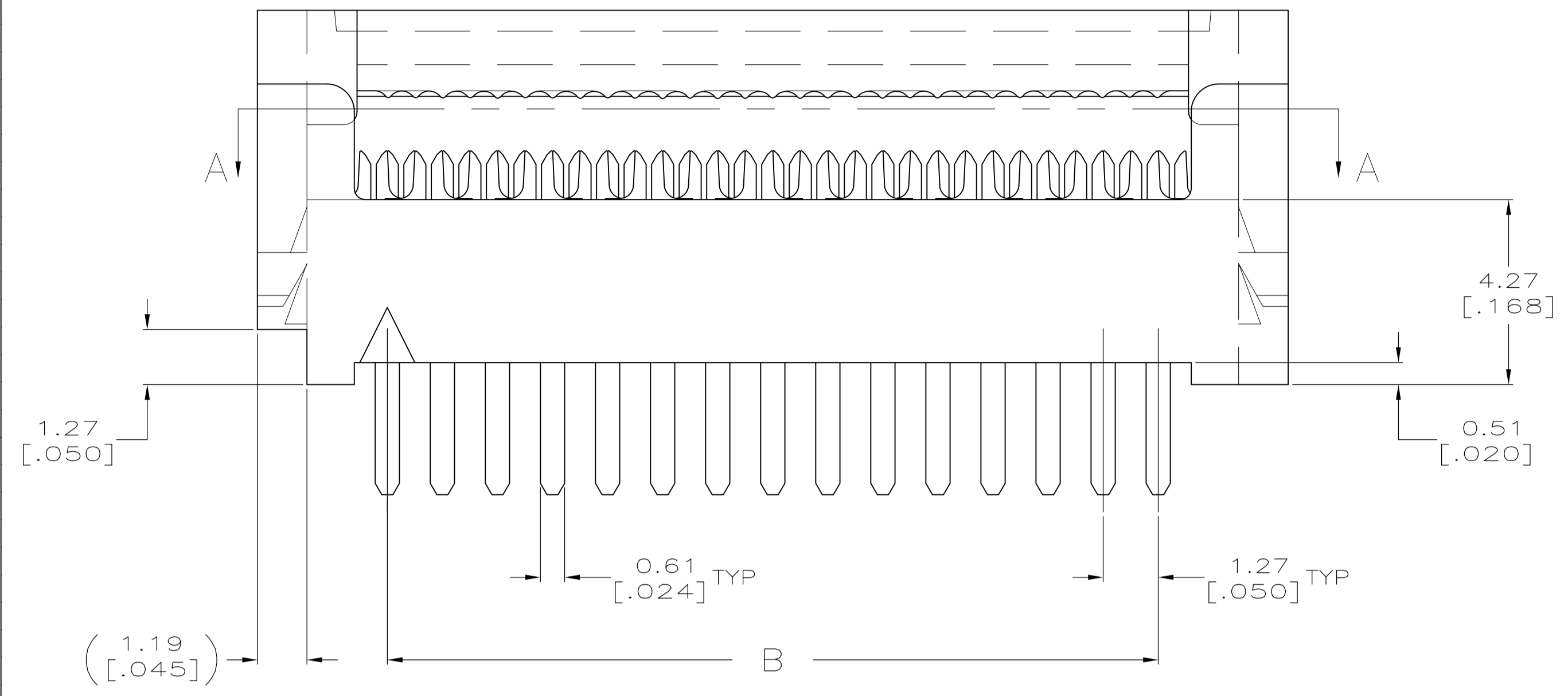

| REV | DESCRIPTION | DATE | BY | CHK | APPV | |
|--------------|-------------|---------------|---------------|---------------|--------------|--------------|
| #2 | 3.30 [.130] | 49.53 [1.950] | 55.52 [2.186] | 80 | △ 2-111595-2 | |
| △ SUPERCEDED | #2 | 2.54 [.100] | 41.91 [1.650] | 47.90 [1.886] | 68 | 2-111595-1 △ |
| △ SUPERCEDED | #2 | 2.54 [.100] | 16.51 [.650] | 22.50 [.886] | 28 | 2-111595-0 |
| | #2 | 2.54 [.100] | 41.91 [1.650] | 47.90 [1.886] | 68 | △ 1-111595-9 |
| | - | 1.91 [.075] | 36.83 [1.450] | 42.82 [1.686] | 60 | △ 1-111595-8 |
| △ SUPERCEDED | #1 | 2.54 [.100] | 27.94 [1.100] | 33.93 [1.336] | 46 | 1-111595-7 |
| | #2 | 2.54 [.100] | 62.23 [2.450] | 68.22 [2.686] | 100 | 1-111595-6 |
| | #2 | 2.54 [.100] | 49.53 [1.950] | 55.52 [2.186] | 80 | △ 1-111595-5 |
| △ SUPERCEDED | #2 | 2.54 [.100] | 44.45 [1.750] | 50.44 [1.986] | 72 | 1-111595-4 |
| △ SUPERCEDED | #2 | 2.54 [.100] | 39.37 [1.550] | 45.36 [1.786] | 64 | 1-111595-3 |
| | #2 | 2.54 [.100] | 36.83 [1.450] | 42.82 [1.686] | 60 | △ 1-111595-2 |
| | #1 | 2.54 [.100] | 30.48 [1.200] | 36.47 [1.436] | 50 | 1-111595-1 |
| △ SUPERCEDED | #2 | 2.54 [.100] | 26.67 [1.050] | 32.66 [1.286] | 44 | 1-111595-0 |
| | #2 | 2.54 [.100] | 24.13 [.950] | 30.12 [1.186] | 40 | 111595-9 |
| | #1 | 2.54 [.100] | 20.32 [.800] | 26.31 [1.036] | 34 | △ 111595-8 |
| | #1 | 2.54 [.100] | 17.78 [.700] | 23.77 [.936] | 30 | 111595-7 |
| | #1 | 2.54 [.100] | 15.24 [.600] | 21.23 [.836] | 26 | 111595-6 |
| △ SUPERCEDED | #2 | 2.54 [.100] | 13.97 [.550] | 19.96 [.786] | 24 | 111595-5 |
| | #2 | 2.54 [.100] | 11.43 [.450] | 17.42 [.686] | 20 | △ 111595-4 |
| | #2 | 2.54 [.100] | 8.89 [.350] | 14.88 [.586] | 16 | 111595-3 |
| △ SUPERCEDED | #1 | 2.54 [.100] | 7.62 [.300] | 13.61 [.536] | 14 | 111595-2 |
| | #1 | 2.54 [.100] | 5.08 [.200] | 11.07 [.436] | 10 | △ 111595-1 |

THIS DRAWING IS A CONTROLLED DOCUMENT.

| | | | | | | | |
|-------------------------|--|-----------|-----------|---------------------|-----------|-----------|------------|
| DIMENSIONS: mm [INCHES] | TOLERANCES UNLESS OTHERWISE SPECIFIED: | 0 PLC ± - | 1 PLC ± - | 2 PLC ± .13 [0.005] | 3 PLC ± - | 4 PLC ± - | ANGLES ± - |
|-------------------------|--|-----------|-----------|---------------------|-----------|-----------|------------|

MATERIAL: △ △ △ FINISH: △

THIS DRAWING IS A CONTROLLED DOCUMENT. **Tyco Electronics** Tyco Electronics Corporation Harrisburg, PA 17105-3608

APPROVED: M. WALMSLEY 11-26-04 NAME: AMPMODU® SYSTEM 50, CONNECTOR, PADDLEBOARD

PRODUCT SPEC: 108-1109

APPLICATION SPEC: 114-25040

SIZE: A1 CAGE CODE: 00779 DRAWING NO: 111595

WEIGHT: -

CUSTOMER DRAWING SCALE: 10:1 SHEET: 1 OF 2 REV: N3

| LOC | | DIST | | REVISIONS | | | |
|-----|-----|-------------|------|-----------|------|--|--|
| P | LTR | DESCRIPTION | DATE | DN | APVD | | |
| | | SEE SHEET 1 | | | | | |

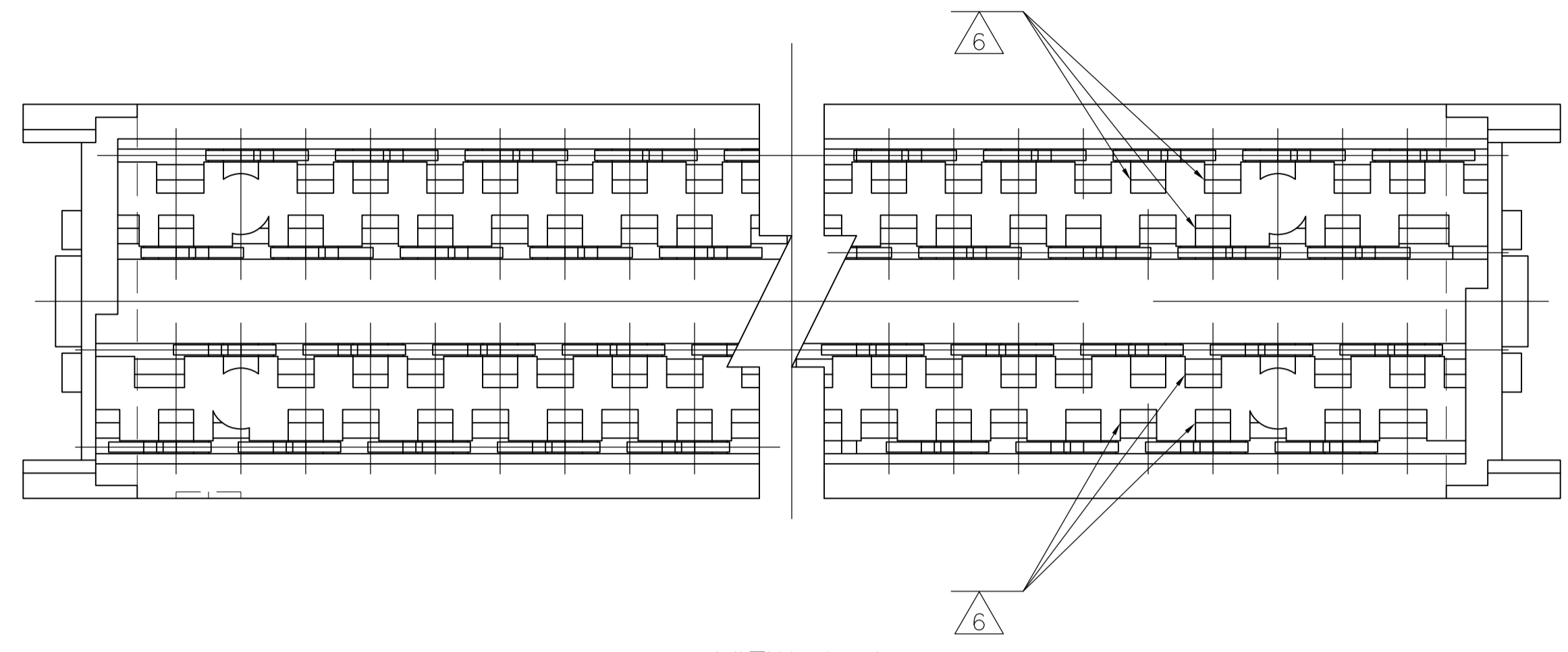

VIEW A-A
(COVER REMOVED FOR CLARITY)

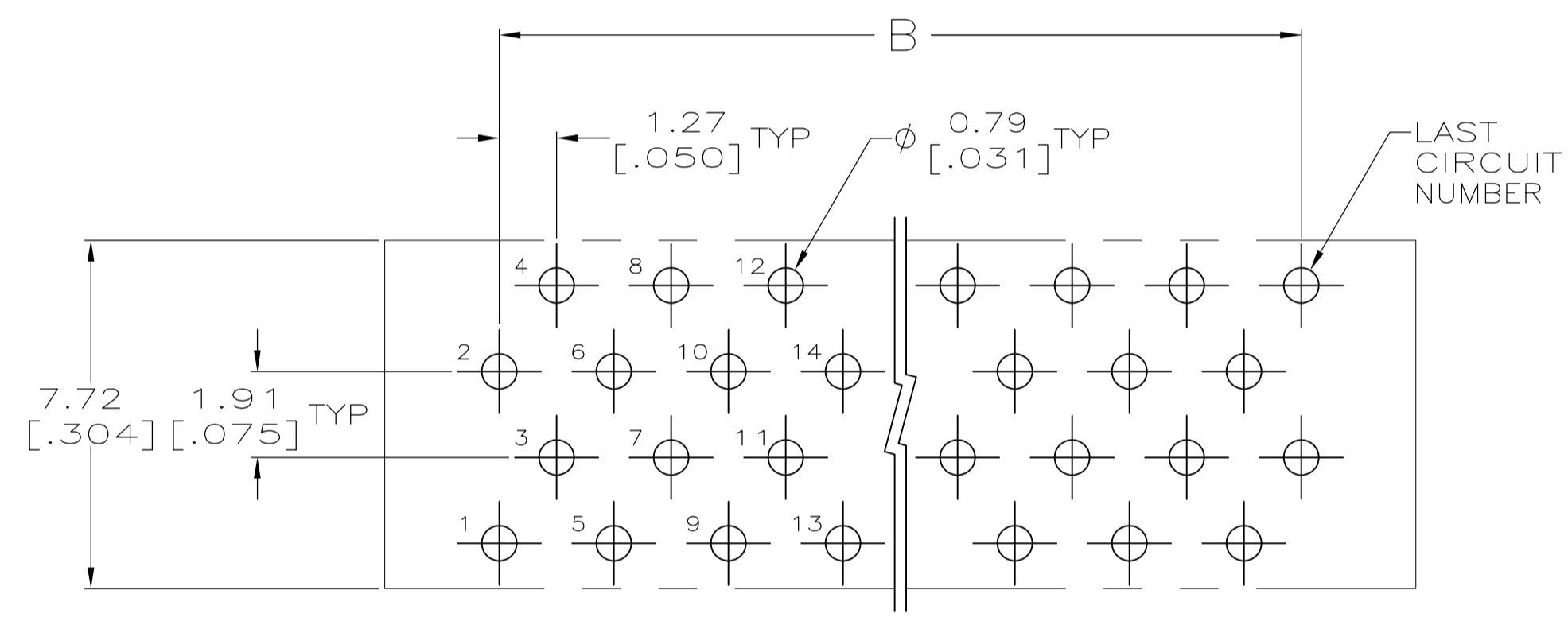

PRINTED CIRCUIT BOARD HOLE LAYOUT #2

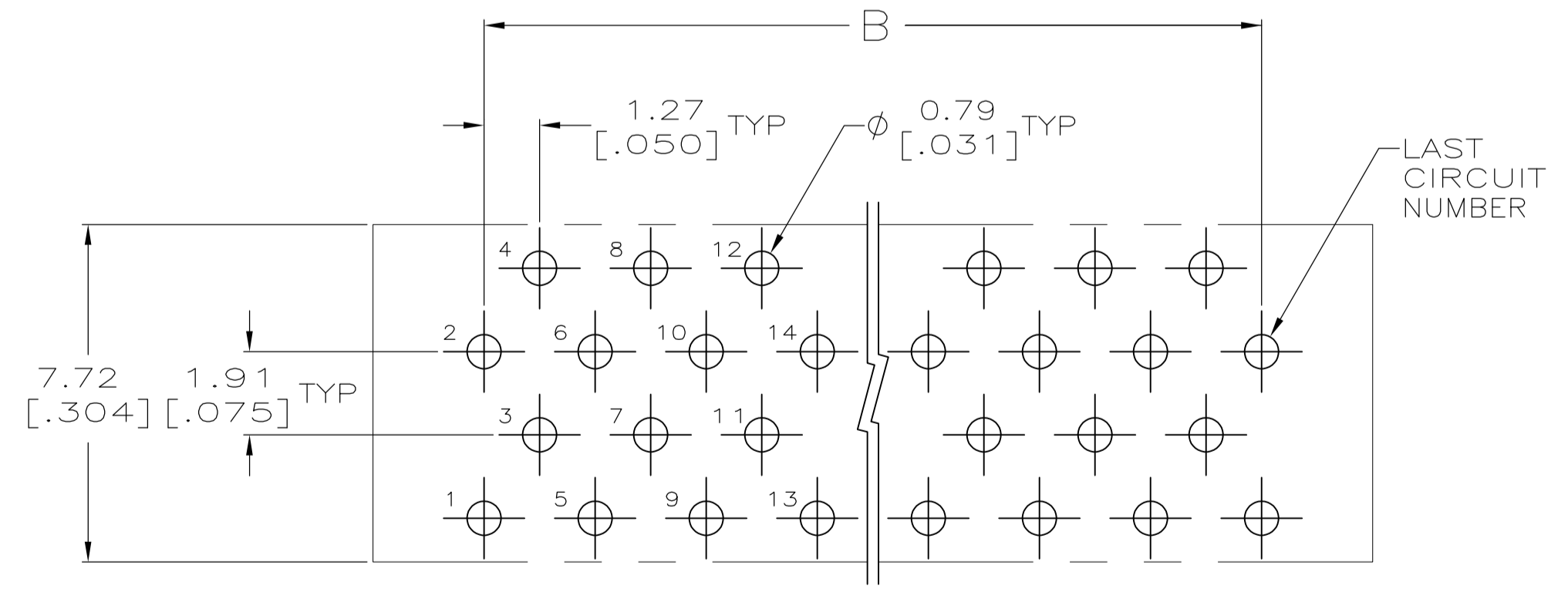

PRINTED CIRCUIT BOARD HOLE LAYOUT #1

| | | | | |
|--|-----------------------|--|---|---------|
| THIS DRAWING IS A CONTROLLED DOCUMENT. | | DIN G. ATTADIA 26NOV04 | Tyco Electronics Corporation Harrisburg, PA 17105-3608 | |
| DIMENSIONS: mm [INCHES] | | CHK C. ROHDE 26NOV04 | APVD M. WALMSLEY 26NOV04 | |
| TOLERANCES UNLESS OTHERWISE SPECIFIED: | | NAME AMPMODU SYSTEM 50, CONNECTOR, PADDLEBOARD | | |
| 0. PLC ± - | | PRODUCT SPEC | | |
| 1. PLC ± - | | APPLICATION SPEC | | |
| 2. PLC ± - | | SIZE A1 | | |
| 3. PLC ± - | | CAGE CODE 00779 | | |
| 4. PLC ± - | | DRAWING NO 111595 | | |
| ANGLES ± - | | RESTRICTED TO | | |
| MATERIAL SEE SHEET 1 | FINISH SEE SHEET 1 | WEIGHT - | CUSTOMER DRAWING | |
| | | SCALE 10:1 | SHEET 2 | OF 2 |
| | | REV N3 | | |

单击下面可查看定价，库存，交付和生命周期等信息

[>>TE Connectivity\(泰科\)](#)