

GENERAL PURPOSE RELAY

TYPE 157



FEATURES:

- The Type 157 relay is a rugged power driver offering superior 3/16" through air and 3/8" over-surface spacing.
- An interlocked frame and contact block prevent contact misalignment during plug-in.
- Open or dust covered available with indicator lamps and push-to-operate buttons.
- A magnetic latching version provides a unique switchable core which cannot be falsely latched.
- All Midtex catalog Type 157 relays have UL & CSA Recognition as motor controllers through 600 VAC
- They provide through air spacing of 3/16" minimum and over-surface spacing of 3/8" minimum and are recognized for 1/2 hp motor controller applications at 240/480/600 VAC (1/3 hp at 120 VAC).
- Chassis mounted open relays must employ 1/32" additional insulation between mounting surface and relay to insure 1/2" over-surface and through air to the mounting surface.
- Sockets for the 157 relays are constructed to meet UL requirements for these ratings.
- UL File E38802 CSA LR54109



TYPE 157

CONTACTS		
Material	UL & CSA Recognition Rating	
-100	1/8" Fine Silver (gold flash) 5 amp	5 amp, 28 VDC/ 120/240 VAC, 80% pf 2 amp 480/600 VAC, 80% pf 1/8 hp 120 VAC 1/4 hp 240 VAC 2 amp 7.2 amp in rush, 24 VAC (SP devices)
-200	3/16" Silver Cadmium Oxide 10 amp	10 amp, 28 VDC/ 120/240 VAC, 80% pf 1/3 hp 120 VAC 1/2 hp 277/240/480/600 VAC 36 LRA, 8.5 FLA, 18VDC 3 amp 480/600 VAC, 80% pf 10 amp 277VAC resistive
-300	3/16" Silver Cadmium Oxide 15 amp (UL on 1 & 2PDT only)	15 amp 277/240/120 VAC 10 amp 28 VDC 3 amp 480/600 VAC 1/3 hp 120 VAC 1/2 hp 240/480/600 VAC 600w Tungsten 120/240 VAC
-700	1/8" Fine Silver Gold Diffused	5 amp, 28 VDC/ 120/240 VAC, 80% pf 2 amp 480/600 VAC, 80% pf 1/8 hp 120 VAC 1/4 hp 240 VAC 2 amp 7.2 amp in rush, 24 VAC (SP devices)
-3MO	Mag Blowout (See Note)	1 Form X 12A @ 150 VDC 2 Form A 7A @ 150 VDC 2 Form C 5A @ 150 VDC

Note: For Mag Blowout positive contacts are 7 and 9. Negative contacts are 1, 3, 4 and 6.

ELECTRICAL/MECHANICAL CHARACTERISTICS

All ratings at 25°C ambient

Design and Construction

Recognized by UL for motor controllers up to 600 VAC in accordance with UL Standard 508, Industrial Control Equipment. Optional features include manual push-to-test button and indicator lamp.

Insulation Material-High quality phenolic

Weight (approximate)-2.3 ounces (64 grams)—open relay
3.0 ounces (84 grams)—enclosed relay

Marking

Midtex name, part number, nominal voltage, and terminal identification are standard. Customer marking optional.

Initial Contact Resistance-50 milliohms max.

COILS						
Voltage Ratings	6 to 240 VAC 50/60 Hz 5 to 110 VDC					
Pick-up Voltage	AC-85% of nominal DC-75% of nominal					
Duty Cycle	Rated for continuous duty operation at 25% overvoltage					
Shock	15 g's, 11±1mS (non-operating test, no mechanical damage)					
Vibration	0.1" DA or 10g's, 10 to 55 Hz (operating test, no contact chatter)					
Power Ratings*						
	1 & 2 Pole AC	3 Pole AC	DC			
Nominal	1.7 VA	2.0 VA	1.2 W			
Max. Continuous	2.7 VA	3.1 VA	1.9 W			
Temperature Rise*						
	1 & 2 Pole AC		3 Pole AC	DC		
	Open	Enc.	Open	Enc.		
Nominal Voltage	35°C	45°C	45°C	60°C	35°C	40°C
25% overvoltage	55°C	65°C	75°C	85°C	50°C	55°C

*60 Hz operation
Increase values 20% for 50 Hz operation.

COIL CHARACTERISTICS

Nominal Voltage	Resistance (Ohms±10%)		
	1 & 2PDT		3PDT
5	20		
6	32		
V	120		
D	470		
C	1800		
110	10000		
6	6.0	4.2	
V	21	18	
A	75	72	
C	2250	1700	
240	9100	7200	

TYPE 157

PART NUMBERING SYSTEM					
Relay Type	Enclosure and Terminals	Contact Arr.	Coil	Contacts	Standard or Special
157	1—Open, Solder/Plug-in/.187 Quick Connect 2—Plain Cover, Solder/Plug-in/.187 Quick Connect 3—Flanged Cover, Solder/.187 Quick Connect 4—Plain Cover with End Mounting Bracket, Solder/Plug-in/.187 Quick Connect 9—Plain Cover, P.C. Terminal 0—Special (Including top flange)	1—SPDT 2—2PDT 3—3PDT 4—1 Form A 5—1 Form B 6—2 Form A 7—2 Form B 8—1 Form X 9—1 Form Y 0—Special	E—5 VDC A—6 VDC B—12 VDC C—24 VDC D—48 VDC F—110 VDC N—6 VAC P—12 VAC Q—24 VAC T—120 VAC U—240 VAC S—Special	1—1/8" Fine Silver Gold Flash 2—3/16" Silver Cadmium Oxide (10 Amp) 3—3/16" Silver Cadmium Oxide (15 Amp) 7—1/8" Fine Silver Gold Diffused 0—Special	00—Standard C0—Push Button Actuator D0—Diode across Coil F0—Class "F" Coil L0—Lamp Across Coil LC—Lamp & Push Button M0—Mag Blowout 09—PC Terminal without Cover. Use 9 in first digit. A1-Z9—Special *Top Flange avail.—Consult Factory

Example: 157-23C200 is a Type 157 relay, plain cover, solder/plug-in/.187 quick connect terminals 3 pole double throw contacts, 24VDC coil, 3/16" diameter Silver Cadmium Oxide contacts, of completely standard construction.

Stock items: 157-22B200, 157-22C200, 157-22C2L0, 157-22F200, 157-22Q200, 157-22Q2LC, 157-22T200, 157-22T2L0, 157-22U200, 157-23B200, 157-23C200, 157-23C2L0, 157-23Q200, 157-23Q2L0, 157-23T200, 157-23T2L0, 157-23T2LC, 157-32B200, 157-32C200, 157-32Q200, 157-32T200, 157-33B200, 157-33C200, 157-33Q200, 157-33T200.

TEMPERATURE RANGE				
Operating**	Minimum	Maximum		Storage
		Open	Enclosed	
1 & 2 pole AC	-45°C	+70°C	+60°C	-65°C to +100°C
3 pole AC	-45°C	+60°C	+45°C	
1, 2, 3, pole DC	-45°C	+80°C	+70°C	

**50/60 Hz operation, based on 105°C limit.

ELECTRICAL CHARACTERISTICS

Dielectric Breakdown

Greater than 1200 VAC, RMS 60 Hz across open contacts
Greater than 2500 VAC, RMS 60 Hz all other mutually insulated elements

Insulation Resistance

1000 megohms minimum at 500 VDC

Timing

Operate time—15 mS nominal, 20 mS maximum
Release time—6 mS nominal, 10 mS maximum
(Nominal voltage, no coils suppression, DC relays only)

Life Expectancy

Mechanical—10 million operations
Electrical—100,000 operations at rated load

DIMENSIONS

Open Model 157-1

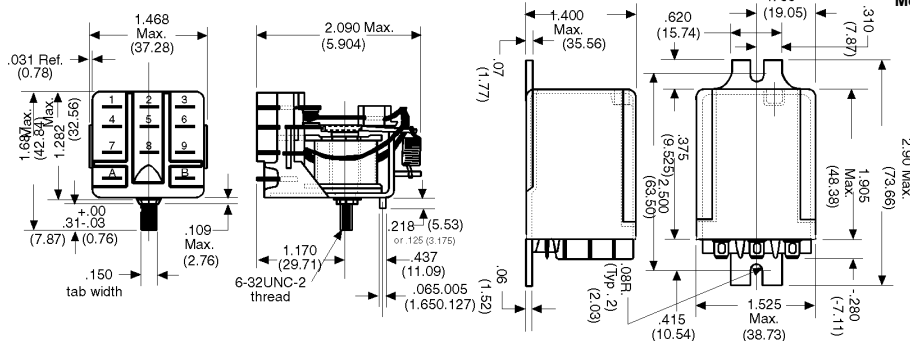

Model 157-3

Dust Cover Model 157-2

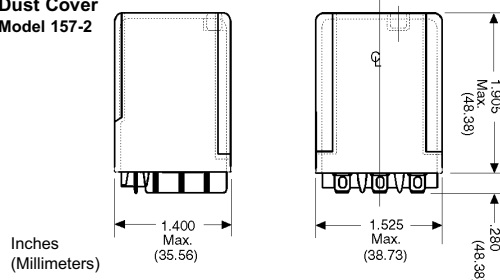

Inches
(Millimeters)

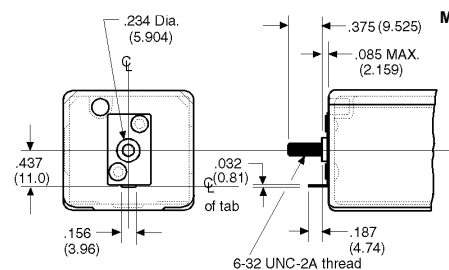

Model 157-4

TYPE 157

TERMINALS

Solder/Plug In .187 Quick Connect

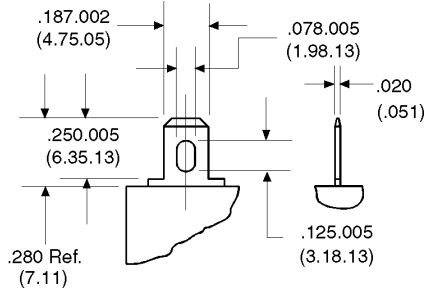

Printed Circuit Terminal

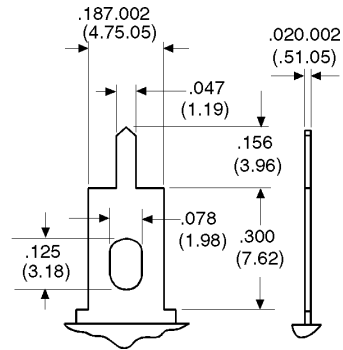

Inches
(Millimeters)

Mates with .187" UL standard quick connect terminal also suitable for solder connection. Model 157-1,-2,-3,-4

Printed Circuit Terminal For direct relay to PCB mounting. Model 157-9

WIRING

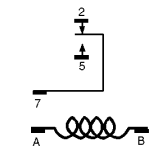

1 Form C (SPDT)

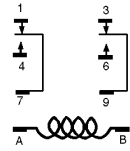

2 Form C (DPDT)

Reference Only

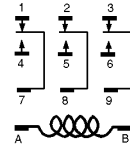

3 Form C (3PDT)

PCB LAYOUT

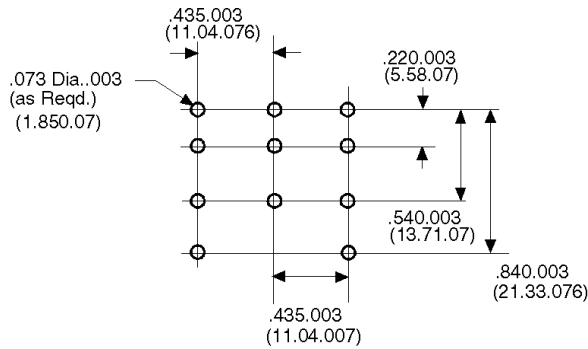

Bottom View
Reference Only

See RELAY SOCKETS on page 51.
See HOLD DOWN SPRINGS on page 53.

单击下面可查看定价，库存，交付和生命周期等信息

[>>TE Connectivity\(泰科\)](#)