

REVISIONS					
P	LTR	DESCRIPTION	DATE	DWN	APVD
P2	ECR-19-008615		03JUN2019	KD	FL

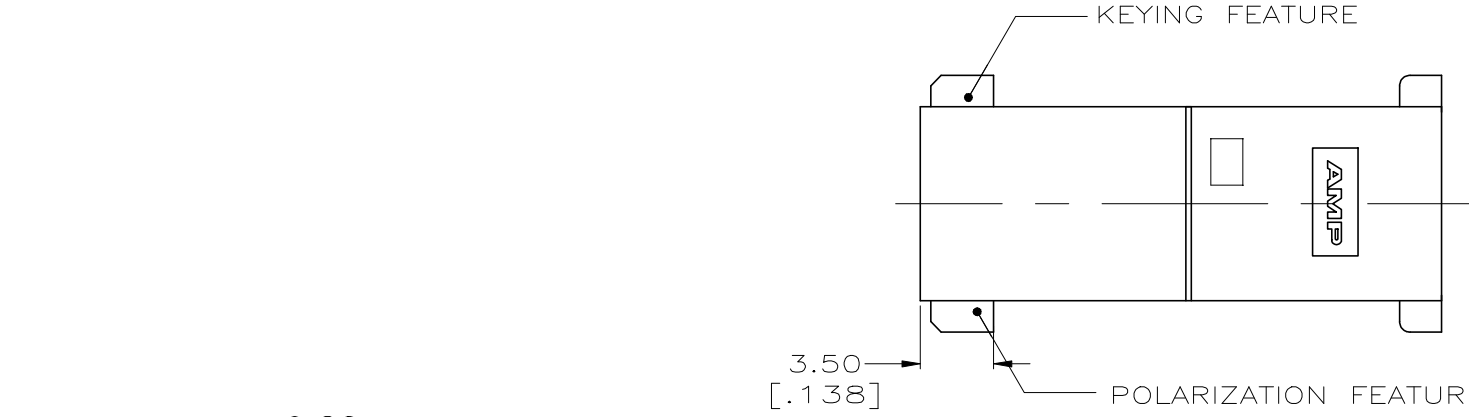

- ACCEPTS RAST P-LOCK CONTACTS. FOR EXAMPLE,
  - 1217378(#18-#22 AWG SINGLE WIRE)
  - 1217094(#18-#14 AWG SINGLE WIRE)
  - 1217095(2x #18'S, 2x #16'S, #16 + #18 COMBINATION).
  - 2238135(#16-#18 AWG SINGLE WIRE, 2x #18)
  - 2238136(#18-#22 AWG SINGLE WIRE)
- FRONT AND BACK VIEWS SHOW ONLY THE GRIPPERS. FOR KEYING AND POLARIZATION FEATURES, SEE SPECIAL FRONT VIEW.
- TAB SHOULDER SLOTS OPTIONAL ON BOTH SIDES OF DUMMY CIRCUIT.

- △4 MATERIAL: UL94 V0, GWPT 750°C NO FLAME ACCORDING TO IEC-60335-1
- △5 BLOCKED CAVITY LOCATION

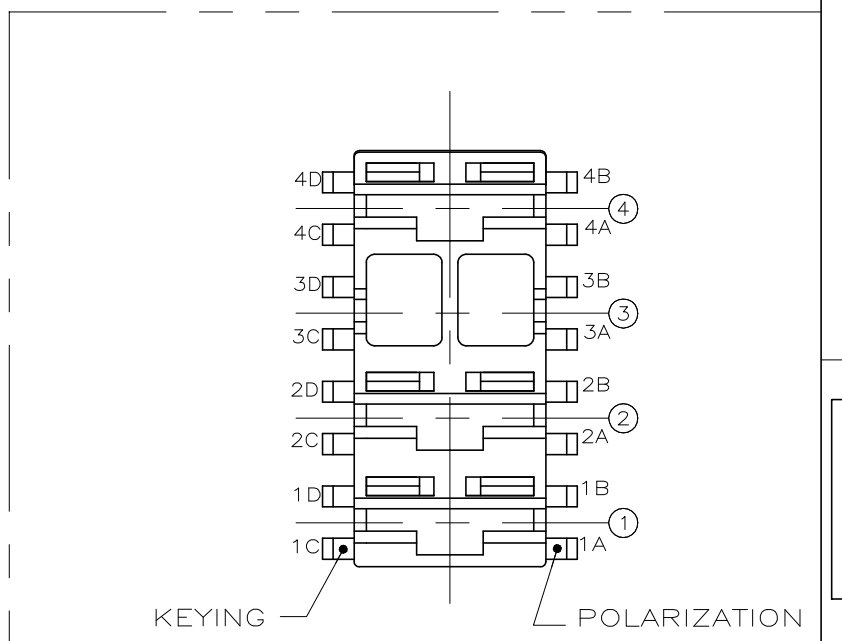
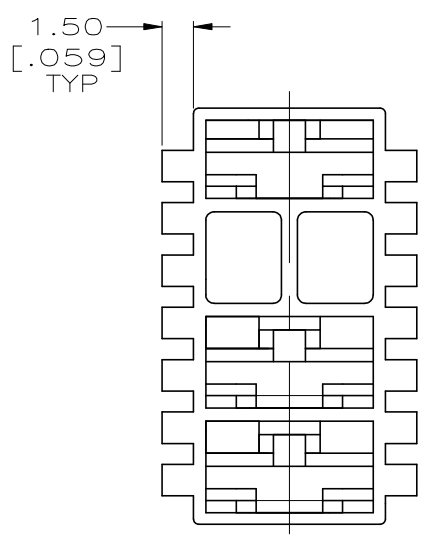
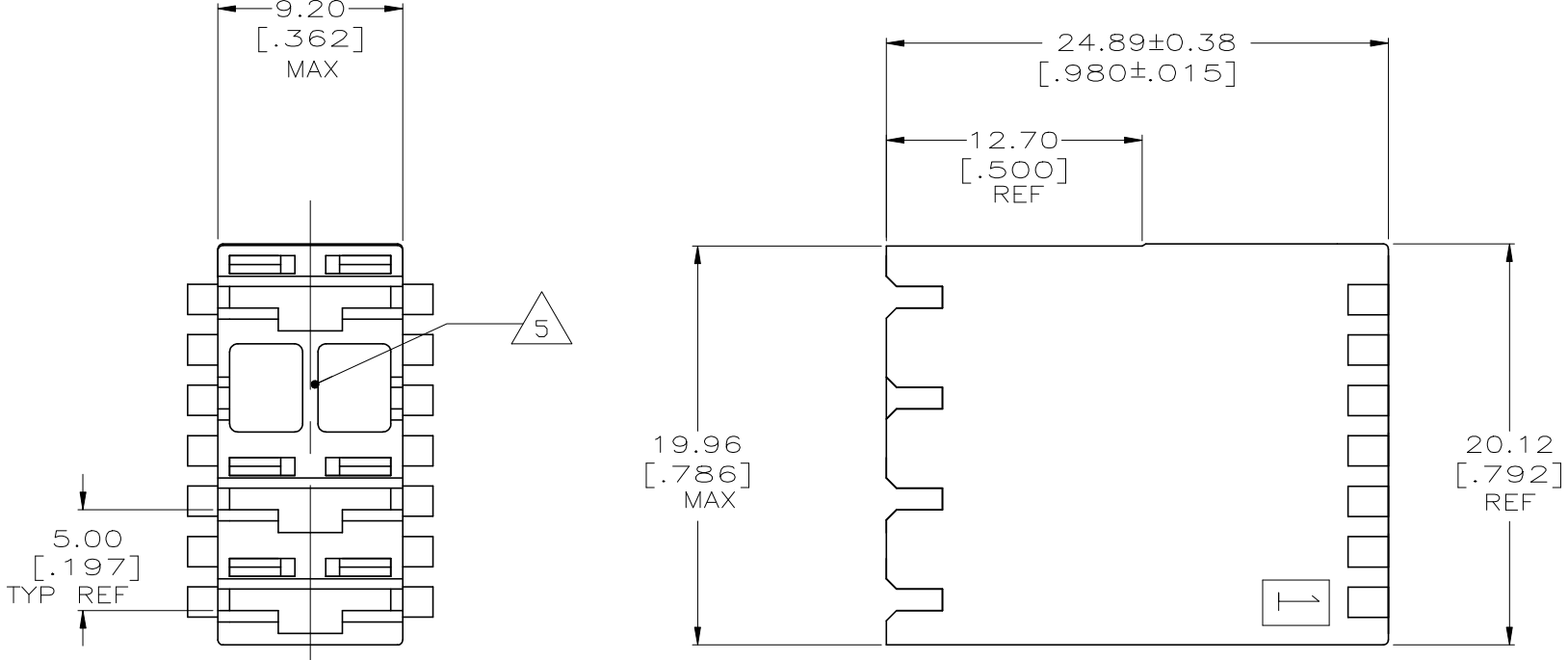

KEYING & POLARIZATION CODING AND COMBINATIONS  
 SPECIAL FRONT VIEW

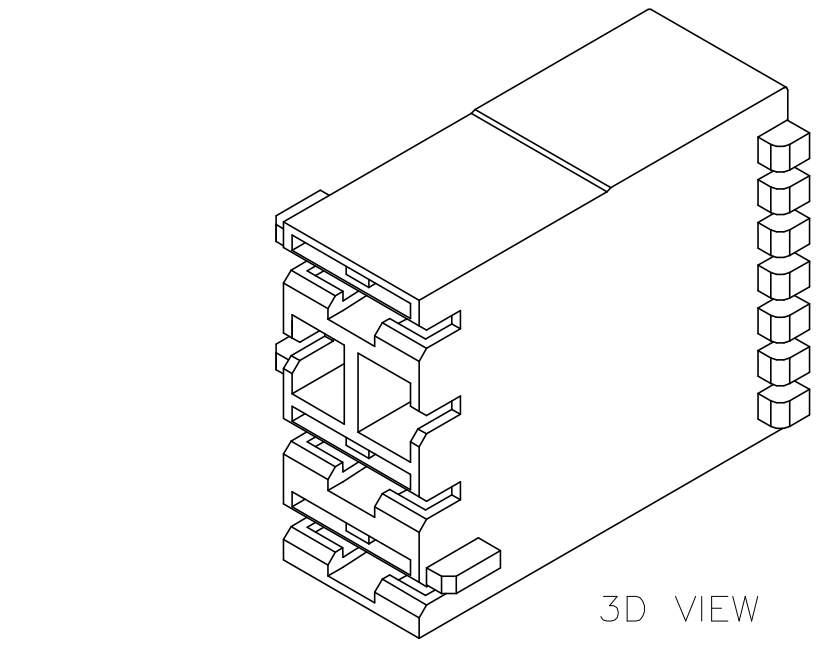

OBSOLETE	4	04-A	NATURAL	3C, 4D	1B	△4 1-521295-1
	3	---	BLUE	NONE	NONE	521295-3
	3	04-A	NATURAL	3C, 4D	1B	521295-2
	3	---	BLUE	NONE	NONE	521295-1
△5	BLOCKED CAVITY LOCATION	RAST 5 DESIGNATION	COLOR	KEYING FEATURE	POLARIZATION FEATURES	PART NO.

THIS DRAWING IS A CONTROLLED DOCUMENT.		DWN	14APROO	TE Connectivity HOUSING, RECEPT, POSITIVE-LOCK, MKIII, 6.35[.250] SERIES, 4 POSITION/3 CIRCUIT
		CHK	14APROO	
		APVD	14APROO	
		NAME	D BRATINA	
DIMENSIONS: mm		TOLERANCES UNLESS OTHERWISE SPECIFIED:		APPLICATION SPEC
		0 PLC ± - 1 PLC ± - 2 PLC ± 0.25 [.010] 3 PLC ± - 4 PLC ± - ANGLES ± -		PRODUCT SPEC
MATERIAL: NYLON		FINISH: SEE TABLE		RESTRICTED TO
		WEIGHT		SIZE: A2
		CUSTOMER DRAWING		CAGE CODE: 00779
				DRAWING NO: C-521295
				SCALE: 4:1
				SHEET: 1 OF 2
				REV: P2

REVISIONS					
P	LTR	DESCRIPTION	DATE	DWN	APVD
-		SEE SHEET 1	-	-	-

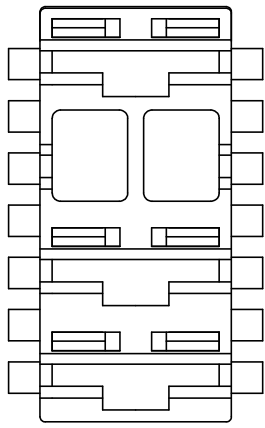
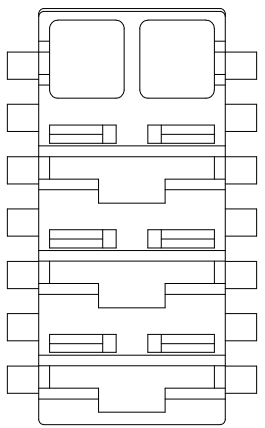
P/N	521295-*	1-521295-1
FRONT VIEW		
	BLOCKED CAVITY LOCATION	3

THIS DRAWING IS A CONTROLLED DOCUMENT.		DWN JR RUTH 14ARP2000		
DIMENSIONS: MM		CHK MS FEHER 14APR2000		
TOLERANCES UNLESS OTHERWISE SPECIFIED:		APVD D BRATINA 14APR2000	NAME HOUSING, RECEPT, POSITIVE-LOCK, MKIII, 6.35(.250) SERIES, 4 POSITION/3CIRCUIT	
0 PLC ± 1 PLC ± 2 PLC ±0.25 (.010) 3 PLC ± 4 PLC ± ANGLES ±		PRODUCT SPEC -	APPLICATION SPEC 114-2074	
MATERIAL NYLON		WEIGHT -	SIZE A2	CAGE CODE 00779
FINISH -		CUSTOMER DRAWING	DRAWING NO C=521295	RESTRICTED TO -
SCALE 4:1			SHEET 2 OF 2	REV P2

单击下面可查看定价，库存，交付和生命周期等信息

[>>TE Connectivity\(泰科\)](#)