

LOC		DIST		REVISIONS			
CM	0	REV	DESCRIPTION	DATE	BY	CHKD	APVD
S		EC 063B 0249 05		27SEP05	BSV	RCJ	
S1		REVISED PER ECO-10-000443		15JAN10	KK	AEG	

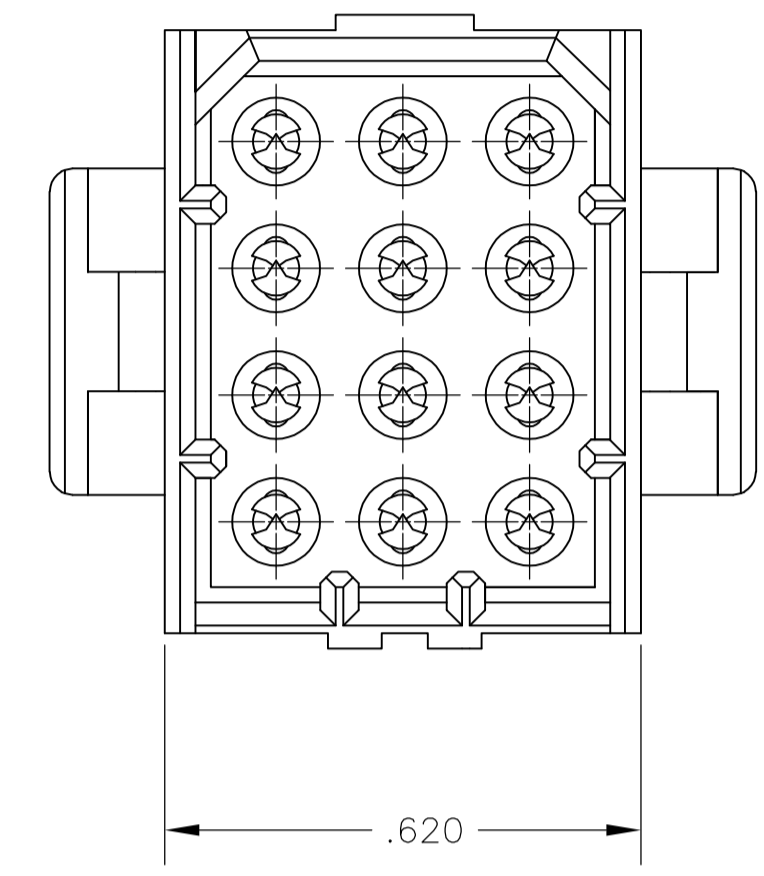

1. FITS SOCKET HOUSING 640522.
2. ASSEMBLY CONFORMS TO AMP SOLDERABILITY SPEC. 109-11-3.
3. FOR USE WITH .063 THICK P.C. BOARD.
4. CONTACT IS PLATED OVERALL WITH .000050 NICKEL, THEN .000030 GOLD OVER CONTACT LENGTH INDICATED AND .000150 MATTE TIN-LEAD ON SOLDER TAIL END.
5. UL AND CSA LOGO LOCATED ON THIS SURFACE.
6. FOR USE WITH .120 THICK P.C. BOARD.
7. FOR USE WITH .093 THICK P.C. BOARD.
8. CONTACT IS PLATED OVERALL WITH .000050 NICKEL, THEN .000030 GOLD OVER CONTACT LENGTH INDICATED AND .000150 MATTE TIN ON SOLDER TAIL END.
9. OBSOLETE PARTS: OBSOLETE CIS STREAMLINING PER D.RENAUD/D.SINISI

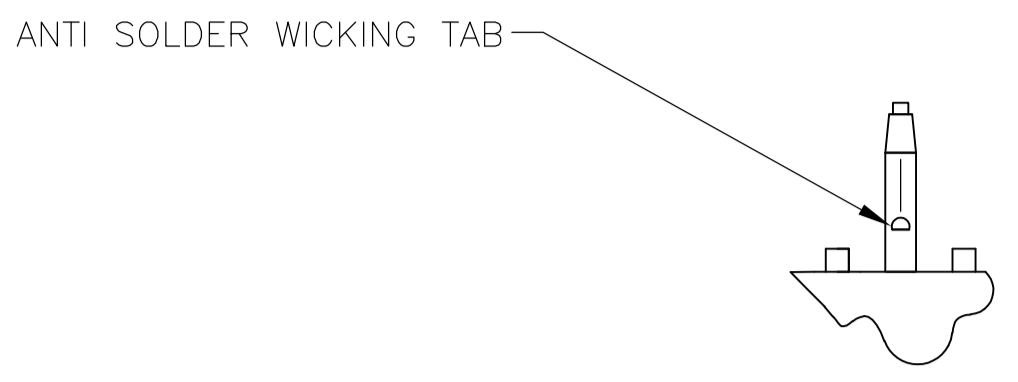
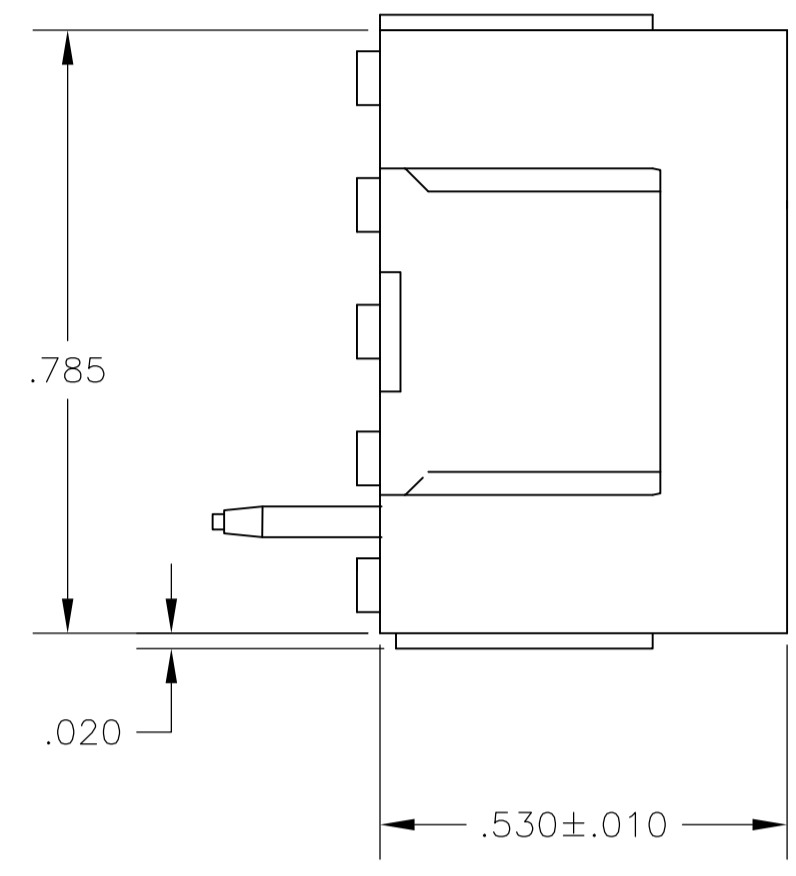
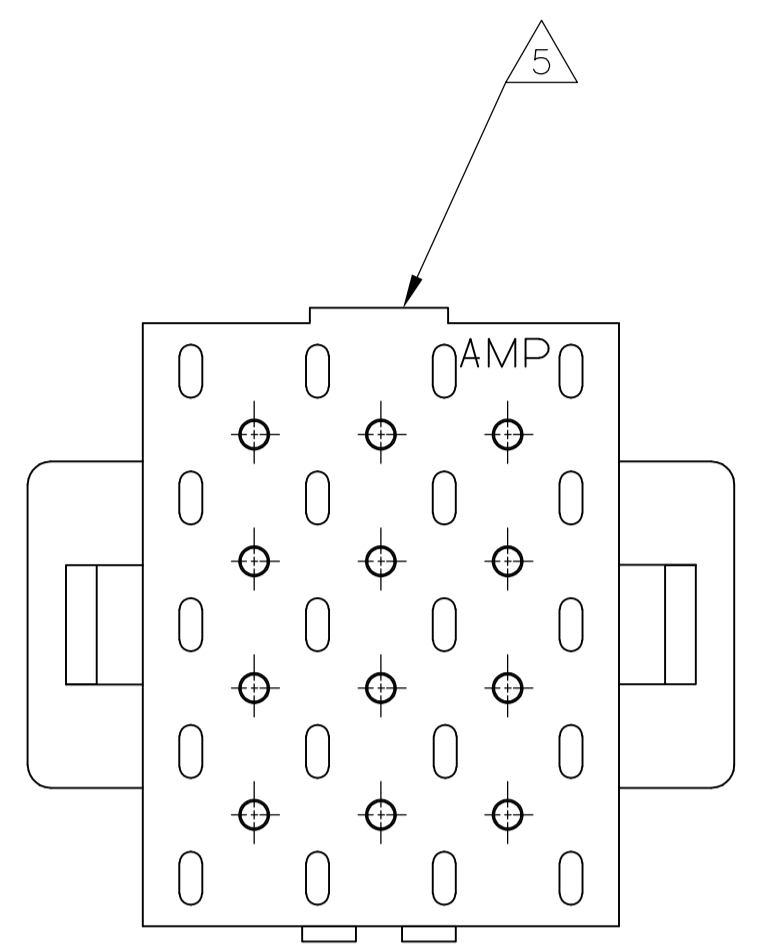
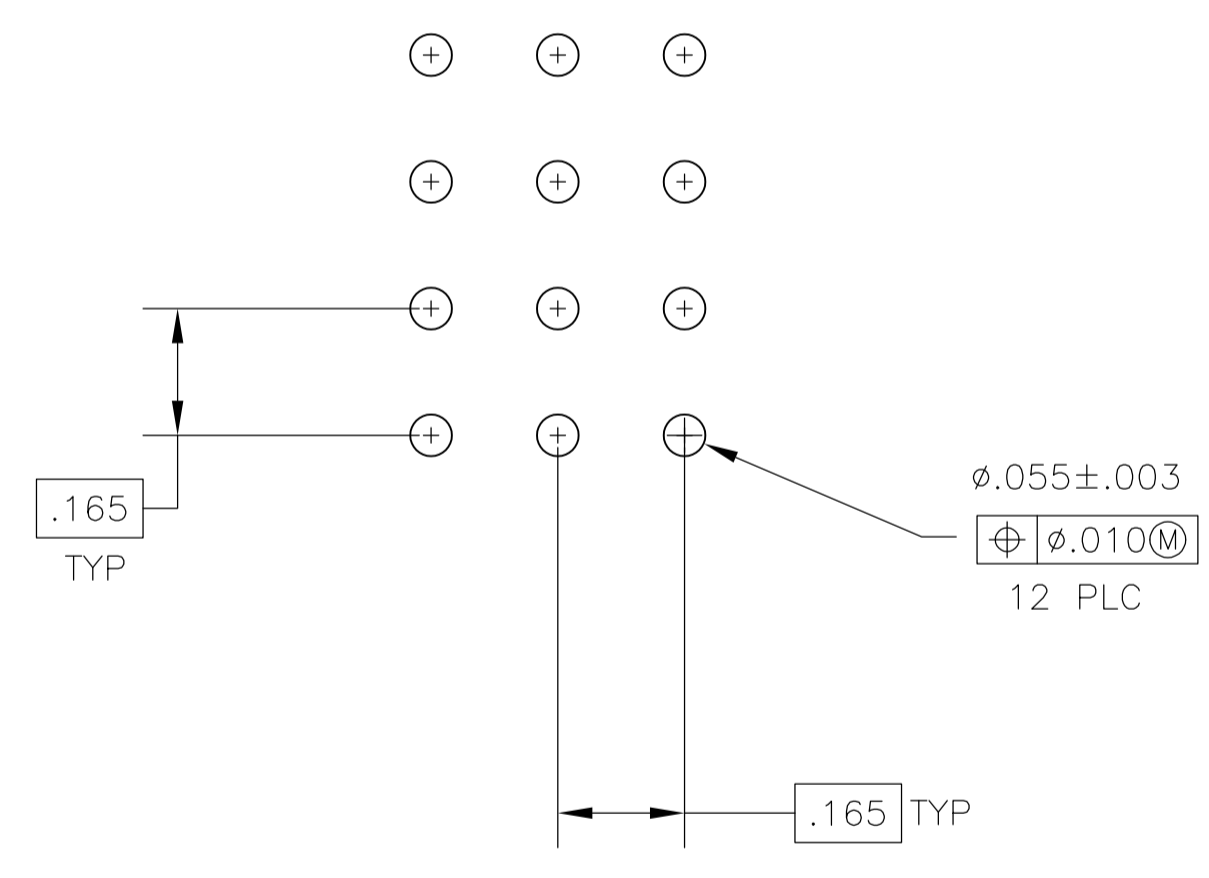

RECOMMENDED P.C. BOARD LAYOUT

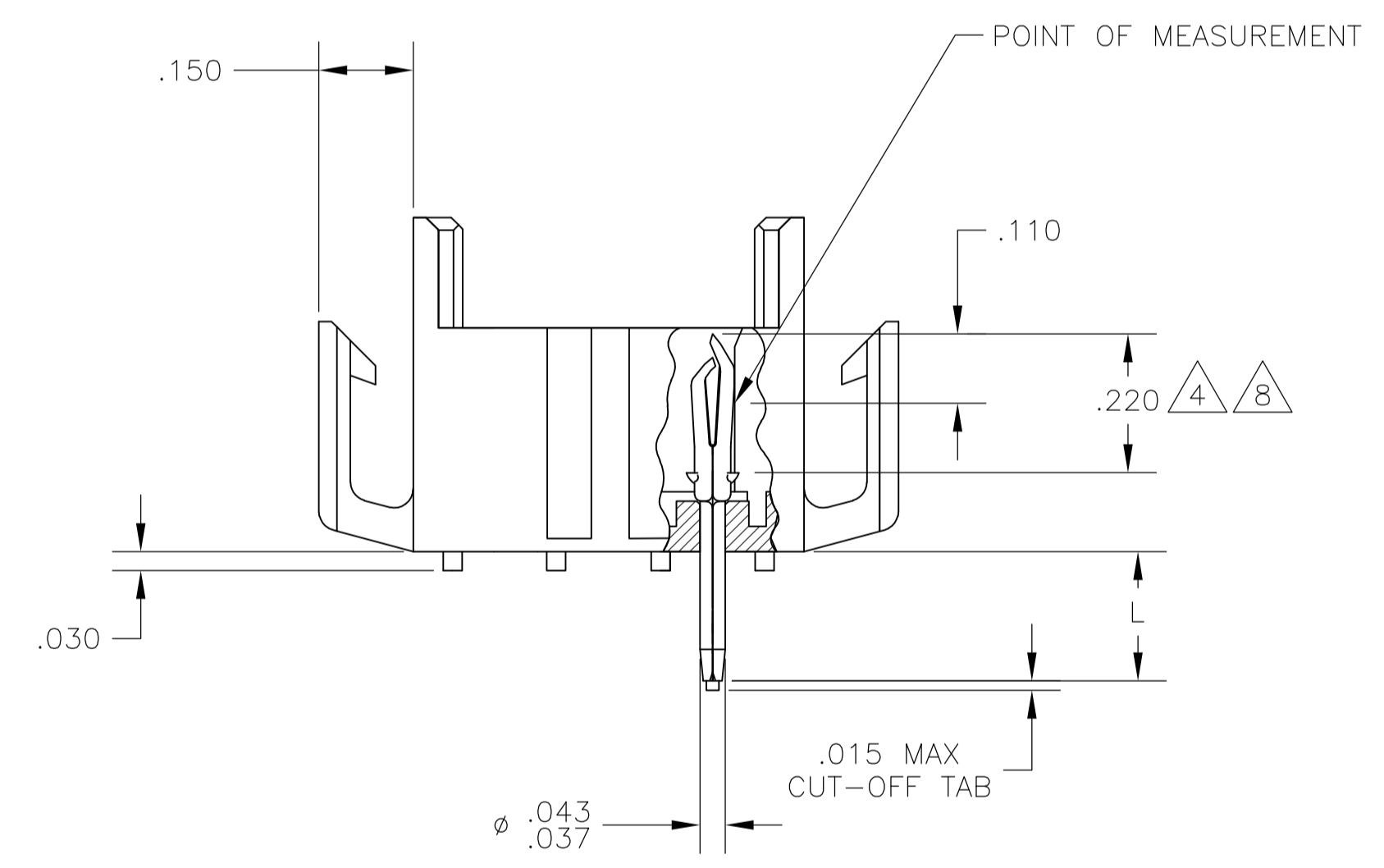

IN	MM	IN	MM	IN	MM	IN	MM
.010	0.25	.055	1.40	.210	5.33	-	-
.008	0.20	.043	1.09	.180	4.57	-	-
.005	0.13	.037	0.94	.165	4.19	.785	19.94
.003	0.08	.030	0.76	.150	3.81	.620	15.75
.000050	0.00127	.020	0.51	.110	2.79	.530	13.46
.000030	0.00076	.015	0.38	.063	1.60	.220	5.59

CONVERSION TABLE

9	OBSOLETE	.180	7	BRICK RED	GOLD	8	2-640502-6
		.210	6	BRICK RED	GOLD	8	2-640502-4
		.150	3	BRICK RED	GOLD	8	2-640502-2
	OBSOLETE	.180	7	BRICK RED	GOLD	4	640502-6
		.210	6	BRICK RED	GOLD	4	640502-4
		.210	6	BRICK RED	PRE-TIN		640502-3
		.150	3	BRICK RED	GOLD	4	640502-2
		.150	3	BRICK RED	PRE-TIN		640502-1
		"L" +.010 -.020		HOUSING COLOR	PIN FINISH		PART NUMBER

THIS DRAWING IS A CONTROLLED DOCUMENT.

DIMENSIONS: INCHES	TOLERANCES UNLESS OTHERWISE SPECIFIED:	0 PLC ± -	1 PLC ± -	2 PLC ± -	3 PLC ± -.005	4 PLC ANGLES ± 0° 30'
--------------------	--	-----------	-----------	-----------	---------------	-----------------------

MATERIAL: HOUSING FLAME RETARDANT NYLON, UL 94V-0 PIN, .008 PH BRZ. FINISH: SEE FINISH.

APPROVED: J. HUFFMAN, R. SWING, T. REDDICK

DATE: 28 APR 98

NAME: T. REDDICK

PRODUCT SPEC: NAME

APPLICATION SPEC: NAME

SIZE: A1

SCALE: 4:1

SHEET: 1 of 1

REV: S1

CUSTOMER DRAWING

SCALE: 4:1

SHEET: 1 of 1

REV: S1

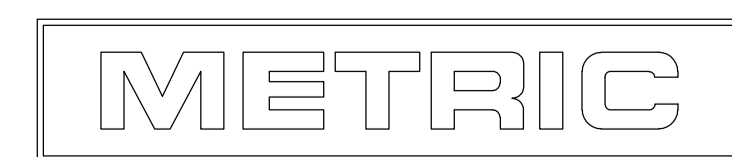

单击下面可查看定价，库存，交付和生命周期等信息

[>>TE Connectivity\(泰科\)](#)