

LOC		DJUST		REVISIONS			
P	LTR	DESCRIPTION	DATE	DWN	APVD		
E		REV & REDWN PER EC OL30-0073-96	10-11-96	JH	RS		

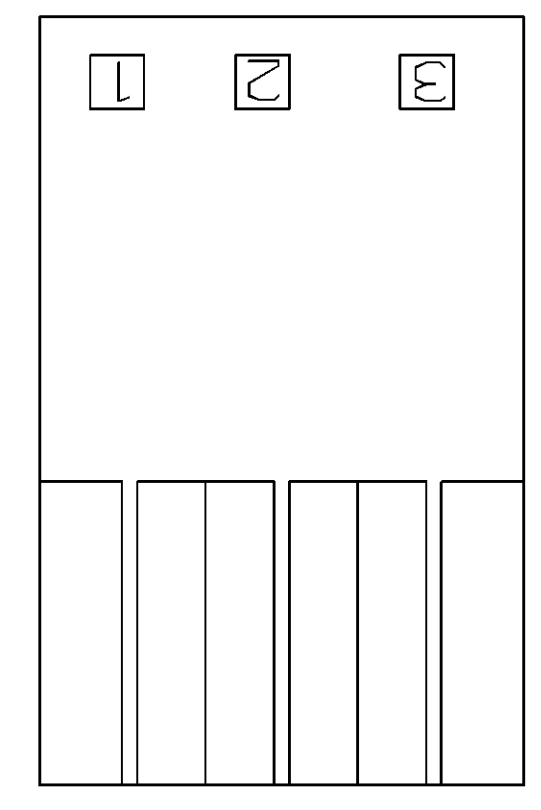

△1 MATERIAL: NYLON UL94V-2 (NATURAL).
 △2 MARKING FOR UL LOGO AND CSA LOGO LOCATED APPROXIMATELY AS SHOWN.

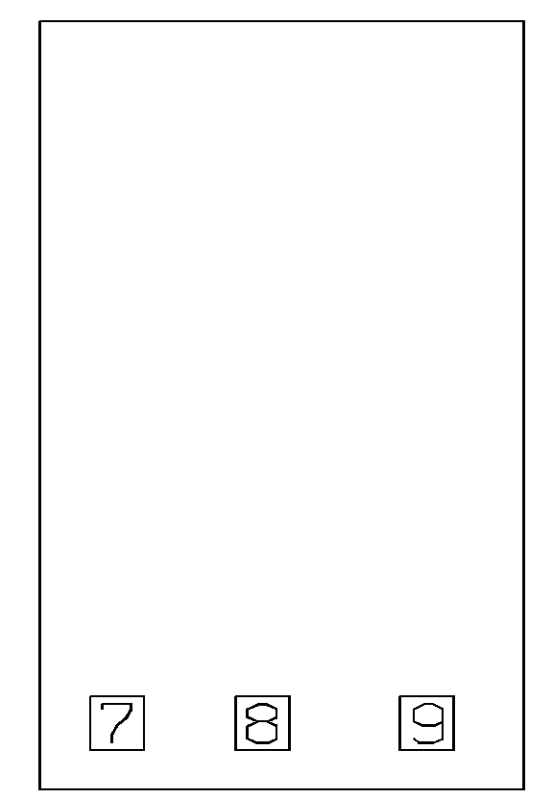
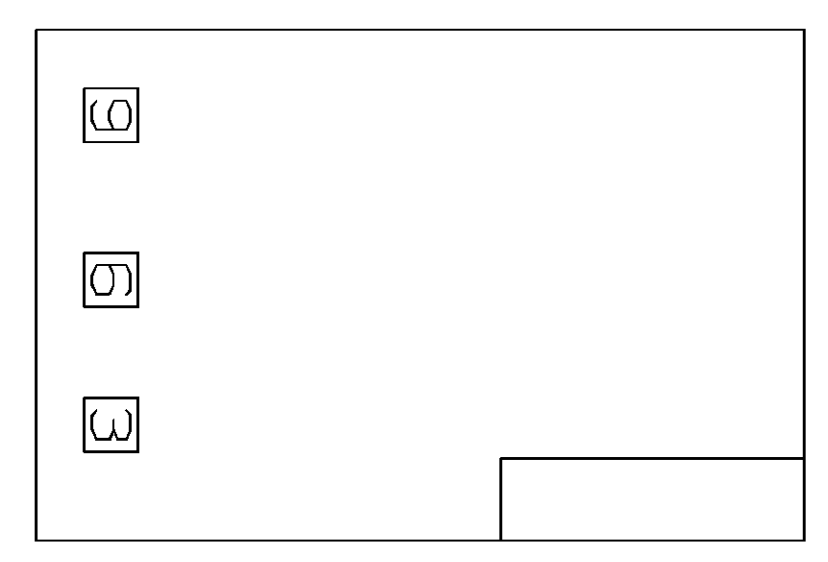
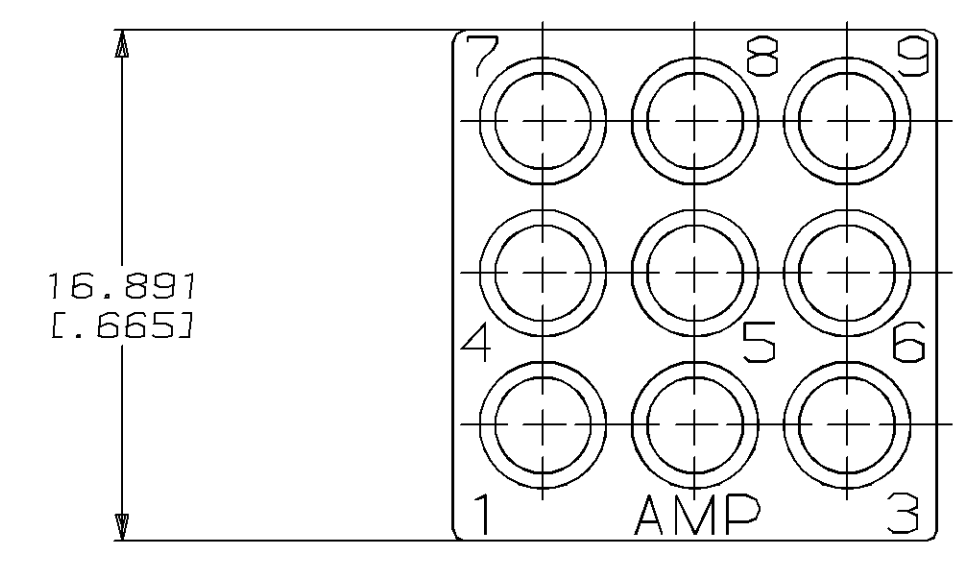
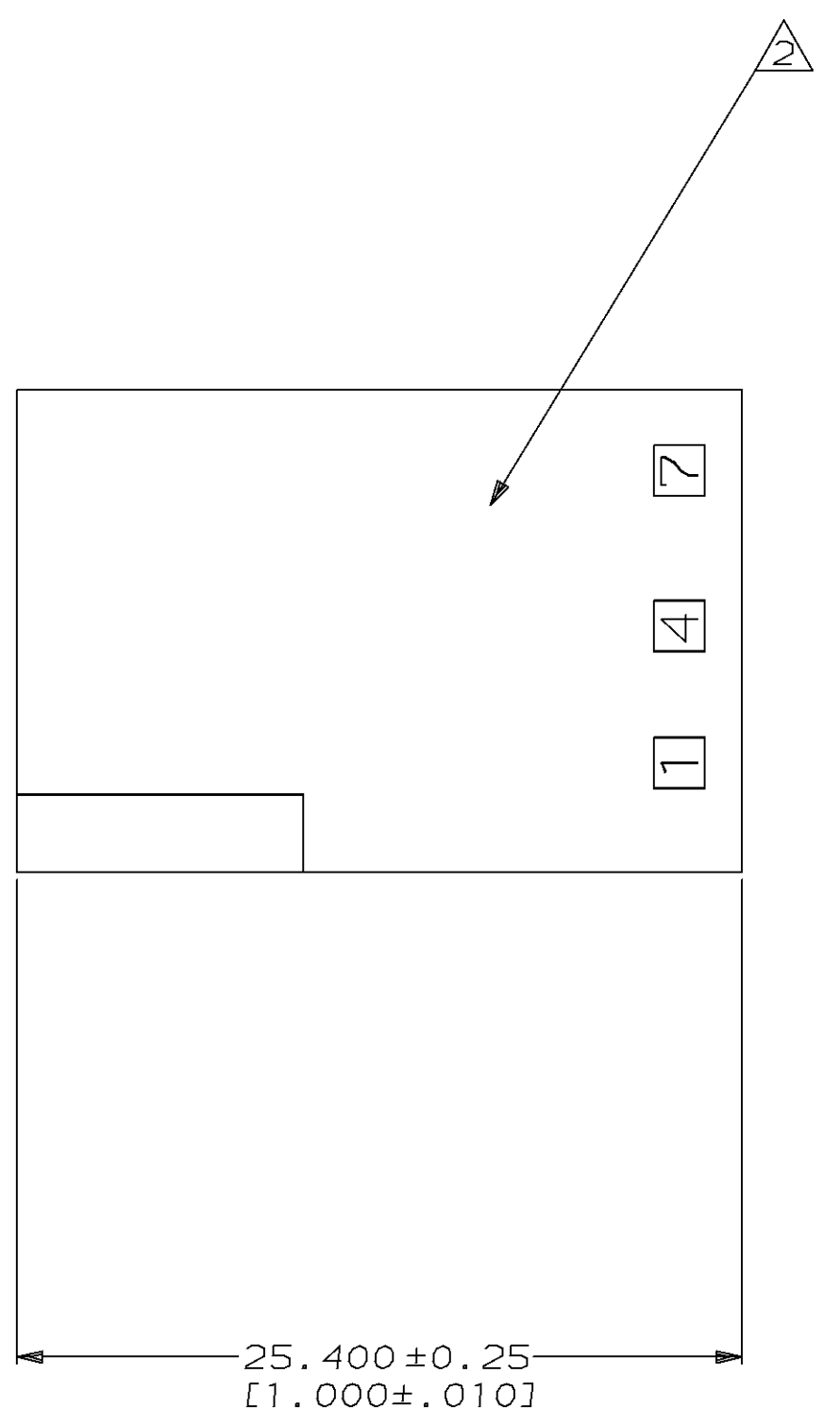
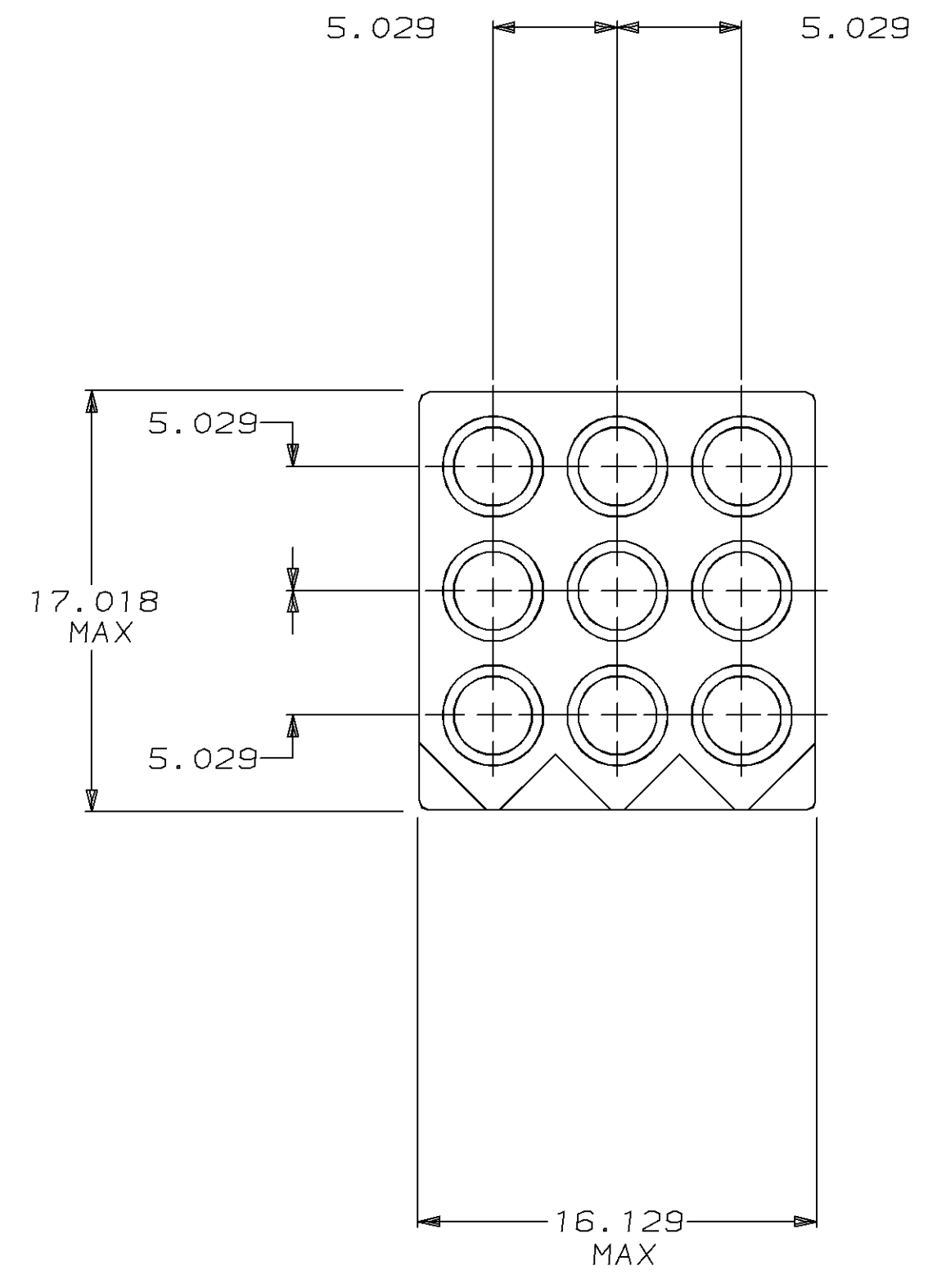
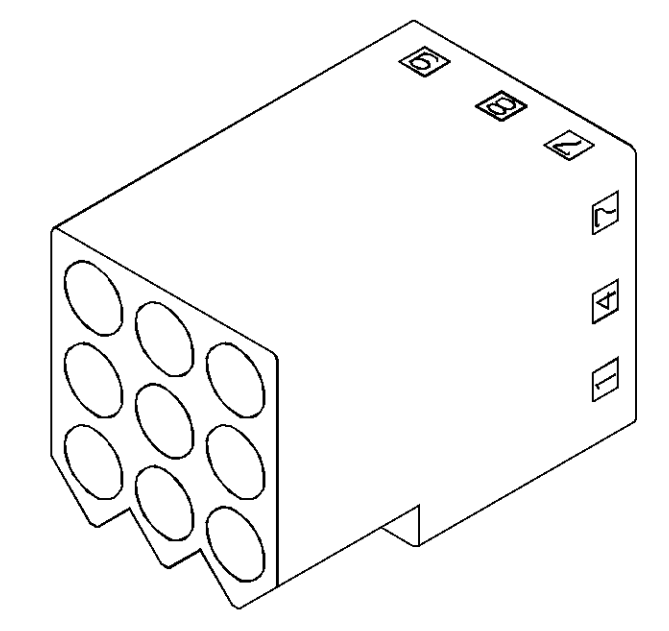

3D MODEL NTS

METRIC

770094-1
PART NUMBER

THIS DRAWING IS A CONTROLLED DOCUMENT.		DWN J. HUFFMAN 10-11-96	AMP Incorporated Harrisburg, PA 17105-3608
DIMENSIONS: INCHES		CHK R. SWING 10-11-96	NAME C. CASH 10-16-96
TOLERANCES UNLESS OTHERWISE SPECIFIED:		APVD C. CASH 10-16-96	PRODUCT SPEC
0 PLC	±-	APPLICATION SPEC	SIZE A1
1 PLC	±-	RESTRICTED TO	CARE CODE
2 PLC	±-	WEIGHT	DRAWING NO
3 PLC	±0.13	CUSTOMER DRAWING	770094
4 PLC	±-	SCALE	4:1
ANGLES	±-	SHEET	1 OF 1
FINISH	-	REV	E

单击下面可查看定价，库存，交付和生命周期等信息

[>>TE Connectivity\(泰科\)](#)