

WDF 82-9167-4  
SMA

Zeichnung geschützt durch © Copyright 1982 AMP DEUTSCHLAND GmbH Alle Rechte vorbehalten	Index	Anderung	Tag	Name

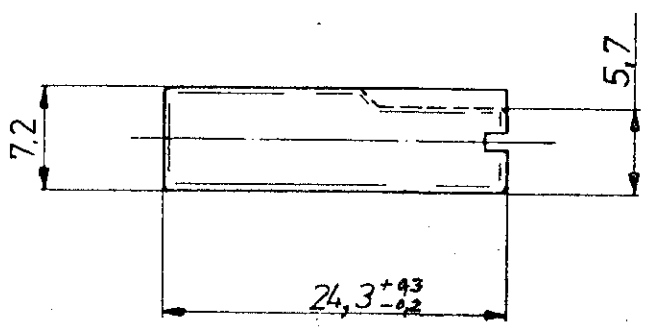

Schnitt section A-A

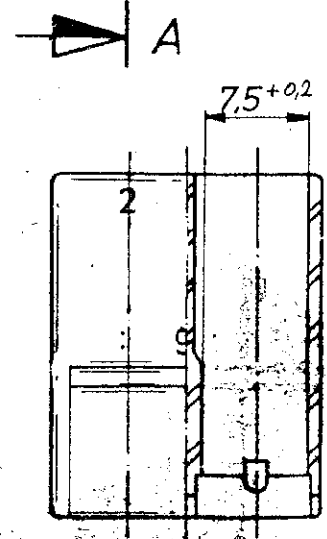
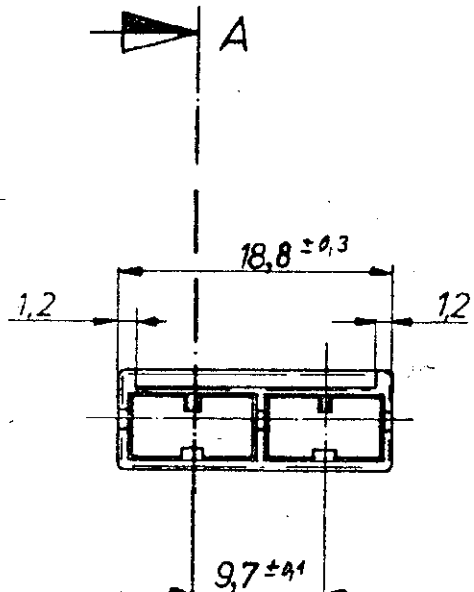
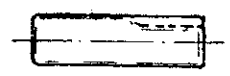
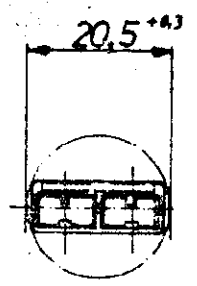
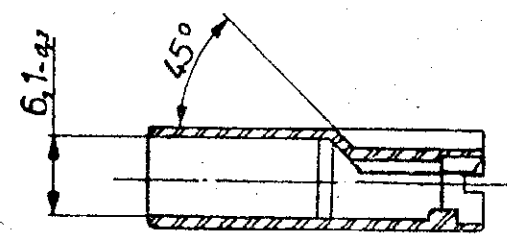

Maßstab scale 1:1

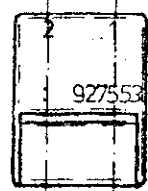

Anderungen, die dem technischen Fortschritt dienen, behalten wir uns vor.

		<b>AMP</b> AMP DEUTSCHLAND GmbH Langen b Ffm	
		Benennung <b>2 pol. POSITIVE LOCK Gehäuse</b>	
927 553-1	PA 6.6	<b>schwarz</b>	
Bestell-Nr.	Werkstoff	Oberfläche Farbe	Nicht tolerierte Maße ± 0,2 mm ± 1°-30'
Gez. 11.3.85 Druft	12.3.85 Wly	Gepr.	Format <b>B</b> Zeichnungs-Nr. <b>927 553</b>
		Maßstab <b>2:1</b>	Blatt-Nr. <b>1 von 1</b>

K

单击下面可查看定价，库存，交付和生命周期等信息

[>>TE Connectivity\(泰科\)](#)