

# HIGH VOLTAGE DC CONTACTOR ECK100B SERIES

UP TO 150AMP, BI-DIRECTIONAL

## INTRODUCTION

TE Connectivity (TE)'s ECK100B series high-voltage DC contactor is designed for control in high voltage applications like battery energy storage system, solar inverters, and EV charging applications. It can be used in 1000VDC voltage systems and the enhanced contacts design provides for higher electrical endurance. The contacts provided in this series allows bi-directional load and are hermetically sealed with ceramic sealing technology, making it safer and reliable.

## FEATURES

- Hermetically sealed with ceramic technology
- Allow bi-directional load for main contacts
- Continuous current carrying capacity of up to 150A
- Enhanced breaking capacity up to 1000VDC
- Auxiliary contact version available
- Compatibility with DC-1 utilization category in IEC60947-4-1

## APPLICATIONS

- DC charging station
- Electric vehicle
- Automated Guided Vehicles (AGV)
- Electric forklift
- Battery energy storage systems
- Photovoltaic inverter

## APPROVALS

- UL: E82292
- TUV: R50616669
- CE: 724\_00007
- CCC approved

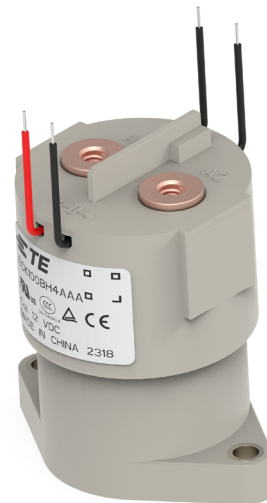

# High Voltage DC Contactor ECK100B Series

## CONTACT DATA

Contact current	150A(at 40°C) 100A(at 85°C)
Maximum switching voltage	1000VDC
Contact arrangement	1 Form X (SPST-NO-DM)
Initial contact voltage drop	≤80mV (100A, after 1 minute)
Maximum short circuit current	1500A, 30ms 1000A, 50ms
Operate time, maximum (at 23 °C)	30ms
Release time, maximum (at 23°C)	10ms
Mechanical life	250,000 cycles

### Note:

For contact current of 150A (at 40°C), recommended connection conductor size is AWG 2 (33.6mm<sup>2</sup>). For contact current 100A (at 85°C), recommended connection conductor size AWG 4 (21.2mm<sup>2</sup>). Smaller conductor size are also applicable but end users are requested to verify with application requirements and take active cooling actions to support long term performance.

## CONTACT RATINGS

Load	Cycles
100A, 450 VDC, make/break, resistive	6,000
100A, 800VDC, make/break, resistive	1,000
100A, 1000VDC, make/break, resistive	1,000
150A, 1000VDC, make/break, resistive	100
300A, 500VDC, make/break, resistive	5

## CE DECLARATION (IEC60947-4-1)

Rated Operational Current	Utilization Category	Switching Cycles
50A	DC-1	6,050

## COIL VERSIONS, DC COIL

Coil code	Nominal voltage	Nominal operating current	Operate voltage	Maximum operating voltage	Release voltage	Coil power
4	12VDC	0.462A	≤9VDC	13.2VDC	≥1.2VDC	5.5W
5	24VDC	0.249A	≤18VDC	26.4VDC	≥2.4VDC	6W
6	48VDC	0.122A	≤36VDC	52.8VDC	≥4.8VDC	6W

All figures are given for coil without pre-energization, at ambient temperature +23°C.

## AUXILIARY CONTACT DATA

Contact form	1 Form A (SPST-NO)
Contact current, maximum	2A, 30VDC
Contact current, minimum	10mA, 24VDC
Contact resistance, maximum	0.4Ω at 30VDC / 0.15Ω at 125VAC

## INSULATION DATA

<b>Dielectric withstand voltage (leakage current &lt;1mA)</b>	
between open main contacts	4,300Vrms
between main contact and coil	4,300Vrms
between main contacts and auxiliary contacts	4,300Vrms
between open auxiliary contacts	750Vrms
<b>Initial insulation resistance at 1000VDC</b>	
between insulated elements	> 1x10 <sup>9</sup> Ω

Note: End of life is reached when insulation resistance is <50MΩ @ 1,000V.

## OTHER DATA

Material compliance: EU RoHS/ELV, China RoHS, REACH, and for halogen content refer to the product Compliance Support Center at <a href="http://www.te.com/customer-support/rohssupportcenter">www.te.com/customer-support/rohssupportcenter</a>	
Protection category	IP67
Ambient temperature	-40°C to 85°C
Shock 11ms ½ sine (functional)	20G peak
Vibration sine, peak (functional)	6G, 10 Hz - 2000 Hz
Terminal type	Screw for main load contact, wire for coil and auxiliary contact
Weight	0.18kg

# High Voltage DC Contactor ECK100B Series

## DIMENSIONS (Unit: mm)

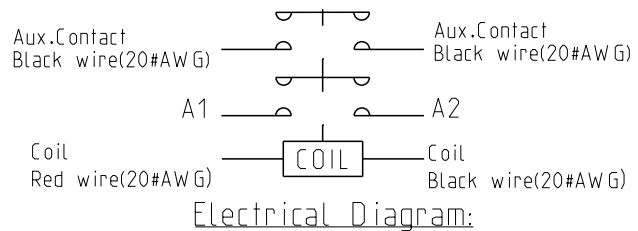
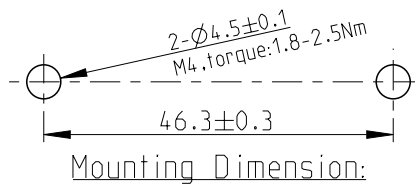
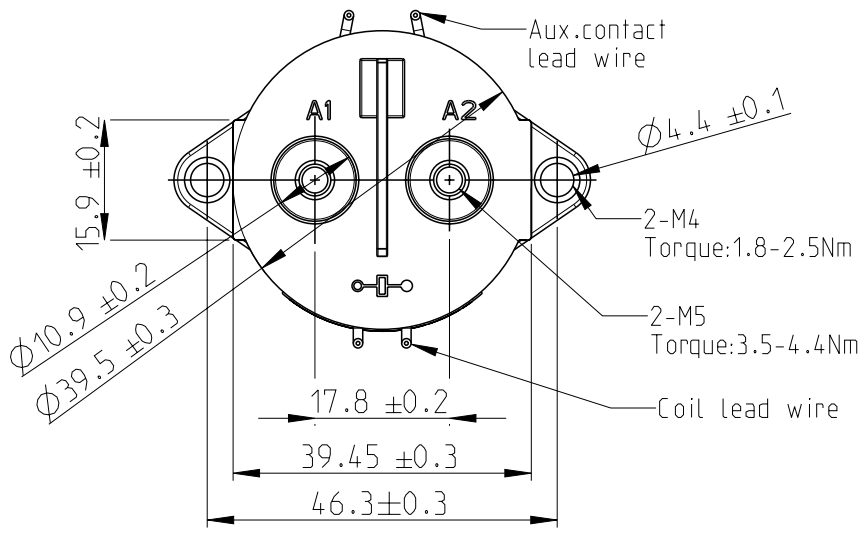
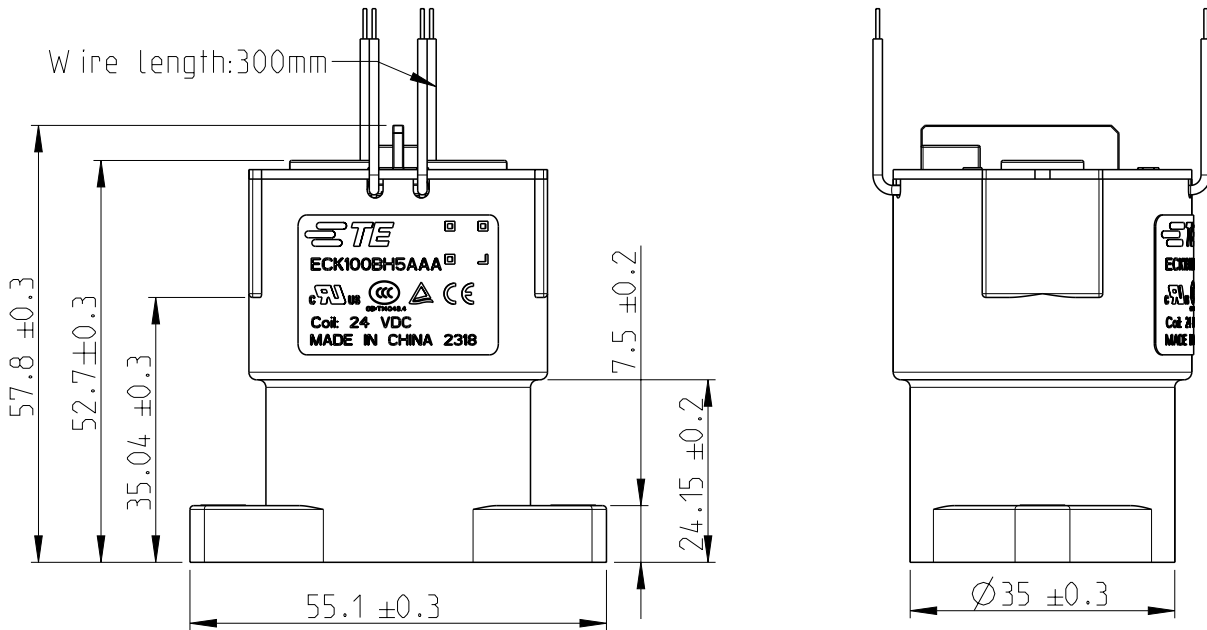

### Notes:

1. ECK100B series, non-polarized, 1 form A of main contact, gas-filled and ceramic seal contactor.
2. Lead wire: UL3266, 20AWG, 300V, -40°C to 125°C. Customized length of lead wire is available.
3. Product require label marking.
4. Coil voltage 12VDC and 24VDC are available.

# High Voltage DC Contactor ECK100B Series

## CURRENT CARRYING CAPABILITY CURVE

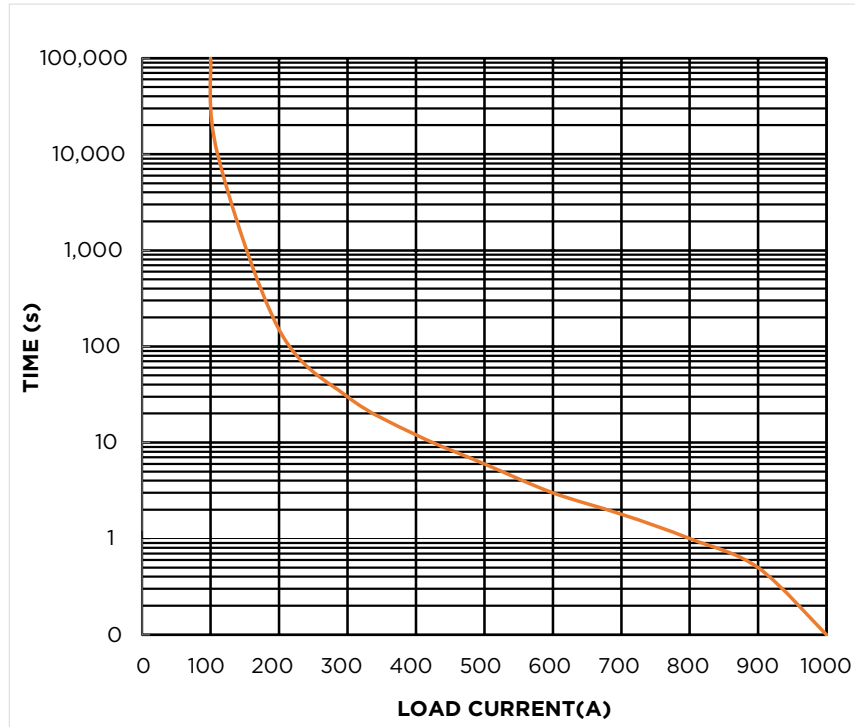

**Note:**

1. The data is measured at the environment temperature 85°C with cross section area of wire 35mm<sup>2</sup> min.

## ESTIMATED MAKE AND BREAK POWER SWITCHING RATINGS

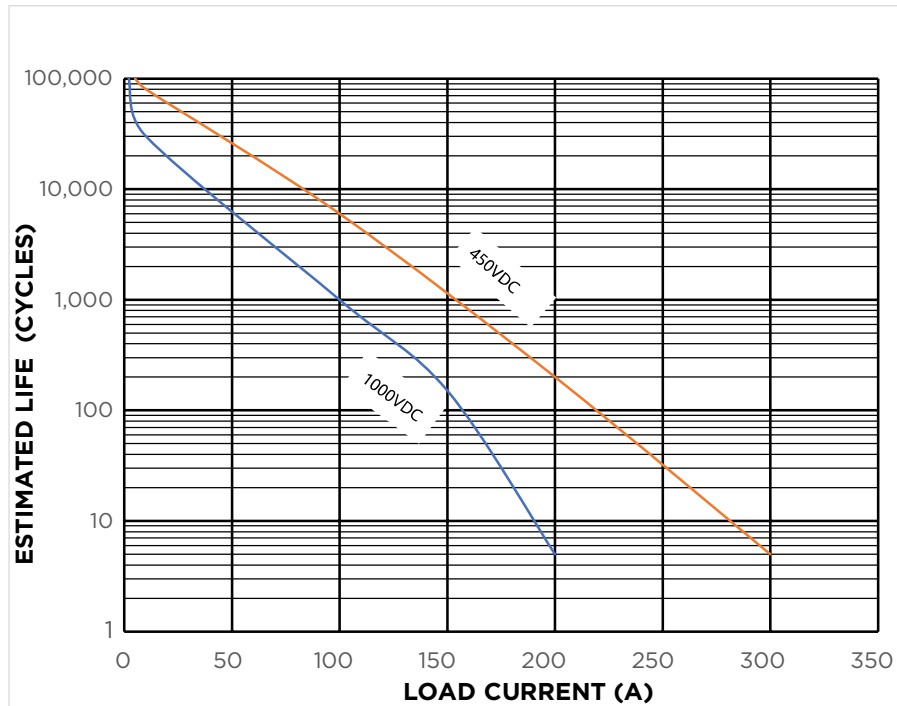

**Notes:**

1. The curve was created based on extrapolated data with few typical points, users are recommended to confirm performance in actual application.
2. The typical data were estimated with resistive load at room temperature.

## ORDERING INFORMATION

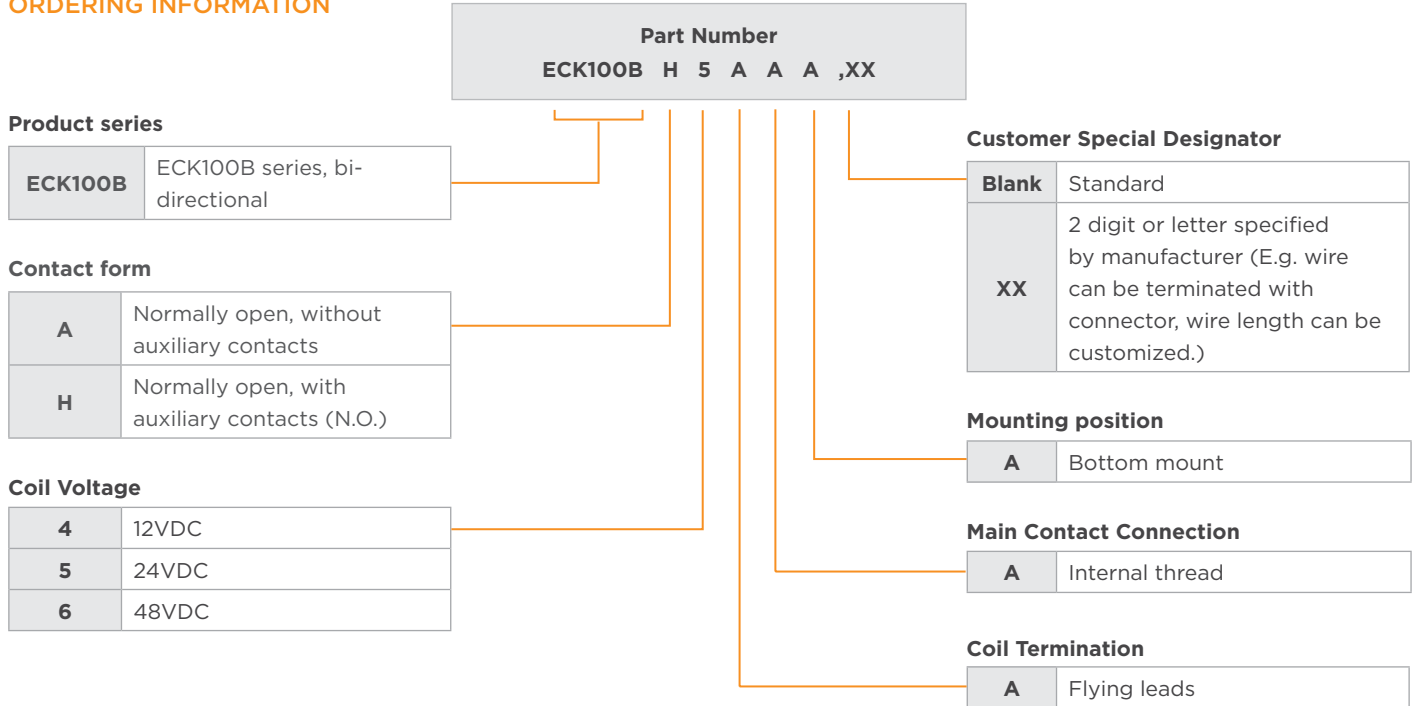

## PRODUCT PART NUMBER TABLE

Product Code	Contact Form	Mounting Position	Main Contact Connection	Coil	Part Number
ECK100BH4AAA	Normally open + Auxiliary contact (N.O)	Bottom	Internal thread	12VDC	<a href="#">2071583-1</a>
ECK100BH5AAA	Normally open + Auxiliary contact (N.O)			24VDC	<a href="#">2071583-2</a>
ECK100BA4AAA	Normally open			12VDC	<a href="#">2071583-4</a>
ECK100BA5AAA	Normally open			24VDC	<a href="#">2071583-5</a>

Note: Only typical part numbers are listed above, other types please contact TE engineer.

## CAUTIONS

- Do not use the contactor when contactor is dropped or broken.
- Avoid mounting the contactor with the main contact screw terminals in downward direction, otherwise the contactor performance will not be achieved.
- Please drive the contactor coil through the fast rising (step type power supply mode), otherwise the contactors will not operate.
- If using with diodes for coil, it may lead to a decline in product switching performance.
- Please consider electromagnetic interference when using the product.
- Screw locking torque of main contact terminals should be 3.5N·m - 4.4N·m for M5 screw. Screw locking torque of contactor bottom mounting should be 1.8N·m - 2.5N·m for M4 screw.

## te.com

©2024 TE Connectivity Ltd. Family of Companies. All Rights Reserved.

TE Connectivity, TE connectivity (logo) and Every Connection Counts are trademarks owned or licensed by the TE Connectivity family of companies. All other logos, products and/or company names referred to herein might be trademarks of their respective owners.

While TE has made every reasonable effort to ensure the accuracy of the information in this document, TE does not guarantee that it is error-free, nor does TE make any other representation, warranty or guarantee that the information is accurate, correct, reliable or current. TE reserves the right to make any changes to the information contained herein without prior notice. TE Connectivity assumes only those obligations set forth in the terms and conditions for this product and shall in no event be liable for any incidental, indirect, or consequential damages arising out of the sale, resale, use, or misapplication of the product. TE expressly disclaims any implied warranties with respect to the information contained herein, including, but not limited to, implied warranties of merchantability or fitness for a particular purpose. Dimensions, specifications and/or information contained herein are for reference purposes only and are subject to change without notice. Consult TE for the latest dimensions, specifications and/or information. Users of TE Connectivity products must make their own assessment as to whether the respective product is suitable for the respective desired application.

02/24 ED

单击下面可查看定价，库存，交付和生命周期等信息

[>>TE Connectivity\(泰科\)](#)