

THIS DRAWING IS UNPUBLISHED. RELEASED FOR PUBLICATION
 © COPYRIGHT BY ALL RIGHTS RESERVED.

LOC		DIST		REVISIONS					
DY		-		P	LTR	DESCRIPTION	DATE	DWN	APVD
				A4		REVISED PER ECO-11-005139	19MAR11	RK	HMR

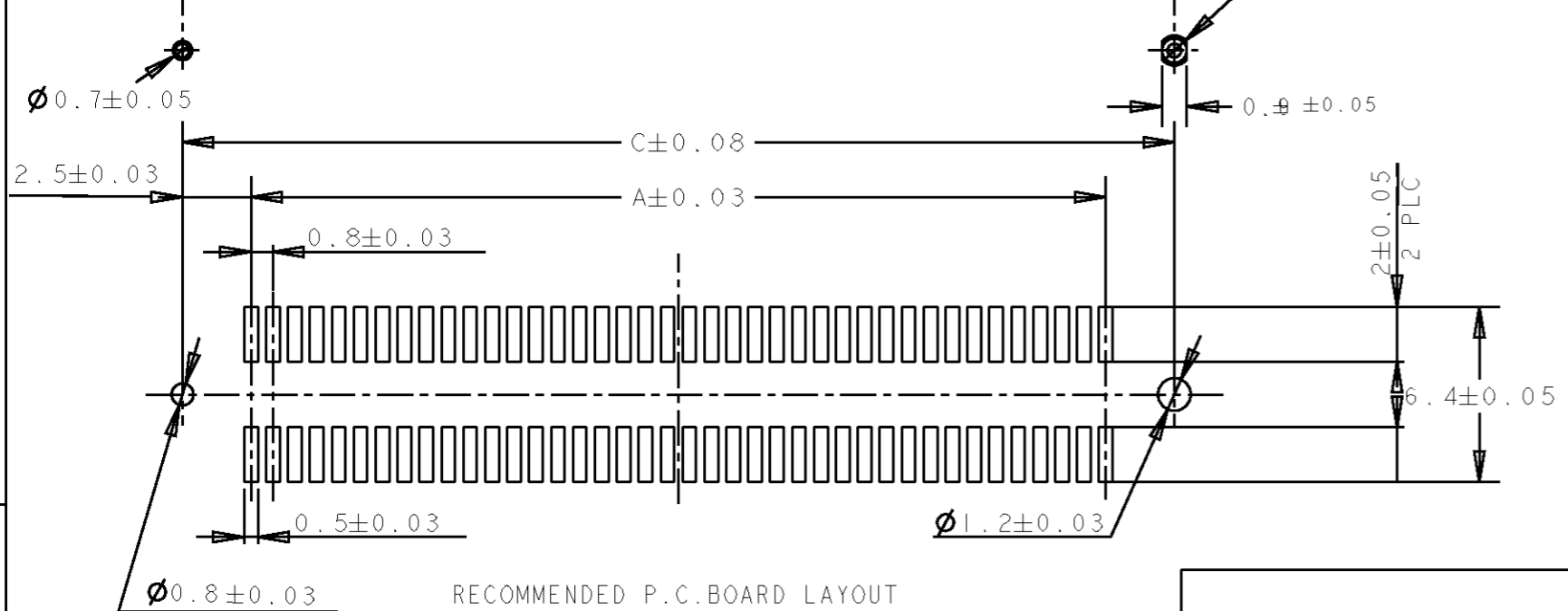
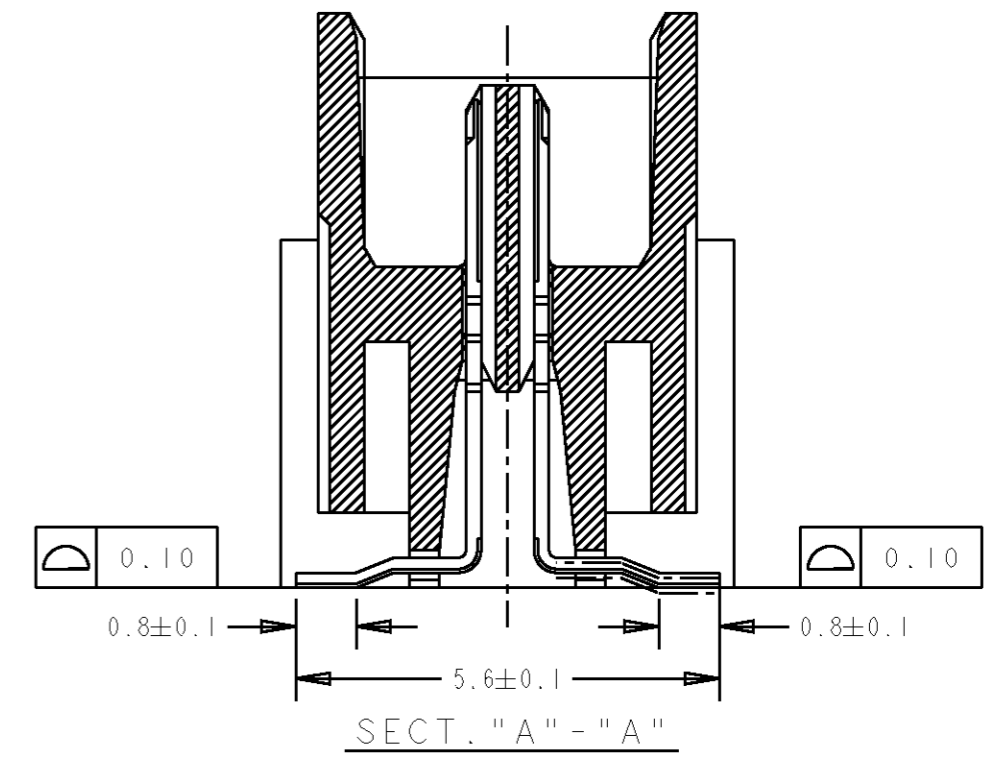
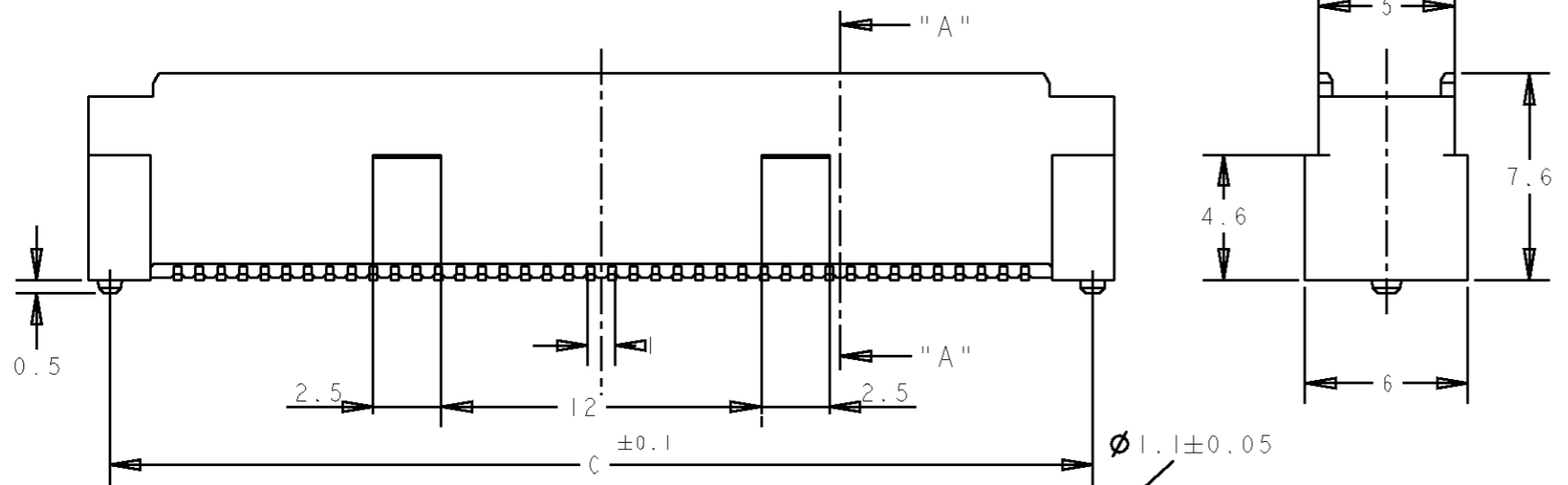
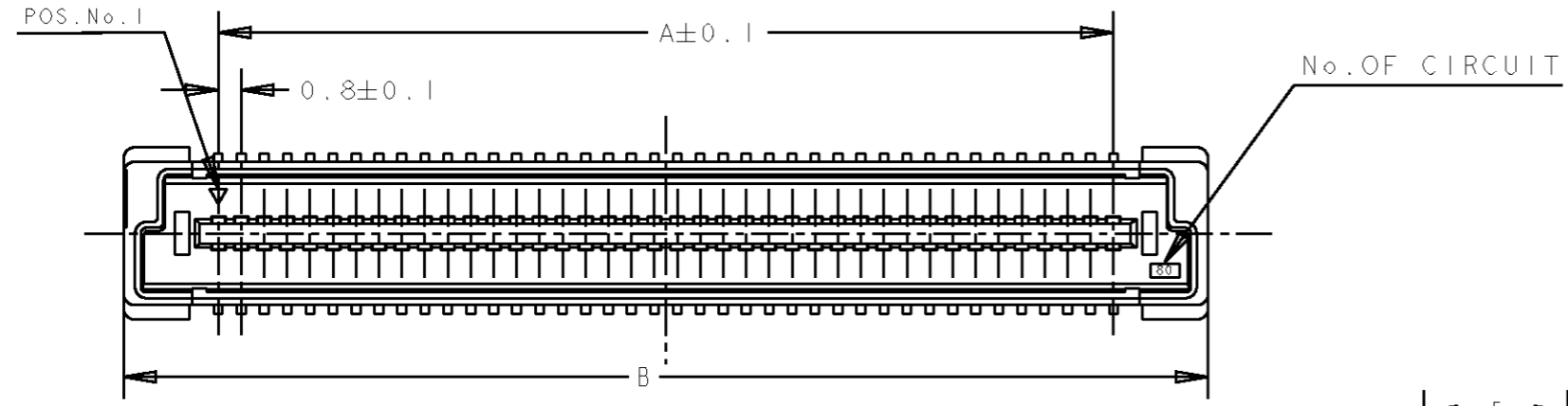

- NOTES:
- 1. MATERIAL:
HOUSING: L.C.P.(HIGH TEMP THERMO PLASTIC)
UL 94V-0, NATURAL.
CONTACT: BRASS.
 - 2. FINISH:
CONTACT AREA: 0.0002 MIN GOLD
SOLDERING AREA: 0.0020 MIN MATTE-TIN
UNDERPLATE: 0.0013 MIN NICKEL ALL OVER
 - 3. POSITION SERIES: SEE TABLE.
 - 4. CONN STACK HEIGHT COMBINE OF PLUG "Y"H VS REC "X"H.
STACK HEIGHT = Y + X - 5
 - 5. OBSOLETE PARTS: OBSOLETE CIS STREAMLINING PER D.RENAUD/D.SINISI

DIMENSIONS: mm		TOLERANCES UNLESS OTHERWISE SPECIFIED:		DWN 28 JUL 04 FLORENCE TAN		STE TE Connectivity	
		0 PLC ±- 1 PLC ±0.30 2 PLC ±0.25 3 PLC ±0.20 4 PLC ±- ANGLES ±3°		CHK ERIC TNG			
MATERIAL		FINISH		APVD SEIFONG		SIZE	
				PRODUCT SPEC 108-5390		CAGE CODE 00779	
				APPLICATION SPEC 114-5254		DRAWING NO C-5179031	
				WEIGHT -		SCALE 4:1	
				CUSTOMER DRAWING		SHEET 1 OF 2	
						REV A4	

THIS DRAWING IS UNPUBLISHED. RELEASED FOR PUBLICATION .19 .
 © COPYRIGHT BY ALL RIGHTS RESERVED.

LOC DY	DIST -	REVISIONS			
P	LTR	DESCRIPTION	DATE	DWN	APVD
		SEE SHEET 1			

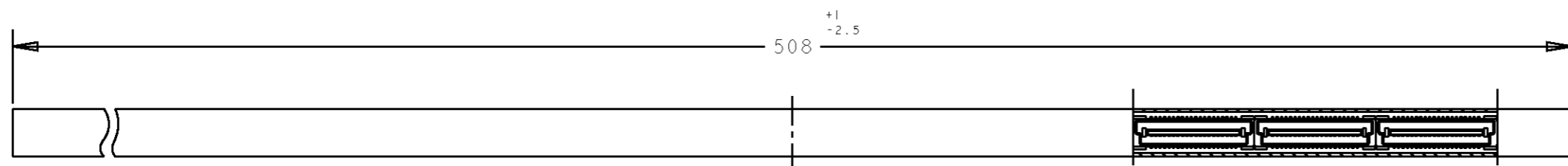

SECT A-A

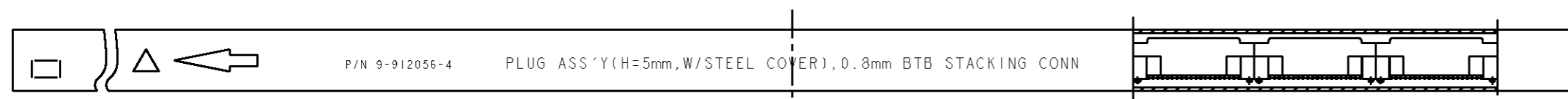

SECT B-B

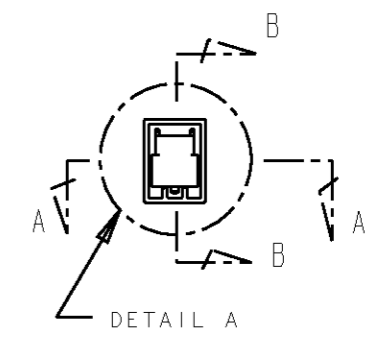

P/N 9-912056-4 PLUG ASS'Y (H=5mm, W/STEEL COVER), 0.8mm BTB STACKING CONN

REFERENCE PICTURE OF TUBE PACK

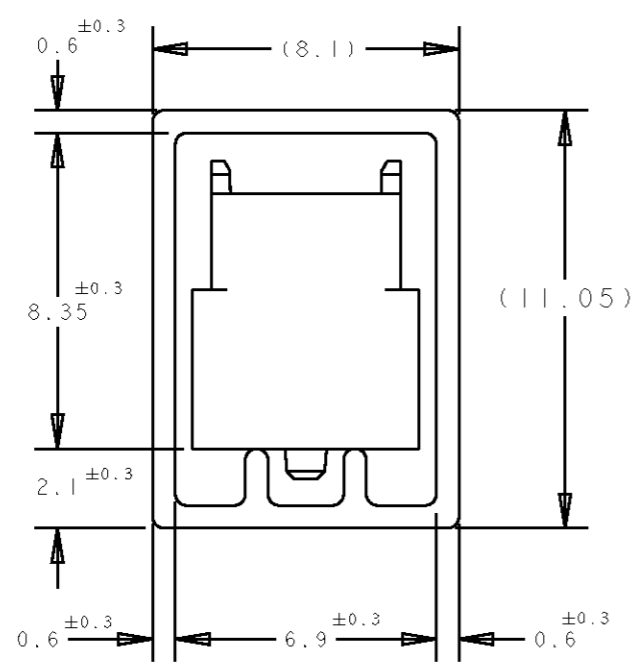

DETAIL "B"
(SCALE 5-1)

5 OBSOLETE	11	40.2	41.8	35.2	90	1-	-2
	14	32.2	33.8	27.2	70	1-	-1
	5	84.2	85.8	79.2	200	1-	-0
	6	76.2	77.8	71.2	180		-9
	6	68.2	69.8	63.2	160		-8
	7	60.2	61.8	55.2	140		-6
	9	52.2	53.8	47.2	120		-5
	10	44.2	45.8	39.2	100		-4
	12	36.2	37.8	31.2	80		-3
	16	28.2	29.8	23.2	60		-2
	22	20.2	21.8	15.2	40		5179031-1
QTY/ TUBE	C	B	A	POS.	CONN P/N		

DWN FLORENCE 28JUL04		STE TE Connectivity	
CHK ERIC TNG			
APVD SEIFONG		NAME	
PRODUCT SPEC 108-5390		PLUG ASSEMBLY 8H TYPE (0.5 BOSS LENGTH) FOR FH 0.8MM PITCH B-T-B CONNECTOR	
APPLICATION SPEC 114-5254		SIZE A3	CAGE CODE 00779
WEIGHT -		DRAWING NO C-5179031	
CUSTOMER DRAWING		SCALE 4:1	SHEET 2 OF 2 REV A4

DIMENSIONS: mm	TOLERANCES UNLESS OTHERWISE SPECIFIED:
	0 PLC ±-
	1 PLC ±0.30
	2 PLC ±0.25
	3 PLC ±0.20
	4 PLC ±-
	ANGLES ±3°
MATERIAL	FINISH

单击下面可查看定价，库存，交付和生命周期等信息

[>>TE Connectivity\(泰科\)](#)