

PART NUMBER	REV	FIRST USED	TYPE
2376800-1	B	-	NON CE
2376800-2	B	-	CE
1-2376800-3	B	-	NON CE,W/ AC
1-2376800-4	B	-	CE,W/ AC

REVISIONS					
P	LTR	DESCRIPTION	DATE	DWN	APVD
B1		ECR-24-197819	22JAN24	RRD	CZ
B2		ECR-24-216204	29JUL24	GK	BB

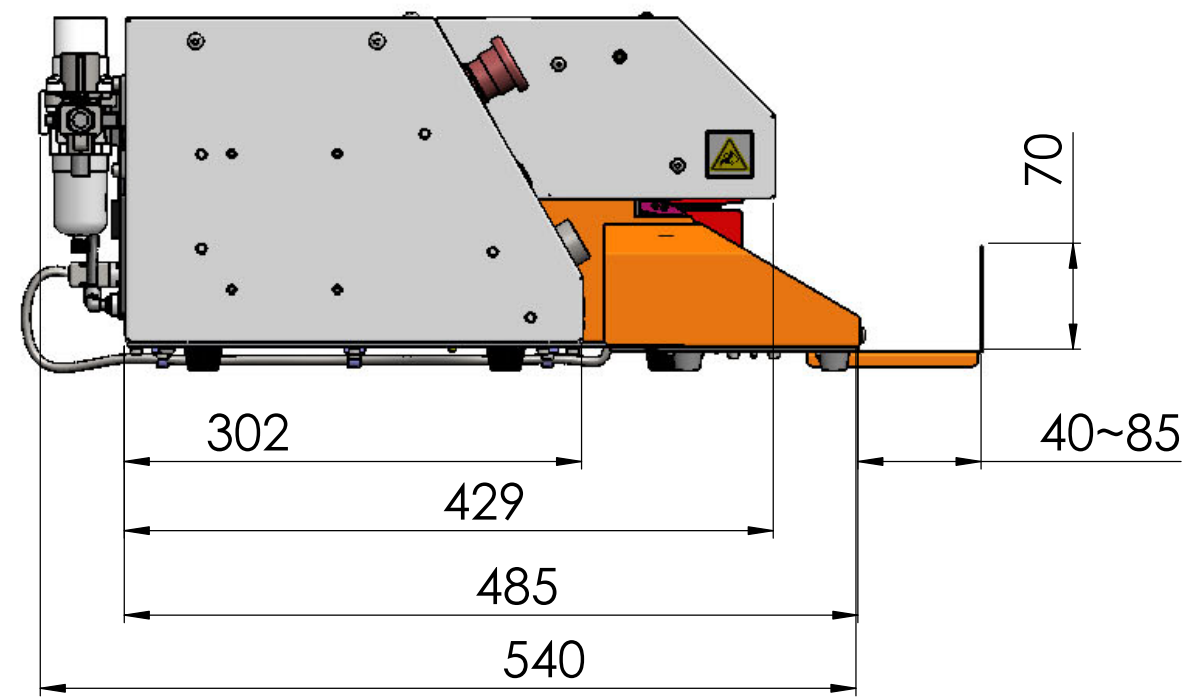

1. RECOMMENDED SPARE PARTS: NONE
2. IDENTIFY PART PER TEC-115-67-8.
3. TORQUE RECOMMENDATIONS PER 101-35000 UNLESS OTHERWISE SPECIFIED.
4. ALL DIMENSIONS ARE REFERENCE DIMENSIONS.

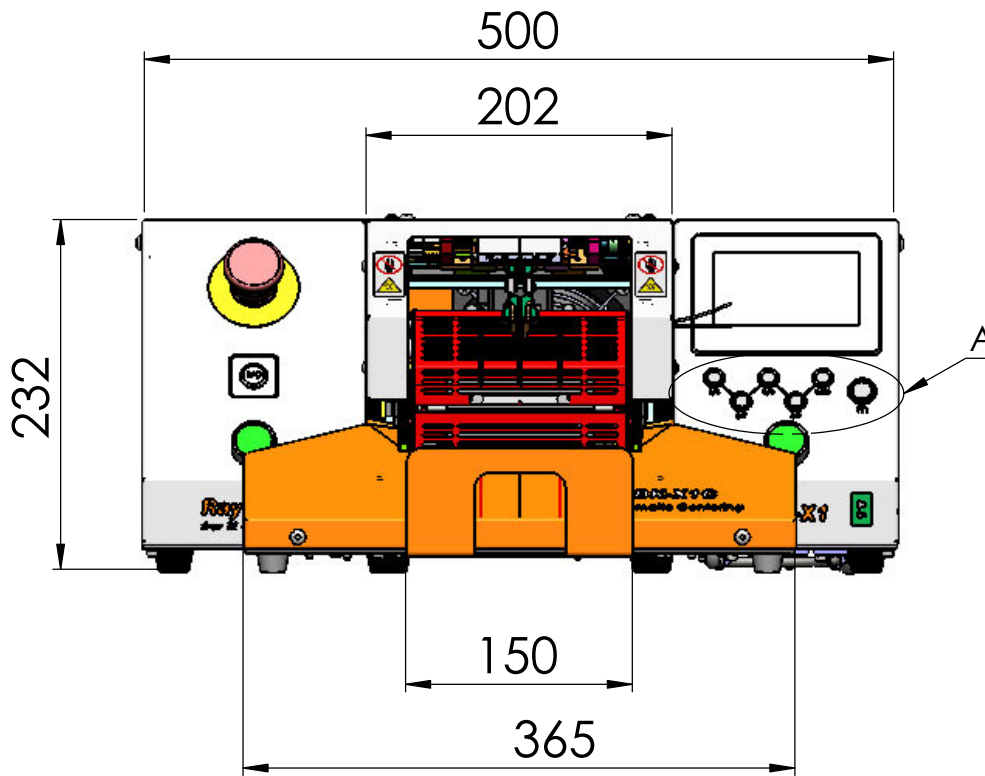
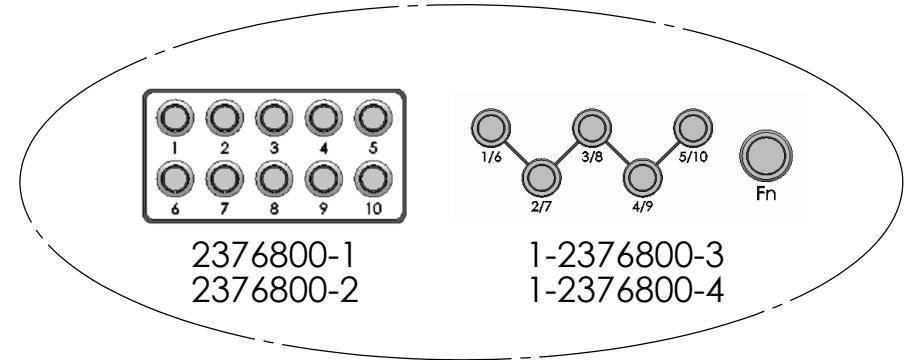
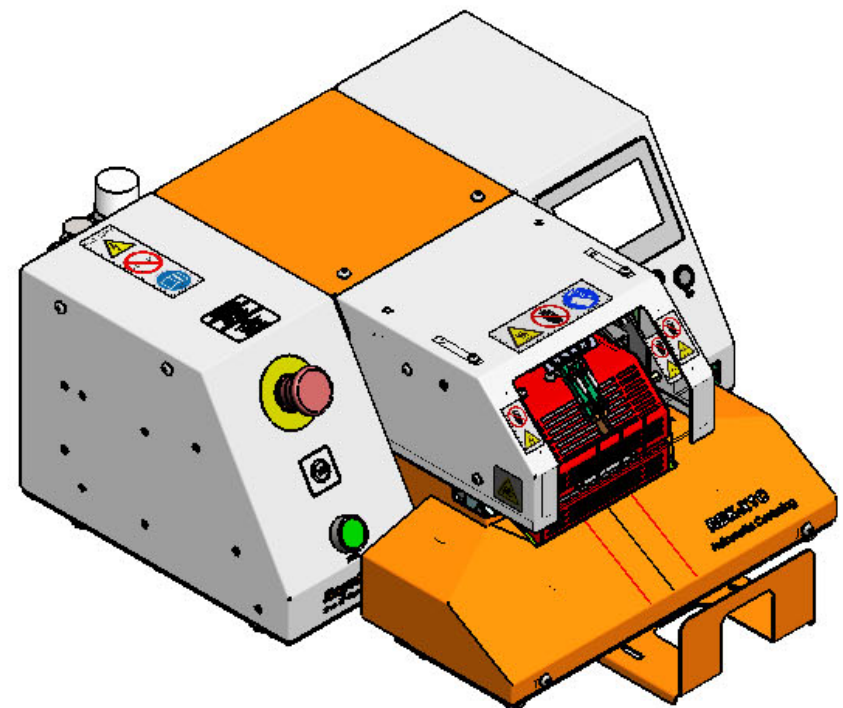

2376800-1  
2376800-2

1-2376800-3  
1-2376800-4

DETAIL A

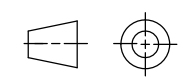
THIS DRAWING IS A CONTROLLED DOCUMENT.		DWN	C.ZHU	14DEC2023	 <b>TE Connectivity</b>					
DIMENSIONS: mm		CHK	C.ZHU	14DEC2023				NAME <b>RBK-X1C HEAT SHRINK MACHINE</b>		
		APVD	C.ZHU	14DEC2023						
TOLERANCES UNLESS OTHERWISE SPECIFIED:		PRODUCT SPEC			A3					
0 PLC ± -		SEE FIRST USED			C-2376800					
1 PLC ± -		APPLICATION SPEC			SCALE			1:5		
2 PLC ± -		-			SHEET			1 OF 4		
3 PLC ± -		WEIGHT			REV			B2		
4 PLC ± -		CUSTOMER DRAWING								
ANGLES ± -										
FINISH										
MATERIAL										

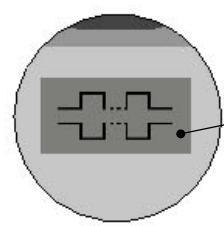
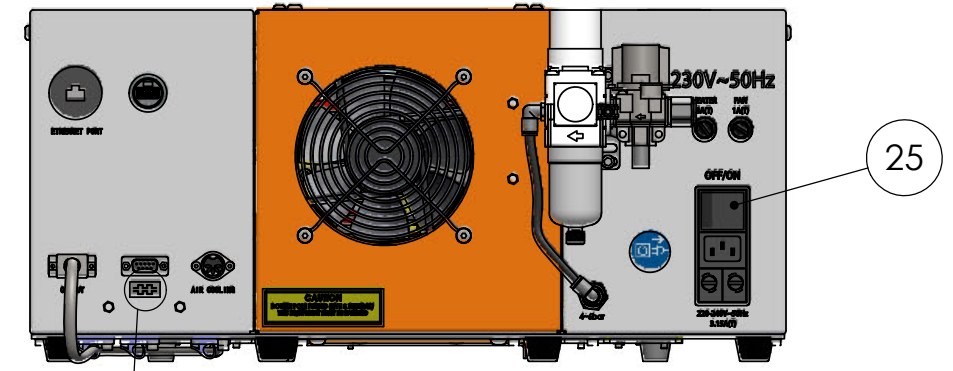
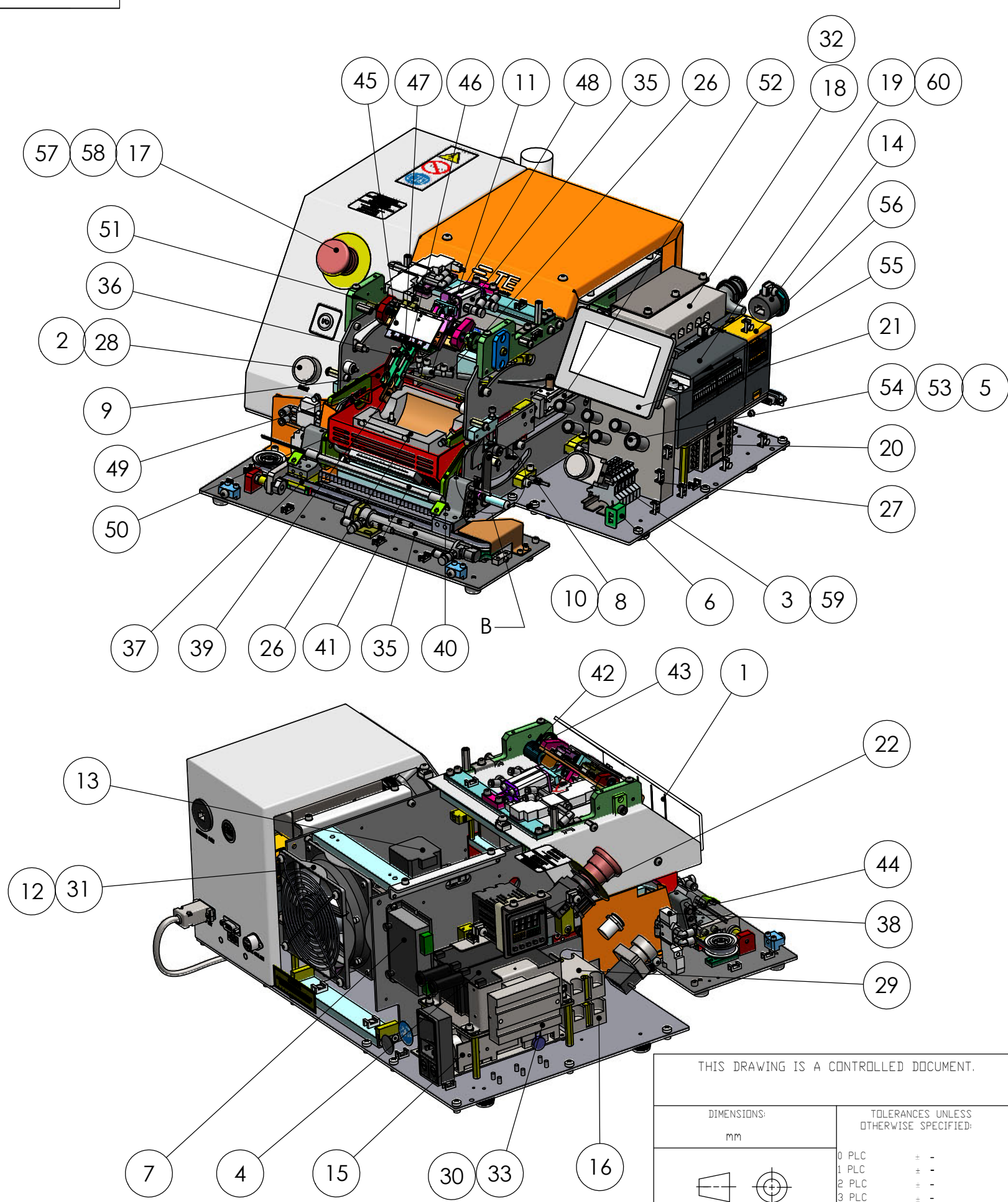

COMMUNICATION ADAPTER TAG

DETAIL C

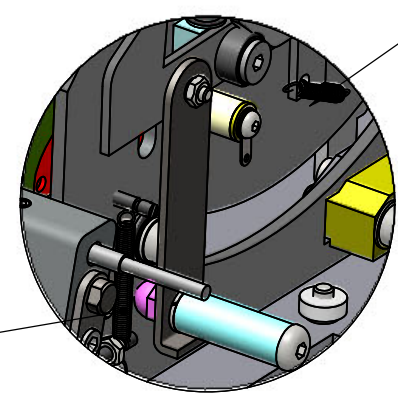

DETAIL B

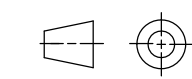
THIS DRAWING IS A CONTROLLED DOCUMENT.		DWN	C.ZHU	14DEC2023	 <b>TE Connectivity</b>
DIMENSIONS: mm		CHK	C.ZHU	14DEC2023	
TOLERANCES UNLESS OTHERWISE SPECIFIED:		APVD	C.ZHU	14DEC2023	
	0 PLC ± - 1 PLC ± - 2 PLC ± - 3 PLC ± - 4 PLC ± - ANGLES ± -	PRODUCT SPEC	SEE FIRST USED		NAME
MATERIAL	FINISH	APPLICATION SPEC	-		RBK-X1C HEAT SHRINK MACHINE
		WEIGHT	-		SIZE
		CUSTOMER DRAWING	A3		CAGE CODE
			SCALE 1:5		DRAWING NO
			SHEET 2 OF 4		RESTRICTED TO
			REV B2		

## SPARE PARTS LIST

ITEM NO	-1	-2	-13	-14	TE/PN	DESCRIPTION
1	1	1	1	1	2369602-1	VIEW WINDOW
2	2	-	2	-	2234980-1	START BUTTON(GREEN)
3	2	2	2	2	2234984-1	CONTACT BASE, STD
4	2	2	2	2	2234971-1	STORAGE BATTERY
5	10	10	10	10	2234981-1	PROCESS SLECTION BUTTON
6	1	1	1	1	2234973-1	THERMOCOUPLE PANEL SOCKET
7	1	1	1	1	2234972-1	MOTOR DRIVER
8	2	-	2	-	2234988-1	PROXIMITY SENSOR,STD
9	2	2	2	2	2-2369603-2	AUXILIARY PUSH PLATE
10	-	2	-	2	2234988-2	PROXIMITY SENSOR,CE
11	1	1	1	1	2234990-1	THERMOCOUPLE
12	1	-	1	-	2234963-1	COOLING FAN,220V
13	1	1	1	1	2234883-1	STEPPER MOTOR
14	1	1	1	1	2234887-1	PORT CONNECTOR
15	1	1	1	1	2234970-1	24V POWER SUPPLIER
16	1	1	1	1	2234969-1	SOLID STATE RELAY,STD
17	1	1	1	1	2234983-1	EMERGENCY STOP BUTTON HEAD
18	1	-	1	-	2234985-1	SWITCH,TP-LINK
19	1	1	-	-	2234964-1	CPU MODULE,PROGRAMMED
20	1	1	1	1	2234967-1	SAFETY REPLY
21	1	1	1	1	2234977-1	HUMAN MACHINE INTEFACE
22	1	1	1	1	2234968-1	TEMPERATURE CONTROLLER
23	2	2	2	2	2234868-1	RESET SPRING,LATCH ASSEMBLY
24	2	2	2	2	2234869-1	RESET SPRING,PINCH BLOCK
25	1	1	1	1	2234978-1	POWER SWITCH
26	1	1	1	1	2234991-1	HEATING ELEMENTS MOUDLE
27	-	1	-	1	2234967-2	TWO HANDED MOUDLE<FOR CE VERSION>
28	-	2	-	2	2234980-2	START BUTTON(WHITE)
29	1	2	1	2	2234969-2	SOLID STATE RELAY,CE
30	1	-	1	-	2234995-1	FILTER FUSE TERMINAL
31	-	1	-	1	2234963-2	COOLING FAN,24V
32	-	1	-	1	2234985-2	SWITCH,KORENIX
33	-	1	-	1	2234995-2	WAVE FILTER

THIS DRAWING IS A CONTROLLED DOCUMENT.		DWN	C.ZHU	14DEC2023	 TE Connectivity
		CHK	C.ZHU	14DEC2023	
		APVD	C.ZHU	14DEC2023	
		PRODUCT SPEC	SEE FIRST USED		
		APPLICATION SPEC	-		NAME
		RBK-X1C HEAT SHRINK MACHINE			
		SIZE	CAGE CODE	DRAWING NO	RESTRICTED TO
		A3		C-2376800	-
		WEIGHT	-		
		CUSTOMER DRAWING			SCALE
					1:5
					SHEET
					3 OF 4
					REV
					B2

DIMENSIONS: mm	TOLERANCES UNLESS OTHERWISE SPECIFIED:
	0 PLC ± - 1 PLC ± - 2 PLC ± - 3 PLC ± - 4 PLC ± - ANGLES ± -
MATERIAL	FINISH
-	-

### SPARE PARTS LIST (CENTERING DEVICE)

ITEM NO	-1	-2	-13	-14	TE/PN	DESCRIPTION
34	1	1	1	1	4-2369604-5	CYLINDER,DETECTION UNIT
35	1	1	1	1	6-2369604-7	CYLINDER,CENTERING UNIT
36	2	2	2	2	5-2369604-8	SPRING,DETECTION UNIT
37	1	1	1	1	9-2369604-9	TIMING BELT
38	2	2	2	2	4-2369604-2	SPRING,SWING PIIECE
39	1	1	1	1	3-2369602-1	DETECT PIECE
40	1	1	1	1	3-2369602-7	PLATE OF CENTER
41	1	1	1	1	3-2369604-5	LIGHT
42	1	1	1	1	7-2369602-1	MAIN DRIVE GEAR
43	1	1	1	1	5-2369602-7	DRIVEN GEAR
44	1	1	1	1	2-2369604-5	SENSOR,CENTER OFTUBE
45	1	1	1	1	8-2369602-5	MARK PLATE
46	2	2	2	2	2-2369603-4	POINTER
47	1	1	1	1	3-2369604-6	CALIBRATION LABEL
48	4	4	4	4	5-2369604-6	SENSOR,CYLINDER
49	1	1	1	1	5-2369602-2	DETECT PIECE<SEE 3-2369602-1>
50	1	1	1	1	9-2369602-4	PLATE OF CENTER<SEE 3-2369602-7>
51	1	1	1	1	3-2459377-5	O-RING
52	-	-	2	2	9-2369604-8	CYLINDER,PUSHING UNIT
53	-	-	5	5	1-2234981-1	PROCESS SLECTION BUTTON
54	-	-	1	1	1-2234981-2	FUNCTION SWITCH BUTTON
55	1	1	1	1	2234965-1	COMMUNICATION MODULE
56	1	1	1	1	2234966-1	ANALOG INPUT MODULE
57	1	1	1	1	2234983-2	EMERGENCY STOP BUTTON LEBAL
58	1	1	1	1	2234983-3	EMERGENCY STOP BUTTON BASE
59	-	2	-	2	2234984-2	CONTACT BASE, CE
60	-	-	1	1	2234964-2	CPU MODULE,PROGRAMMED, W/AC

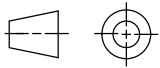
THIS DRAWING IS A CONTROLLED DOCUMENT.		DWN	C.ZHU	14DEC2023	 <b>TE Connectivity</b>
DIMENSIONS: mm		CHK	C.ZHU	14DEC2023	
		APVD	C.ZHU	14DEC2023	
TOLERANCES UNLESS OTHERWISE SPECIFIED:		PRODUCT SPEC		NAME	
0 PLC ± -		SEE FIRST USED		RBK-X1C HEAT SHRINK MACHINE	
1 PLC ± -		APPLICATION SPEC		SIZE	
2 PLC ± -		-		CAGE CODE	
3 PLC ± -		WEIGHT		DRAWING NO	
4 PLC ± -		-		RESTRICTED TO	
ANGLES ± -		-		-	
MATERIAL		-		A3	
FINISH		-		C= 2376800	
-		-		SCALE 1:5	
-		-		SHEET 4 OF 4	
-		-		REV B2	
-		-		CUSTOMER DRAWING	

单击下面可查看定价，库存，交付和生命周期等信息

[>>TE Connectivity\(泰科\)](#)