

# AMPMODU Interconnection System

RoHS  
Ready 



## Table of Contents

<b>PC/104 and PC/104-Plus Connectors</b> <span style="font-size: 2em; font-weight: bold;">1</span>	<b>1 PC/104 and PC/104-Plus Connectors</b> Introduction .....5 PC/104, Press Fit .....6, 7 PC/104-Plus, Press Fit .....8, 9 PC/104, Solder .....10 PC/104-Plus, Solder .....11 Accessories, Kits .....12
<b>.050 x .050 [1.27 x 1.27] Centerline</b> <span style="font-size: 2em; font-weight: bold;">2</span>	<b>2 0.050 [1.27] x 0.050 [1.27] CENTERLINE          AMPMODU 50/50 Grid</b> <b>Board-to-Board Vertical Receptacles and Headers:</b> Introduction .....13, 14 Vertical Receptacles, Double Row .....15 Vertical Headers, Double Row .....16 Recommended PC Board Layouts .....17 <b>Board-to-Board Right-Angle Headers:</b> Introduction .....18 Right-Angle Headers, Double Row, Latching and Non-Latching .....19 <b>Cable-to-Board Connectors:</b> Introduction .....20 Receptacle Connectors, Double Row, With and Without Latch .....21 Cable Connector Terminating Cover, Double Row .....22 IDC (Insulation Displacement Crimp) Tooling .....23 <b>Performance Specifications</b> .....24 <b>Technical Documents</b> .....24
<b>.050 x .100 [1.27 x 2.54] Centerline</b> <span style="font-size: 2em; font-weight: bold;">3</span>	<b>3 .050 [1.27] x 0.100 [2.54] CENTERLINE          AMPMODU System 50</b> <b>Board-to-Board Connectors, Thru-Hole:</b> Introduction .....26 Headers, Shrouded and Unshrouded .....27-35 Introduction .....36 Receptacles .....37-40 PC Board Hole Layouts .....41, 42 <b>Board-to-Board Connectors, Surface-Mount:</b> Introduction .....43 Headers .....44 Receptacles .....45 <b>Cable-to-Board Connectors, FFC Cable:</b> Introduction .....46 Flexible Flat Conductor Cable .....47 FFC Contacts .....48 Receptacle Housings .....49-52 ZIF-Line Connectors .....53, 54 <b>Cable-to-Board Connectors, Ribbon Cable:</b> Introduction .....55 Ribbon Cable Receptacles .....56 Paddleboard Receptacles .....57 Flat Ribbon Cable .....58, 59 Application Tooling for Flex Film Contacts .....60 <b>Application Tooling</b> .....60-62 <b>Performance Specifications</b> .....63 <b>Technical Documents</b> .....64
<b>AMPMODU 2mm Connectors</b> <span style="font-size: 2em; font-weight: bold;">4</span>	
<b>.100 x .100 [2.54 x 2.54] Centerline</b> <span style="font-size: 2em; font-weight: bold;">5</span>	
<b>.125 x .125 [3.18 x 3.18] Centerline</b> <span style="font-size: 2em; font-weight: bold;">6</span>	
<b>.156 [3.96] Centerline</b> <span style="font-size: 2em; font-weight: bold;">7</span>	
<b>Shunts</b> <span style="font-size: 2em; font-weight: bold;">8</span>	

**Table of Contents** (Continued)

<b>4</b>	<b>AMPMODU 2mm Connectors</b>	
	AMPMODU 2mm Connectors (Board to Board)	65
	Headers, Unshrouded, Double Row, Thru-Hole Mount	66, 67
	Breakaway Headers, Unshrouded, Double Row, Thru-Hole Mount	68-70
	Breakaway Headers, Unshrouded, Double Row, Surface Mount	71, 72
	Stacking Header, Unshrouded, Double Row, Thru-Hole Mount	73
	Headers, Shrouded, Double Row, Thru-Hole, Right-Angle Mount	74, 75
	Headers, Shrouded, Double Row, Surface Mount	76, 77
	Headers, Shrouded, Double Row, Thru-Hole Mount with Cable Shrouds	78, 79
	Receptacles, Double Row, Thru-Hole, Vertical Mount	80, 81
	Receptacles, Double Row, Surface Mount, Right-Angle Mount	82
	Receptacles, Double Row, Thru-Hole, Right-Angle Mount	83
	Receptacles, Double Row, Surface Mount, Vertical Mount	84
<b>5</b>	<b>.100 [2.54] x .100 [2.54] CENTERLINE</b>	
	Introduction	85-87
	Terms Explained	87
	Wire Sizes	88
	Contact Platings	88
	Mating Post Lengths	88
	Application Tooling	88
	Board-to-Board Solutions Guides, .100[2.54] Centerline Products	89
	Wire-to-Board Solutions Guide, .100[2.54] Centerline Products	89
	Mating Post Selection Guide	90
	Parallel Stacking Guide for Board-to-Board Applications	91
	<b>Board-to-Board Products:</b>	
	Unshrouded Headers	92-100
	Breakaway and Retention Headers-Unshrouded	101-105
	Reeled Breakaway Headers	106, 107
	Surface Mount Breakaway Headers	108-110
	Unshrouded Stacking Headers- Breakaway	111-113
	Shrouded Headers	114-140
	Standard Profile	114-133
	Low Profile	134-140
	Shrouded Stacking Headers	141-144
	ACTION PIN Headers	145-149
	ACTION PIN Press-Fit Posts	150, 151
	Application Tooling for ACTION PIN Posts	152, 153
	ACTION PIN Stacking Connectors	154-161
	Application Tooling for AMP ACTION PIN Stacking Connectors	162
	0.025 [0.64] Square Posts	163
	0.025 [0.64] Square Continuous Posts	164, 165
	0.045 [1.14] Square Continuous Posts	166, 167
	Horizontal Mount Receptacle Assemblies, Mod II	168-173
	Vertical Mount Receptacle Assemblies, Mod II & Mod IV	174-184
	Surface Mount Vertical Receptacles, Mod IV	185-192
	Two-Piece Printed Circuit Board Connectors	193-202
	Accessories	203-205
	<b>Wire-to-Board Products:</b>	
	Locking Clip Contacts and Housings	206-209
	Mod IV Contacts and Housings	210-220
	Short Point Contacts and Housings	221-224
	MTE Interconnection System	225-250
	Surface Mount MTE Headers (Right-Angle & Vertical)	251, 252
	Interchangeable Contacts, Wire Crimp (Snap-In)	253, 254
	MT and Shielded MT Connectors	255-265
	Mini-Tandem Spring Receptacle Contacts	266-269
	<b>Application Tooling</b>	270-275
	<b>Technical Documents</b>	276-278

<b>1</b>	PC/104 and PC/104-Plus Connectors
<b>2</b>	.050 x .050 [1.27 x 1.27] Centerline
<b>3</b>	.050 x .100 [1.27 x 2.54] Centerline
<b>4</b>	AMPMODU 2mm Connectors
<b>5</b>	.100 x .100 [2.54 x 2.54] Centerline
<b>6</b>	.125 x .125 [3.18 x 3.18] Centerline
<b>7</b>	.156 [3.96] Centerline
<b>8</b>	Shunts

**Table of Contents** (Continued)

PC/104 and PC/104-Plus Connectors  
**1**

.050 x .050 [1.27 x 1.27] Centerline  
**2**

.050 x .100 [1.27 x 2.54] Centerline  
**3**

AMPMODU 2mm Connectors  
**4**

.100 x .100 [2.54 x 2.54] Centerline  
**5**

.125 x .125 [3.18 x 3.18] Centerline  
**6**

.156 [3.96] Centerline  
**7**

Shunts  
**8**

**6** .125 [3.18] x .125 [3.18] CENTERLINE  
Wire-to-Board Product:  
Level V IDC Connectors .....279-282

**7** .156 [3.96] CENTERLINE  
Mod I 0.031 x 0.062 Interconnection System  
Introduction .....283, 284  
Receptacles, Vertical and Horizontal Board Mount .....285, 286  
Receptacle Assemblies, Vertical and Horizontal Board Mount .....287-289  
Receptacles, Crimp Snap-In (Wire Applied) .....290  
Receptacle Housings, Standard Profile-Unkeyed (With/Without Strain Relief) ...291, 292  
Receptacle Housings, Low Profile-Keyed .....293  
Posts, Machined Applied .....294  
Headers:  
Straight Post, Keyed .....295, 296  
Right-Angle, Keyed .....297  
Locking Clip Contacts, Crimp Snap-In (Wire Applied) .....298  
Locking Clip Connector Housings, Single Row, Crimp Snap-In .....299  
Application Tooling .....300-304  
Performance Specifications .....305  
Technical Documents .....305

**8** Shunts  
Dual In-Line Package DIP Shunts .....306, 307  
Post Shunts .....308-310  
Performance Specifications .....311  
Technical Documents .....311  
Part Number Index .....313-316

**Restriction on the use of Hazardous Substances (RoHS)**

At TE Connectivity (TE), we're ready to support your RoHS requirements. We've assessed more than 1.5 million end items/components for RoHS compliance, and issued new part numbers where any change was required to eliminate the restricted materials. Part numbers in this catalog are identified as:

**RoHS Compliant** — Part numbers in this catalog are RoHS Compliant, unless marked otherwise. These products comply with European Union Directive 2002/95/EC as amended 1 January 2006 that restricts the use of lead, mercury, cadmium, hexavalent chromium, PBB, and PBDE in certain electrical and electronic products sold into the EU as of 1 July 2006.

NOTE: For purposes of this catalog, included within the definition of RoHS Compliant are products that are clearly "Out of Scope" of the RoHS Directive such as hand tools and other non-electrical accessories.

NOTE: Information regarding RoHS compliance is provided based on reasonable inquiry of our suppliers and represents our current actual knowledge based on the information provided by our suppliers. This information is subject to change. For latest compliance status, refer to our website referenced at right.

**Getting the Information You Need**

Our comprehensive on-line RoHS Customer Support Center provides a forum to answer your questions and support your RoHS needs. A RoHS FAQ (Frequently Asked Questions) is available with links to more detailed information. You can also submit RoHS questions and receive a response within 24 hours during a normal work week. The Support Center also provides:

- Cross-Reference from Non-compliant to Compliant Products
- Ability to browse RoHS Compliant Products in our on-line catalog
- Downloadable Technical Data Customer Information Presentation
- More detailed information regarding the definitions used above
- So whatever your questions when it comes to RoHS, we have the answers at [www.te.com/leadfree](http://www.te.com/leadfree)



## PC/104 and PC/104-Plus Connectors

### Product Facts

- Press fit design — eliminates hand soldering
- Unitized PC/104 connector assembly — eliminates two piece (64 pin & 40 pin) configuration
- Integral board spacers with captive hardware — eases & improves assembly efficiency while minimizing stocked hardware
- “Flat-rock” insertable — no need for complex insertion tooling
- Recognized by Underwriters' Laboratories to US and Canadian standards  file No. E28476
- Fully compliant with PC104 & PC104-Plus standards
- Solutions available for lead free processes (ie. ENIG and silver immersion plated PCB's)

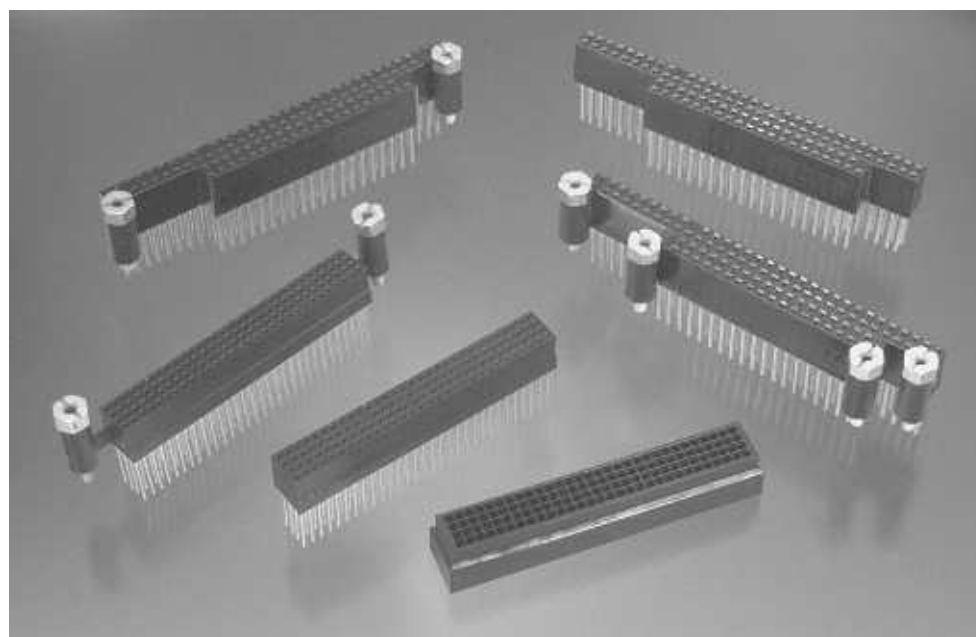
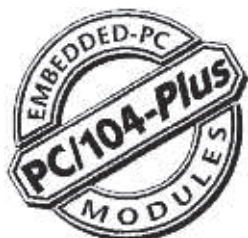

The PC/104 and PC/104-Plus connectors are industry standard product offerings which comply with the interconnection requirements defined by the PC/104 organization (<http://www.pc104.org>)

Both products are designed specifically for “flat-rock” press-fit installation for ease of application. Solder version is also available.

Optional integral standoffs minimize the customer's system assembly time.

The TE offering of the standard PC/104 product is a unitized connector rather than the two piece, 40 and 64 position connectors currently on the market. Customer needs to stock and apply only one part number rather than two.

### Performance Specifications

#### Electrical Characteristics

Meets requirements of PC/104 and PC/104-Plus standards

**Nominal Resistance** — 10 milliohms maximum,  $\Delta R$

**Insulation Resistance** — 1000 megohms minimum

**Dielectric Withstanding Voltage** — 500 VAC for 1 min. at sea level

#### Mechanical Characteristics

Meets requirements of PC/104 and PC/104-Plus standards

**Current** — Signal application only

**Temperature** — -55° to 105°C

#### Material and Finish

**Housing** — Black Thermoplastic, UL 94V-0

**Contact** — Phosphor Bronze, Full Gold all over Nickel (stackthrough), Gold on mating end, Tin or Tin-lead on PCB tail all over Nickel (non-stackthrough)

### Need more information?

Call Technical Support 1-800-522-6752:

Technical Support is staffed with specialists well versed in all TE products. The Center can provide you with:

- Technical Support
- Catalogs
- Technical Documents
- TE Authorized Distributor Locations

### Technical Documents

#### Product Specifications

108-1956

#### Application Specifications

114-13021

Connector	Centerline	Position
PC/104	.100 2.54	104*
PC/104-Plus	.079 2.0	120**

\*Two circuits plugged per PC/104 specification. Other options available.

\*\*One circuit plugged per PC/104-Plus specification. Other options available.

## PC/104, Press-Fit

### Material and Finish

**Housing** — Glass filled thermoplastic, Black, 94V-0 rated

### Contacts

**Stackthrough** — Phosphor Bronze; plated .000015 [0.00038] min. Gold on mating receptacle end, .000005 [0.000130] min. Gold on remainder, all over .000050 [0.00127] Nickel

or  
Phosphor Bronze; plated .000015 [0.00038] min. Gold on mating receptacle end, .000100-.000200 [0.00254-.00508] matte tin on compliant section, .000005 [0.000130] min. Gold on remainder of post, all over .000050 [0.00127] Nickel

**Non-Stackthrough** — Phosphor Bronze; plated .000015 [0.00038] min. Gold on mating receptacle end, .000100 [0.00254] matte tin or tin-lead on remainder, all over .000050 [0.00127] Nickel

**Screwlocks** — Steel, Clear Chromate over Zinc

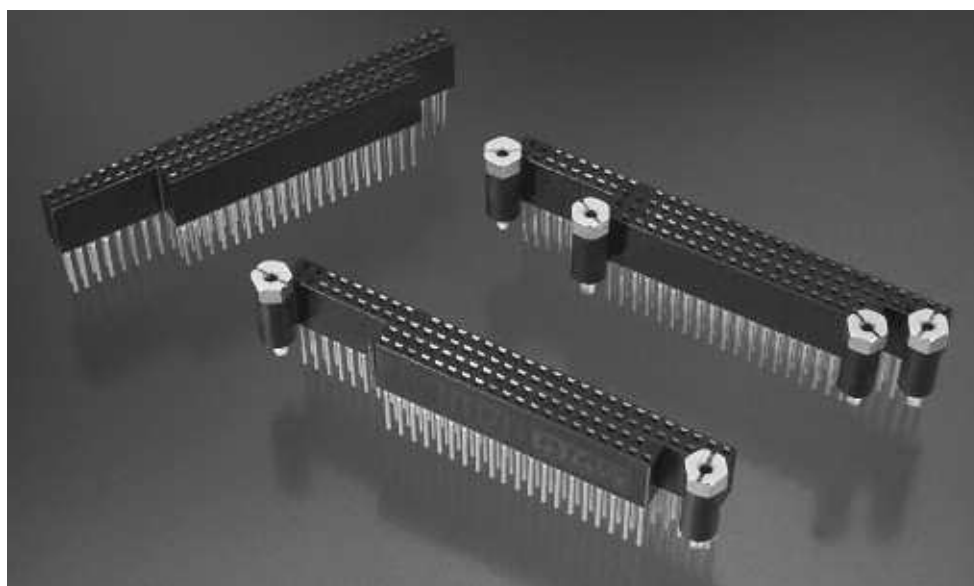

### Stackthrough, No Standoffs

Gold plated contacts\*

**Part No. 1375795-1** (keyed), **Part No. 1375795-2** (unkeyed)

Gold plated contacts with Tin plated compliant pin section\*\*

**Part No. 1375795-3** (keyed), **Part No. 1375795-4** (unkeyed)

### Non-Stackthrough, No Standoffs

Tin-lead plated tails\*

**Part No. 1375796-1** (keyed), **Part No. 1375796-2** (unkeyed)

Matte tin plated tails\*\*

**Part No. 1375796-3** (keyed), **Part No. 1375796-4** (unkeyed)

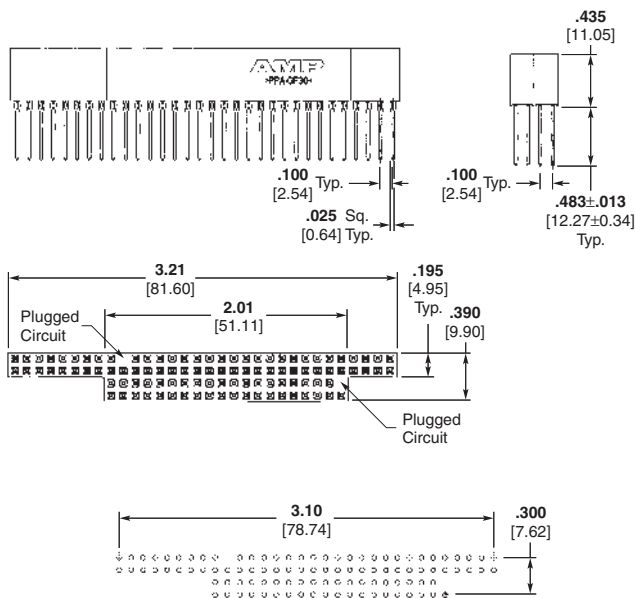

Keyed

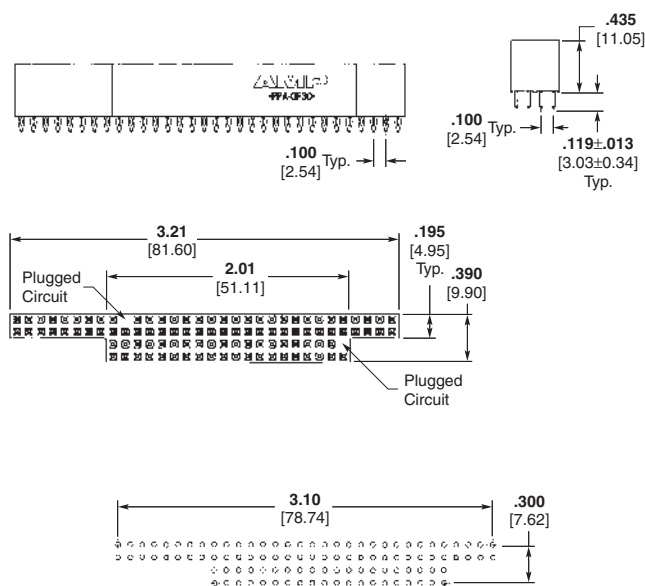

Unkeyed

**Recommended PC Board Layout**  
See Customer Drawing for  
Hole Geometry and Recommended Plating.

**Note:** All part numbers are RoHS compliant.

\* For RoHS exempt Tin-lead processes (including ENIG Plated PCB's)

\*\* for Silver Immersion processes or where a total lead free solution is desired

**PC/104, Press-Fit (Continued)**

**Stackthrough, 2 Standoffs**

Gold plated contacts\*

Part No. 1375793-1 (keyed), Part No. 1375793-2 (unkeyed)

Gold plated contacts with Tin plated compliant pin section\*\*

Part No. 1375793-3 (keyed), Part No. 1375793-4 (unkeyed)

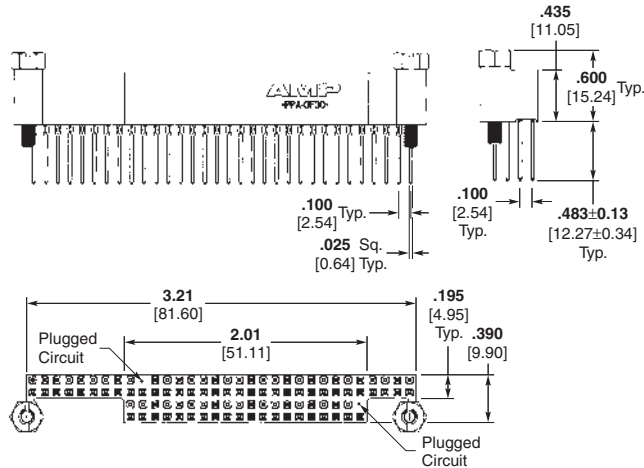

**Non-Stackthrough, 2 Standoffs**

Tin-lead plated tails\*

Part No. 1375794-1 (keyed), Part No. 1375794-2 (unkeyed)

Matte tin plated tails\*\*

Part No. 1375794-3 (keyed), Part No. 1375794-4 (unkeyed)

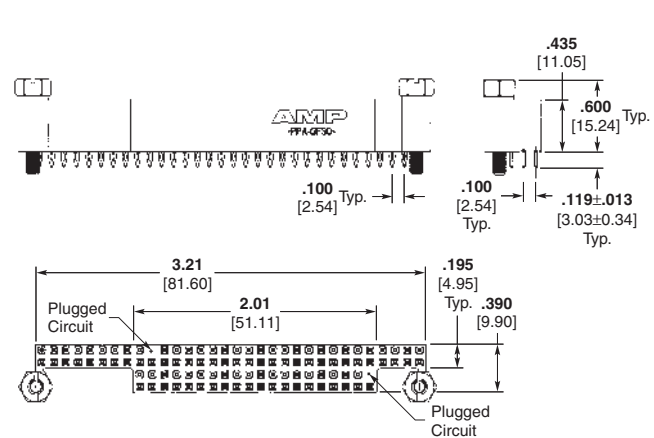

**Stackthrough, 4 Standoffs**

Gold plated contacts\*

Part No. 1375791-1 (keyed), Part No. 1375791-2 (unkeyed)

Gold plated contacts with Tin plated compliant pin section\*\*

Part No. 1375791-3 (keyed), Part No. 1375791-4 (unkeyed)

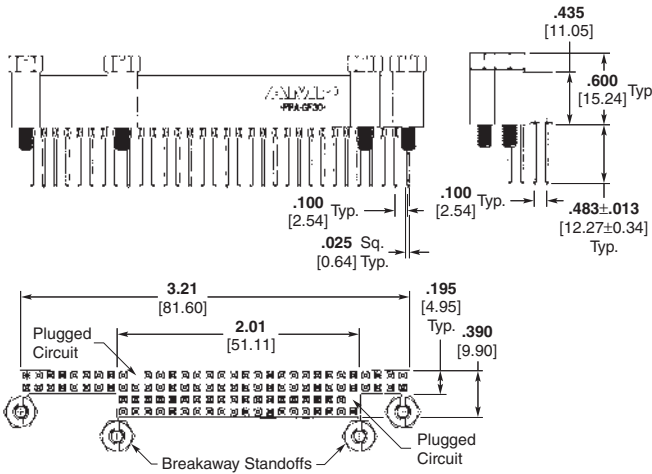

**Non-Stackthrough, 4 Standoffs**

Tin-lead plated tails\*

Part No. 1375792-1 (keyed), Part No. 1375792-2 (unkeyed)

Matte tin plated tails\*\*

Part No. 1375792-3 (keyed), Part No. 1375792-4 (unkeyed)

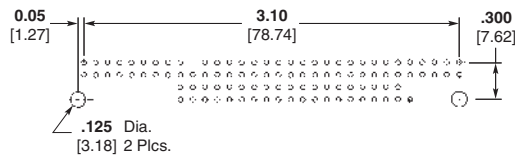
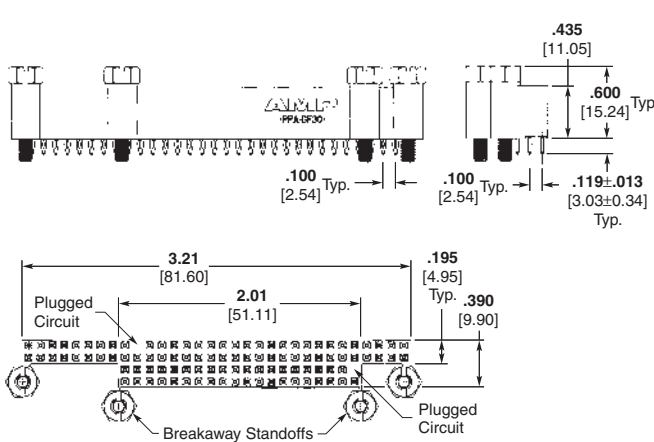

Keyed

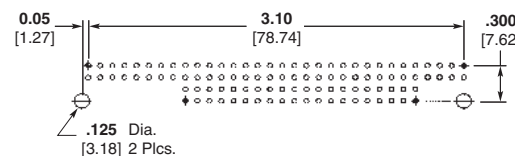

Unkeyed

**Recommended PC Board Layout**  
See Customer Drawing for  
Hole Geometry and Recommended Plating.

**Note:** All part numbers are RoHS compliant.

\* For RoHS exempt Tin-lead processes (including ENIG Plated PCB's)

\*\* for Silver Immersion processes or where a total lead free solution is desired

## PC/104-Plus, Press-Fit

### Material and Finish

**Housing** — Glass filled thermoplastic, Black, 94V-0 rated

### Contacts

**Stackthrough** — Phosphor Bronze; plated .000015 [0.00038] min. Gold on mating receptacle end, .000005 [0.000130] min. Gold on remainder, all over .000050 [0.00127] Nickel

or  
Phosphor Bronze; plated .000015 [0.00038] min. Gold on mating receptacle end, .000100-.000200 [0.000254-.00508] matte tin on compliant section, .000005 [0.000130] min. Gold on remainder of post, all over .000050 [0.00127] Nickel

**Non-Stackthrough** — Phosphor Bronze; plated .000015 [0.00038] min. Gold on mating receptacle end, .000100 [0.00254] matte tin or tin-lead on remainder, all over .000050 [0.00127] Nickel

**Screwlocks** — Steel, Clear Chromate over Zinc

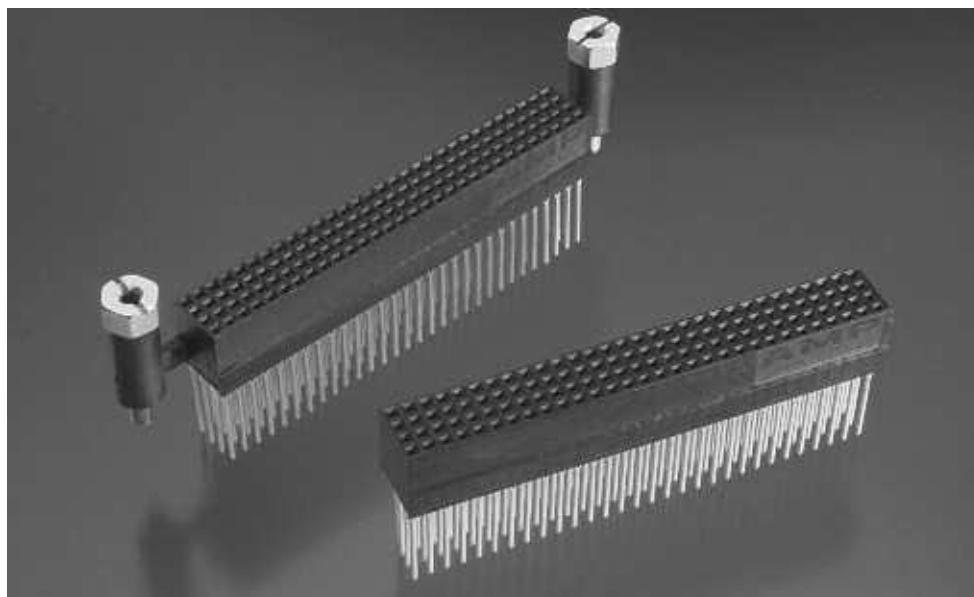

### Stackthrough, No Standoffs

Gold plated contacts\*

- Part No. 1375799-1 (unkeyed)
- Part No. 1375799-2 (keyed-A1) per PC/104-Plus specification
- Part No. 1375799-3 (keyed-D30) per PC/104-Plus specification

Gold plated contacts with Tin plated compliant pin section\*\*

- Part No. 1375799-4 (unkeyed)
- Part No. 1375799-5 (keyed-A1) per PC/104-Plus specification
- Part No. 1375799-6 (keyed-D30) per PC/104-Plus specification

### Non-Stackthrough, No Standoffs

Tin-lead plated tails\*

- Part No. 1375800-1 (unkeyed)
- Part No. 1375800-2 (keyed-A1) per PC/104-Plus specification
- Part No. 1375800-3 (keyed-D30) per PC/104-Plus specification

Matte tin plated tails\*\*

- Part No. 1375800-4 (unkeyed)
- Part No. 1375800-5 (keyed-A1) per PC/104-Plus specification
- Part No. 1375800-6 (keyed-D30) per PC/104-Plus specification

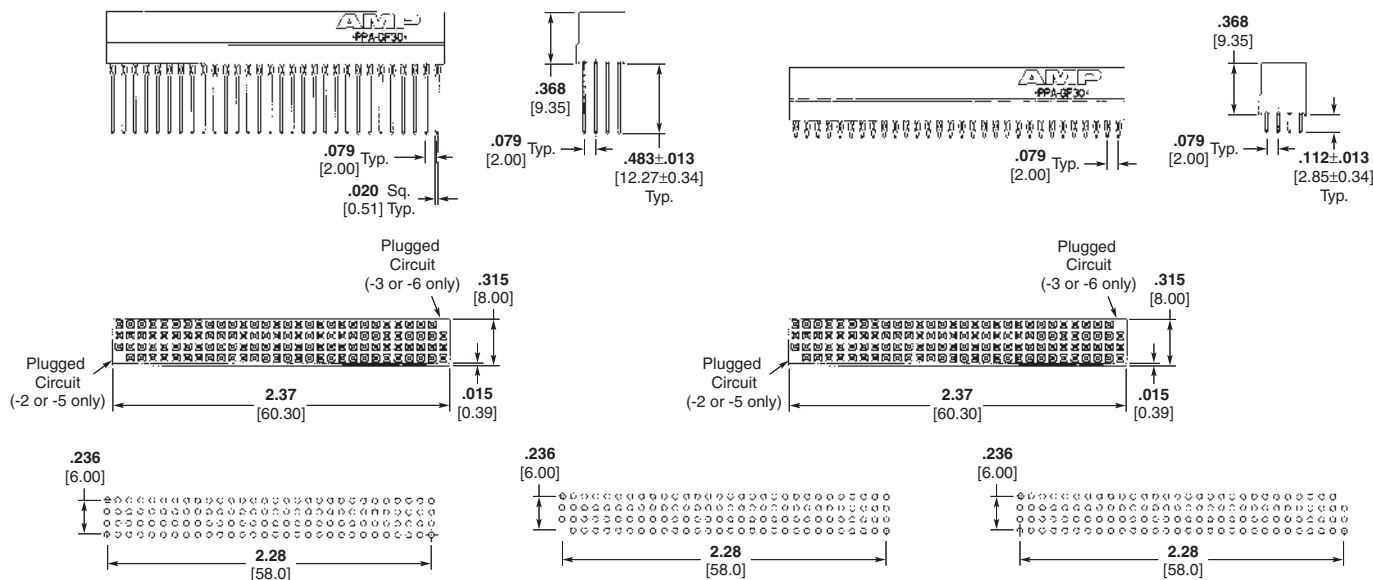

Recommended PC Board Layout for 1375799-1, 1375799-4, 1375800-1, 1375800-4

Recommended PC Board Layout for 1375799-2, 1375799-5, 1375800-2, 1375800-5

Recommended PC Board Layout for 1375799-3, 1375799-6, 1375800-3, 1375800-6

See Customer Drawing for Hole Geometry and Recommended Plating. (Including ENIG plated PCB's)

**Note:** All part numbers are RoHS compliant.

\* For RoHS exempt Tin-lead processes (including ENIG Plated PCB's)

\*\* for Silver Immersion processes or where a total lead free solution is desired



**PC/104-Plus, Press-Fit** (Continued)

**Non-Stackthrough, 2 Standoffs**

- Tin-lead plated tails\*
  - Part No. 1375798-1 (unkeyed)
  - Part No. 1375798-2 (keyed-A1) per PC/104-Plus specification
  - Part No. 1375798-3 (keyed-D30) per PC/104-Plus specification

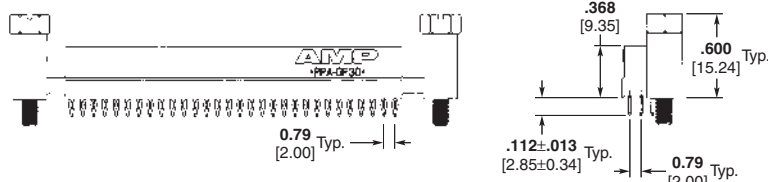

Matte tin plated tails\*\*

- Part No. 1375798-4 (unkeyed),
- Part No. 1375798-5 (keyed-A1) per PC/104-Plus specification
- Part No. 1375798-6 (keyed-D30) per PC/104-Plus specification

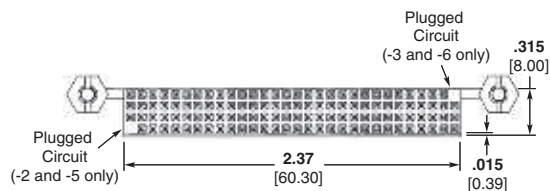

**Stackthrough, 2 Standoffs**

- Gold plated contacts\*
  - Part No. 1375797-1 (unkeyed)
  - Part No. 1375797-2 (keyed-A1) per PC/104-Plus specification
  - Part No. 1375797-3 (keyed-D30) per PC/104-Plus specification

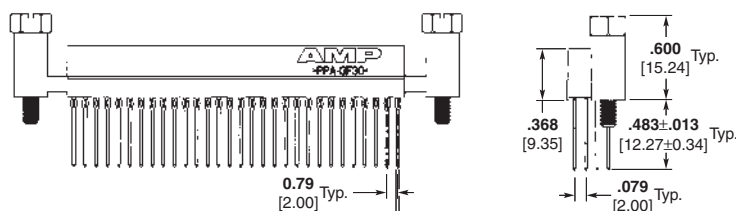

Gold plated contacts with Tin plated compliant pin section\*\*

- Part No. 1375797-4 (unkeyed)
- Part No. 1375797-5 (keyed-A1) per PC/104-Plus specification
- Part No. 1375797-6 (keyed-D30) per PC/104-Plus specification

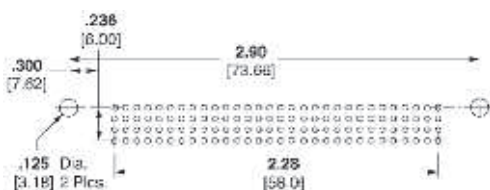
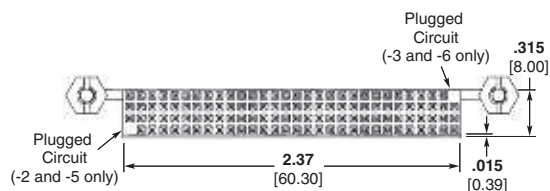

Recommended PC Board Layout for 1375797-1, 1375797-4, 1375798-1, 1375798-4

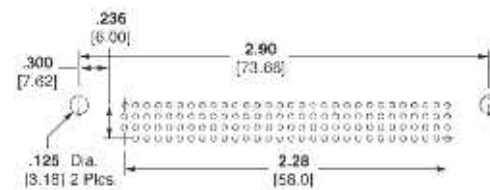

Recommended PC Board Layout for 1375797-2, 1375797-5, 1375798-2, 1375798-5

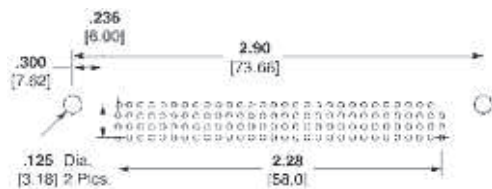

Recommended PC Board Layout for 1375797-3, 1375797-6, 1375798-3, 1375798-6

See Customer Drawing for Hole Geometry and Recommended Plating.

Note: All part numbers are RoHS compliant.

\* For RoHS exempt Tin-lead processes (including ENIG Plated PCB's)

\*\* for Silver Immersion processes or where a total lead free solution is desired

### PC/104, Solder

**Material and Finish**

**Housing** — Glass filled thermoplastic, Black, 94V-0 rated

**Contacts**

**Non-Stackthrough** — Phosphor Bronze; plated .000015 [0.00038] min. Gold on mating receptacle end, .000100 [0.00254] matte tin on remainder, all over .000050 [0.00127] Nickel

**Screwlocks** — Steel, Clear Chromate over Zinc

**Non-Stackthrough, No Standoffs**

**Part No. 1375963-3** (keyed)  
**Part No. 1375963-4** (unkeyed)

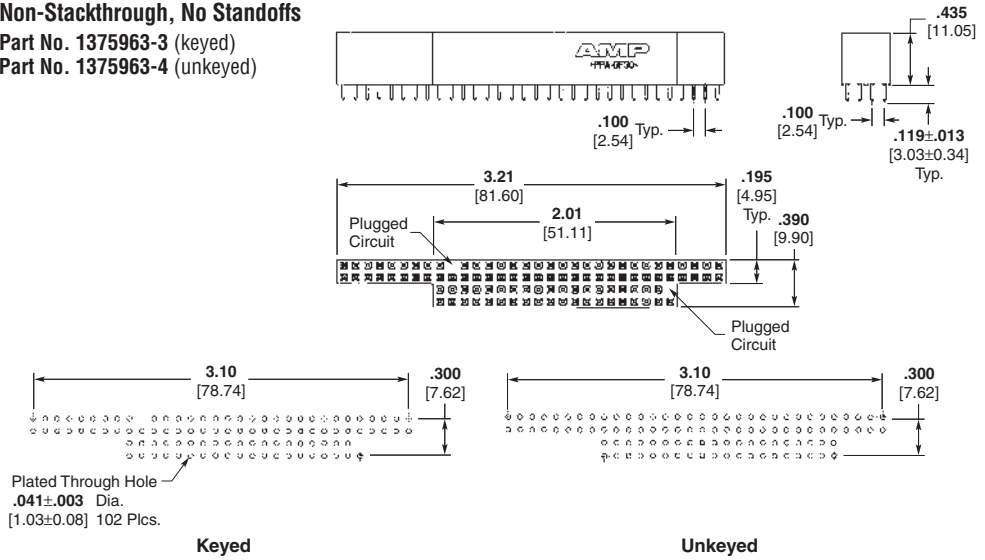

Recommended PC Board Layout

**Non-Stackthrough, 2 Standoffs**

**Part No. 1375961-3** (keyed)  
**Part No. 1375961-4** (unkeyed)

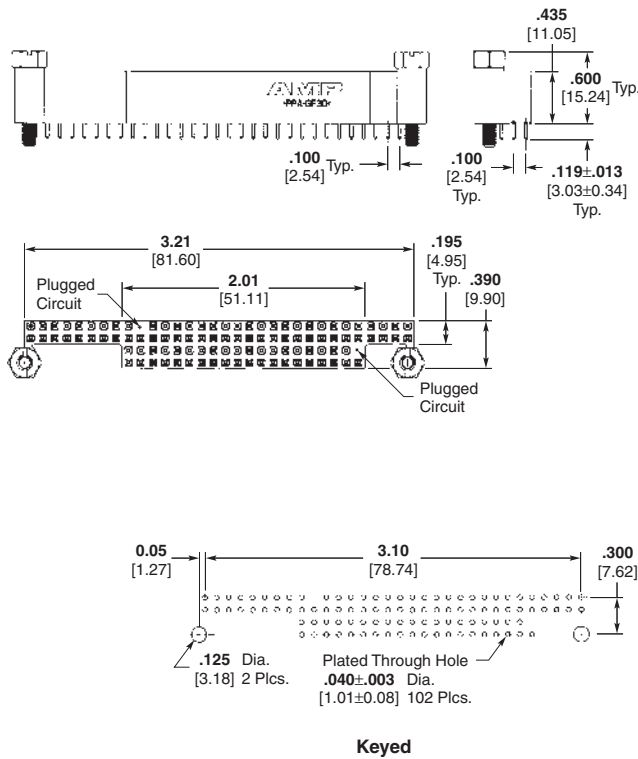

Recommended PC Board Layout

**Non-Stackthrough, 4 Standoffs**

**Part No. 1375959-3** (keyed)  
**Part No. 1375959-4** (unkeyed)

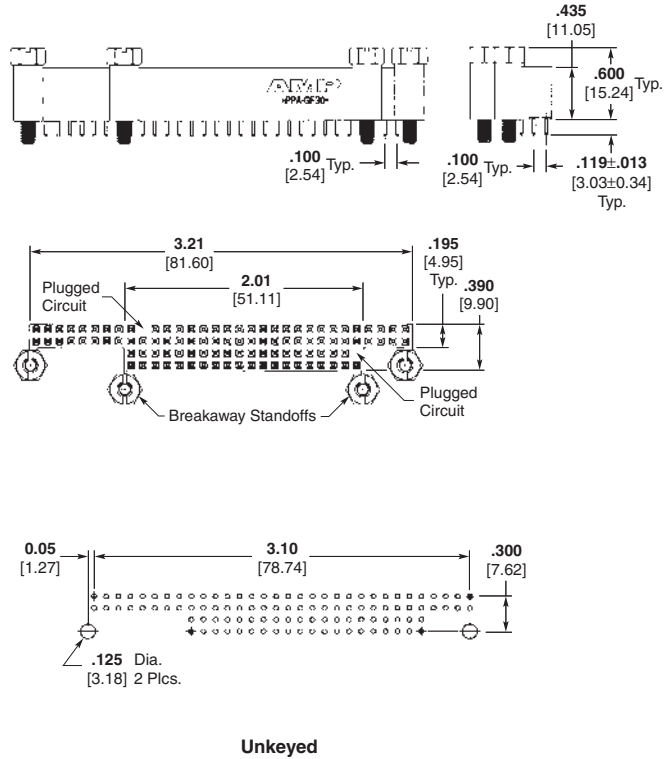

**Note:** All part numbers are RoHS compliant.

## PC/104-Plus, Solder

### Material and Finish

**Housing** — Glass filled thermoplastic, Black, 94V-0 rated

### Contacts

**Non-Stackthrough** — Phosphor Bronze; plated .000015 [0.00038] min. Gold on mating receptacle end, .000100 [0.00254] matte tin on remainder, all over .000050 [0.00127] Nickel

**Screwlocks** — Steel, Clear Chromate over Zinc

### Non-Stackthrough, No Standoffs

**Part No. 1375967-4** (unkeyed)

**Part No. 1375967-5** (keyed-A1)

per PC/104-Plus specification

**Part No. 1375967-6** (keyed-D30)

per PC/104-Plus specification

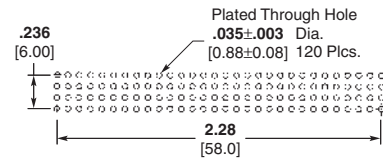
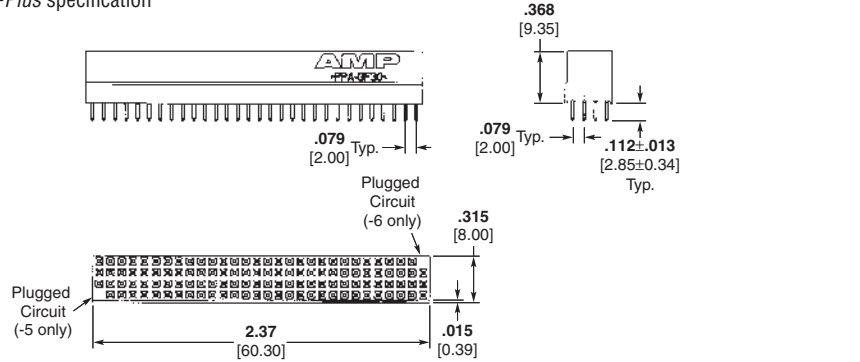

Recommended PC Board Layout for 1375967-4

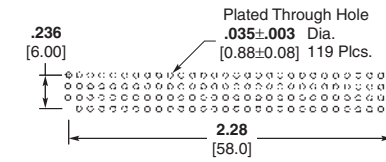

Recommended PC Board Layout for 1375967-5

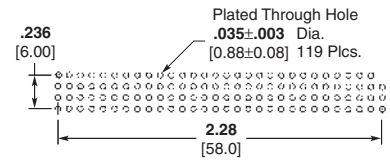

Recommended PC Board Layout for 1375967-6

### Non-Stackthrough, 2 Standoffs

**Part No. 1375965-4** (unkeyed)

**Part No. 1375965-5** (keyed-A1)

per PC/104-Plus specification

**Part No. 1375965-6** (keyed-D30)

per PC/104-Plus specification

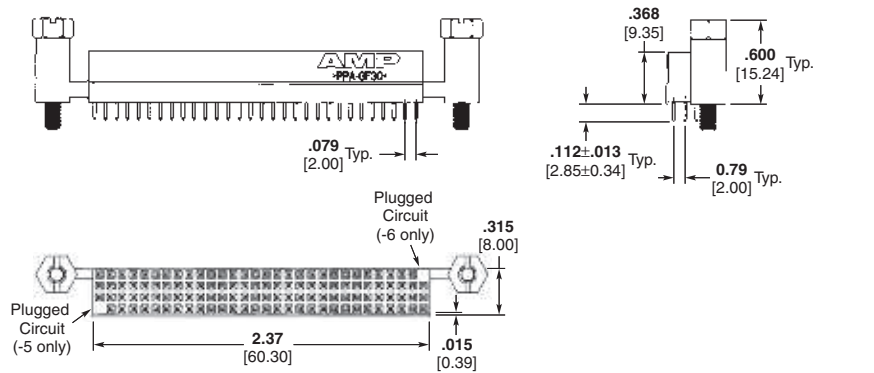

Recommended PC Board Layout for 1375965-4

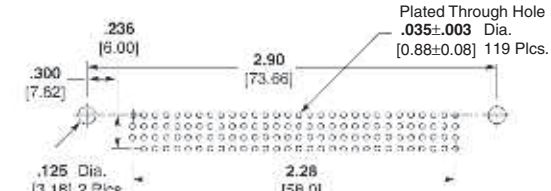

Recommended PC Board Layout for 1375965-5

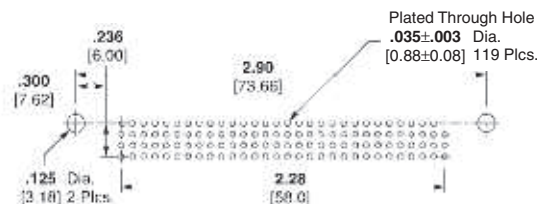

Recommended PC Board Layout for 1375965-6

**Note:** All part numbers are RoHS compliant.

### Accessories

#### Shroud, PC/104-Plus Part No. 1375801-1

Material — PBT, Black

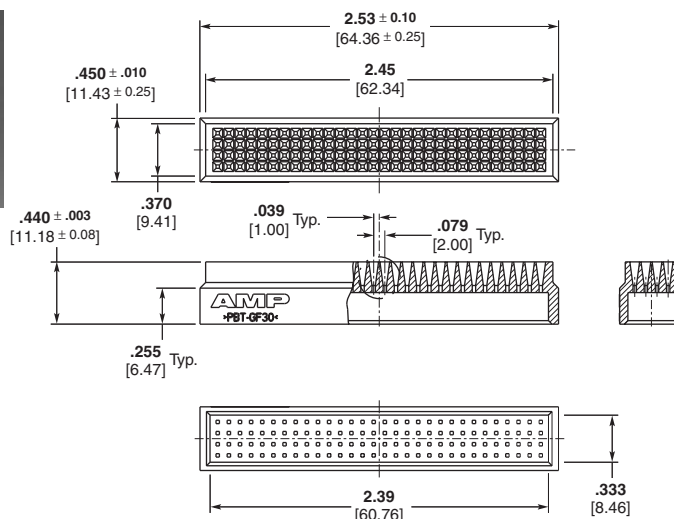
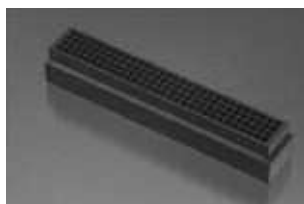

#### Organizer, PC/104 Part Number 1445251-1

Material — Polyester, PBT, Black

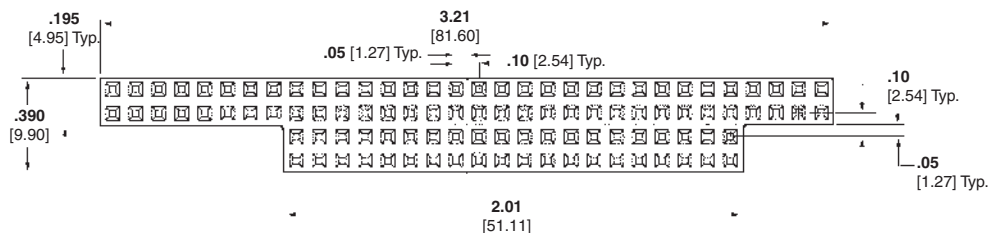

#### Kit Packaging Part Numbers

Part Number	Component Part Number		Style
	Connector Assembly	Organizer	
1445441-3	1375795-3	1445251-1	Keyed
1445441-4	1375795-4	1445251-1	Unkeyed
1445440-3	1375793-3	1445251-1	Keyed
1445440-4	1375793-4	1445251-1	Unkeyed
1445439-3	1375791-3	1445251-1	Keyed
1445439-4	1375791-4	1445251-1	Unkeyed

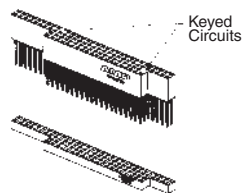

Part No. 1445441-3

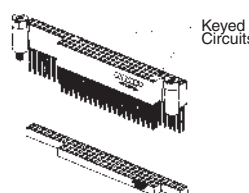

Part No. 1445440-3

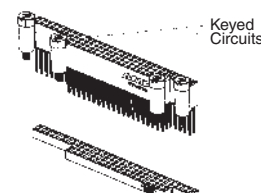

Part No. 1445439-3

Note: All part numbers are RoHS compliant.

**AMPMODU 50/50 Grid Connector System**

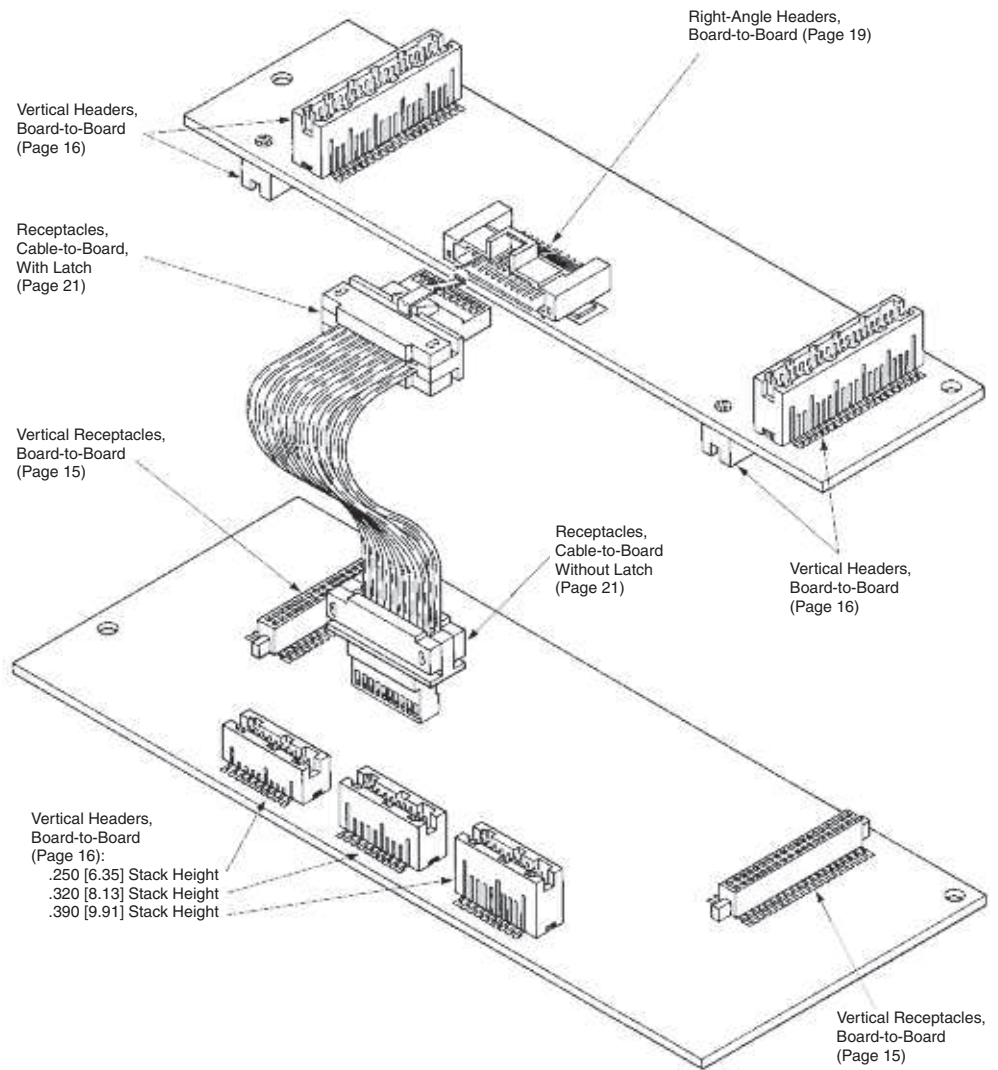

**Produced under a Quality Management System certified to ISO 9001**

A copy of the certificate is available upon request.



## Board-to-Board Vertical Receptacles and Headers

### Product Facts

- Surface-mount products for parallel board-to-board applications, as well as right-angle board-to-board and cable-to-board applications
- High density .050 x .050 [1.27x1.27] centerline grid
- Three board-to-board stack heights: .250 [6.35], .320 [8.13] and .390 [9.91]
- Non-protrusive metallic holddowns
- Reliable dual beam receptacle contacts for redundant contact
- Duplex plated receptacle and post contacts; gold plated on mating areas, tin plated on tails
- Compatible with standard surface-mount processing (VPR and IR)
- Receptacle and header allow for drainage of processing fluids
- Tape and reel packaging available. Contact TE for details
- Polarized header and receptacle assemblies
- Sizes of 10, 20, 30, 40, 50, 60, 70, 80 and 100 positions
- Recognized under the Component Program of Underwriters Laboratories Inc., File No. E28476
- Certified by Canadian Standards Association File No. LR7189

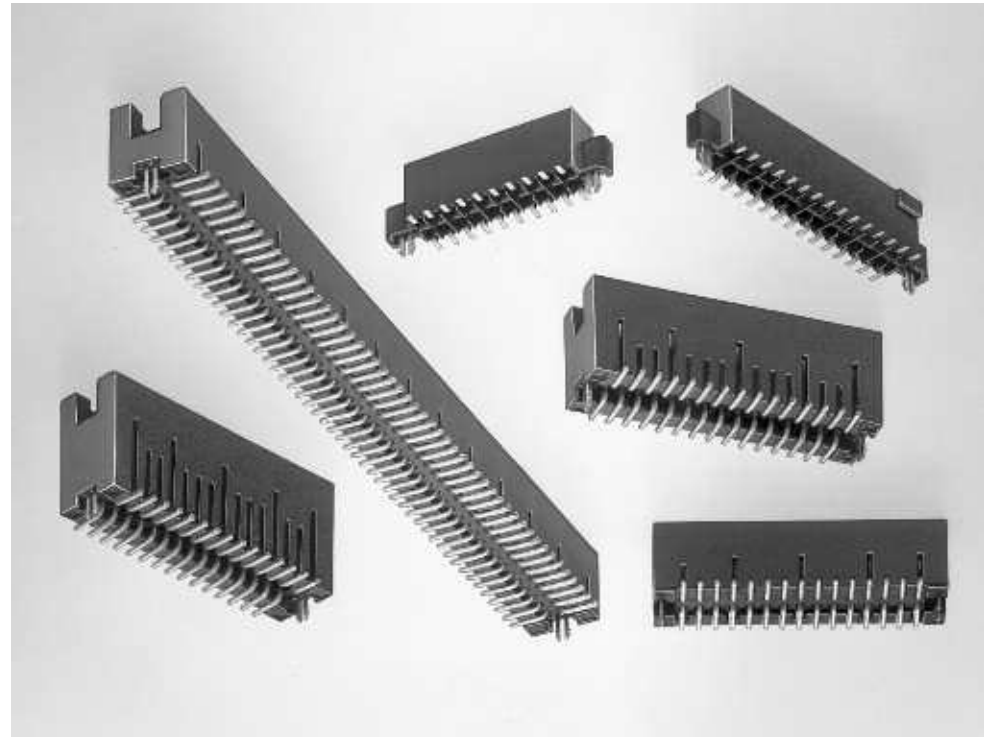

AMPMODU 50/50 Grid Vertical Headers and Receptacles are designed for parallel board-to-board stacking in high density applications.

Right-angle board-to-board and cable-to-board applications are also possible, since the vertical receptacles also mate with non-latching right-angle headers (page 19) and the vertical headers also mate with non-latching cable connectors.

Available are double row, vertical shrouded headers and receptacles in sizes ranging from 10 through 100 positions (in 10 position increments).

Parallel board-to-board stack heights of .250 [6.35], .320 [8.13] and .390 [9.91] are achievable by selection of the appropriate header. The receptacle is the same for all three stack height headers.

Non-protrusive metallic holddowns are designed for use in .062 [1.57] or thicker

PC boards and allow surface mounting to both sides of the board. In addition to providing retention during processing, the holddowns are soldered during reflow and therefore provide long-term strain relief for the solder joints.

AMPMODU 50/50 Grid Vertical Headers and Receptacles are designed to be compatible with standard surface-mount processes; IR (infrared) and VPR (vapor phase reflow). The surface-mount connectors have been designed so that dimensioning, tolerances, referenced datums, holddown characteristics

and packaging methods result in a system that is compatible with robotic assembly.

The headers and receptacles feature polarization to prevent misalignment.

### Three Board Stack Heights

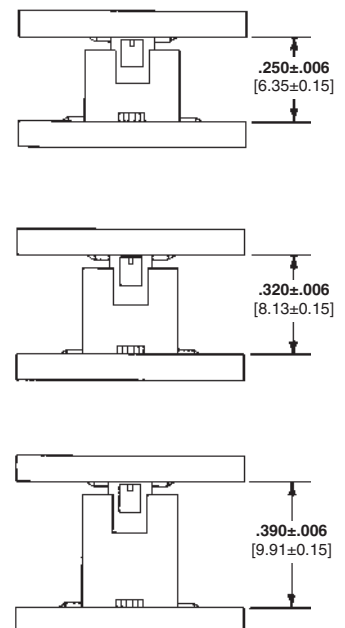

### Non-Protrusive Metallic Holddowns

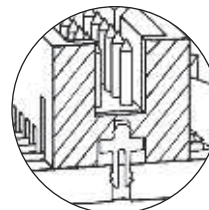

## Board-to-Board Vertical Receptacles, Double Row, .050 x .050 [1.27 x 1.27] Centerline



### Material and Finish

**Housing**—Glass-filled thermoplastic, black, 94V-0 rated

**Contacts**—Copper alloy; duplex plated .000030 [0.00076] gold in mating area, .000150 [0.00381] tin on solder tail, with entire contact underplated .000050 [0.00127] nickel

**Holddown**—Copper alloy; plated .000150 [0.00381] tin over .000050 [0.00127] nickel

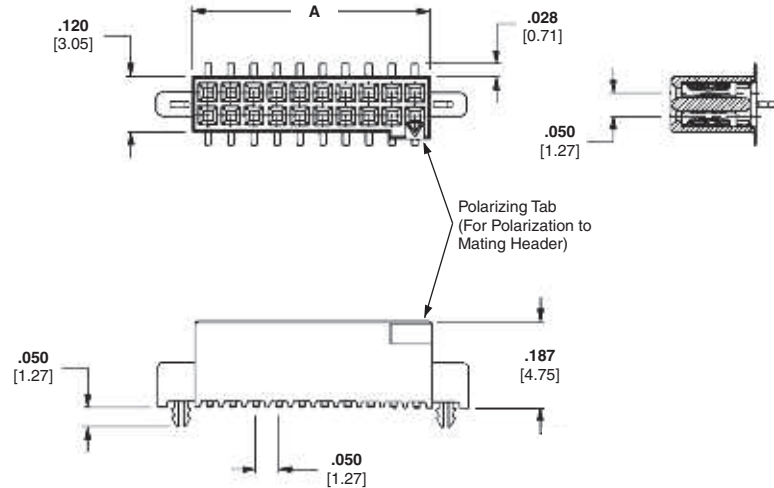

### Related Product Data

**Mating Headers** — pages 16, 19

**PC Board Layouts** — page 17

**Performance Specifications** — page 24

**Technical Documents** — page 24

**Product Specification** 108-1332

**Application Specification** 114-7010

**Packaging:** Tube or Tape and Reel

No. of Pos.	Dimension A	Receptacle Part Numbers		
		Tube	Tape and Reel*	No Hold Down w/Vacuum Cover
10	.266 [6.75]	5-104652-1	5-147384-1	5-147413-1
20	.516 [13.11]	5-104652-2	5-147384-2	5-147413-3
30	.766 [19.46]	5-104652-3	5-147384-3	5-147413-4
40	1.016 [25.81]	5-104652-4	5-147384-4	—
50	1.266 [32.16]	5-104652-5	5-147384-5	5-147413-2
60	1.516 [38.51]	5-104652-6	5-147384-6	—
70	1.766 [44.86]	5-104652-7	5-147384-7	—
80	2.016 [51.21]	5-104652-8	5-147384-8	—
100	2.516 [63.91]	6-104652-0	5-147384-9	—

\* Parts packaged in tape and reel have vacuum pick and place cover. See PC Board Layout on page 17.

**Note:** All part numbers are RoHS compliant.

## Board-to-Board Vertical Headers, Double Row, .050 x .050 [1.27 x 1.27] Centerline



For .250 [6.35] Mated Height



For .320 [8.13] Mated Height



For .390 [9.91] Mated Height

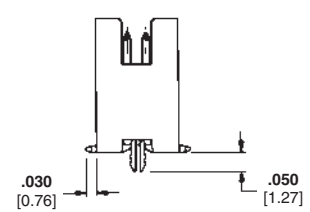
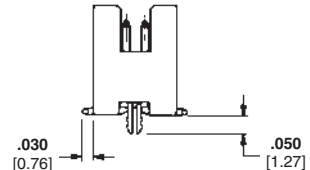
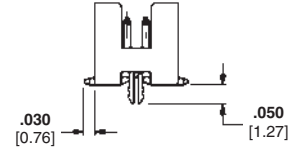
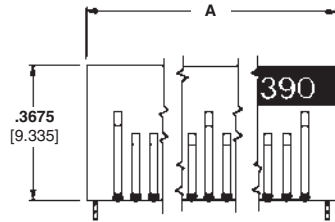
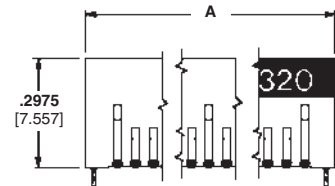
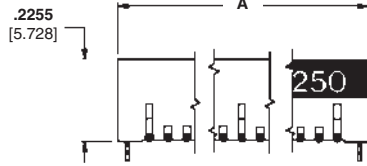
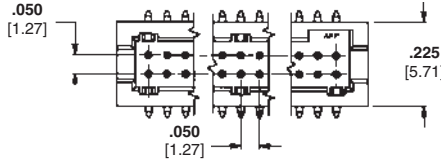

### Material and Finish

**Housing**—Glass-filled thermoplastic, black, 94V-0 rated

**Contacts**—Copper alloy; duplex plated .000030 [0.00076] gold in mating area, .000150 [0.00381] tin on solder tail, with entire contact underplated .000050 [0.00127] nickel

**Holddown**—Copper alloy; plated .000150 [0.00381] tin over .000050 [0.00127] nickel

### Related Product Data

**Mating Receptacles** — page 15, 21 (without latch only)

**PC Board Layouts** — page 17

**Performance Specifications** — page 24

### Technical Documents — page 24

**Product Specification** 108-1332

**Application Specification** 114-7010

**Packaging:** Tube or Tape and Reel

No. of Pos.	Dimension A	Header Part Numbers								
		.250 [6.35] Mated Height			.320 [8.13] Mated Height		.390 [9.91] Mated Height			
		Tubes	Tape & Reel*		Tubes	Tape & Reel*	Tubes		Tape & Reel*	
		Hold Down	No Hold Down			Hold Down	No Hold Down			
10	.372 [9.44]	5-104655-1	5-147381-1	5-147121-1	5-104656-1	5-147382-1	5-104693-1	—	5-147383-1	
20	.622 [15.79]	5-104655-3	5-147381-2	5-147121-2	5-104656-2	5-147382-2	5-104693-2	—	5-147383-2	
30	.872 [22.14]	5-104655-4	5-147381-3	—	5-104656-3	5-147382-3	5-104693-3	—	5-147383-3	
40	1.122 [28.49]	5-104655-5	5-147381-4	—	5-104656-4	5-147382-4	5-104693-4	—	5-147383-4	
50	1.372 [34.84]	5-104655-6	5-147381-5	—	5-104656-5	5-147382-5	5-104693-5	—	5-147383-5	
60	1.622 [41.19]	5-104655-7	5-147381-6	—	5-104656-6	5-147382-6	5-104693-6	—	5-147383-6	
70	1.872 [47.54]	5-104655-8	5-147381-7	—	5-104656-7	5-147382-7	5-104693-7	—	5-147383-7	
80	2.122 [53.89]	5-104655-9	5-147381-8	—	5-104656-8	5-147382-8	5-104693-8	—	5-147383-8	
90	2.372 [60.24]	—	—	—	5-104656-9	—	5-104693-9	—	—	
100	2.622 [66.59]	6-104655-1	5-147381-9	—	6-104656-0	5-147382-9	6-104693-0	5-147503-1	5-147383-9	

\*Parts packaged in tape and reel have vacuum pick and place cover. See PC Board Layout on page 17.

**Note:** All part numbers are RoHS compliant.

Vertical Headers, Double Row  
**2**



## Recommended PC Board Layouts for Vertical Connectors

### Headers

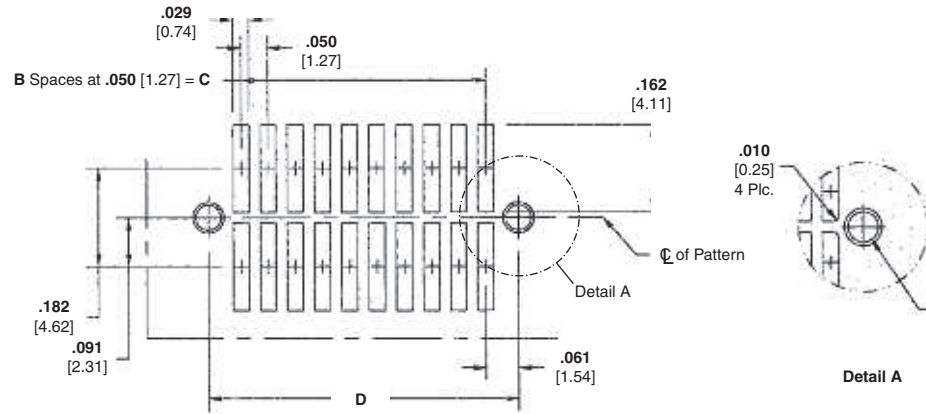

### Receptacles

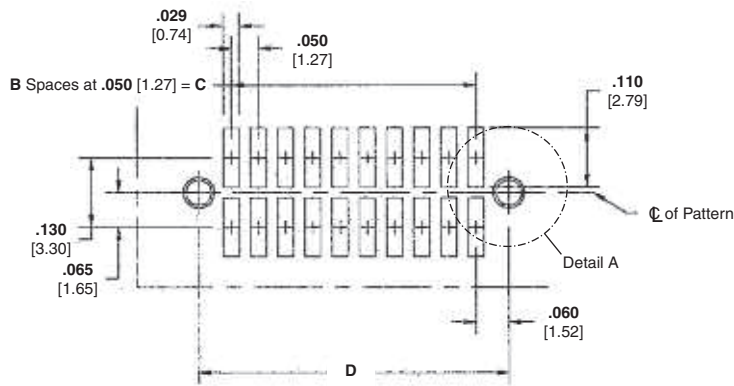



No. of Pos.	Receptacle Dimensions			Header Dimensions		
	B	C	D	B	C	D
10	4	.200 [5.08]	.320 [8.12]	4	.200 [5.08]	.322 [8.17]
20	9	.450 [11.43]	.570 [14.48]	9	.450 [11.43]	.572 [14.52]
30	14	.700 [17.78]	.820 [20.83]	14	.700 [17.78]	.822 [20.87]
40	19	.950 [24.13]	1.070 [27.19]	19	.950 [24.13]	1.072 [27.22]
50	24	1.200 [30.48]	1.320 [33.53]	24	1.200 [30.48]	1.322 [33.57]
60	29	1.450 [36.83]	1.570 [39.88]	29	1.450 [36.83]	1.572 [39.92]
70	34	1.700 [43.18]	1.820 [46.23]	34	1.700 [43.18]	1.822 [46.27]
80	39	1.950 [49.53]	2.070 [52.58]	39	1.950 [49.53]	2.072 [52.62]
90	44	2.200 [55.88]	2.320 [58.93]	44	2.200 [55.88]	2.322 [58.97]
100	49	2.450 [62.23]	2.570 [65.28]	49	2.450 [62.23]	2.572 [65.32]

**Note:** Refer to TE Customer Drawings for additional PC board layout information and dimensional tolerances.

**Note:** All part numbers are RoHS compliant.

**Product Facts**

- Surface-mount products for right-angle board-to-board and cable-to-board applications
- Double-row, right-angle shrouded headers
- High density .050 x .050 [1.27 x 1.27] centerline grid
- Latching and non-latching versions available
- Non-protrusive metallic holddowns
- Metallic tabs, when soldered to PC board pad, provide added mechanical support
- Duplex plated post contacts; gold plated on mating area, tin plated on tails
- Compatible with standard surface-mount processing (VPR and IR)
- Standoffs on header housings allow for drainage of processing fluids
- All headers are polarized
- Sizes of 10, 20, 30, 40, 50, 60, 70, 80 and 100 positions
- Recognized under the Component Program of Underwriters Laboratories Inc., File No. E28476 
- Certified by Canadian Standards Association File No. LR7189 

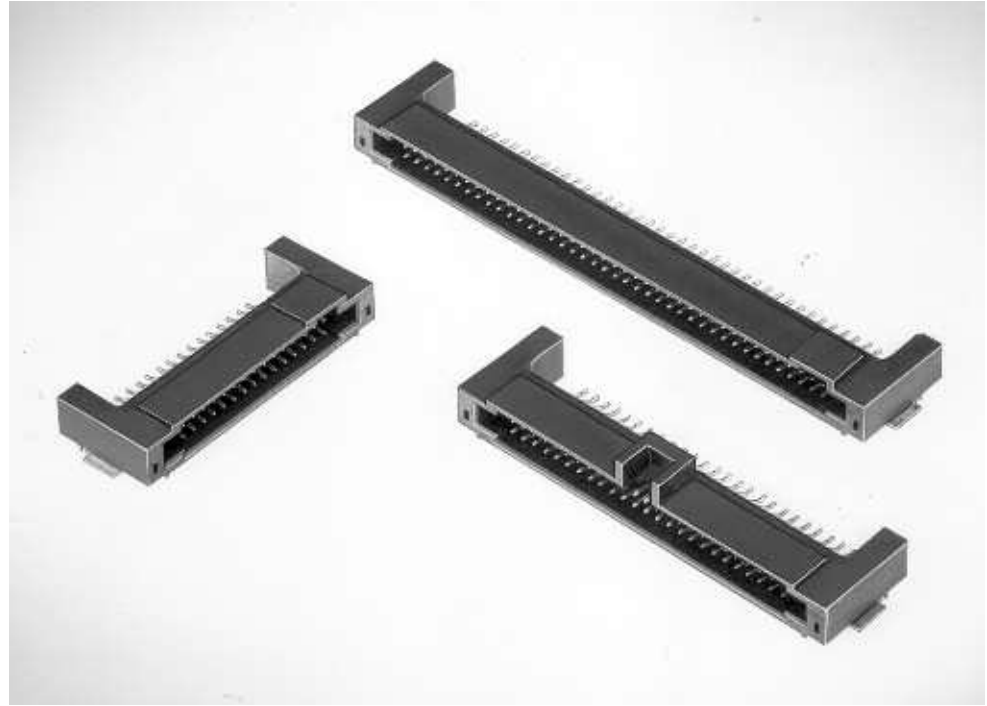

AMPMODU 50/50 Grid Right-Angle Headers will accommodate a variety of high density packaging applications; right-angle board-to-board applications when mated with vertical receptacles (page 15) and right-angle cable-to-board applications when mated with cable connectors (page 21). The small .050 x .050 [1.27 x 1.27] centerline contact spacing allows efficient use of the PC board area.

Mechanical support of the headers to the PC board is provided by non-protrusive metallic holddowns designed for .062 [1.57] or thicker PC boards. These holddowns are of the same

design as those used in the vertical headers (page 16) and receptacles (page 15). There are also metallic tabs that are soldered to the surfaces of the PC board pads for added support.

AMPMODU 50/50 Grid Right-Angle Headers are available in double-row, in either latching or non-latching versions, and in sizes ranging from 10 through 100 positions (in 10 position increments). The latching version provides positive retention when mated with the latching cable connector (page 21). All headers feature polarization to help prevent misalignment during mating.

## Board-to-Board Right-Angle Headers, Double Row, .050 x .050 [1.27 x 1.27] Centerline

### Non-Latching Header

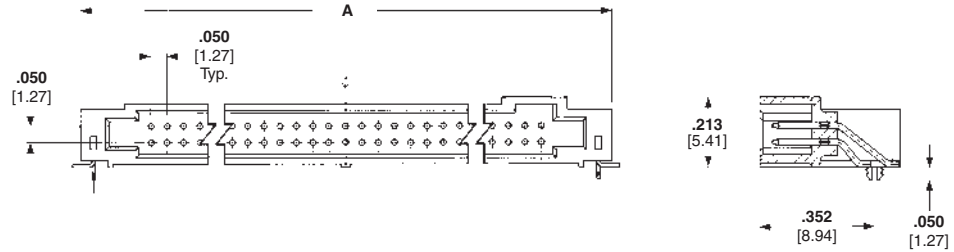

### Latching Header

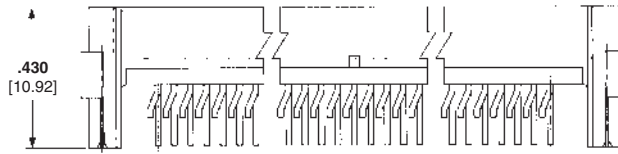
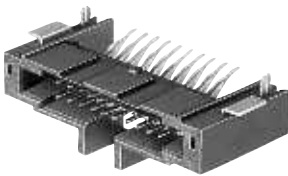

### Material and Finish

**Housing** — Liquid crystal polymer, black, 94V-0 rated

**Contacts** — Copper alloy; duplex plated .000030 [0.00076] gold in mating area, .000150 [0.000381] tin on solder tail, with entire contact under-plated .000050 [0.00127] nickel

**Holddown** — Copper alloy; plated .0000150 [0.00381] tin over .000050 [0.00127] nickel

### Related Product Data

**Mating Receptacles** — page 15, 21

**Performance Specifications** — page 24

**Technical Documents** — page 24

**Product Specification** 108-1443

**Application Specification** 114-7010

**Packaging:** Tube

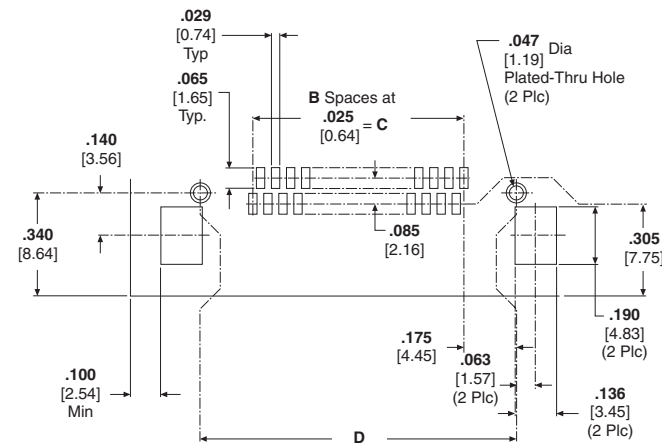

Recommended PC Board Layout



**Note:** Refer to TE Customer Drawings for additional PC board layout information and dimensional tolerances.

No. of Pos.	Dimensions				Header Part Numbers	
	A	B	C	D	Latching	Non-Latching
10	.630 [16.00]	9	.225 [5.72]	.550 [13.97]	5-104895-1	5-104894-1
20	.880 [22.35]	19	.475 [12.07]	.800 [20.32]	5-104895-2	5-104894-2
30	1.130 [28.70]	29	.725 [18.42]	1.050 [26.67]	5-104895-3	5-104894-3
40	1.380 [35.05]	39	.975 [24.77]	1.300 [33.02]	5-104895-4	5-104894-4
50	1.630 [41.40]	49	1.225 [31.12]	1.550 [39.37]	5-104895-5	5-104894-5
60	1.880 [47.75]	59	1.475 [37.47]	1.800 [45.72]	5-104895-6	5-104894-6
70	2.130 [54.10]	69	1.725 [43.82]	2.050 [52.07]	5-104895-7	5-104894-7
80	2.380 [60.45]	79	1.975 [50.17]	2.300 [58.42]	5-104895-8	5-104894-8
100	2.880 [73.15]	99	2.475 [62.87]	2.800 [71.12]	6-104895-0	6-104894-0

**Note:** All part numbers are RoHS compliant.

## Cable-to-Board Connectors

### Product Facts

- Double-row receptacle connectors provide cable-to-board connection capabilities for vertical headers (non-latching) and right-angle headers (latching and non-latching)
- IDC (Insulation Displacement Crimp) mass termination of solid or stranded round conductor .050 [1.27] centerline ribbon cable with PVC or polyethylene insulation
- Accommodates ribbon cable conductor sizes of 28 AWG [0.08-0.09 mm<sup>2</sup>] and 30 AWG [0.05 mm<sup>2</sup>] and insulation diameters up to .036 [0.91] maximum
- Reliable single beam receptacle contact design
- Duplex plated receptacle contacts; gold plated in mating area, tin in termination area
- Terminating covers (sold separately) provide both strain relief and protection to the termination area
- Sizes of 10, 20, 30, 40, 50, 60, 70, 80 and 100 positions
- Connectors available with or without metal latch
- Connectors without latches are polarized to help prevent mismatching
- Recognized under the Component Program of Underwriters Laboratories Inc.,  File No. E28476
- Certified by Canadian Standards Association  File No. LR7189

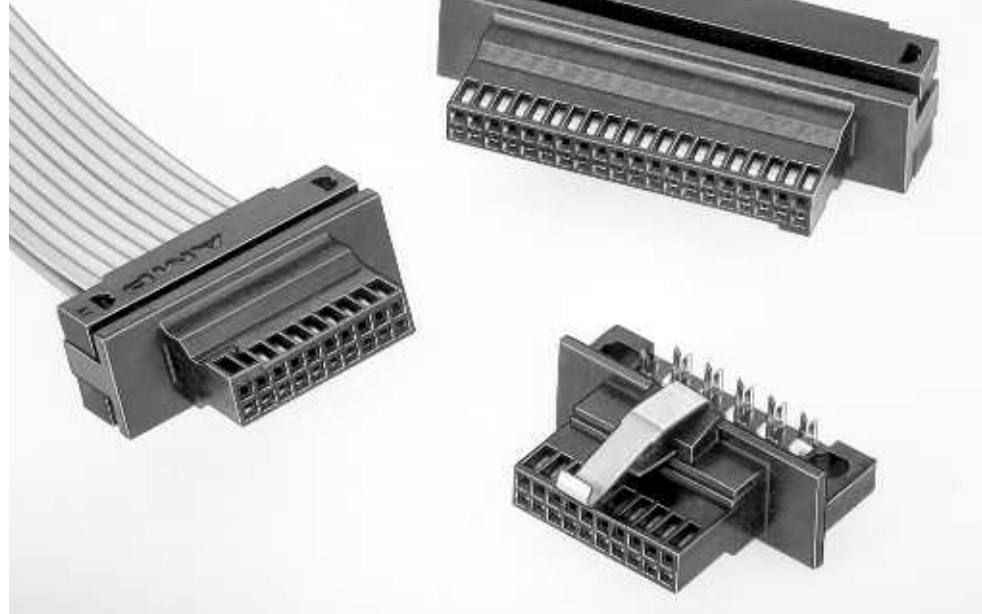

These double-row cable connectors, with a .050 x .050 [1.27 x 1.27] centerline contact spacing, provide cable-to-board connection capabilities for the AMPMODU 50/50 Grid Connector System. Cable connectors without a latch will mate with the vertical headers (page 16), while cable connectors with or without a latch can be used to mate with the right-angle headers (page 19).

The cable connectors feature reliable single-beam IDC (insulation displacement crimp) contacts which are duplex plated with .000030 [0.00076] gold. These contacts can be mass terminated to either solid or

stranded round conductor ribbon cable with conductor sizes of 28 AWG [0.08-0.09 mm<sup>2</sup>] and 30 AWG [0.05 mm<sup>2</sup>] and a maximum insulation diameter of .036 [0.91]. During termination, the terminating covers, which must be purchased separately, assist in guiding the wire into the IDC contacts, then provide strain relief when fully seated. Actual termination is accomplished with the TE manual tooling shown on page 23.

The latching version of the cable connector is equipped with a metal latch which provides positive retention of the receptacle cable connector when mated with a surface-

mounted right-angle header. The cable connector without a metal latch features polarization to help prevent mismatching. All connectors are available in sizes ranging from 10 through 100 positions (in 10 position increments).

### Cable-to-Board Receptacle Connectors, Double Row, .050 x .050 [1.27 x 1.27] Centerline

Receptacle Connectors, Double Row, With and Without Latch

2

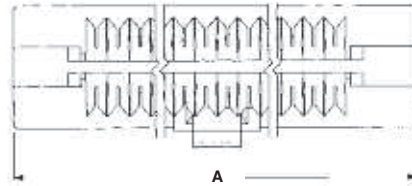
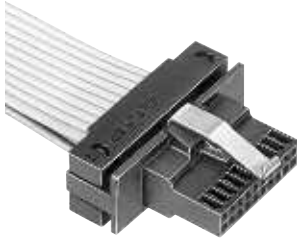

**Material and Finish**

**Housing** — Thermoplastic, black, 94V-0 rated

**Latch** — Stainless steel

**Contacts** — Phosphor bronze; duplex plated .000030 [0.00076] minimum gold in mating area, .000150 [0.00381] minimum tin on solder tail, with entire contact underplated .000050 [0.00127] minimum nickel

**Related Product Data**

**Mating Headers** — page 16, 19 (latching)

**Terminating Covers (Must be Purchased Separately, 2 Required per Connector)** — page 22

**Termination Tooling** — page 23

**Performance Specifications** — page 24

**Technical Documents** — page 24

**Product Specification** 108-1443

**Application Specification**  
408-9817, 408-9909

**Packaging:** Tube

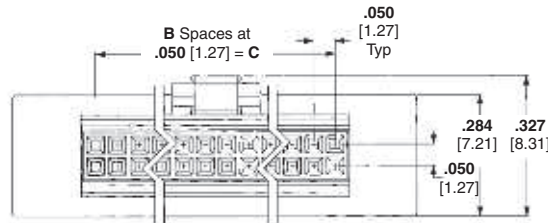
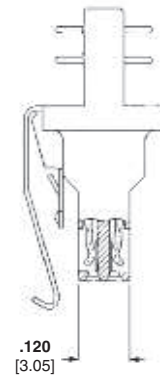
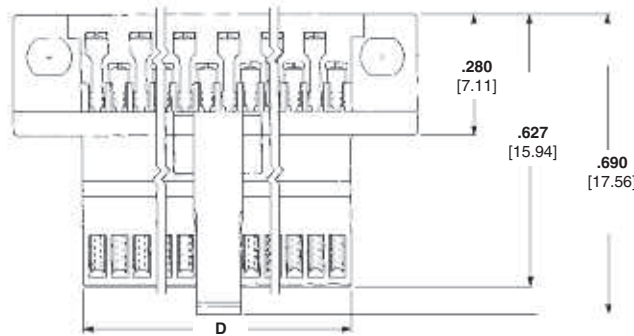

No. of Pos.	Dimensions				Receptacle Part Numbers	
	A	B	C	D	With Latch	Without Latch
10	.578 [14.68]	4	.200 [5.08]	.266 [6.76]	5-104892-1	5-104893-1
20	.828 [21.03]	9	.450 [11.43]	.516 [13.11]	5-104892-2	5-104893-2
30	1.078 [27.38]	14	.700 [17.78]	.766 [19.46]	5-104892-3	5-104893-3
40	1.328 [33.73]	19	.950 [24.13]	1.016 [25.81]	5-104892-4	5-104893-4
50	1.578 [40.08]	24	1.200 [30.48]	1.266 [32.16]	5-104892-5	5-104893-5
60	1.828 [46.43]	29	1.450 [36.83]	1.516 [38.51]	5-104892-6	5-104893-6
70	2.078 [52.78]	34	1.700 [43.18]	1.766 [44.86]	5-104892-7	5-104893-7
80	2.328 [59.13]	39	1.950 [49.53]	2.016 [51.21]	5-104892-8	5-104893-8
100	2.828 [71.83]	49	2.450 [62.23]	2.516 [63.91]	6-104892-0	6-104893-0

**Note:** All part numbers are RoHS compliant.

## Terminating Covers for Cable Connectors



Cable Connector Terminating Cover, Double Row

### Material

Glass-filled thermoplastic, black, 94V-0 rated

### Related Product Data

**Connectors used with Covers** — page 21

**Termination Tooling** — page 23

**Technical Documents** — page 24

**Product Specification** 108-1443

**Application Specification** 408-9817, 408-9909

**Packaging:** Plastic bag

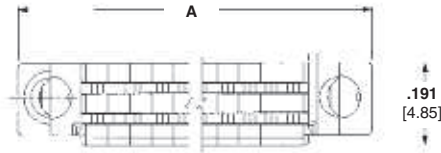

No. of Pos.	Dimension A	Terminator Cover Part Numbers
10	.565 [14.35]	104891-1
20	.815 [20.70]	104891-2
30	1.065 [27.05]	104891-3
40	1.315 [33.82]	104891-4
50	1.565 [39.75]	104891-5
60	1.815 [46.10]	104891-6
70	2.065 [52.45]	104891-7
80	2.315 [58.80]	104891-8
100	2.815 [71.50]	1-104891-0

**Note:** Terminating covers must be purchased separately, two are required for each cable connector.

**Note:** All part numbers are RoHS compliant.

## Application Tooling for Cable Connectors

The Manual Miniature Application Frame Assembly 91295-1, equipped with a Cover Closing Kit 543518-1, is used for the IDC termination of ribbon cable to the cable connectors shown on page 21.

Prior to termination, the covers must be partially assembled onto a connector housing, the cable inserted between the covers and contacts and the covers preclosed by hand, clamping the cable in place.

In the Manual Miniature Application Frame Assembly, the covers are fully seated to complete the mass termination and provide strain relief for the completed connection.



Manual Miniature Application Frame Assembly 91295-1 with Cover Closing Kit 543518-1

For tooling information, call Technical Support Center **1-800-522-6752**.

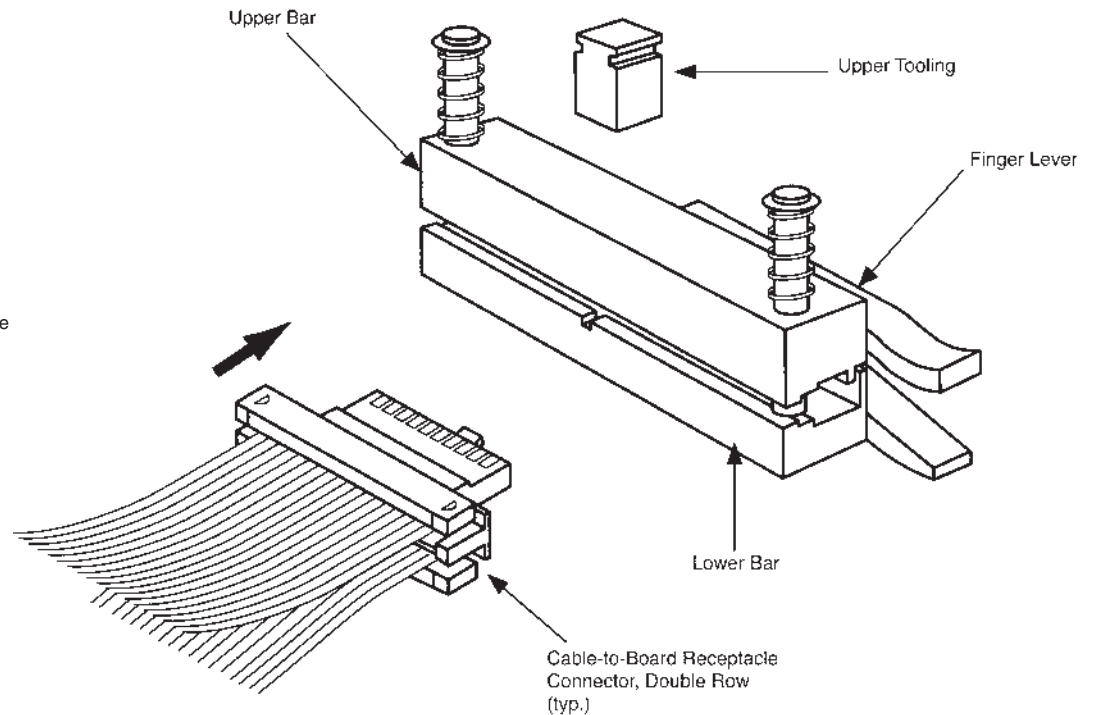

**Note:** Refer to Tyco Electronics Instruction Sheets 408-9817 (Frame Assembly 91295-1) and 408-9909 (Cover Closing Kit 543518-1) for complete termination/tooling information.

**Note:** All part numbers are RoHS compliant.

## Performance Specifications

### Board-to-Board Connectors, Vertical and Right-Angle

**Mating Force:** 6.4 oz (1.78 N) max. per contact  
**Unmating Force:** 1.0 oz [0.28 N] min. per contact  
**Durability:** Tested to 200 cycles min.  
**Current Rating:** (30°C T rise): .5 ampere per contact  
**Operating Temperature Range:** -65°C to +105°C  
**Termination Resistance:** 16 milliohms max. (initial)  
**Insulation Resistance:** 5000 megohms min. (initial)  
**Dielectric Withstanding Voltage:** 300 VAC

### Cable-to-Board Connectors

**Mating Force:** 6.4 oz (1.78 N) max. per contact  
**Unmating Force Without Latch:** .5 oz [0.14 N] min. per contact  
**Durability:** Tested to 200 cycles min.  
**Current Rating:** (10°C T rise): .5 ampere per contact  
**Operating Temperature Range:** -65°C to +105°C  
**Termination Resistance:** 25 milliohms max. (initial and final)  
**Insulation Resistance:** 5000 megohms min. (initial)  
**Dielectric Withstanding Voltage:** 300 VAC

## Technical Documents

Various technical documents are available for your use:

**Product Specifications** describe technical performance characteristics and verification tests. They are intended for the Design, Component and Quality Engineer.

108-1332          AMPMODU 50/50 Grid Vertical Board-to-Board Connectors  
108-1443          AMPMODU 50/50 Grid Right-Angle Board-to-Board and Cable Connectors

**Application Specifications** describe requirements for using the product in its intended application and/or crimping information. They are intended for the Packaging and Design Engineer and the Machine Setup Person.

114-7010          AMPMODU 50/50 Grid Connector System

**Instruction Sheets** provide instructions for assembling or applying the product. They are intended for the Manufacturing Assembler or Operator.

408-9817          Manual Miniature Application Frame Assembly 91295-1  
408-9909          Cover Closing Kit 543518-1

**Note:** All part numbers are RoHS compliant.



## AMPMODU System 50 Connectors

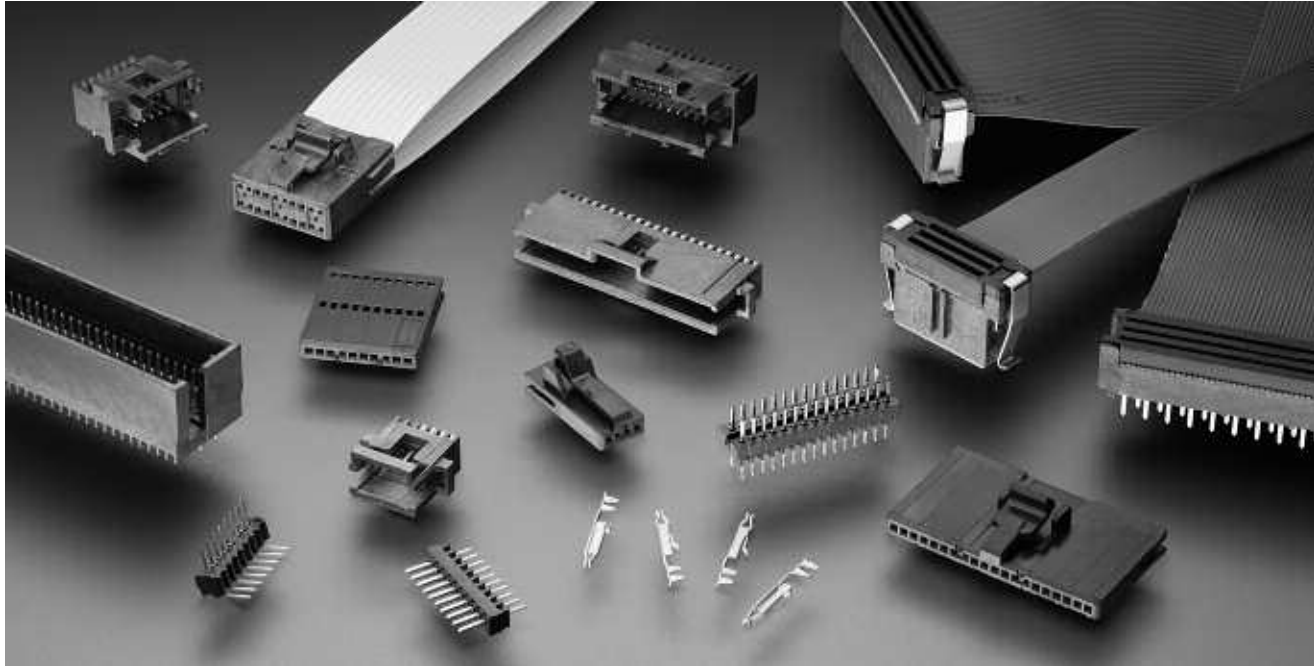

The AMPMODU System 50 connector family includes a wide variety of high density board-to-board (thru-hole and surface-mount) and cable-to-board connectors. AMPMODU System 50 is composed of one- and two-row receptacles and post headers on .050 x .100 [1.27 x 2.54] spacing between contacts for extreme density and efficient use of printed circuit board area.

AMPMODU System 50 receptacles and header assemblies can be categorized in three groups: board-mount headers, board-mount receptacles and cable-to-board receptacles. Receptacle contacts and mating .015 [0.38] square posts are formed from high conductivity copper alloy and are selectively plated with gold to promote higher performance and reliability.

Board-mounted thru-hole post headers and receptacle connectors are available for right-angle and vertical mating configurations. Surface-mounted connectors are available in vertical, double row styles for parallel stacking applications. Shrouded post headers provide polarization to mating cable receptacles and aid alignment of mating connectors. Unshrouded headers allow close stacking of daughter cards. Vertical stacking connectors space parallel mated boards as shown in the illustration on page 63. Housings on all board-mount assemblies are made of high temperature tolerant materials and incorporate stand-offs for free drainage of flux cleaning solutions.

Cable-to-board connectors have integral latches for positive locking to shrouded

mating headers (thru-hole or surface-mount). Ribbon cable connectors mass terminate 30 AWG [0.05 mm<sup>2</sup>] solid and 32 AWG [0.03 mm<sup>2</sup>] stranded, .025 [0.64] centerline ribbon cable with PVC or Teflon® insulation.

Connectors for mass termination to FFC cable or flexible etched circuitry have dual beam contacts; options include shielded cable and solder tabs. Both types of cable connectors are available as component parts and as completed assemblies.

The variety of components and application possibilities, combined with small size and outstanding quality, make AMPMODU System 50 suitable for high density systems.

■ **Recognized under the Component Program of Underwriters Laboratories Inc.** File No. E28476



■ **Certified by Canadian Standards Association\*,** File No. LR 7189

\*CSA certification pending on certain products, as noted.



**Dimensioning:**

Dimensions are in inches and millimeters. Values in brackets are metric equivalents. Metric symbols used are:

- mm (millimeter)
- cm (centimeter)
- m (meter)
- mm<sup>2</sup> (square millimeter)
- C (Celsius)
- N (newton)
- kg (kilogram)

■ **Produced under a Quality Management System certified to ISO 9001**

A copy of the certificate is available upon request.



Teflon® is a trademark of E.I. du Pont de Nemours and Company.

## Thru-Hole Headers—Shrouded, .050 x .100 [1.27 x 2.54] Centerline, Board-to-Board

### Product Facts

- High density; contacts spaced on .050 x .100 [1.27 x 2.54] centers
- Single row; select sizes 4 thru 50 positions
- Double row; select sizes 10 thru 100 positions
- Stand-offs for ease of cleaning
- High temperature tolerant thermoplastic housings
- Shrouded and unshrouded headers available in single and double row, vertical and right-angle configurations

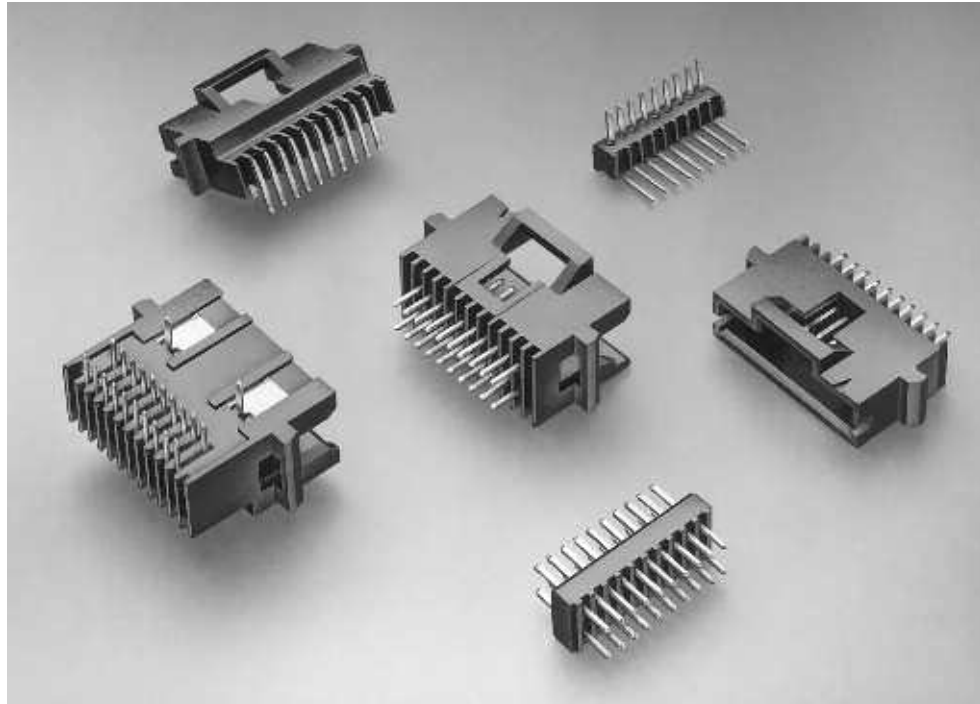

The AMPMODU System 50 interconnection system is designed to better meet industry's need for a high density interconnect system. The Board Mounted Thru-Hole Headers are available in shrouded and unshrouded versions. They are composed of single and double row post headers with .050 x .100 [1.27 x 2.54] spacing between contacts for extreme density and

efficient use of printed circuit board area. The headers are available in 4 through 50 positions, in a single row configuration, and 10 through 100 positions, in a double row design.

Board mounted post headers are available in right-angle and vertical configurations. Shrouded post headers provide polarization and alignment features for mating printed

circuit boards and cable connectors, while unshrouded headers allow close stacking of daughter cards. Housings for the headers are made of black thermoplastic material with a 94V-0 rating. The housings have stand-offs for free drainage of flux cleaning solutions.

## Thru-Hole Headers—Shrouded, .050 x .100 [1.27 x 2.54] Centerline, Board-to-Board (Continued)

### Single Row, Right-Angle with Solder Clips

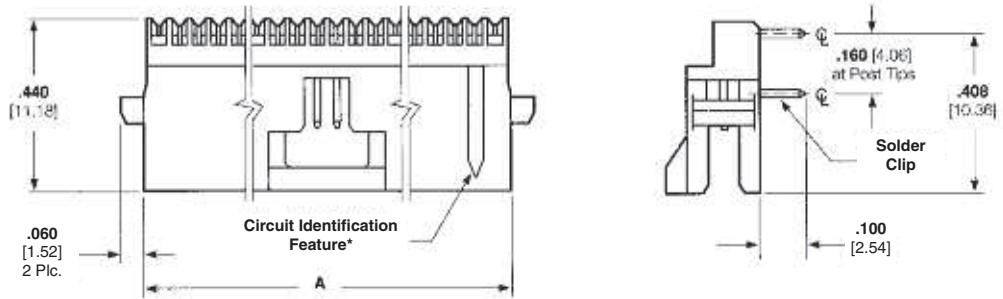

### Material and Finish

**Housing** — Glass-filled thermoplastic, black, 94V-0 rated

**Contacts** — Copper alloy; duplex plated .000030 [0.00076] gold in mating area, .000150 [0.00381] tin on solder posts, with entire contact underplated .000050 [0.00127] nickel

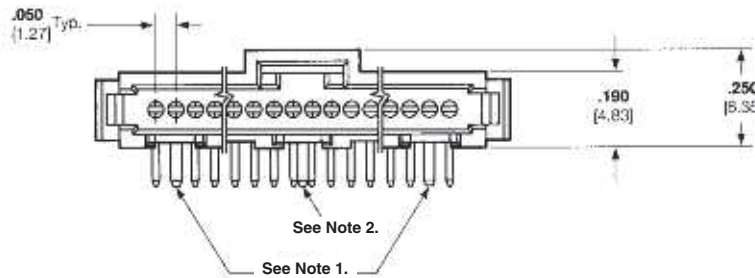

### Related Product Data

**Performance Characteristics** — page 63

**Mateable Connectors** — pages 38, 49 & 50

**PC Board Hole Layout** — page 41

**Technical Documents** — page 64

**Product Specification** 108-1093

**Application Specification** 114-25031

No. of Pos.	Dimension A	Part Numbers
4	.330 [8.38]	5-104074-7
5	.380 [9.65]	5-104074-2
6	.430 [10.92]	5-104074-8
8	.530 [13.46]	6-104074-0
10	.630 [16.00]	5-104074-1
12	.730 [18.54]	6-104074-1
15	.880 [22.35]	5-104074-3
20	1.130 [28.70]	5-104074-4
22	1.230 [31.24]	6-104074-4
25	1.380 [35.05]	5-104074-5
28	1.530 [38.86]	7-104074-0
30	1.630 [41.40]	5-104074-6
36	1.930 [49.02]	6-104074-6
40	2.130 [54.10]	6-104074-7
45	2.380 [60.45]	6-104074-8
50	2.630 [66.80]	6-104074-9

\*Circuit identification feature omitted on 4, 5 and 6 position headers.

**Notes:**

- Solder Clips located as shown for 10 through 30 position headers.
- Solder Clips located as shown for 4 through 8 and 36 through 50 position headers.

**Note:** All part numbers are RoHS compliant.

## Thru-Hole Headers—Shrouded, .050 x .100 [1.27 x 2.54] Centerline, Board-to-Board (Continued)

### Single Row, Vertical

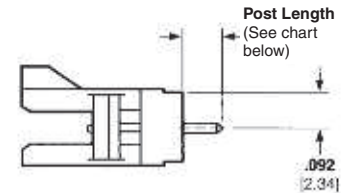
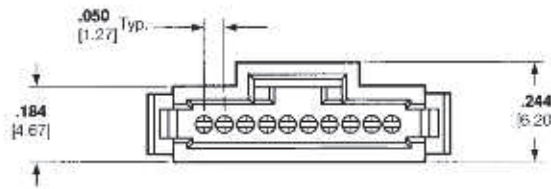
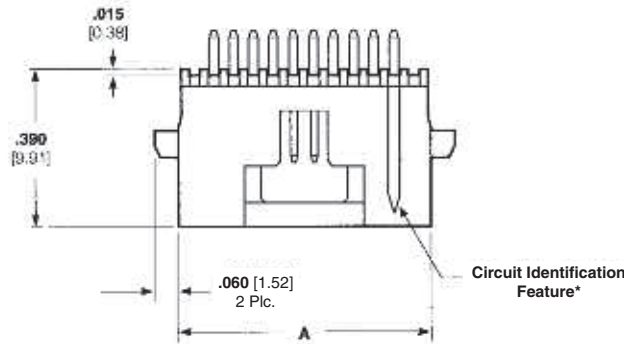
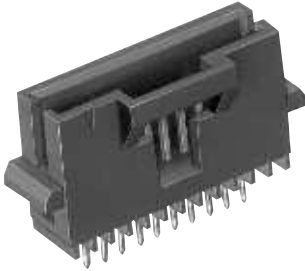

### Material and Finish

**Housing** — Glass-filled thermoplastic, black, 94V-0 rated

**Contacts** — Copper alloy; duplex plated .000030 [0.00076] gold in mating area, .000150 [0.00381] tin on solder posts, with entire contact underplated .00050 [0.00127] nickel

### Related Product Data

**Performance Characteristics** — page 63

**Mateable Connectors** — pages 38, 49 & 50

**Board-to-Board Spacing** — page 63

**PC Board Hole Layout** — page 41

**Technical Documents** — page 64

**Product Specification** 108-1093

**Application Specification** 114-25031

No. of Pos.	Dimension A	Part Numbers	
		Post Length	
		.100 [2.54]	.145 [3.68]
4	.330 [8.38]	5-104071-7	—
5	.380 [9.65]	5-104071-2	—
6	.430 [10.92]	5-104071-8	—
8	.530 [13.46]	6-104071-0	—
10	.630 [16.00]	5-104071-1	—
12	.730 [18.54]	6-104071-1	5-104804-3
13	.780 [19.81]	6-104071-2	—
15	.880 [22.35]	5-104071-3	5-104804-2
17	.980 [24.89]	6-104071-3	—
20	1.130 [28.70]	5-104071-4	—
22	1.230 [31.24]	6-104071-4	—
25	1.380 [35.05]	5-104071-5	—
30	1.630 [41.40]	5-104071-6	—
36	1.930 [49.02]	6-104071-6	—
40	2.130 [54.10]	6-104071-7	—
50	2.630 [66.80]	6-104071-9	—

\*Circuit identification feature omitted on 4, 5, and 6 position headers.

**Note:** All part numbers are RoHS compliant.

## Thru-Hole Headers—Shrouded, .050 x .100 [1.27 x 2.54] Centerline, Board-to-Board (Continued)

### Double Row, Right-Angle with Solder Clips

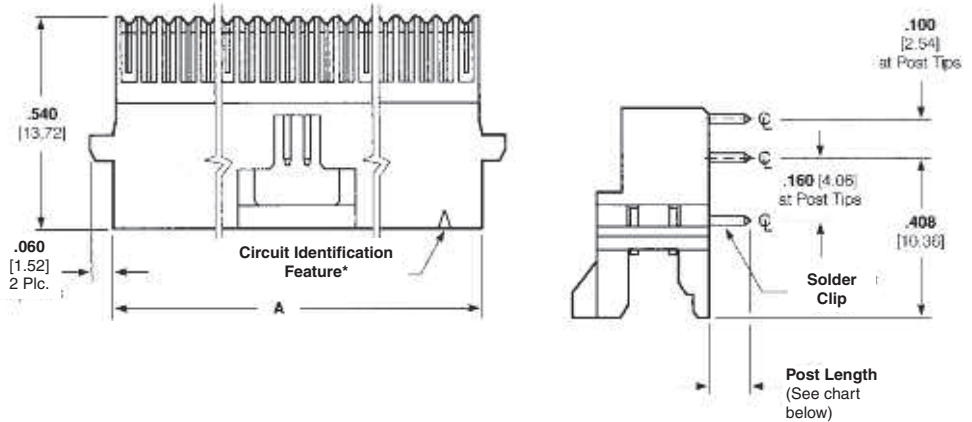
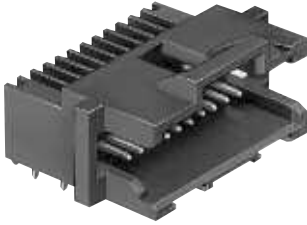

### Material and Finish

**Housing** — Glass-filled thermoplastic, black, 94V-0 rated

**Contacts** — Copper alloy; duplex plated .000030 [0.00076] gold in mating area, .000150 [0.00381] tin on solder posts, with entire contact underplated .000050 [0.00127] nickel

### Related Product Data

**Performance Characteristics** — page 63

**Mateable Connectors** — pages 40, 45, 51, 52, & 56

**PC Board Hole Layout** — page 41

**Technical Documents** — page 64

**Product Specification** 108-1093

**Application Specification** 114-25031

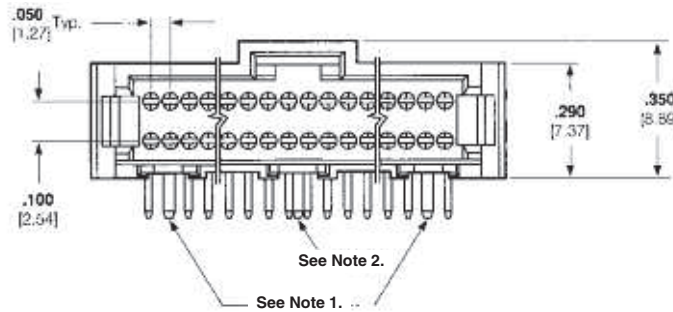

No. of Pos.	Dimension A	Part Numbers	
		Post Length	
		.100 [2.54]	.145 [3.68]
8	.330 [8.32]	5-104069-8	—
10	.380 [9.65]	5-104069-4	6-104477-2
12	.430 [10.92]	—	5-104477-8
14	.480 [12.19]	6-104069-0	—
16	.530 [13.46]	6-104069-1	—
20	.630 [16.00]	5-104069-1	5-104477-2
24	.730 [18.54]	6-104069-2	6-104477-0
26	.780 [19.81]	6-104069-3	—
30	.880 [22.35]	5-104069-5	5-104477-3
34	.980 [24.89]	6-104069-4	—
40	1.130 [28.70]	5-104069-6	5-104477-4
50	1.380 [35.05]	5-104069-2	5-104477-5
60	1.630 [41.40]	5-104069-7	5-104477-9
68	1.830 [46.48]	6-104069-8	—
72	1.930 [49.02]	6-104069-6	5-104477-1
80	2.130 [54.10]	5-104069-3	5-104477-6
100	2.630 [66.80]	6-104069-7	5-104477-7

\*Circuit identification feature omitted on 8, 10 and 12 position headers.

**Notes:**

1. Solder Clips located as shown for 16 through 100 position headers.
2. Solder Clips located as shown for 8 through 12 and 60 through 100 position headers.

**Note:** All part numbers are RoHS compliant.

## Thru-Hole Headers—Shrouded, .050 x .100 [1.27 x 2.54] Centerline, Board-to-Board (Continued)

### Double Row, Vertical

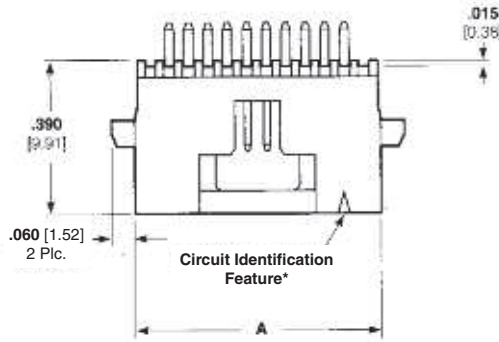
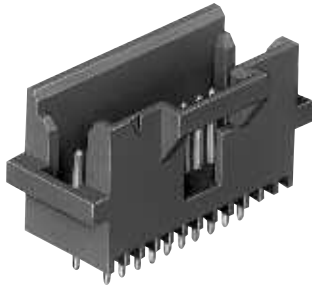

### Material and Finish

**Housing** — Glass-filled thermoplastic, black, 94V-0 rated

**Contact** — Copper alloy; duplex plated .000030 [0.00076] gold in mating area, .000150 [0.00381] tin on solder posts, with entire contact underplated .000050 [0.00127] nickel

### Related Product Data

**Performance Specifications** — page 63

**Mateable Connectors** — pages 40, 45, 51, 52, & 56

**Board-to-Board Spacing** — page 63

**PC Board Hole Layout** — page 41

**Technical Documents** — page 64

**Product Specification** 108-1093

**Application Specification** 114-25031

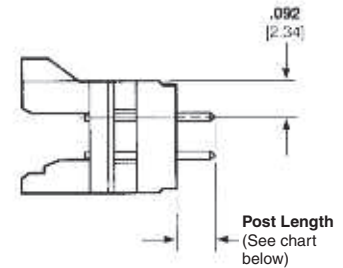
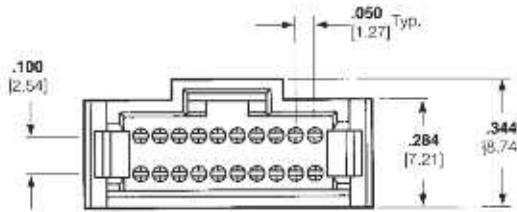

No. of Pos.	Dimension A	Part Numbers	
		Post Length	
		.100 [2.54]	.145 [3.68]
10	.380 [9.65]	5-104068-2	—
12	.430 [10.92]	5-104068-8	—
14	.480 [12.19]	5-104068-9	—
16	.530 [13.46]	6-104068-0	5-104666-9
20	.630 [16.00]	5-104068-1	5-104666-1
24	.730 [18.54]	6-104068-1	6-104666-0
26	.780 [19.81]	6-104068-2	—
30	.880 [22.35]	5-104068-3	5-104666-2
34	.980 [24.89]	6-104068-3	—
40	1.130 [28.70]	5-104068-4	5-104666-3
44	1.230 [31.24]	6-104068-4	—
50	1.380 [35.05]	5-104068-5	5-104666-4
60	1.630 [41.40]	5-104068-6	5-104666-7
68	1.830 [46.48]	6-104068-8	5-104666-8
72	1.930 [49.02]	6-104068-5	—
80	2.130 [54.10]	6-104068-6	5-104666-5
100	2.630 [66.80]	6-104068-7	5-104666-6

\*Circuit identification feature omitted on 10 and 12 position headers.

**Note:** All part numbers are RoHS compliant.

**Thru-Hole Headers—Shrouded, .050 x .100 [1.27 x 2.54] Centerline, Board-to-Board** (Continued)

**Double Row, Vertical With Card Slots**

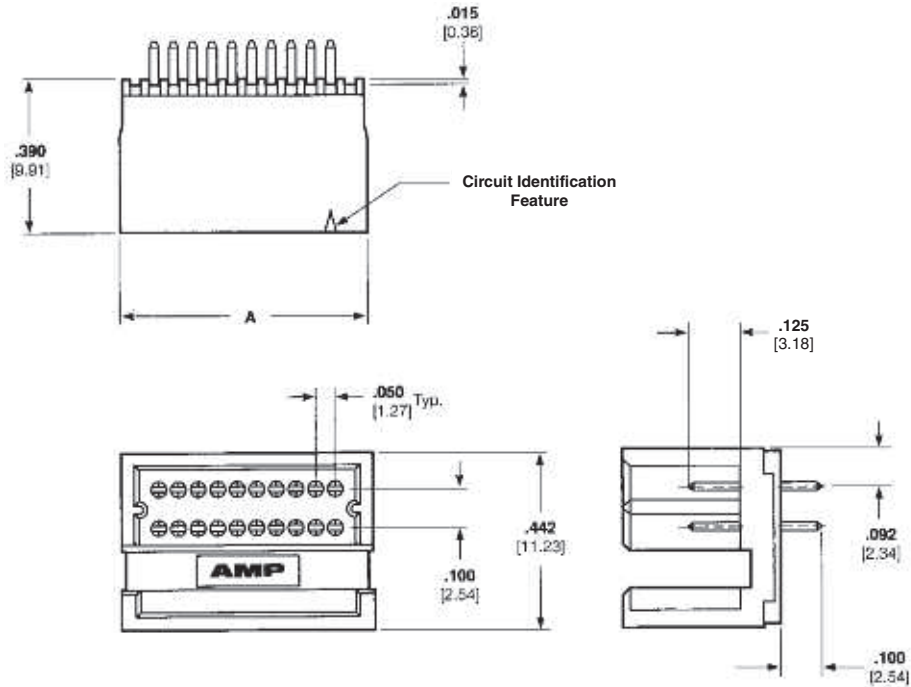
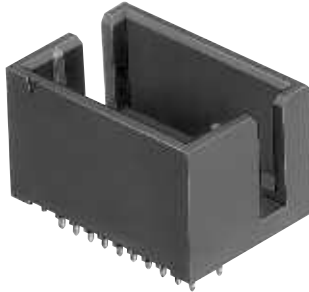

**Material and Finish**

**Housing** — Glass-filled thermoplastic, black, 94V-0 rated

**Contacts** — Copper alloy; duplex plated .000030 [0.00076] gold in mating area, .000150 [0.00381] tin on solder posts, with entire contact underplated .000050 [0.00127] nickel

**Related Product Data**

**Performance Specifications** — page 63

**Mateable Connectors** — page 39

**PC Board Hole Layout** — page 41

**Technical Documents** — page 64

**Product Specification** 108-1093

**Application Specification** 114-25031

No. of Pos.	Dimension A	Part Numbers
10	.394 [10.01]	5-104076-5
20	.644 [16.36]	5-104076-1
30	.894 [22.71]	5-104076-6
40	1.144 [29.06]	5-104076-3
50	1.394 [35.41]	5-104076-7
60	1.644 [41.76]	5-104076-2
80	2.144 [54.46]	5-104076-4
100	2.644 [67.16]	5-104076-8

**Note:** All part numbers are RoHS compliant.

## Thru-Hole Headers—Unshrouded, .050 x .100 [1.27 x 2.54] Centerline, Board-to-Board

### Single Row, Right-Angle

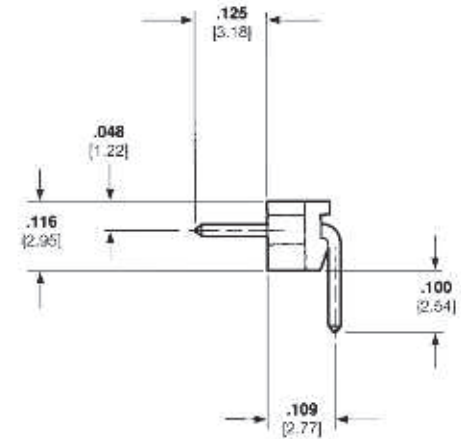
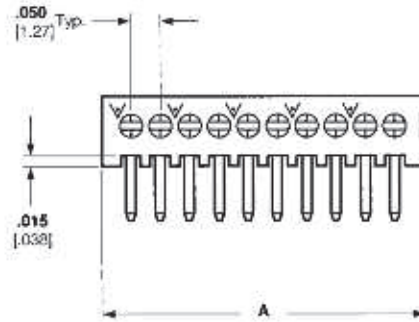
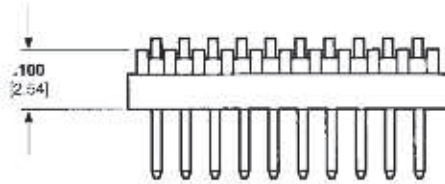
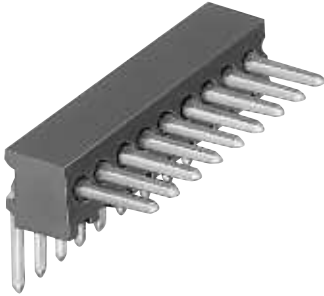

#### Material and Finish

**Housing** — Glass-filled thermoplastic, black, 94V-0 rated

**Contacts** — Copper alloy; duplex plated .000030 [0.00076] gold in mating area, .000150 [0.00381] tin on solder posts, with entire contact underplated .000050 [0.00127] nickel

#### Related Product Data

**Performance Characteristics** — page 63

**Mateable Connectors** — pages 37, 38, 49, & 50

**PC Board Hole Layout** — page 41

**Technical Documents** — page 64

**Product Specification** 108-1093

**Application Specification** 114-25031

No. of Pos.	Dimension A	Part Numbers
4	.215 [5.46]	5-104186-1
8	.415 [10.54]	5-104186-5
12	.615 [15.62]	5-104186-7
15	.765 [19.43]	5-104186-9
17	.865 [21.97]	6-104186-0
20	1.015 [25.78]	6-104186-1
25	1.265 [32.13]	6-104186-3
30	1.515 [38.48]	6-104186-5
31	1.565 [39.75]	7-104186-0
40	2.015 [51.18]	6-104186-7

**Note:** All part numbers are RoHS compliant.



## Thru-Hole Headers—Unshrouded, .050 x .100 [1.27 x 2.54] Centerline, Board-to-Board (Continued)

### Single Row, Vertical

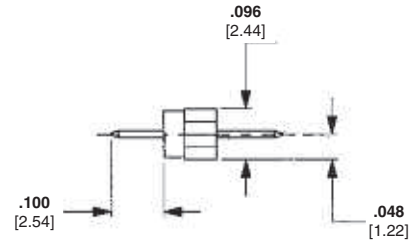
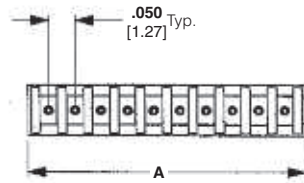
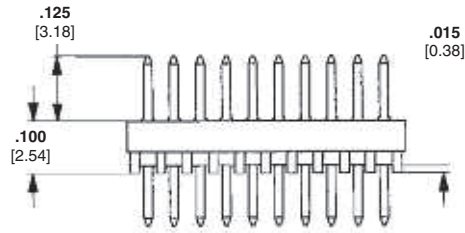
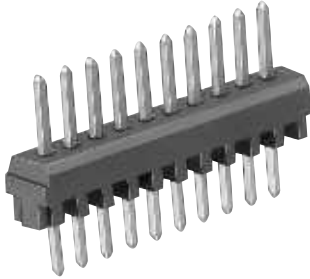

### Material and Finish

**Housing** — Glass-filled thermoplastic, black, 94V-0 rated

**Contacts** — Copper alloy; duplex plated .000030 [0.00076] gold in mating area, .000150 [0.00381] tin on solder posts, with entire contact underplated .000050 [0.00127] nickel

### Related Product Data

**Performance Specifications** — page 63

**Mateable Connectors** — pages 37, 38, 49, & 50

**Board-to-Board Spacing** — page 63

**PC Board Hole Layout** — page 41

**Technical Documents** — page 64

**Product Specification** 108-1093

**Application Specification** 114-25031

No. of Pos.	Dimension A	Part Numbers
4	.215 [5.46]	5-104178-1
6	.315 [8.00]	5-104178-3
8	.415 [10.54]	5-104178-5
10	.515 [13.08]	5-104178-6
20	1.015 [25.78]	6-104178-1
25	1.265 [32.13]	6-104178-3

**Note:** All part numbers are RoHS compliant.

**Thru-Hole Headers—Unshrouded, .050 x .100 [1.27 x 2.54] Centerline, Board-to-Board** (Continued)

**Double Row, Right-Angle**

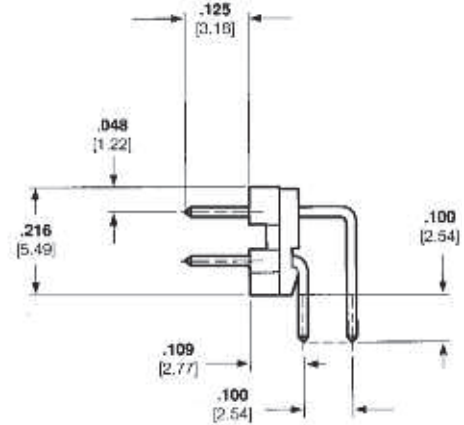
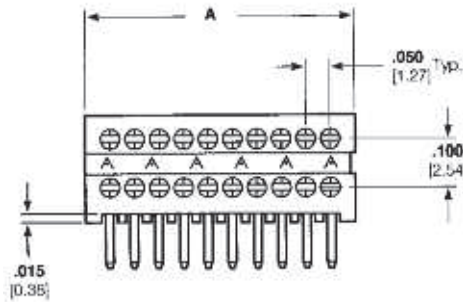
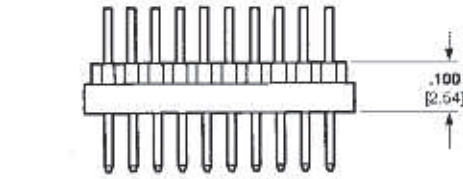
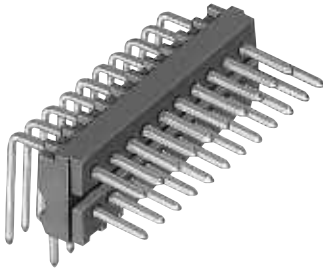

**Material and Finish**

**Housing** — Glass-filled thermoplastic, black, 94V-0 rated

**Contacts** — Copper alloy; duplex plated .000030 [0.00076] gold in mating area, .000150 [0.00381] tin on solder posts, with entire contact underplated .000050 [0.00127] nickel

**Related Product Data**

**Performance Specifications** — page 63

**Mateable Connectors** — pages 39, 40, 45, 51 & 52

**PC Board Hole Layout** — page 41

**Technical Documents** — page 64

**Product Specification** 108-1093

**Application Specification** 114-25031

No. of Pos.	Dimension A	Part Numbers
10	.265 [6.73]	5-104118-3
20	.515 [13.08]	5-104118-7
30	.765 [19.43]	6-104118-0
40	1.015 [25.78]	6-104118-2
50	1.265 [32.13]	5-104118-1
60	1.515 [38.48]	6-104118-4
80	2.015 [51.18]	6-104118-6
100	2.515 [63.88]	6-104118-7

**Note:** All part numbers are RoHS compliant.

3 Headers, Shrouded and Unshrouded

## Thru-Hole Headers—Unshrouded, .050 x .100 [1.27 x 2.54] Centerline, Board-to-Board (Continued)

### Double Row, Vertical

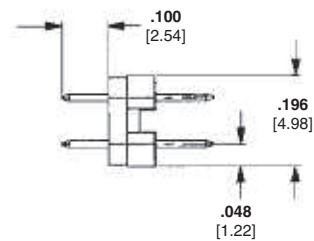
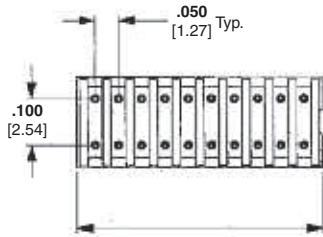
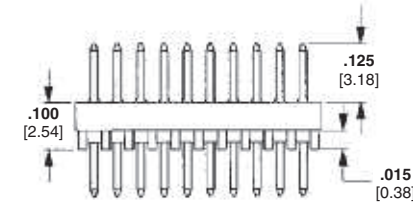
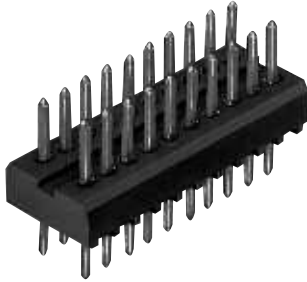

### Material and Finish

**Housing** — Glass-filled thermoplastic, black, 94V-0 rated

**Contacts** — Copper alloy; duplex plated .000030 [0.00076] gold in mating area, .000150 [0.00381] tin on solder posts, with entire contact underplated .000050 [0.00127] nickel

### Related Product Data

**Performance Characteristics** — page 63

**Mateable Connectors** — pages 39, 40, 45, 51, & 52

**Board-to-Board Spacing** — page 63

**PC Board Hole Layout** — page 42

**Technical Documents** — page 64

**Product Specification** 108-1093

**Application Specification** 114-25031

No. of Pos.	Dimension A	Part Numbers
8	.215 [5.46]	5-103916-3
20	.515 [13.08]	5-103916-2
30	.765 [19.43]	5-103916-9
36	.915 [23.24]	6-103916-8
40	1.015 [25.78]	6-103916-1
50	1.265 [32.13]	6-103916-3
60	1.515 [38.48]	6-103916-4
80	2.015 [51.18]	6-103916-6
100	2.515 [63.88]	6-103916-7

**Note:** All part numbers are RoHS compliant.

## Thru-Hole Receptacles, .050 x .100 [1.27 x 2.54] Centerline, Board-to-Board

### Product Facts

- High density; contacts spaced on .050 x .100 [1.27 x 2.54] centers
- Right-angle and vertical styles
- Single row; select sizes 5 thru 50 positions
- Double row; select sizes 10 thru 100 positions
- Contacts are selectively plated with gold
- Stand-offs for removal of solder flux

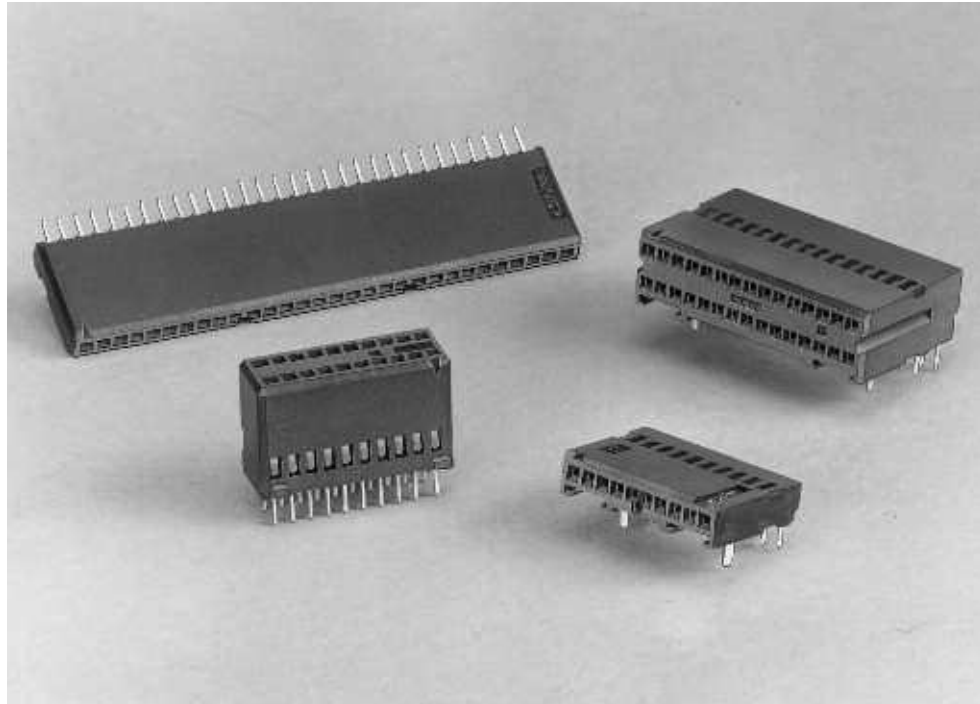

The AMPMODU System 50 thru-hole receptacles offer a wide variety of high density board-to-board connectors. The .050 [1.27] spacing between each contact provides an extremely dense interconnect package and results in a more efficient use of the printed circuit board space.

AMPMODU System 50 thru-hole receptacles are available in right-angle and vertical configurations and are composed of single and double row versions. The single row versions are available in select sizes of 5 thru 50 positions and double row in positions from 10 thru 100.

Receptacle contacts and mating .015 [0.38] square posts are formed from high conductivity copper alloy and are selectively plated with gold for higher performance and reliability. The receptacle housings are made of black thermoplastic, with a 94V-0 rating to withstand high temperatures of reflow soldering and incorporate stand-offs for free drainage of flux cleaning solutions.

## Thru-Hole Receptacles, .050 x .100 [1.27 x 2.54] Centerline, Board-to-Board (Continued)

### Single Row, Right-Angle With Solder Clips

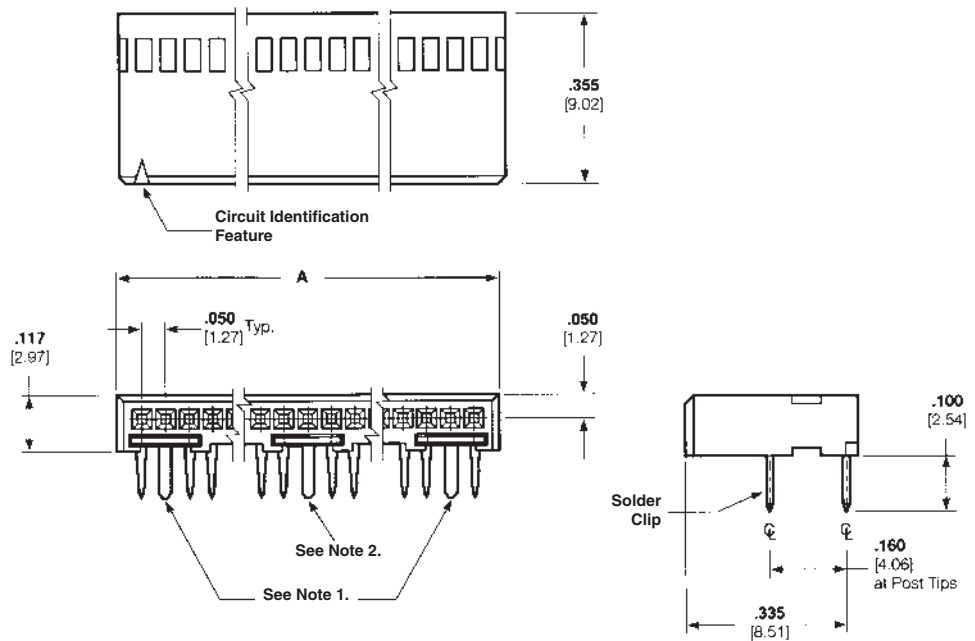

### Material and Finish

**Housing** — Glass-filled thermoplastic, black, 94V-0 rated

**Contacts** — Copper alloy; duplex plated .000030 [0.00076] gold in mating area, .000150 [0.00381] tin on solder posts, with entire contact underplated .000050 [0.00127] nickel

### Related Product Data

**Performance Specifications** — page 63

**Mateable Connectors** — pages 32 & 33

**PC Board Hole Layout** — page 41

**Technical Documents** — page 64

**Product Specification** 108-1093

**Application Specification** 114-25031

No. of Pos.	Dimension A	Part Numbers
10	.544 [13.82]	5-104196-2
15	.794 [20.17]	5-104196-4
20	1.044 [26.52]	5-104196-5

**Notes:**

- Solder Clips located as shown for 10 through 25 position receptacles.
- Solder Clips located as shown for 5 and 25 position receptacles.

**Note:** All part numbers are RoHS compliant.

**Thru-Hole Receptacles, .050 x .100 [1.27 x 2.54] Centerline, Board-to-Board** (Continued)

**Single Row, Vertical**

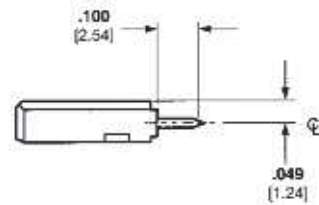
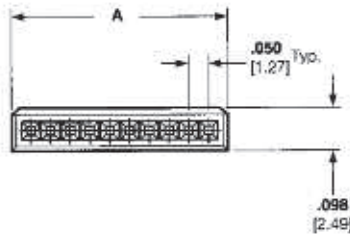
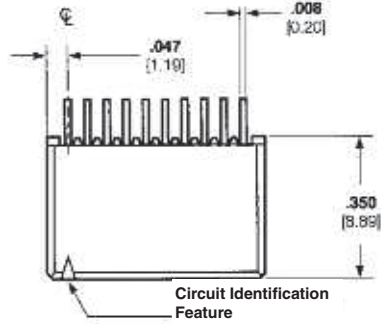
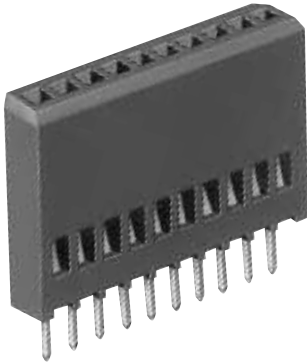

**Material and Finish**

**Housing** — Glass-filled thermoplastic, black, 94V-0 rated

**Contacts** — Copper alloy; duplex plated .000030 [0.00076] gold in mating area, .000150 [0.00381] tin on solder posts, with entire contact underplated .000050 [0.00127] nickel

**Related Product Data**

**Performance Specifications** — page 63

**Mateable Connectors** — pages 27, 28, 32, & 33

**Board-to-Board Spacing** — page 63

**PC Board Hole Layout** — page 41

**Technical Documents** — page 64

**Product Specification** 108-1093

**Application Specification** 114-25031

No. of Pos.	Dimension A	Part Numbers
10	.544 [13.82]	5-104192-2
12	.644 [16.35]	5-104192-3
15	.794 [20.17]	5-104192-4
20	1.044 [26.52]	5-104192-5
30	1.544 [39.22]	5-104192-7

**Note:** All part numbers are RoHS compliant.

## Thru-Hole Receptacles, .050 x .100 [1.27 x 2.54] Centerline, Board-to-Board (Continued)

### Double Row, Right-Angle

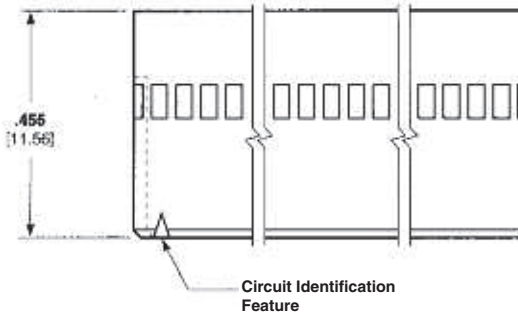
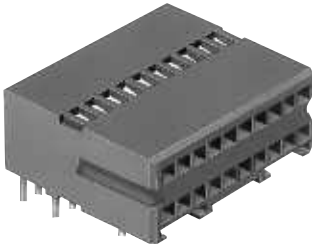

### Material and Finish

**Housing** — Glass-filled thermoplastic, black, 94V-0 rated

**Contacts** — Copper alloy; duplex plated .000030 [0.00076] gold in mating area, .000150 [0.00381] tin on solder posts, with entire contact underplated .000050 [0.00127] nickel

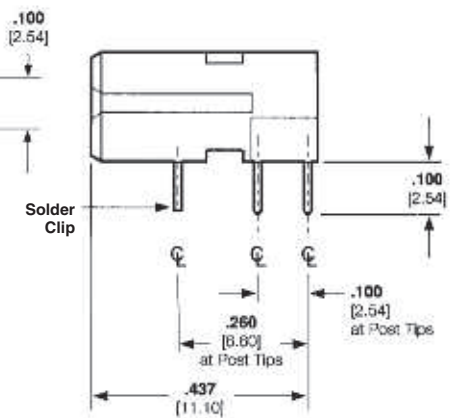
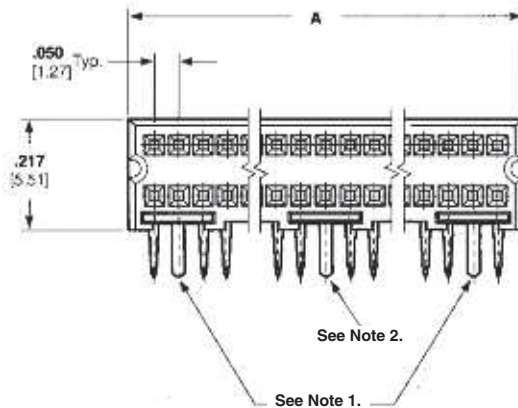

### Related Product Data

**Performance Characteristics** — page 63

**Mateable Connectors** — pages 31, 34 & 35

**PC Board Hole Layout** — page 41

**Technical Documents** — page 64

**Product Specification** 108-1093

**Application Specification** 114-25031

No. of Pos.	Dimension A	Part Numbers
10	.294 [7.47]	5-103911-1
20	.544 [13.82]	5-103911-2
30	.794 [20.17]	5-103911-7
40	1.044 [26.52]	5-103911-5
50	1.294 [32.87]	5-103911-4
60	1.544 [39.22]	5-103911-3
80	2.044 [51.92]	5-103911-6
100	2.544 [64.62]	5-103911-8

### Notes:

1. Solder Clips located as shown for 20 through 100 position receptacles.
2. Solder Clips located as shown for 10, 60, 80 and 100 position receptacles.

**Note:** All part numbers are RoHS compliant.

## Thru-Hole Receptacles, .050 x .100 [1.27 x 2.54] Centerline, Board-to-Board (Continued)

### Double Row, Vertical

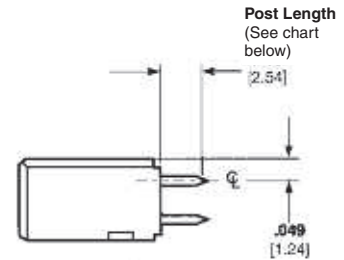
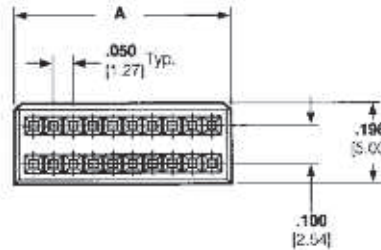
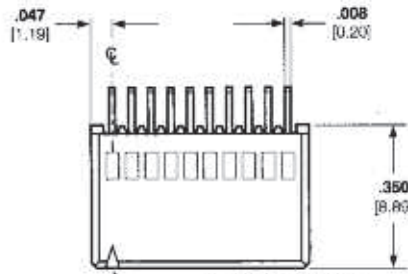
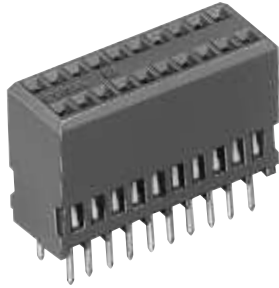

### Material and Finish

**Housing** — Glass-filled thermoplastic, black, 94V-0 rated

**Contacts** — Copper alloy; duplex plated .000030 [0.00076] gold in mating area, .000150 [0.00381] tin on solder posts, with entire contact underplated .000050 [0.00127] nickel

### Related Product Data

**Performance Specifications** — page 63

**Mateable Connectors** — pages 29, 30, 34, 35 & 44

**Board-to-Board Spacing** — page 63

**PC Board Hole Layout** — page 41

### Technical Documents — page 64

**Product Specification** 108-1093

**Application Specification**

114-25031

No. of Pos.	Dimension A	Part Numbers Post Length	
		.100 [2.54]	.145 [3.68]
10	.294 [7.47]	5-104078-3	—
20	.544 [13.82]	5-104078-1	—
24	.644 [16.36]	5-104078-9	—
30	.794 [20.17]	5-104078-4	—
34	.894 [22.71]	6-104078-0	—
40	1.044 [26.52]	5-104078-2	—
50	1.294 [32.87]	5-104078-5	5-104744-7
60	1.544 [39.22]	5-104078-6	—
68	1.744 [44.30]	6-104078-3	—
80	2.044 [51.92]	5-104078-7	5-104744-4
100	2.544 [64.62]	5-104078-8	5-104744-5

**Note:** All part numbers are RoHS compliant.



## Recommended PC Board Hole Layouts, Thru-Hole Board-to-Board Connectors

### Single Row, Right-Angle with Solder Clips

**Note:** Consult TE for customer drawings detailing tolerances.

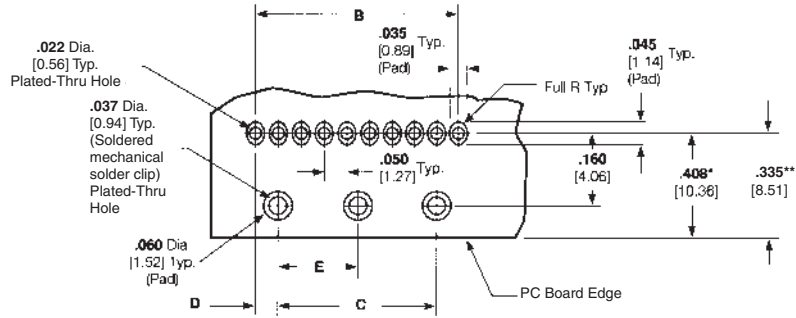

\* This dimension is for Shrouded, Single Row Right-Angle Headers only.

\*\* This dimension is for Single Row Right-Angle Receptacles only.

No. of Pos.	Dimensions			
	B	C	D	E
4	.150 [3.81]	—	.075 [1.91]	—
5	.200 [5.08]	—	.100 [2.54]	—
6	.250 [6.35]	—	.125 [3.18]	—
8	.350 [8.89]	—	.175 [4.45]	—
10	.450 [11.43]	.350 [8.89]	.050 [1.27]	—
12	.550 [13.97]	.450 [11.43]	.050 [1.27]	—
15	.700 [17.78]	.600 [15.24]	.050 [1.27]	—
20	.950 [24.13]	.850 [21.59]	.050 [1.27]	—
22	1.050 [26.67]	.950 [24.13]	.050 [1.27]	—
25	1.200 [30.48]	1.100 [27.94]	.050 [1.27]	—
28	1.350 [34.29]	1.250 [31.75]	.050 [1.27]	.625 [15.88]
30	1.450 [36.83]	1.350 [34.29]	.050 [1.27]	.675 [17.15]
36	1.750 [44.45]	1.650 [41.91]	.050 [1.27]	.825 [20.96]
40	1.950 [49.53]	1.850 [46.99]	.050 [1.27]	.925 [23.50]
45	2.200 [55.88]	2.100 [53.34]	.050 [1.27]	1.050 [26.67]
50	2.450 [62.23]	2.350 [59.69]	.050 [1.27]	1.175 [29.85]

### Double Row, Right-Angle with Solder Clips

**Note:** Consult TE for customer drawings detailing tolerances.

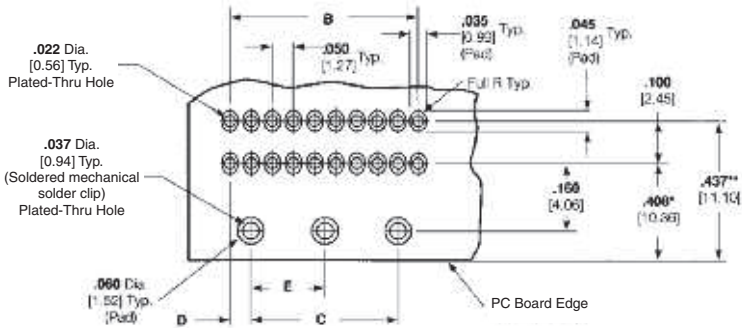

\* This dimension is for Shrouded, Double Row Right-Angle Headers only.

\*\* This dimension is for Double Row Right-Angle Receptacles only.

No. of Pos.	Dimensions			
	B	C	D	E
10	.200 [5.08]	—	.100 [2.54]	—
20	.450 [11.43]	.350 [8.89]	.050 [1.27]	—
24	.550 [13.97]	.450 [11.43]	.050 [1.27]	—
26	.600 [15.24]	.500 [12.70]	.050 [1.27]	—
30	.700 [17.78]	.600 [15.24]	.050 [1.27]	—
34	.800 [20.32]	.700 [17.78]	.050 [1.27]	—
40	.950 [24.13]	.850 [21.59]	.050 [1.27]	—
50	1.200 [30.48]	1.100 [27.94]	.050 [1.27]	—
60	1.450 [36.83]	1.350 [34.29]	.050 [1.27]	.675 [17.15]
68	1.650 [41.91]	1.550 [39.37]	.050 [1.27]	.775 [19.69]
72	1.750 [44.45]	1.650 [41.91]	.050 [1.27]	.825 [20.96]
80	1.950 [49.53]	1.850 [46.99]	.050 [1.27]	.925 [23.50]
100	2.450 [62.23]	2.350 [59.69]	.050 [1.27]	1.175 [29.85]

## Recommended PC Board Hole Layouts, Thru-Hole Board-to-Board Connectors (Continued)

### Single Row Without Solder Clips

Note: Consult TE for customer drawings detailing tolerances.

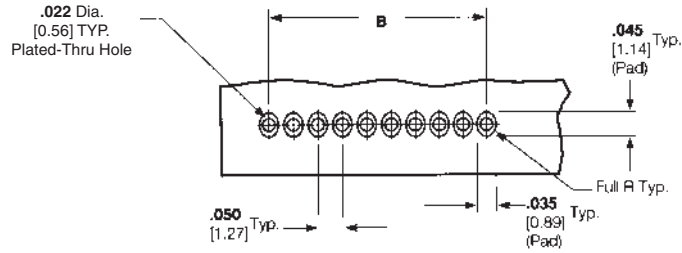

No. of Pos.	Dimension B
4	.150 [3.81]
5	.200 [5.08]
6	.250 [6.35]
8	.350 [8.89]
10	.450 [11.43]
12	.550 [13.97]
13	.600 [15.24]
15	.700 [17.78]

No. of Pos.	Dimension B
17	.800 [20.32]
20	.950 [24.13]
22	1.050 [26.67]
25	1.200 [30.48]
30	1.450 [36.83]
31	1.500 [38.10]
36	1.750 [44.45]
40	1.950 [49.53]
50	2.450 [62.23]

### Double Row Without Solder Clips

Note: Consult TE for customer drawings detailing tolerances.

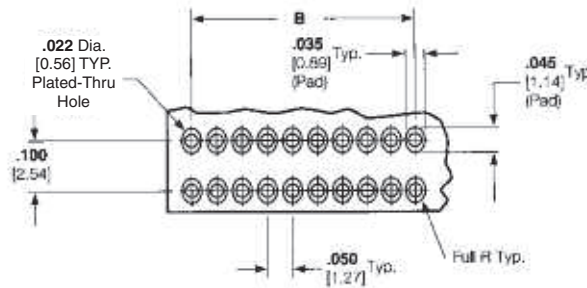

No. of Pos.	Dimension B
8	.150 [3.81]
10	.200 [5.08]
12	.250 [6.35]
14	.300 [7.62]
16	.350 [8.89]
20	.450 [11.43]
24	.550 [13.97]
26	.600 [15.24]
30	.700 [17.78]
34	.800 [20.32]

No. of Pos.	Dimension B
36	.850 [21.59]
40	.950 [24.13]
44	1.050 [26.67]
50	1.200 [30.48]
60	1.450 [36.83]
68	1.650 [41.91]
72	1.750 [44.45]
80	1.950 [49.53]
100	2.450 [62.23]

## Surface-Mount Connectors, .050 x .100 [1.27 x 2.54] Centerline, Board-to-Board

### Product Facts

- Surface-mount option for parallel board-to-board applications; completely intermateable with AMPMODU System 50 thru-hole board-to-board and cable-to-board systems
- Double row, vertical, shrouded header and receptacle assemblies
- Available in select sizes from 10 through 100 positions
- High Density; contacts spaced on .050 x .100 [1.27 x 2.54] centers; compact footprint
- Compatible with standard surface-mount processes
- Stand-offs for free drainage of flux cleaning solutions; visible solder joints for easy inspection
- Simple, low insertion-force holddown for process retention and long-term strain relief for solder joints
- Available in tape and reel packaging (with vacuum covers) for automatic placement.

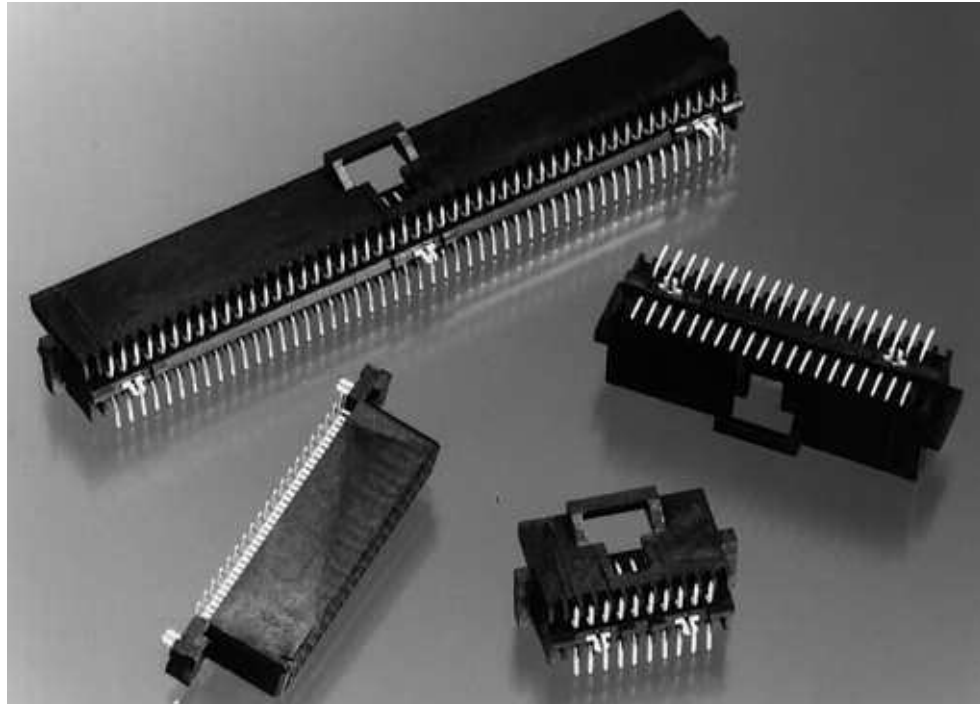

The high-density surface-mount connector is another mounting option in the AMPMODU System 50 connector family.

This surface-mount system is fully intermateable with the AMPMODU System 50 thru-hole and cable-to-board connectors.

Additionally, the design of the mating interface has not been changed, maintaining the same high reliability as the thru-hole product.

The surface-mount system includes double row, vertical, shrouded header and receptacle assemblies in select sizes from 10 through 100 positions. It meets the tight dimensional requirements of surface-mount technology. The simple, low insertion-force holddown provides both processing retention and long-term strain relief for the solder joints in the headers and receptacles.

## Surface-Mount Headers, .050 x .100 [1.27 x 2.54] Centerline, Board-to-Board

### Double Row, Vertical

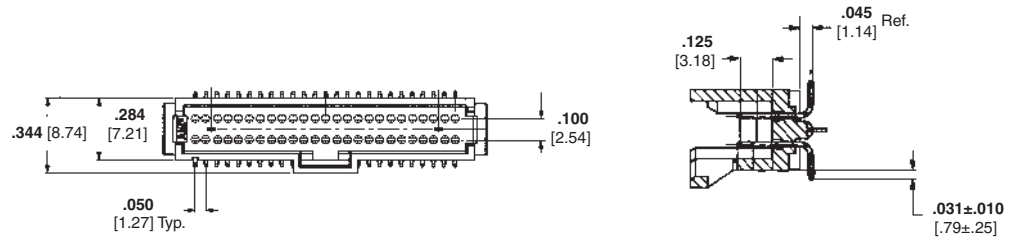
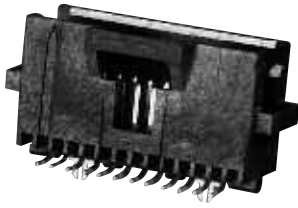

### Material and Finish

**Housing** — Glass-filled thermoplastic, black, 94V-0 rated

**Contacts** — Copper alloy; duplex plated .000030 [0.00076] gold in mating area, .000150 [0.00381] tin on solder tail, with entire contact under-plated .000050 [0.00127] nickel

**Holddown** — Copper alloy, plated .000150 [0.00381] tin over .000050 [0.00127] nickel

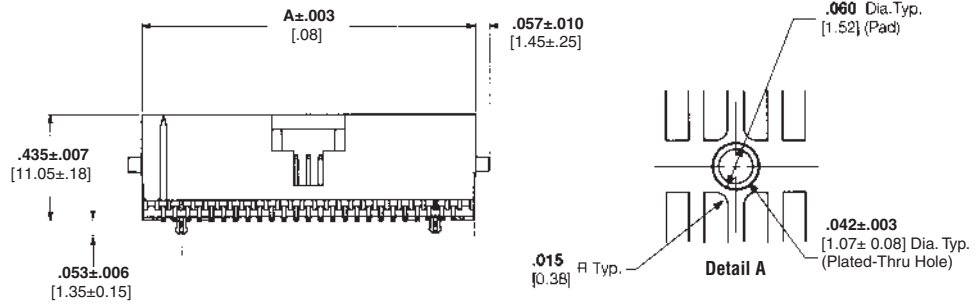

### Related Product Data

**Performance Characteristics** — page 63

**Mateable Connectors** — pages 40, 45, 51, 52, & 56

**Board-to-Board Spacing** — page 63

**Technical Documents** — page 64

**Product Specification** 108-1093

**Application Specification** 114-25035

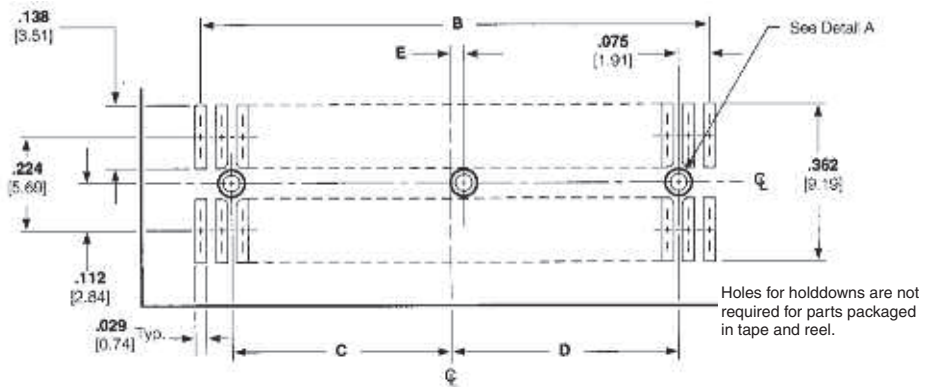

Recommended PC Board Layout

No. of Pos.	Dimensions					Part Numbers	
	A	B	C	D	E	Pkg in Tube	Pkg in Tape & Reel*
10	.380 [9.65]	.200 [5.08]	—	.025 [0.64]	—	5-104549-1	5-147377-1
12	.430 [10.92]	.250 [6.35]	—	—	—	6-104549-1	—
20	.630 [16.00]	.450 [11.43]	.150 [3.81]	.150 [3.81]	—	5-104549-2	5-147377-2
24	.730 [18.54]	.550 [13.97]	.200 [5.08]	.200 [5.08]	—	5-104549-3	5-147377-9
30	.880 [22.35]	.700 [17.78]	.275 [6.99]	.275 [6.99]	—	5-104549-5	5-147377-3
40	1.130 [28.70]	.950 [24.13]	.400 [10.16]	.400 [10.16]	—	5-104549-6	5-147377-4
50	1.380 [35.05]	1.200 [30.48]	.525 [13.34]	.525 [13.34]	.025 [0.64]	5-104549-7	5-147377-5
60	1.630 [41.40]	1.450 [36.83]	.650 [16.51]	.650 [16.51]	.000	5-104549-8	5-147377-6
80	2.130 [54.10]	1.950 [49.53]	.900 [22.86]	.900 [22.86]	.000	5-104549-9	5-147377-7
100	2.630 [66.80]	2.450 [62.23]	1.150 [29.21]	1.150 [29.21]	.000	6-104549-0	5-147377-8

\*Parts packaged in tape and reel are without hold downs and include a vacuum pick and place cover

**Note:** All part numbers are RoHS compliant.

## Surface-Mount Receptacles, .050 x .100 [1.27 x 2.54] Centerline, Board-to-Board

### Double Row, Vertical

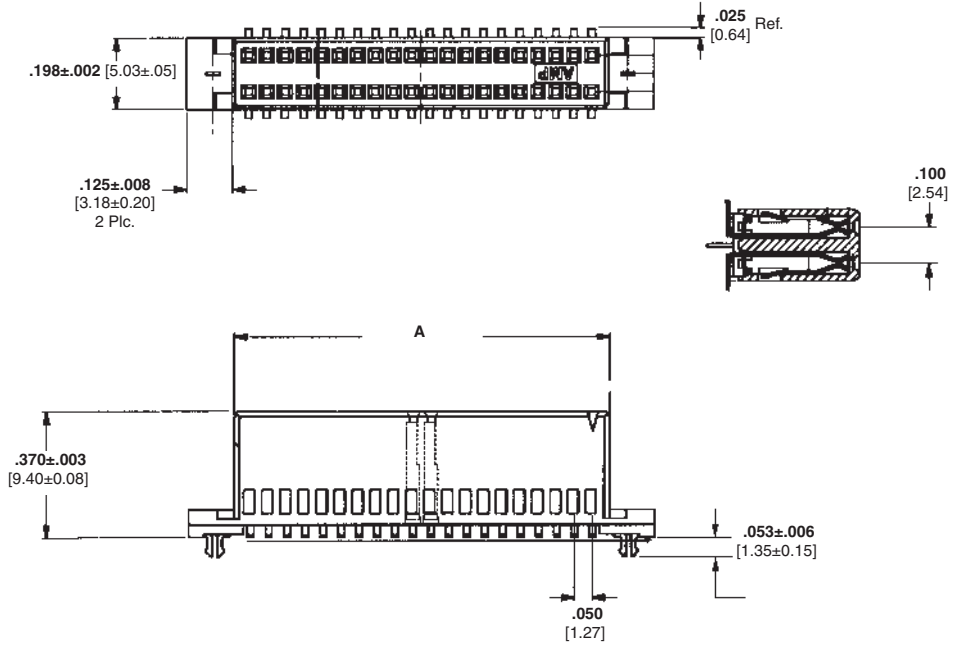

### Material and Finish

**Housing** — Glass-filled thermoplastic, black, 94V-0 rated

**Contacts** — Phosphor bronze; duplex plated .000030 [0.00076] gold in mating area, .000150 [0.00381] tin on solder tail, with entire contact underplated .000050 [0.00127] nickel

**Holddown** — Copper alloy; duplex plated .000150 [0.00381] tin over .000050 [0.00127] nickel

### Related Product Data

**Performance Characteristics** — page 63

**Mateable Connectors** — pages 29, 30, 34, 35 & 44

**Board-to-Board Spacing** — page 63

**Technical Documents** — page 64

**Product Specification** 108-1093

**Application Specification** 114-25035

Recommended PC Board Layout

No. of Pos.	Dimensions			Part Numbers	
	A	B	C	Pkg in Tube	Pkg in Tape & Reel*
10	.294 [7.47]	.200 [5.08]	.400 [10.16]	5-104550-1	5-147378-1
20	.544 [13.82]	.450 [11.43]	.650 [16.51]	5-104550-2	5-147378-2
24	.644 [16.36]	.550 [13.97]	.750 [19.05]	5-104550-3	5-147378-9
30	.794 [20.17]	.700 [17.78]	.900 [22.86]	5-104550-4	5-147378-3
40	1.044 [26.52]	.950 [24.13]	1.150 [29.21]	5-104550-5	5-147378-4
50	1.294 [32.87]	1.200 [30.48]	1.400 [35.56]	5-104550-6	5-147378-5
60	1.544 [39.22]	1.450 [36.83]	1.650 [41.91]	5-104550-7	5-147378-6
80	2.044 [51.92]	1.950 [49.53]	2.150 [54.61]	5-104550-8	5-147378-7
100	2.544 [64.62]	2.450 [62.23]	2.650 [67.31]	5-104550-9	5-147378-8

\*Parts packaged in tape and reel are without hold downs and include a vacuum pick and place cover

**Note:** All part numbers are RoHS compliant.

## Cable-to-Board Connectors, .050 x .100 [1.27 x 2.54] Centerline FFC Cable

### Product Facts

- Signal application only, 1.5 amperes maximum single circuit
- Single or double row connectors
- Terminates flexible flat conductor cable and flexible etched circuitry
- Shielded cable provides for customizing
- Center latch housing providing positive latching

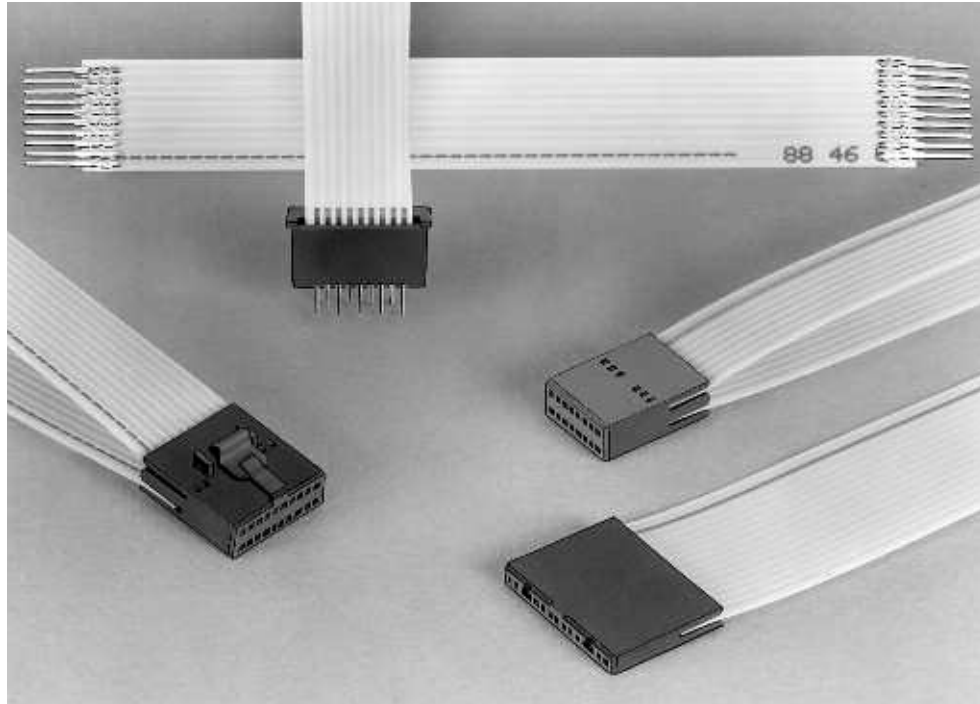

The cable-to-board .050 [1.27] center FFC receptacle connectors are part of the AMPMODU System 50 family for terminating flexible flat conductor cable and flexible etched circuitry.

The FFC receptacle uses a dual beam contact with 30 microinches of gold plating. The FFC receptacle connectors have an integral latch for positive locking to shrouded mating headers.

Flexible flat conductor cable is a planar parallel conductor cable. It can be used as a one-to-one connector or as a complex harness, allowing split-outs and special routing. The cable is comprised of .026 [0.66] wide x .003 [0.08] thick conductors made of copper per QQ-C-502 and insulated with a flame retardant polyester film.

The FFC contacts are available in receptacle and

solder tab. Receptacle contacts are made of phosphor bronze with a finish of plated gold duplex, while the solder tab contacts are finished in a bright tin-lead overall.

The complete product line provides solder tabs for board mounting at low cost and custom shielding of the cable.

**Cable-to-Board Connectors, .050 x .100 [1.27 x 2.54] Centerline FFC Cable]** (Continued)

**Custom Designed Cable Assemblies**

TE can supply customized flexible flat conductor cable assemblies using the components shown on pages 48 thru 54. Typical examples of these cable assemblies are shown to the right.

And, to meet the internal shielding requirements of today's complex electronic equipment, custom designed shielded FFC cable assemblies can be made to your specific specifications.

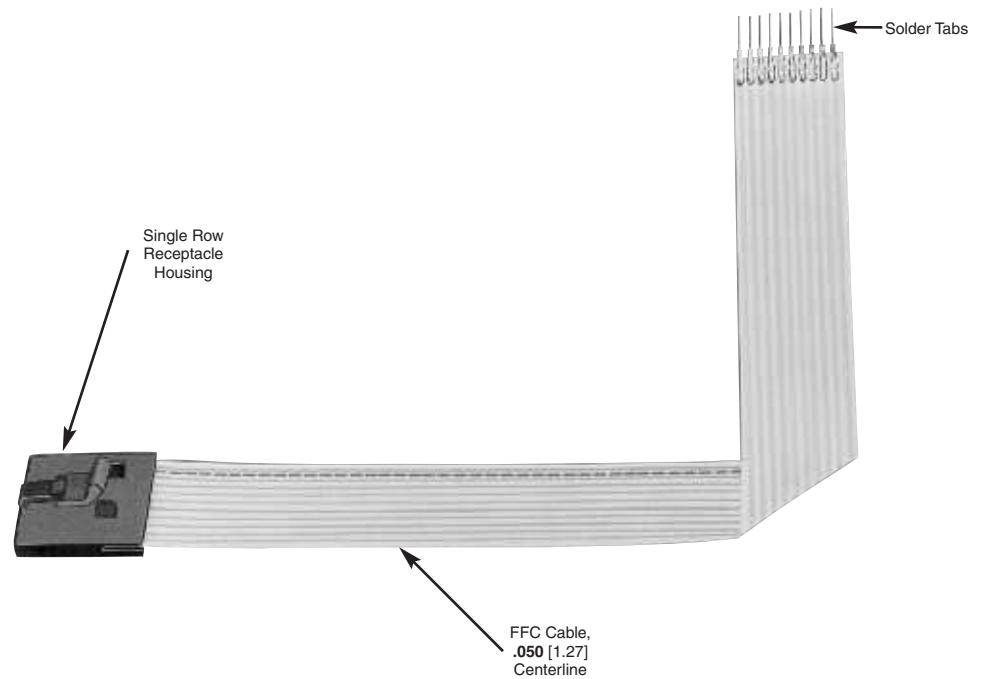
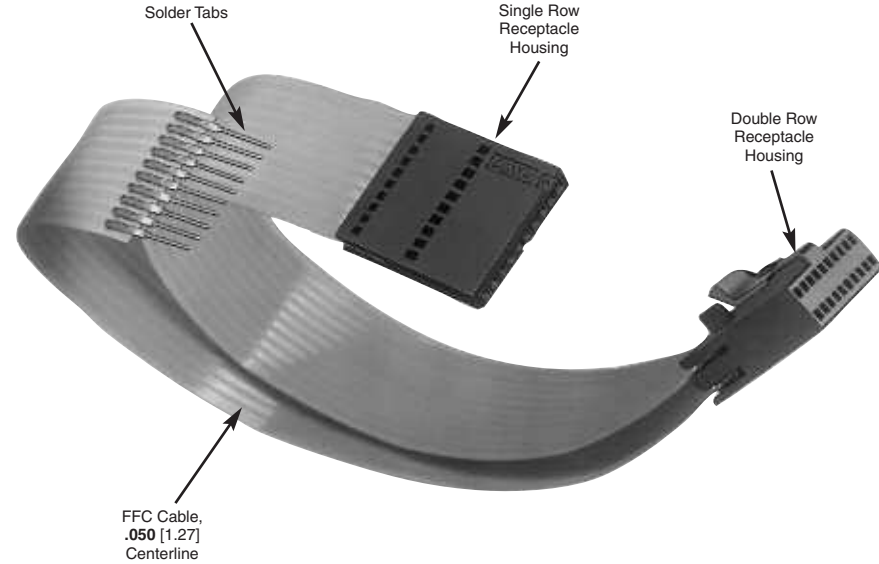

**FFC Contacts, .050 x .100 [1.27 x 2.54] Centerline**

Receptacle Strip

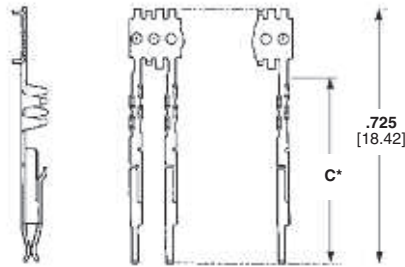

Solder Tab Strip

**Receptacle**

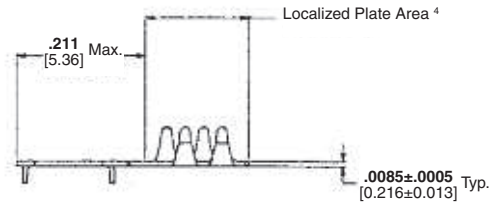
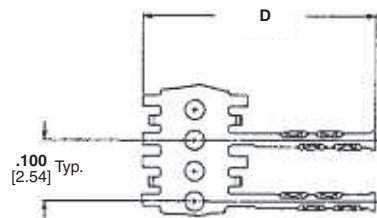
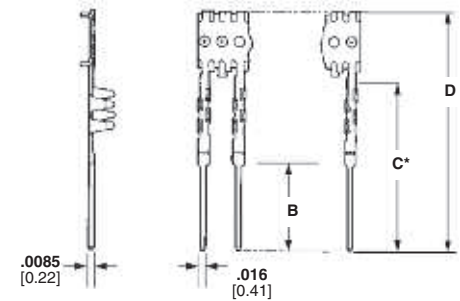
 Accepts .015 [0.38] Sq. Post  
 .125-.350 [3.18-8.89] Long

**Solder Tab**

**Material and Finish**

Phosphor bronze; plated gold duplex or bright tin-lead overall (See chart.)

**Related Product Data**
**Performance Characteristics** — page 63

**Housings** — pages 49-52

**Application Tooling** — page 60-62

**Technical Documents** — page 64

**Product Specification** 108-16022

**Application Specification**  
 114-16008

Type	Config.	Contacts Part No./Finish	Dimensions			Application Tooling Part Numbers	
			B	C*	D	Machine	Machine With Programmer
Receptacle	Strip	1-487547-1 <sup>1</sup>	—	.520 [13.21]	.725 [18.42]		
	Strip	487923-4 <sup>2</sup>	.245 [6.22]	.480 [12.19]	.685 [17.40]		
Solder Tab	Strip	487923-5 <sup>3</sup>	.245 [6.22]	.480 [12.19]	.685 [17.40]	224910-4 (120 V)	318619-4 (120 V)
	Strip	487940-4 <sup>2</sup>	.110 [2.79]	.345 [8.76]	.550 [13.97]	224910-6 (240 V)	318619-6 (240 V)
Contact Splice	Strip	487941-4 <sup>4</sup>	—	—	.385 [9.78]		
Receptacle	Strip	1-487547-2 <sup>5</sup>	—	.520 [13.21]	.725 [18.42]		

<sup>1</sup>Duplex plated .000030 [0.00076] gold on mating area, .000100 [0.00254] min. bright tin in crimp area, with entire contact underplated .000050 [0.00127] min. nickel.

<sup>2</sup>Plated .000100 [0.00254] min. tin over .000050 [0.00127] min. nickel.

<sup>3</sup>Duplex plated .000015 [0.00038] gold on solder tab end, .000100 [0.00254] min. bright tin in crimp area, with entire contact underplated .000050 [0.00127] min. nickel.

<sup>4</sup>Plated .000150 [3.81µm] min. bright tin over .000050 [1.27µm] min. nickel.

<sup>5</sup>Duplex Plated .000150 [0.00038] gold on mating area, .000100 [0.00254] min bright tin in crimp area, with entire contact underplated .000050 [0.00127] min. nickel.

<sup>\*</sup>After cut-off from carrier strip.

**Note:** All part numbers are RoHS compliant.



## Single Row Receptacle Housings, .050 x .100 [1.27 x 2.54] Centerline, Cable-to-Board



Plain Style Housings



Latch Style Housings

### Material and Finish

**Housing** — Black thermoplastic, flame retardant, 94V-0 rated

### Related Product Data

**Performance Characteristics** — page 63

**Receptacle Contacts** — page 48

**Mateable Headers** — pages 27, 28, 32 & 33

**Technical Documents** — page 64

**Product Specification** 108-16022

**Application Specification** 114-16008

### Plain Style Housings

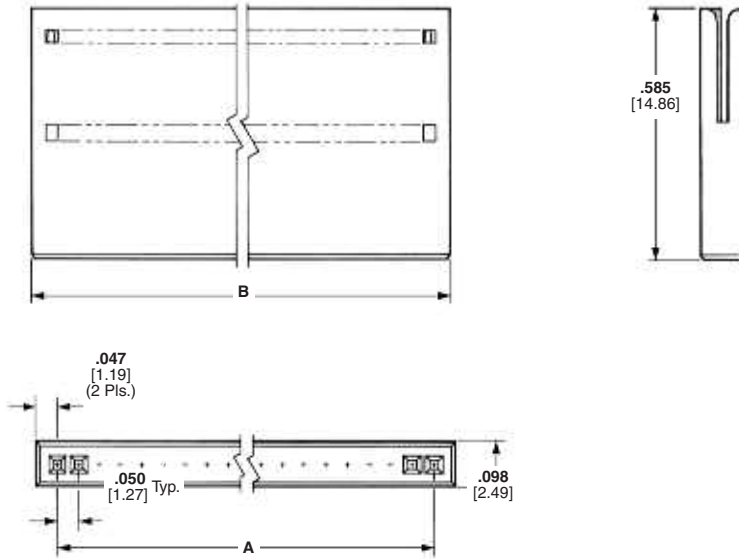

### Latch Style Housings

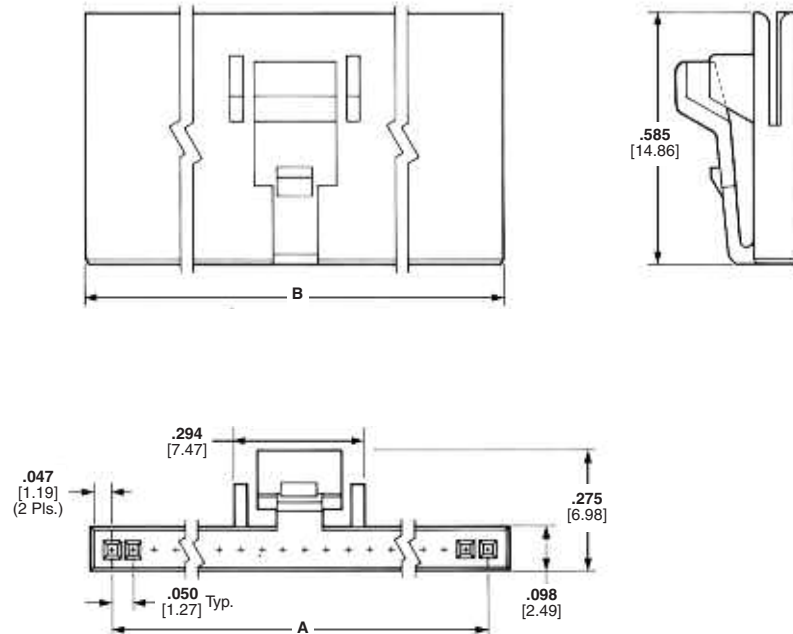

### Single Row Receptacle Housings, .050 x .100 [1.27 x 2.54] Centerline, Cable-to-Board (Continued)

Receptacle Housings

3

No. of Pos.	Dimensions		Part Numbers	
	A	B	Plain Receptacle Housing	Latch Style Receptacle Housing
4	.150 [3.18]	.244 [6.20]	487544-1	487545-1
5	.200 [5.08]	.294 [7.47]	487544-2	487545-2
6	.250 [6.35]	.344 [8.74]	487544-3	487545-3
7	.300 [7.62]	.394 [10.01]	487544-4	487545-4
8	.350 [8.89]	.444 [11.28]	487544-5	487545-5
10	.450 [11.43]	.544 [13.82]	487544-7	487545-7
12	.550 [13.97]	.644 [16.36]	487544-9	487545-9
13	.600 [15.24]	.694 [17.63]	—	1-487545-0
15	.700 [17.78]	.794 [20.17]	1-487544-2	1-487545-2
16	.750 [19.05]	.844 [21.44]	1-487544-3	—
17	.800 [20.32]	.894 [22.71]	1-487544-4	1-487545-4
20	.950 [24.13]	1.044 [26.52]	1-487544-7	1-487545-7
22	1.050 [26.67]	1.144 [29.06]	1-487544-9	1-487545-9
25	1.200 [30.48]	1.294 [32.87]	2-487544-2	2-487545-2
26	1.250 [31.75]	1.343 [34.11]	—	2-487545-3
28	1.350 [34.29]	1.443 [36.65]	—	2-487545-5
30	1.450 [36.83]	1.544 [39.22]	—	2-487545-7
36	1.750 [44.45]	1.844 [46.84]	3-487544-3	3-487545-3
40	1.950 [49.53]	2.044 [51.92]	—	3-487545-7
45	2.200 [55.88]	2.294 [58.27]	—	4-487545-2
50	2.450 [62.23]	2.544 [64.62]	4-487544-7	4-487545-7

**Note:** Other sizes of receptacle housings (plain and latch style) can be made available, consult TE.

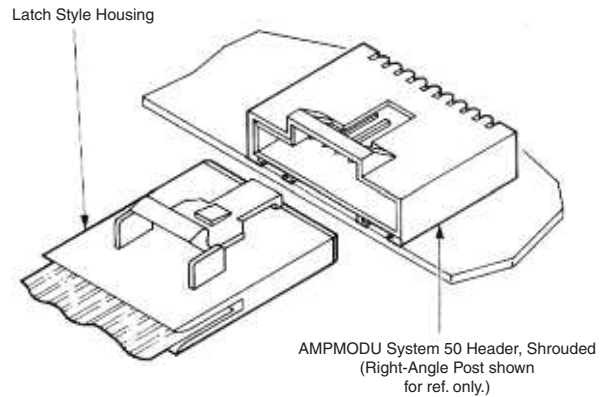
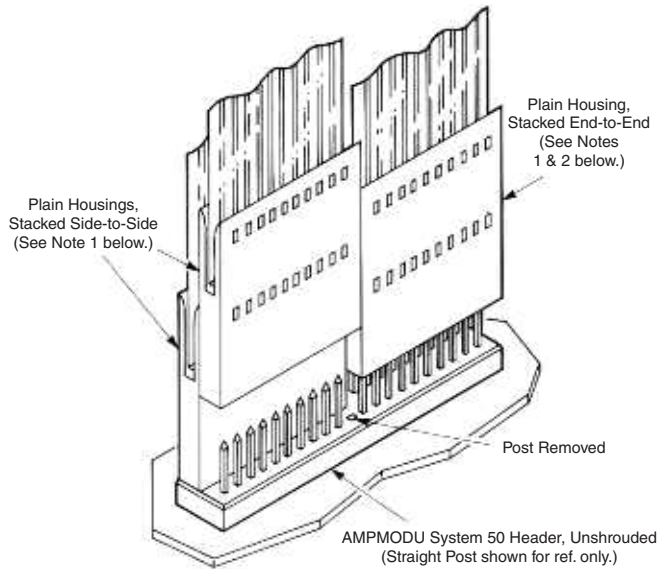

- Notes:**
1. Plain housings are side-to-side stackable on either straight or right-angle posted, unshrouded AMPMODU System 50 headers.
  2. For end-to-end stacking, the posts located between the adjoining housings must be removed to provide housing end clearance.

**Typical Cable-to-Board Application of Plain Receptacle Housing**

**Typical Cable-to-Board Application of Latch Style Receptacle Housing**

**Note:** All part numbers are RoHS compliant.

## Double Row Receptacle Housings, .050 x .100 [1.27 x 2.54] Centerline, Cable-to-Board



Plain Style Housings



Latch Style Housings

### Plain Style Housings

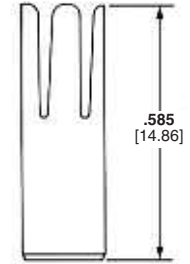
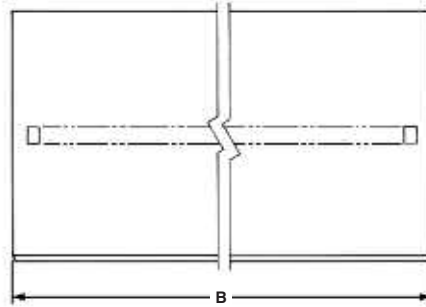

Plain

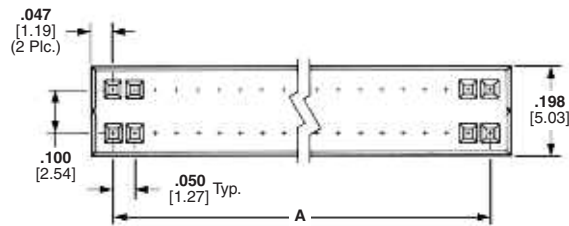

### Material

Black thermoplastic, flame retardant, 94V-0 rated

### Related Product Data

**Performance Characteristics** — page 63

**Receptacle Contacts** — page 48

**Mateable Headers** — pages 29, 30, 34, 35, & 44

### Latch Style Housings

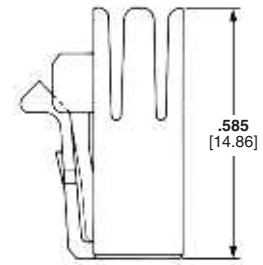
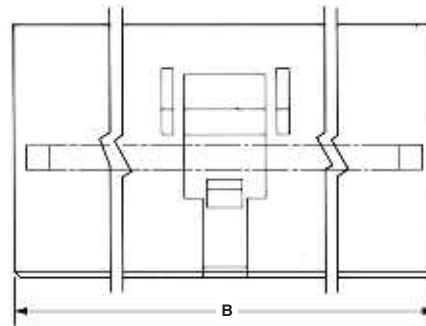

Latch

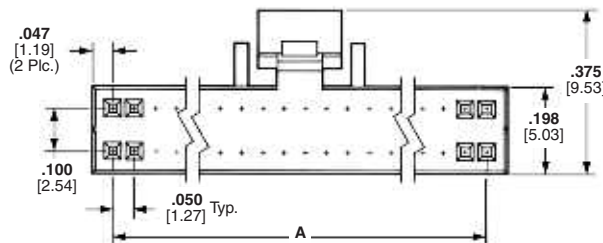

**Technical Documents** — page 64

**Product Specification** 108-16022

**Application Specification** 114-16008

## Double Row Receptacle Housings, .050 x .100 [1.27 x 2.54] Centerline, Cable-to-Board (Continued)

No. of Pos.	Dimensions		Plain Housing Part Numbers	Latch Style Housing Part Numbers
	A	B		
8	.150 [3.81]	.247 [6.27]	487938-8	487937-8
10	.200 [5.08]	.297 [7.54]	1-487938-0	1-487937-0
12	.250 [6.35]	.374 [8.81]	1-487938-2	1-487937-2
14	.300 [7.62]	.397 [10.08]	1-487938-4	1-487937-4
16	.350 [8.89]	.447 [11.35]	1-487938-6	1-487937-6
20	.450 [11.43]	.547 [13.89]	2-487938-0	2-487937-0
24	.550 [13.97]	.647 [16.43]	2-487938-4	2-487937-4
26	.600 [15.24]	.697 [17.7]	2-487938-6	2-487937-6
30	.700 [17.78]	.797 [20.24]	3-487938-0	3-487937-0
34	.800 [20.32]	.897 [22.78]	3-487938-4	3-487937-4
40	.950 [24.13]	1.047 [26.59]	4-487938-0	4-487937-0
44	1.050 [26.67]	1.147 [29.13]	4-487938-4	4-487937-4
50	1.200 [30.48]	1.297 [39.94]	5-487938-0	5-487937-0
60	1.450 [36.83]	1.547 [39.29]	—	6-487937-0
72	1.750 [44.45]	1.847 [46.91]	7-487938-2	7-487937-2
80	1.950 [49.53]	2.047 [51.99]	8-487938-0	8-487937-0
100	2.450 [62.23]	2.547 [64.69]	487938-1	487937-1

**Note:** Other sizes of receptacle housings, up to 120 positions, can be made available, consult TE.

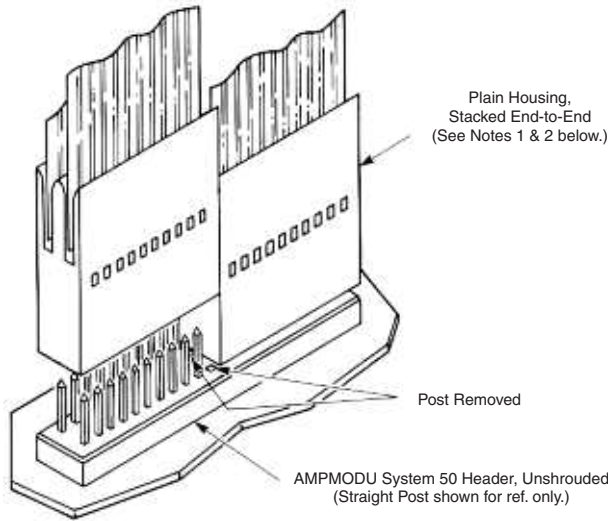

- Notes:**
1. Plain housings are end-to-end stackable on either straight or right-angle posted, unshrouded AMPMODU System 50 headers.
  2. For end-to-end stacking, the two posts located between the adjoining housings must be removed to provide housing end clearance.

**Typical Cable-to-Board Application of Plain Receptacle Housing**

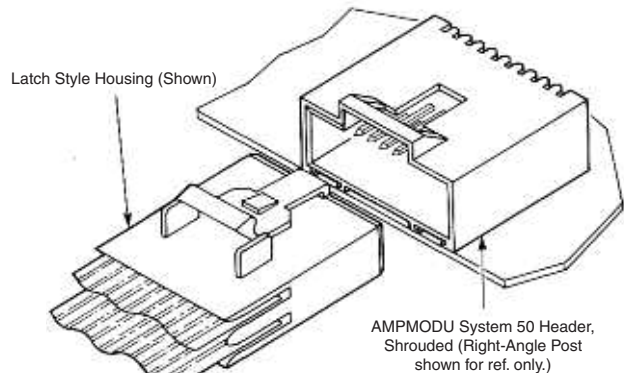

**Typical Cable-to-Board Application of Latch Style Receptacle Housing**

**Note:** All part numbers are RoHS compliant.

## ZIF-Line Connectors, .050 x .100 [1.27 x 2.54] Centerline, Cable-to-Board

### Vertical Cable Entry



### Material and Finish

**Housing and Cover** — Black thermoplastic, flame retardant, 94V-0 rated

**Contacts** — Phosphor bronze, plated .000150 [0.00381] min. bright tin over .000050 [0.00127] min. nickel on entire contact

### Performance Characteristic

**Contact Current Rating** — 1 ampere†

†1 ampere rating is for single circuit. Multiple circuits, ambient temperature and conductor size affect current carrying capacity.

### Related Product Data

**FFC Cable (with Tin-Plated Prepared Ends)** — Consult TE.

**Technical Documents** — page 64

**Product Specification** 108-16025

**Application Specification** 114-16014

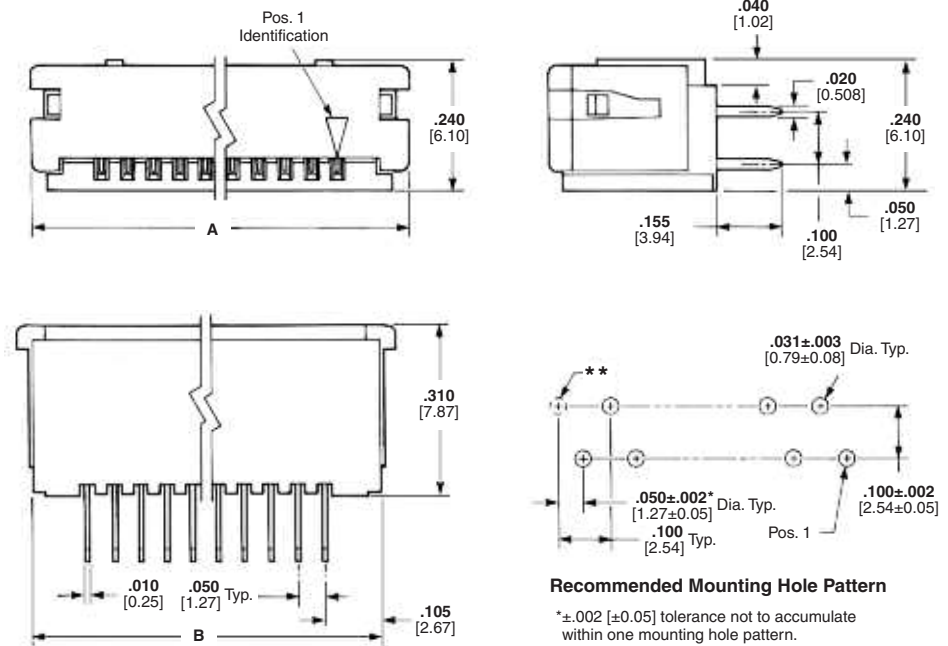

**Note:** ZIF-Line connector illustrated above with cover in closed position.

### Recommended Mounting Hole Pattern

\*±.002 [±0.05] tolerance not to accumulate within one mounting hole pattern.  
 \*\*This mounting hole required for even-numbered connector sizes only.

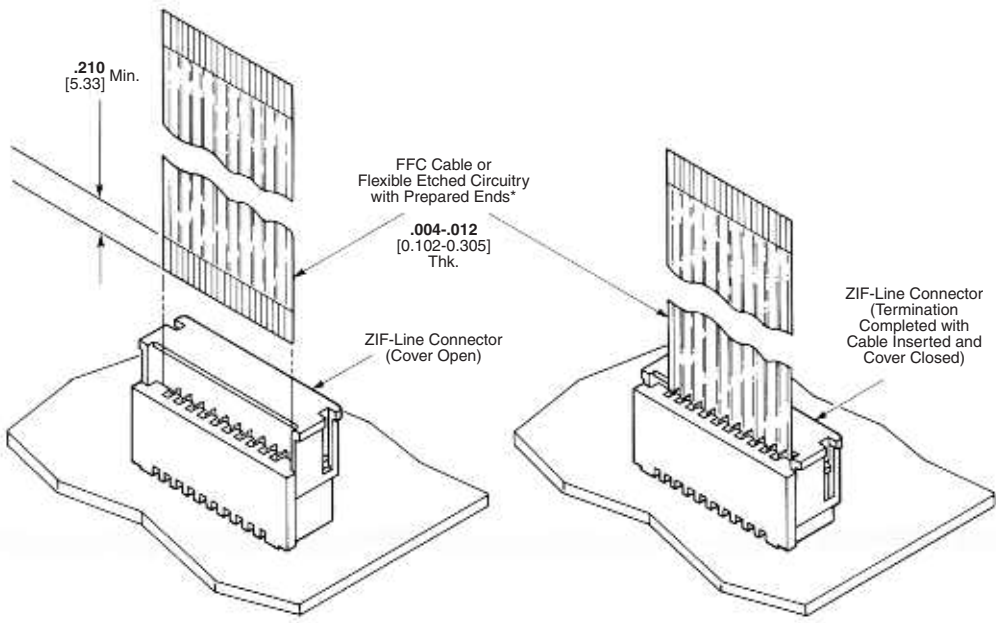

\*FFC cable with tin-plated prepared ends can be made available, consult TE.  
**Note:** Special preparation of cable is required, refer to TE Application Specification No. 114-16014.

Typical Flexible Flat Conductor Cable-to-Board Application

**ZIF-Line Connectors, .050 x .100 [1.27 x 2.54] Centerline,  
Cable-to-Board (Continued)**

No. of Pos.	Dimensions		Connector Part Numbers
	A	B	
5	.470 [11.94]	.410 [10.41]	5-487576-0
6	.520 [13.21]	.460 [11.68]	5-487576-1
7	.570 [14.48]	.510 [12.95]	4-487576-8
8	.620 [15.75]	.560 [14.22]	4-487576-9
9	.670 [17.02]	.610 [15.49]	487576-1
10	.720 [18.29]	.660 [16.76]	487576-2
11	.770 [19.56]	.710 [18.03]	487576-3
12	.820 [20.83]	.760 [19.30]	487576-4
13	.870 [22.10]	.810 [20.57]	487576-5
14	.920 [23.37]	.860 [21.84]	487576-6
15	.970 [24.64]	.910 [23.11]	487576-7
16	1.020 [25.91]	.960 [24.38]	487576-8
17	1.070 [27.18]	1.010 [25.65]	487576-9
18	1.120 [28.45]	1.060 [26.92]	1-487576-0
19	1.170 [29.72]	1.110 [28.19]	1-487576-1
20	1.220 [30.99]	1.160 [29.46]	1-487576-2
21	1.270 [32.26]	1.210 [30.73]	1-487576-3
22	1.320 [33.53]	1.260 [32.00]	1-487576-4
23	1.370 [34.80]	1.310 [33.27]	1-487576-5
24	1.420 [36.07]	1.360 [34.54]	1-487576-6
25	1.470 [37.34]	1.410 [35.81]	1-487576-7
26	1.520 [38.61]	1.460 [37.08]	1-487576-8
27	1.570 [39.88]	1.510 [38.35]	1-487576-9
28	1.620 [41.15]	1.560 [39.62]	2-487576-0
29	1.670 [42.42]	1.610 [40.89]	2-487576-1
30	1.720 [43.69]	1.660 [42.16]	2-487576-2

No. of Pos.	Dimensions		Connector Part Numbers
	A	B	
31	1.770 [44.96]	1.710 [43.43]	2-487576-3
32	1.820 [46.23]	1.760 [44.70]	2-487576-4
33	1.870 [47.50]	1.810 [45.97]	2-487576-5
34	1.920 [48.77]	1.860 [47.24]	2-487576-6
35	1.970 [50.04]	1.910 [48.51]	2-487576-7
36	2.020 [51.31]	1.960 [49.78]	2-487576-8
37	2.070 [52.58]	2.010 [51.05]	2-487576-9
38	2.120 [53.85]	2.060 [52.32]	3-487576-0
39	2.170 [55.12]	2.110 [53.59]	3-487576-1
40	2.220 [56.39]	2.160 [54.86]	3-487576-2
41	2.270 [57.66]	2.210 [56.13]	3-487576-3
42	2.320 [58.93]	2.260 [57.40]	3-487576-4
43	2.370 [60.20]	2.310 [58.67]	3-487576-5
44	2.420 [61.47]	2.360 [59.94]	3-487576-6
45	2.470 [62.74]	2.410 [61.21]	3-487576-7
46	2.520 [64.01]	2.460 [62.48]	3-487576-8
47	2.570 [65.28]	2.510 [63.75]	3-487576-9
48	2.620 [66.55]	2.560 [65.02]	4-487576-0
49	2.670 [67.82]	2.610 [66.29]	4-487576-1
50	2.720 [69.09]	2.660 [67.56]	4-487576-2
51	2.770 [70.36]	2.710 [68.83]	4-487576-3
52	2.820 [71.63]	2.760 [70.10]	4-487576-4
53	2.870 [72.90]	2.810 [71.37]	4-487576-5
54	2.920 [74.17]	2.860 [72.64]	4-487576-6
55	2.970 [75.44]	2.910 [73.91]	4-487576-7

**Note:** All part numbers are RoHS compliant.

## Cable-to-Board Connectors, .050 x .100 [1.27 x 2.54] Centerline, Ribbon Cable, System 50

### Product Facts

- Preassembled housing and cover
- One step termination
- End and daisy chain termination
- Positive end latching of connector to shrouded headers
- Terminates 30 AWG [0.05 mm<sup>2</sup>] solid or stranded and 32 AWG [0.03 mm<sup>2</sup>]\* stranded .025 [0.64] centerline ribbon cable with PVC insulation
- 0.5 ampere current rating (limited by cable)

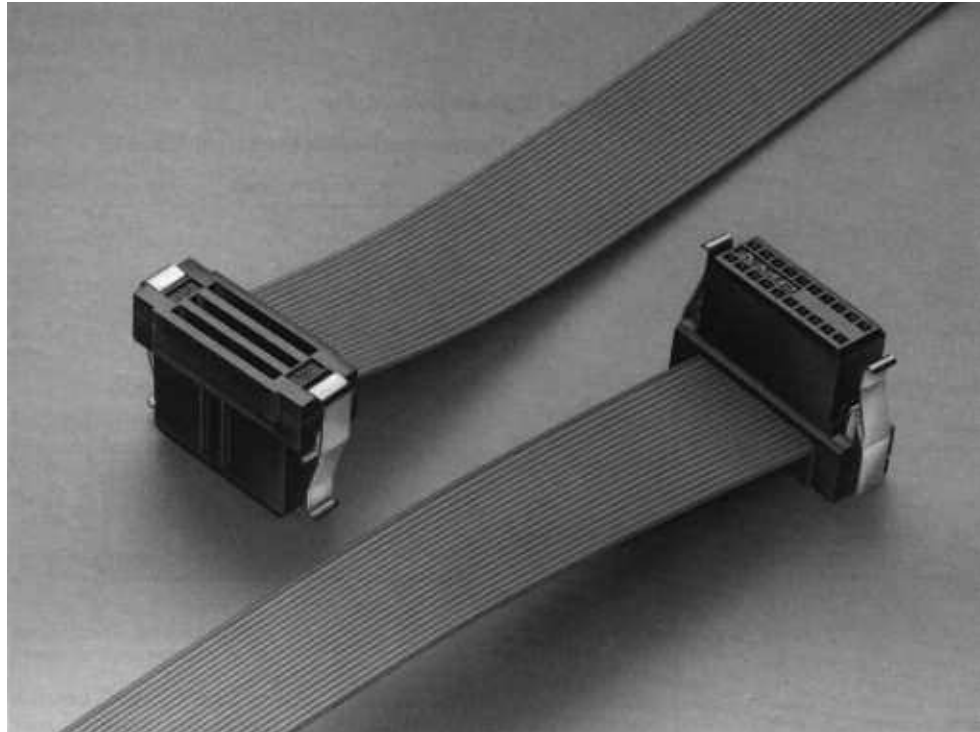

The AMP-LATCH System 50 Ribbon Cable connector is a receptacle connector that will terminate ribbon cable on .025 [0.64] centerlines. It is available in select sizes from 10 to 100 positions and will accommodate 30 AWG [0.05 mm<sup>2</sup>] solid or stranded and 32 AWG [0.03 mm<sup>2</sup>]

stranded conductors, with PVC cable insulation.

The housing and cover (black) have a 94V-0 rating. A copper alloy single mating beam contact provides the interconnect between the conductor and the .015 [0.38] square posts on the .050 x .100 [1.27 x 2.54] grid. The

contacts are plated with 30 gold duplex plating. The latching feature is located on the receptacle, not the header, and saves board space and eliminates future problems of "latch height compatibility."

## Double Row Receptacles, .050 x .100 [1.27 x 2.54] Centerline, Cable-to-Board, Ribbon Cable, System 50

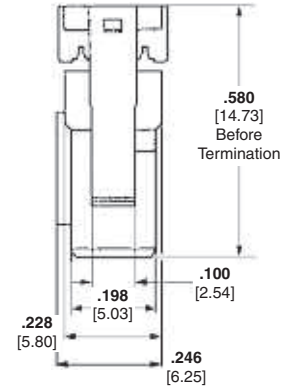
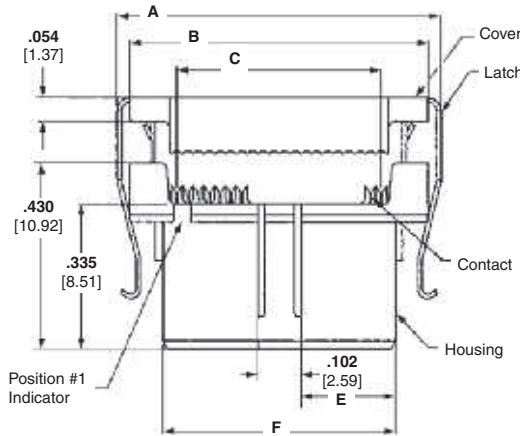
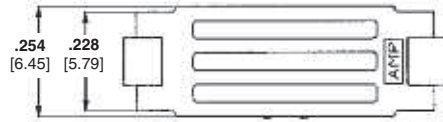

### Material and Finish

**Housing** — Black thermoplastic, 94V-0 rated

**Latches** — Stainless steel

**Contacts** — Copper alloy, plated gold over nickel with tin in termination area

### Related Product Data

**Performance Characteristics** — page 63

**Mateable Headers** — pages 29, 30, 34, 35 & 44

**Application Tooling** — page 60-62

**Mates with Posts** — .015 [0.38] square, .125 [3.18] long, on .050 x .100 [1.27 x 2.54] grid

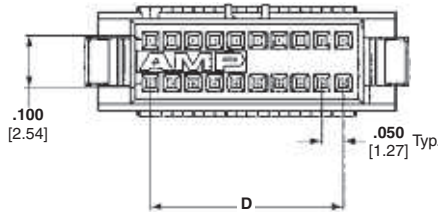

**Technical Documents** — page 64

**Product Specification** 108-1109

**Application Specification** 114-25029

No. of Pos.	Dimensions						Part Numbers
	A	B	C	D	E	F	
10	.510 [12.95]	.445 [11.30]	.225 [5.72]	.200 [5.08]	.096 [2.44]	.294 [7.47]	2-111196-5
14	.610 [15.49]	.545 [13.84]	.325 [8.26]	.300 [7.62]	.146 [3.71]	.394 [10.01]	2-111196-6
16	.660 [16.76]	.595 [15.11]	.375 [9.52]	.350 [8.89]	.171 [4.34]	.444 [11.28]	2-111196-7
20	.760 [19.30]	.695 [17.65]	.475 [12.07]	.450 [11.43]	.221 [5.61]	.544 [13.82]	1-111196-8
24	.860 [20.32]	.795 [20.19]	.575 [14.61]	.550 [13.97]	.271 [6.88]	.644 [16.36]	2-111196-8
26	.910 [23.11]	.845 [21.46]	.625 [15.88]	.600 [15.24]	.296 [7.52]	.694 [17.63]	2-111196-9
30	1.010 [25.65]	.945 [24.00]	.725 [18.42]	.700 [17.78]	.346 [8.79]	.794 [20.17]	1-111196-9
34	1.110 [28.19]	1.045 [26.54]	.825 [20.96]	.800 [20.32]	.396 [10.06]	.894 [22.71]	3-111196-0
40	1.260 [32.00]	1.195 [30.35]	.975 [24.81]	.950 [24.13]	.471 [11.96]	1.044 [26.52]	2-111196-0
44	1.360 [34.54]	1.295 [32.89]	1.075 [27.31]	1.050 [26.67]	.521 [13.23]	1.144 [29.06]	3-111196-1
50	1.510 [38.35]	1.445 [36.70]	1.225 [31.12]	1.200 [30.48]	.596 [15.14]	1.294 [32.87]	2-111196-1
60	1.760 [44.70]	1.695 [43.05]	1.475 [37.47]	1.450 [36.83]	.721 [18.31]	1.544 [39.22]	2-111196-2
64	1.860 [47.24]	1.795 [45.59]	1.575 [40.00]	1.550 [39.37]	.771 [19.58]	1.644 [41.76]	3-111196-2
68	1.960 [49.78]	1.895 [48.13]	1.675 [42.55]	1.650 [41.91]	.821 [20.85]	1.744 [44.30]	3-111196-4
72	2.060 [52.32]	1.995 [50.67]	1.775 [45.08]	1.750 [44.45]	.871 [22.12]	1.844 [46.84]	2-111196-3
80	2.260 [57.40]	2.195 [55.75]	1.975 [50.17]	1.950 [49.53]	.971 [24.66]	2.044 [51.92]	3-111196-3
100	2.760 [70.10]	2.695 [68.45]	2.475 [62.87]	2.450 [62.23]	1.221 [31.01]	2.544 [64.62]	2-111196-4

**Note:** All part numbers are RoHS compliant.



## Paddleboard Receptacles, .050 x .100 [1.27 x 2.54] Centerline, Cable-to-Board, Ribbon Cable, System 50

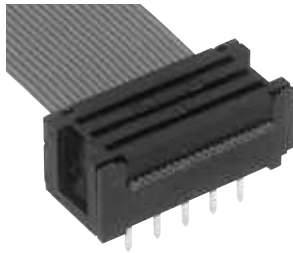

### Material and Finish

**Housing** — Black LCP thermoplastic, 94V-0 rated

**Cover** — Black polyester, 94V-0 rated

**Contacts** — Copper alloy, plated  
 .000100-.000200 [0.00245-0.00508]  
 bright tin over .000050-.000100  
 [0.00127-0.00254] nickel

### Related Product Data

**Performance Characteristics** —  
 page 63

**Application Tooling** — pages 60-62

**Technical Documents** — page 64

**Product Specification** 108-1109

**Application Specification**  
 114-25040

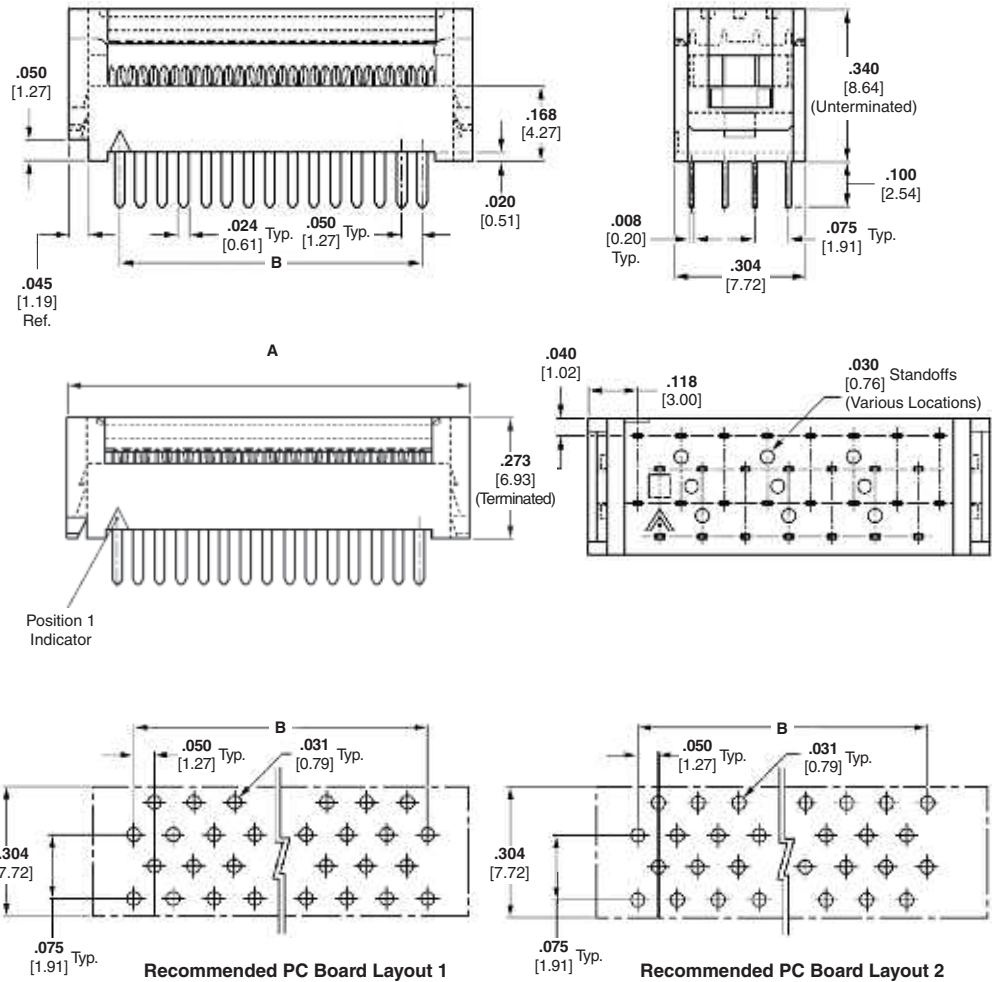

No. of Pos.	PCB Hole Layout	Dimensions		Part Numbers
		A	B	
10	1	.436 [11.07]	.200 [5.08]	5111595-1
14	1	.536 [13.61]	.300 [7.62]	5111595-2
16	2	.586 [14.88]	.350 [8.89]	5111595-3
20	2	.686 [17.42]	.450 [11.43]	5111595-4
24	2	.786 [19.96]	.550 [13.97]	5111595-5
26	1	.836 [21.23]	.600 [15.24]	5111595-6
28	2	.886 [22.50]	.650 [16.51]	2-5111595-0
30	1	.936 [23.77]	.700 [17.78]	5111595-7
34	1	1.036 [26.31]	.800 [20.32]	5111595-8
40	2	1.186 [30.12]	.950 [24.13]	5111595-9

No. of Pos.	PCB Hole Layout	Dimensions		Part Numbers
		A	B	
44	2	1.286 [32.66]	1.050 [26.67]	1-5111595-0
46	1	1.336 [33.93]	1.100 [27.94]	1-5111595-7
50	1	1.436 [36.47]	1.200 [30.48]	1-5111595-1
60	2	1.686 [42.82]	1.450 [36.83]	1-5111595-2
64	2	1.786 [45.36]	1.550 [39.37]	1-5111595-3
68	2	1.886 [47.90]	1.650 [41.91]	1-5111595-9
72	2	1.986 [50.44]	1.750 [44.45]	1-5111595-4
80	2	2.186 [55.52]	1.950 [49.53]	1-5111595-5
100	2	2.686 [68.22]	2.450 [62.23]	1-5111595-6

**Note:** All part numbers are RoHS compliant.

## Flat Ribbon Cable, PVC Insulation

**30 AWG [0.05 mm<sup>2</sup>],  
Solid Bare Copper**

**Product Specifications**

- Voltage** — 150 Volts
- Impedance** — 80 Ohms Nominal (GND, SIG, GND, applies to 30AWG Solid Bare Copper)
- Capacitance** — 19.2 pf/ft at 1 MHz nom.
- Propagation Delay** — 1.51 ns/ft nom.
- Crosstalk** —  
10 ft sample 5 ns rise time:  
Near End — 4.0% max.  
Far End — 6.0% max.
- UL Listing** — STYLE 2678

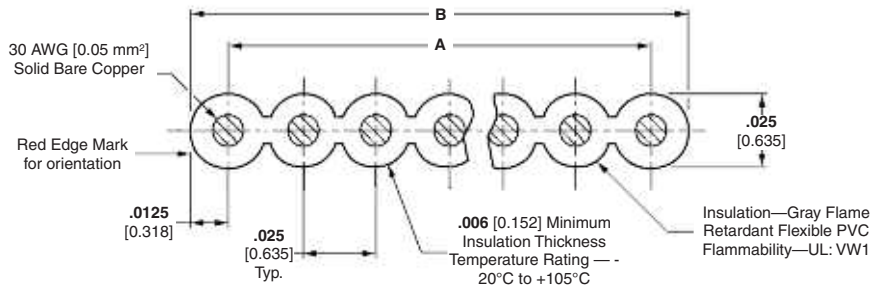

No. of Conductors	Dimensions		Part Numbers	
	A	B	Length Per Reel*	
			100 ft. [30.48 m]	500 ft. [152.4 m]
16	.375 [9.52]	.400 [10.16]	5-57013-1	5-57013-2
20	.475 [12.07]	.500 [12.70]	1-57013-3	57013-1
24	.575 [14.61]	.600 [15.24]	1-57013-4	57013-8
26	.625 [15.88]	.650 [16.51]	2-57013-5	2-57013-6
28	.675 [17.14]	.700 [17.78]	4-57013-6	4-57013-7
30	.725 [18.42]	.750 [19.05]	1-57013-5	57013-6
34	.825 [20.95]	.850 [21.59]	4-57013-9	5-57013-0
36	.875 [22.23]	.900 [22.86]	1-57013-6	57013-7
40	.975 [24.77]	1.000 [25.40]	1-57013-7	57013-2
44	1.075 [27.31]	1.100 [27.94]	1-57013-8	57013-9
50	1.225 [27.94]	1.250 [31.75]	1-57013-9	1-57013-0
60	1.475 [37.47]	1.500 [38.10]	2-57013-0	57013-3
68	1.675 [42.55]	1.700 [43.18]	2-57013-1	1-57013-1
72	1.775 [45.09]	1.800 [45.72]	2-57013-2	1-57013-2
80	1.975 [50.17]	2.000 [50.80]	2-57013-3	57013-4
100	2.475 [62.87]	2.500 [63.50]	2-57013-4	57013-5

\*Reel may contain separate lengths, 20 ft. [6.1 m] min. per length.

Recognized under the Component Program of Underwriters Laboratories Inc., File No. E53793



Certified by Canadian Standards Association, (CSA File No. LL83498)



## Electrical Characteristics of .025 [0.64] Centerline IDC Ribbon Cable

Base Part No.	Insulation	AWG	Voltage	Impedance Single Ended G-S-G	Capacitance Nominal G-S-G	Inductance Nominal	Nominal Prop. Delay	NEXT 10 Ft 5ns Rise Time	FEXT 10 Ft 5ns Rise Time
57013	PVC	30 Solid	150 Vac	80 Ohms Nom	19.2 pf/ft	.160 mh/ft	1.51 ns/ft	4.0% Max	6.0% Max
219054, 219137	TPE	30 Solid	150 Vac	90+/- 6 Ohms	15.3 pf/ft	.124 mh/ft	1.382 ns/ft	2.39% Nom	2.99% Nom
57119, 57139, 57145	FEP	30 Solid	300 Vac	93 Ohms Nom	13.6 pf/ft	.120 mn/ft	1.34 ns/ft	2.6% Nom	2.8% Nom
57131	PVC	30 Stranded	150 VAC	66 Ohms Nom	23.0 pf/ft	.100 mh/ft	1.55 ns/ft	2.8% Max	4.5% Max
219055	TPE	30 Stranded	150 VAC	78 Ohms Nom	19.4 pf/ft	.118 mh/ft	1.510 ns/fr	1.37% Nom	2.37% Nom
57288, 57289, 57290	FEP	30 Stranded	300 Vac	85 Ohms Nom	15.4 pf/ft	.110 mh/ft	1.36 ns/ft	2.5% Nom	2.8% Nom
219253	TPE	31 Stranded	150 Vac	90+/- 6 Ohms	15.4 pf/ft	.125 mh/ft	1.527 ns/ft	1.97% Nom	2.51% Nom
57038	PVC	32 Stranded	150 Vac	80 Ohms Nom	19.2 pf/ft	.147 mh/ft	1.51 ns/ft	4.0% Max	6.0% Max
219138	TPE	32 Stranded	150 Vac	104 Ohms Nom	12.8 pf/ft	.138 mh/ft	1.664 ns/ft	2.10% Nom	2.57% Nom
57118, 57138, 57144	FEP	32 Stranded	300 Vac	105 Ohms Nom	13.0 pf/ft	.120 mh/ft	1.36 ns/ft	2.6% Nom	2.8% Nom

**Note:** All part numbers are RoHS compliant.

## Centerline IDC Ribbon Cable, PVC Insulation

### 30 AWG 7/38 Stranded Tinned Copper

**For use with:**

AMP-LATCH System 50, AMPLIMITE .050 Series and AMPMODU System 50 Connectors

**Compatible with:**

AMP R-CAM Ribbon Cable Assembly Machine

**Product Specifications**

**Voltage Rating** — 150 Volts

**Impedance** — 66 ohms (GND, SIG, GND)

**Capacitance** — 23 pf/ft. at 1 KHz

**Propagation Delay** —

1.55 ns/ft. [5.6 ns/m]

**Crosstalk** —

10 Ft. sample 5 ns rise time

Near End — 2.8% max

Near End — 4.5% max

UL AWM Style 2678

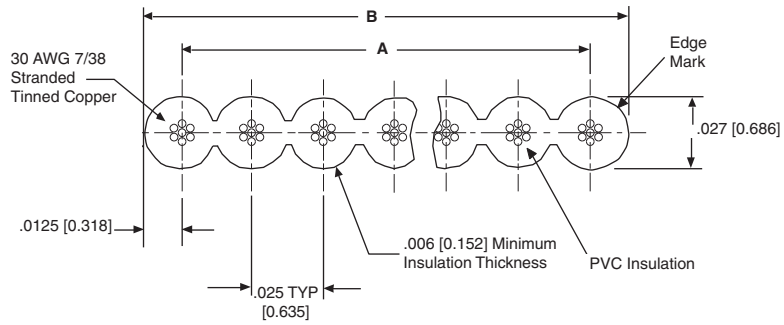

No. of Conductors	Dimensions		Part Numbers	
	A	B	Length Per Reel	
			100 ft. [30.5 m]	500 ft. [152.4 m]
20	.475 [12.07]	.500 [12.70]	1-57131-3	57131-1
40	.975 [24.77]	1.000 [25.40]	1-57131-7	57131-2
50	1.225 [31.12]	1.250 [31.75]	1-57131-9	1-57131-0
68	1.675 [42.55]	1.700 [43.18]	2-57131-1	1-57131-1
80	1.975 [50.17]	2.000 [50.80]	2-57131-3	57131-4
100	2.475 [62.87]	2.500 [63.50]	2-57131-4	57131-5

Flat Ribbon Cable

3

**Note:** All part numbers are RoHS compliant.

## Application Tooling for Flexible Film Contacts

### Hand Crimping Tool Assemblies (for repair purposes)



**Part No. 90273-5**—for .100  $\text{C}$  Multi-Crimp Contacts (408-9564)

### Extraction Tools for .100 $\text{C}$ Contacts

**Tool No. 91200-□\***— for Receptacle Housings with **Side Locking Lance Slot** (408-7916)

**Tool No. 91047-□\***— for Receptacle and Pin Housings with **End Locking Lance Slot** (408-7384)

\*Consult TE for specific dash nos.

For tooling information, contact the Technical Support Center: **1-800-522-6752**.

### Flexible Film Termination Machine (Terminates Continuous Strip Contacts Sequentially)

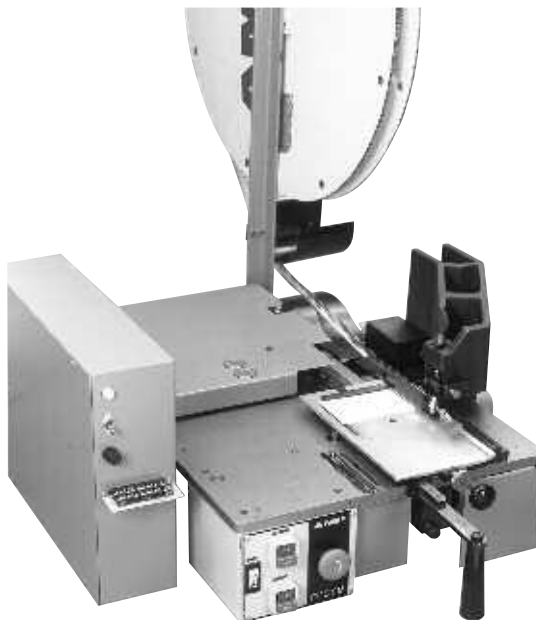

The flexible film semiautomatic bench machine for terminating .050 [1.27] and .100 [2.54] centerline flexible flat conductor cable (FFC), flexible etched circuitry (FEC), and flexible printed wiring (FPW) with AMP FFC reel-mounted contacts. For each cable or circuitry, the contacts are automatically applied one-at-a-time in a straight sequence. To skip positions, an optional programmer control box is available. Crimp height is easily adjustable in .0002 [.0051] increments. Termination rates up to 200 contacts per minute.

Description	Machine Part Numbers	
	Machine	Machine With Programmer*
.100 [2.54] $\text{C}$ , Multi-Crimp, 120 V	224910-1	318619-1
.100 [2.54] $\text{C}$ , Multi-Crimp, 240 V	224910-2	318619-2
.100 [2.54] $\text{C}$ , ARINC, 120 V	224910-3	318619-3
.050 [1.27] $\text{C}$ , Multi-Crimp, 120 V	224910-4	318619-4
.050 [1.27] $\text{C}$ , Multi-Crimp, 240 V	224910-6	318619-6

\*The Programmer Kit (**Part No. 356484-1**) may be purchased with a new machine, or separately for adding onto an existing machine.

### Technical Documents

**Customer Manuals**  
 409-5835 (Part Numbers 224910 and 318619)  
 409-5880 Programmer Kit (Part Number 356484-1)

### Specifications

**Width** — 20.5 [520]  
**Depth** — 27.5 [700]  
**Height** — 18 [460] (with reel support)  
**Reel Size** — 24 [610] (max.)  
**Weight** — 100 lb. [45.4 kg]  
**Electrical Source** —  
 120 VAC, 50/60 Hz, 7.0 A;  
 240 VAC, 50/60 Hz, 3.5 A

**Note:** All part numbers are RoHS compliant.

## Application Tooling for Compliant Pin Connectors

### ASG Servo Electric Presses for Compliant Pin Connectors

TE offers the ASG line of servo electric presses for the application of compliant pin products. Systems are available in a wide range of pressing forces, board size capabilities and automation levels to meet almost any applications requirements. Each system utilizes a servo electric motor with PC control. Coupled with force and distance monitoring and control, the entire line provides 100% quality assurance in real-time with SPC data collection capabilities. Automatic set up and a graphical operator interface help provide intuitive operation to help reduce common and costly operator errors.

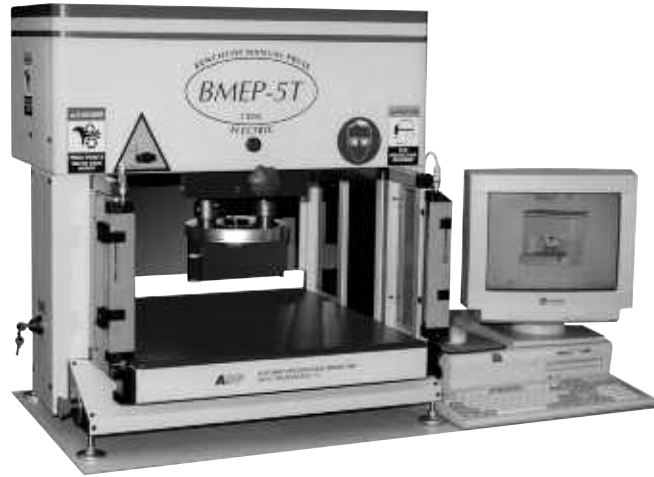

### Press Force Monitoring for Scrap Avoidance

Every TE ASG servo press utilizes real-time force and distance monitoring and control. This allows the press to identify an error and react throughout the press stroke. Common problems such as PCB holes above/below specification and sometimes bent pins can be detected by monitoring both minimum

and maximum force parameters. Common operator error such as improperly placed connectors, missing\incorrect connector or tooling can also be found by monitoring premature or missing force parameters. In each case, the system can stop during the press cycle to avoid costly scrap and rework.

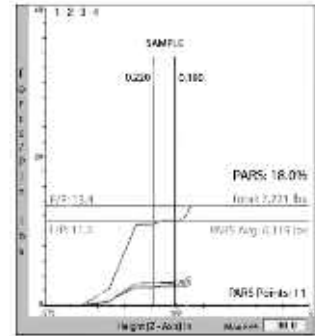

### Product Line Overview



	BMEP	MEP	AEP 6T	AEP 12T
System Type	Benchtop Semi-Automatic Press	Stand-Alone Semi-Automatic Press	Stand-Alone Automatic Press	Stand-Alone or Inline Automatic Press
Force Capability	Up to 5 Tons [44 kN]	Up to 12 Tons [107 kN]	Up to 6 Tons [53 kN]	Up to 12 Tons [107 kN]
Board Size Capability	Up to 18" x 24" [460x610 mm]	Up to 30" x 36" [760x915 mm]	Up to 30" x 36" [760x915 mm]	Up to 36" x 48" [915x1220 mm]

Please contact the Tyco Tooling Assistance Center at 1-800-722-1111 for help with choosing the correct press and tooling to meet your application needs. See Catalog 1309329 for more information on this equipment.

**Note:** All part numbers are RoHS compliant.

## Application Tooling for Ribbon Cable Connectors

These application tools are designed for one-step termination of ribbon cable connectors to planar, ground plane and shielded/jacketed ribbon cable on .025 [0.64] centers. A complete set of tooling consists of an Arbor Tool (manual, Part No. 91085-2 or pneumatic, Part No. 91112-3), a Base Assembly, Part No. 768338-4 and a Connector Specific Kit, Part No. 679167-1 (receptacle).



**Pneumatic Auto-Cycle Tool Part No. 91112-3**



**Manual Arbor Tool Part No. 91085-2**

### Technical Documents

#### Instruction Sheets

408-7777 — Manual Arbor Frame Assembly

408-6732 — Pneumatic Auto-Cycle Assembly

408-9827 — Universal Base Assembly, Arbor Tool

408-9872 — Connector Specific Kit for Receptacle Connectors (.025 [0.64] Centerline Cable)

408-9928 — Connector Specific Kit for Paddleboard Connectors (.025 [0.64] Centerline Cable)

**Note:** Tooling is available for other manufacturers' manual arbor tools. For information contact the TE Technical Support Center: 1-800-522-6752

**Note:** All part numbers are RoHS compliant.

## Performance Specifications

### Board-to-Board Spacing for Thru-Hole and Surface-Mount Connector Combinations

#### Thru-Hole Receptacle-Thru-Hole Header

(Single and Double Row, Shrouded and Unshrouded)

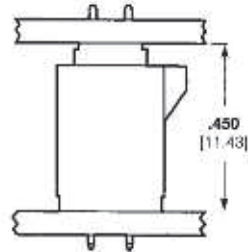

#### Thru-Hole Receptacle-Surface-Mount Header

(Double Row, Shrouded)

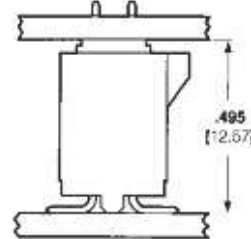

#### Surface-Mount Receptacle-Thru-Hole Header

(Double Row, Shrouded and Unshrouded)

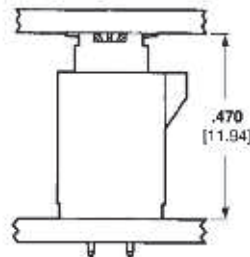

#### Surface-Mount Receptacle-Surface-Mount Header

(Double Row, Shrouded)

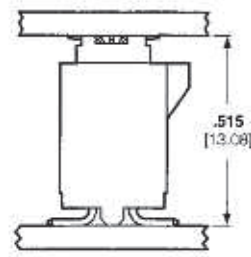

#### Need more information?

Call the Technical Support Center: **1-800-522-6752**.  
The Technical Support Center is staffed with specialists well versed in all TE products. The Center can provide you with:

- Technical Support
- Catalogs
- Technical Documents
- Product Samples
- TE Authorized Distributor Locations

### Performance Specifications

Description	Board-to-Board, Thru-Hole Headers and Receptacles	Board-to-Board, Surface-Mount, Headers and Receptacles	Cable-to-Board, .050 [1.27] Centerline FFC Cable Receptacles	Cable-to-Board, .025 [0.64] Centerline Ribbon Cable Receptacles
Size Range-Single Row Double Row	4 thru 50 10 thru 100	— 10 thru 100	4 thru 50 8 thru 100	— 10 thru 100
Current Rating (per contact)	1.0 amperes	1.0 amperes	1.5 amperes	0.5 amperes
Dielectric Withstanding Voltage	500 VAC	500 VAC	300 VAC	200 VAC
Insulation Resistance	5,000 Megohms	5,000 Megohms	5,000 Megohms	5,000 Megohms
Durability (tested to)	200 Cycles	200 Cycles	200 Cycles	150 Cycles
Mating Force (per contact)	5 oz. [1.38 N] Max.	5 oz. [1.38 N] Max.	8 oz. [2.22 N] Max.	4 oz. [1.11 N] Max.
Unmating Force (per contact)	0.8 oz. [0.22 N] Min.	0.8 oz. [0.22 N] Min.	1.0 oz. [0.27 N] Min.	*0.5 oz. [0.13 N] Min.
Operating Temperature	-65°C to +105°C	-65°C to +105°C	-55°C to +105°C	-65°C to +105°C

\*With latches depressed.

## Technical Documents

The following is a list of technical documents covering the application, performance and maintenance of AMPMODU System 50 connectors.

**Product Specifications** describe technical performance characteristics and verification tests. They are intended for the Design, Component and Quality Engineer.

- 108-1093—AMPMODU System 50 Interconnection System, Board-to-Board
- 108-1109—AMPLATCH System 50 Receptacle and Paddleboard Connector
- 108-16022—Connector System, .050 [1.27] Centerline FFC Cable
- 108-16025—Connector, ZIF-Line 50
- 108-16029—Shielded Flexible Flat Conductor Cable
- 108-40002—Flexible Flat Conductor Cable

**Application Specifications** describe requirements for using the product in its intended application and/or crimping information. They are intended for the Packaging and Design Engineer and the Machine Setup Person.

- 114-16008—Multiple Crimp Contact for .050 [1.27] Centerline FFC and FEC Cable
- 114-16014—AMP ZIF-Line 50 & 100 PCB Connectors
- 114-25029—AMPMODU System 50 Ribbon Cable Connectors
- 114-25031—AMPMODU System 50 Thru-Hole Connectors
- 114-25035—AMPMODU Surface-Mount Connectors
- 114-25040—AMPMODU System 50 Paddleboard Connectors

**Instruction Sheets** provide instructions for assembling or applying the product. They are intended for the Manufacturing Assembler or Operator.

- 408-6732—Pneumatic Arbor Tool, Part Number 91112-3 (Auto-Cycle)
- 408-7384—Extraction Tool, Part Number 91047
- 408-7763—Pneumatic Arbor Tool, Part Number 91112-2
- 408-7777—Manual Arbor Tool, Part Number 91085-2
- 408-7916—Extraction Tool, Part Number 91200
- 408-9827—Universal Base Assembly, Arbor Tool, Part Number 768338-1
- 408-9872—Connector Specific Kit, Part Number 679167-1, AMPMODU System 50 Receptacle Connectors (.025 [0.64] Centerline Cable)
- 408-9928—Connector Specific Kit, Part Number 679176-1, AMPMODU System 50 Paddleboard Connectors (.025 [0.64] Centerline Cable)
- 408-9564—Hand Crimping Tool Assembly, Part Number 90273-5
- 408-9719—FFC Contact Positioning Hand Tool Kit, Part Number 91292-1

**Note:** All part numbers are RoHS compliant.



## AMPMODU 2mm Connectors (Board to Board)

### Product Facts

- 2.0 x 2.0 [.08 x .08] centerline spacing
- Two-piece, double-row connector system
- Unshrouded header styles include; breakaway and surface-mount
- All headers with 0.5 [.02] square posted contacts
- Surface-mount connectors compatible with standard surface-mount processing (VPR, IR)
- Closed top-entry receptacle assemblies include; vertical mount and right-angle
- Receptacle contacts employ dual cantilever beams for two-point electrical stability
- Duplex (gold/tin-lead) plated posted contacts and receptacle contacts
- Thermoplastic housing material, UL 94V-0 rated
- Recognized under the Component Program of Underwriters Laboratories Inc., File No. E28476
- Certified by Canadian Standards Association, File No. LR7189
- Produced under a Quality Management System certified to ISO 9001



A copy of the certificate is available upon request.

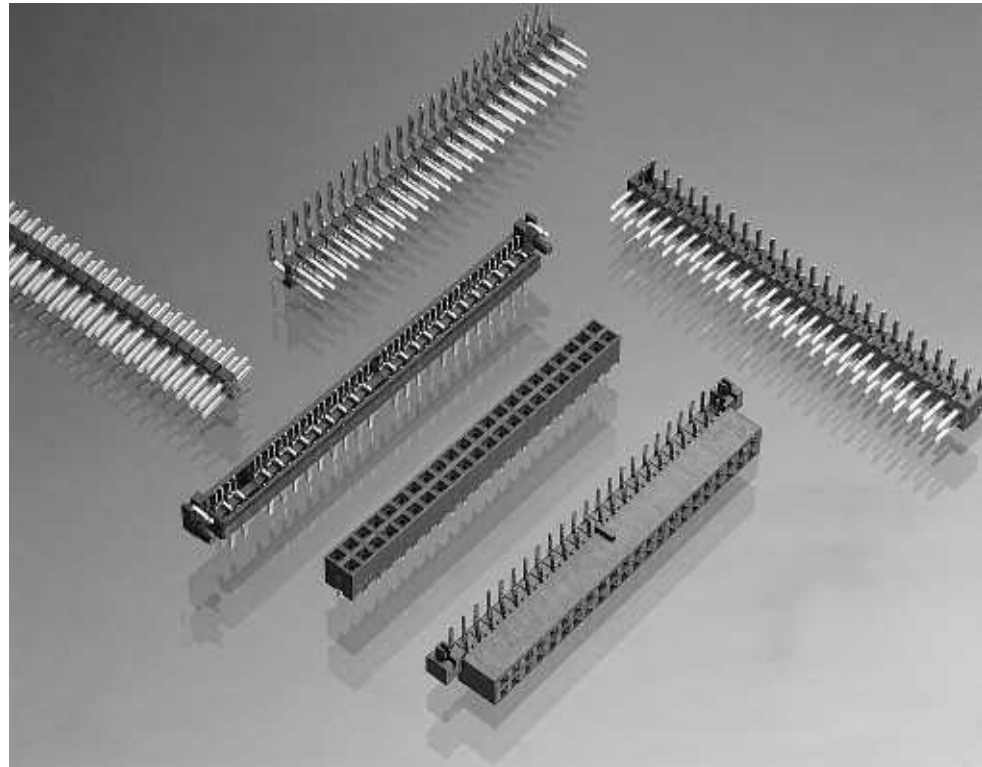

AMPMODU 2mm connectors reliably and economically meet the packaging and inter-connection requirements of today's miniature sophisticated electronics. They are ideal for mobile and portable personal computers and disk drive applications. In today's marketplace, 2mm is expanding over many other industry segments due to space constraints.

This versatile double-row connector system is comprised of various straight and right-angle posted headers for thru-hole and surface mounting and several closed top-entry receptacle assemblies for vertical and horizontal mounting. Headers and receptacle assemblies are available in selected sizes ranging from 4 through 80 positions.

Thru-hole breakaway headers feature brass straight or right-angle posts with a post length of 4.0 [.16] and a lead length of 2.6 [.10].

The receptacle assemblies employ phosphor bronze contacts with dual cantilever beams and built-in anti-overstress. This feature, coupled with duplex (gold/tin-lead) plating of the header posts and receptacle contacts, provide superior electrical performance as well as excellent solderability.

## 2mm Headers, Unshrouded, Double Row, Thru-Hole, Vertical Mount

### 0.5 [.02] Square Straight Posts

#### Material and Finish

**Housing** — Black thermoplastic, UL 94V-0 Rated

**Posted Contacts** — Copper alloy, duplex plated as follows:  
0.00020 [.000008] min. gold on contact area, 0.00254 [.000100] min. tin on solder area, with entire contact underplated 0.00127 [.000050] min. nickel

#### Related Product Data

**Mateable Receptacles** — pages 80-84

**Product Specification**  
108-57197

**Packaging Method** — Loose piece, bag

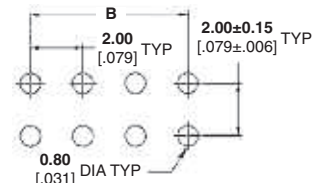
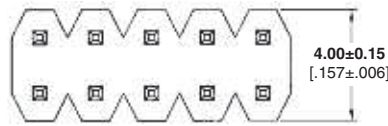

Recommended Solder Pad Layout

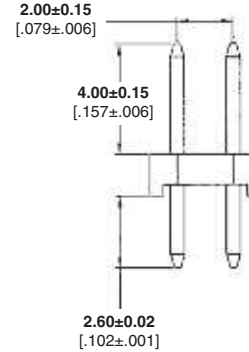
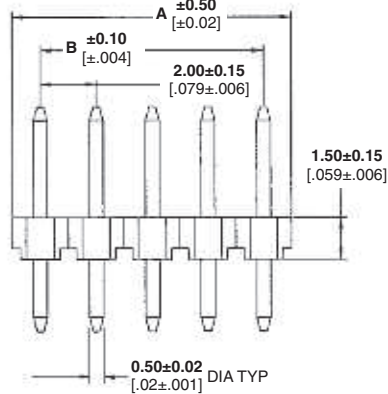

Position	Dimensions		Part Numbers	
	A	B	Reflow	
			240°C	265°C
4	4.0 [.16]	2.0 [.08]	1470213-4	1734508-4
6	6.0 [.24]	4.0 [.16]	1470213-6	1734508-6
8	8.0 [.32]	6.0 [.24]	1470213-8	1734508-8
10	10.0 [.39]	8.0 [.32]	1-1470213-0	1-1734508-0
12	12.0 [.47]	10.0 [.39]	1-1470213-2	1-1734508-2
14	14.0 [.55]	12.0 [.47]	1-1470213-4	1-1734508-4
16	16.0 [.63]	14.0 [.55]	1-1470213-6	1-1734508-6
18	18.0 [.71]	16.0 [.63]	1-1470213-8	1-1734508-8
20	20.0 [.79]	18.0 [.71]	2-1470213-0	2-1734508-0
22	22.0 [.87]	20.0 [.79]	2-1470213-2	2-1734508-2
24	24.0 [.94]	22.0 [.87]	2-1470213-4	2-1734508-4
26	26.0 [1.02]	24.0 [.94]	2-1470213-6	2-1734508-6
28	28.0 [1.10]	26.0 [1.02]	2-1470213-8	2-1734508-8
30	30.0 [1.18]	28.0 [1.10]	3-1470213-0	3-1734508-0
32	32.0 [1.26]	30.0 [1.18]	3-1470213-2	3-1734508-2
34	34.0 [1.34]	32.0 [1.26]	3-1470213-4	3-1734508-4
36	36.0 [1.42]	34.0 [1.34]	3-1470213-6	3-1734508-6
38	38.0 [1.50]	36.0 [1.42]	3-1470213-8	3-1734508-8
40	40.0 [1.57]	38.0 [1.50]	4-1470213-0	4-1734508-0
42	42.0 [1.65]	40.0 [1.57]	4-1470213-2	4-1734508-2
44	44.0 [1.73]	42.0 [1.65]	4-1470213-4	4-1734508-4
46	46.0 [1.81]	44.0 [1.73]	4-1470213-6	4-1734508-6
48	48.0 [1.89]	46.0 [1.81]	4-1470213-8	4-1734508-8
50	50.0 [1.97]	48.0 [1.89]	5-1470213-0	5-1734508-0
52	52.0 [2.05]	50.0 [1.97]	5-1470213-2	5-1734508-2
54	54.0 [2.13]	52.0 [2.05]	5-1470213-4	5-1734508-4
56	56.0 [2.20]	54.0 [2.13]	5-1470213-6	5-1734508-6
58	58.0 [2.28]	56.0 [2.20]	5-1470213-8	5-1734508-8
60	60.0 [2.36]	58.0 [2.28]	6-1470213-0	6-1734508-0
62	62.0 [2.44]	60.0 [2.36]	6-1470213-2	6-1734508-2
64	64.0 [2.52]	62.0 [2.44]	6-1470213-4	6-1734508-4
66	66.0 [2.60]	64.0 [2.52]	6-1470213-6	6-1734508-6
68	68.0 [2.68]	66.0 [2.60]	6-1470213-8	6-1734508-8
70	70.0 [2.76]	68.0 [2.68]	7-1470213-0	7-1734508-0
72	72.0 [2.83]	70.0 [2.76]	7-1470213-2	7-1734508-2
74	74.0 [2.91]	72.0 [2.83]	7-1470213-4	7-1734508-4
76	76.0 [2.99]	74.0 [2.91]	7-1470213-6	7-1734508-6
78	78.0 [3.07]	76.0 [2.99]	7-1470213-8	7-1734508-8
80	80.0 [3.15]	78.0 [3.07]	8-1470213-0	8-1734508-0

**Note:** All part numbers are RoHS compliant.

Breakaway Headers, Unshrouded, Double Row, Thru-Hole Mount

4

## 2mm Headers, Unshrouded, Double Row, Thru-Hole, Right-Angle Mount

### 0.5 [.02] Square Straight Posts

#### Material and Finish

**Housing** — Black thermoplastic, UL 94V-0 Rated, 265°C Process Capable

**Posted Contacts** — Copper alloy, duplex plated as follows:  
0.00020 [.000008] min. gold on contact area, 0.00254 [.000100] min. tin on solder area, with entire contact underplated 0.00127 [.000050] min. nickel

#### Related Product Data

**Mateable Receptacles** — pages 80-84

**Product Specification**  
108-57197

**Packaging Method** — Loose piece, bag

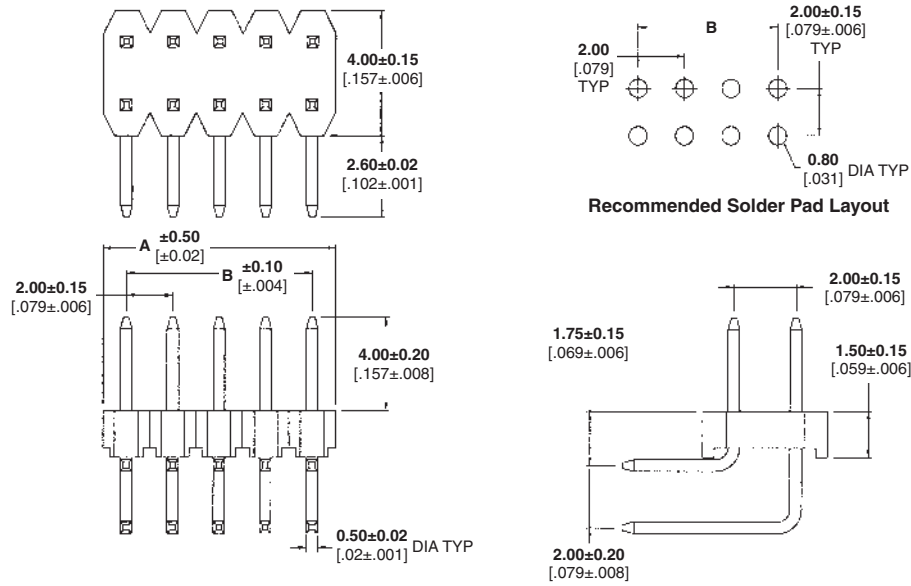

Position	Dimensions		Part Numbers
	A	B	
4	4.0 [0.16]	2.0 [0.08]	1734507-4
6	6.0 [0.24]	4.0 [0.16]	1734507-6
8	8.0 [0.31]	6.0 [0.24]	1734507-8
10	10.0 [0.39]	8.0 [0.31]	1-1734507-0
12	12.0 [0.47]	10.0 [0.39]	1-1734507-2
14	14.0 [0.55]	12.0 [0.47]	1-1734507-4
16	16.0 [0.63]	14.0 [0.55]	1-1734507-6
18	18.0 [0.71]	16.0 [0.63]	1-1734507-8
20	20.0 [0.79]	18.0 [0.71]	2-1734507-0
22	22.0 [0.87]	20.0 [0.79]	2-1734507-2
24	24.0 [0.94]	22.0 [0.87]	2-1734507-4
26	26.0 [1.02]	24.0 [0.94]	2-1734507-6
28	28.0 [1.10]	26.0 [1.02]	2-1734507-8
30	30.0 [1.18]	28.0 [1.10]	3-1734507-0
32	32.0 [1.26]	30.0 [1.18]	3-1734507-2
34	34.0 [1.34]	32.0 [1.26]	3-1734507-4
36	36.0 [1.42]	34.0 [1.34]	3-1734507-6
38	38.0 [1.50]	36.0 [1.42]	3-1734507-8
40	40.0 [1.57]	38.0 [1.50]	4-1734507-0
42	42.0 [1.65]	40.0 [1.57]	4-1734507-2
44	44.0 [1.73]	42.0 [1.65]	4-1734507-4
46	46.0 [1.81]	44.0 [1.73]	4-1734507-6
48	48.0 [1.89]	46.0 [1.81]	4-1734507-8
50	50.0 [1.97]	48.0 [1.89]	5-1734507-0
52	52.0 [2.05]	50.0 [1.97]	5-1734507-2
54	54.0 [2.13]	52.0 [2.05]	5-1734507-4
56	56.0 [2.20]	54.0 [2.13]	5-1734507-6
58	58.0 [2.28]	56.0 [2.20]	5-1734507-8
60	60.0 [2.36]	58.0 [2.28]	6-1734507-0
62	62.0 [2.44]	60.0 [2.36]	6-1734507-2
64	64.0 [2.52]	62.0 [2.44]	6-1734507-4
66	66.0 [2.60]	64.0 [2.52]	6-1734507-6
68	68.0 [2.68]	66.0 [2.60]	6-1734507-8
70	70.0 [2.76]	68.0 [2.68]	7-1734507-0
72	72.0 [2.83]	70.0 [2.76]	7-1734507-2
74	74.0 [2.91]	72.0 [2.83]	7-1734507-4
76	76.0 [2.99]	74.0 [2.91]	7-1734507-6
78	78.0 [3.07]	76.0 [2.99]	7-1734507-8
80	80.0 [3.15]	78.0 [3.07]	8-1734507-0

**Note:** All part numbers are RoHS compliant.

## 2mm Breakaway Headers, Unshrouded, Double Row, Thru-Hole, Right-Angle Mount

### 0.5 [.02] Square Right-Angle Posts

#### Material and Finish

**Housing** — Black thermoplastic, UL 94V-0 rated

**Posted Contacts** — Brass, duplex plated as follows:

**A** — 0.00020 [.000008] min. gold on contact area, 0.00100 [.000039] min. tin on solder area, with entire contact underplated 0.00130 [.000051] min. nickel

**B** — 0.00076 [.000030] min. gold on contact area, 0.00100 [.000039] min. tin on solder area, with entire contact underplated 0.00130 [.000051] min. nickel

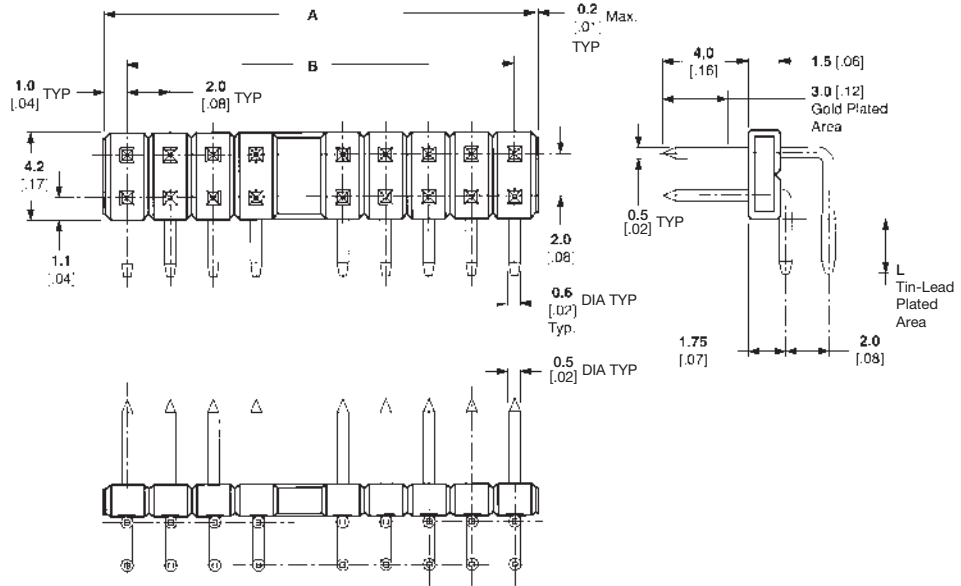

#### Related Product Data

**Mateable Receptacles** — pages 80-84

**Product Specification** 108-5296

**Packaging Method** — Loose piece, bag

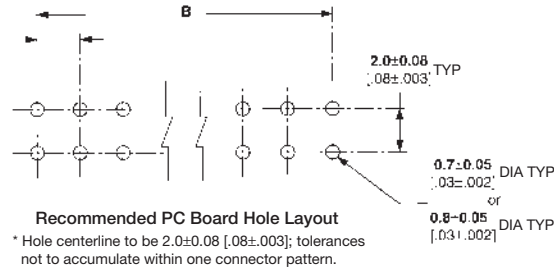

No. of Positions	Dimensions		Contact Plating Lead Length L = 2.6[.10]**	
	A	B	A	B
4	4.0 [0.16]	2.0 [0.08]	5176837-1	2-5176837-5
6	6.0 [0.24]	4.0 [0.16]	5176837-2	2-5176837-6
8	8.0 [0.31]	6.0 [0.24]	5176837-3	—
10	10.0 [0.39]	8.0 [0.31]	5176837-4	—
12	12.0 [0.47]	10.0 [0.39]	5176837-5	—
14	14.0 [0.55]	12.0 [0.47]	5176837-6	3-5176837-0
16	16.0 [0.63]	14.0 [0.55]	5176837-7	—
18	18.0 [0.71]	16.0 [0.63]	—	3-5176837-2
20	20.0 [0.79]	18.0 [0.71]	—	3-5176837-3
22	22.0 [0.87]	20.0 [0.79]	—	3-5176837-4
26	26.0 [1.02]	24.0 [0.94]	1-5176837-2	—
30	30.0 [1.18]	28.0 [1.10]	1-5176837-4	—
32	32.0 [1.26]	30.0 [1.18]	1-5176837-5	3-5176837-9
34	34.0 [1.34]	32.0 [1.26]	—	4-5176837-0
36	36.0 [1.42]	34.0 [1.34]	—	4-5176837-1
38	38.0 [1.50]	36.0 [1.42]	1-5176837-8	4-5176837-2
40	40.0 [1.57]	38.0 [1.50]	1-5176837-9	5-5176837-2
42	42.0 [1.65]	40.0 [1.57]	2-5176837-0	4-5176837-4
44	44.0 [1.73]	42.0 [1.65]	2-5176837-1	—
46	46.0 [1.81]	44.0 [1.73]	2-5176837-2	4-5176837-6
48	48.0 [1.89]	46.0 [1.81]	2-5176837-3	4-5176837-7
50	50.0 [1.97]	48.0 [1.89]	2-5176837-4	4-5176837-8

4 Breakaway Headers, Unshrouded, Double Row, Thru-Hole Mount

## 2mm Breakaway Headers, Unshrouded, Double Row, Thru-Hole, Vertical Mount

### 0.5 [.02] Square Straight Posts

#### Material and Finish

**Housing** — Black thermoplastic, UL 94V-0 rated

**Posted Contacts** — Brass, duplex plated as follows:

**Plating A** — 0.00020 [.000008] min. gold on contact area, 0.00100 [.000039] min. tin on solder area, with entire contact underplated 0.00130 [.000051] min. nickel

**Plating B** — 0.00076 [.000030] min. gold on contact area, 0.00100 [.000039] min. tin on solder area, with entire contact underplated 0.00130 [.000051] min. nickel

#### Related Product Data

**Mateable Receptacles** — pages 80-84

**Product Specification** 108-5296

**Packaging Method** — Loose piece, bag

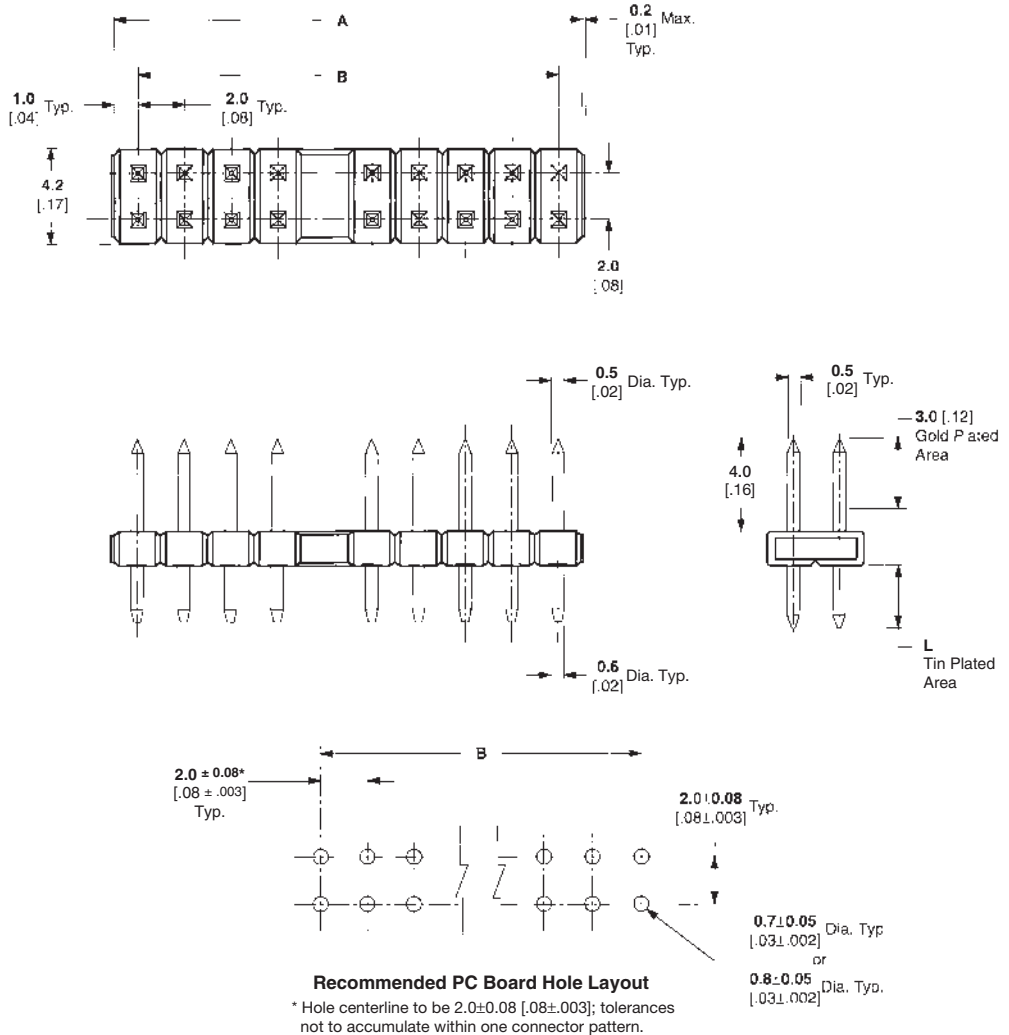

Breakaway Headers, Unshrouded, Double Row, Thru-Hole Mount

4

**2mm Breakaway Headers, Unshrouded, Double Row, Thru-Hole, Vertical Mount** (Continued)

**0.5 [.02] Square Straight Posts**

No. of Positions	Dimensions		Contact Plating			
			Lead Length L = 1.5 [.06]		Lead Length L = 2.6 [.10]	
	A	B	Plating A	Plating B	Plating A	Plating B
4	4.0 [0.16]	2.0 [0.08]	5178751-1	2-5178751-5	5176264-1	1-5176264-6
6	6.0 [0.24]	4.0 [0.16]	—	2-5178751-6	5176264-2	1-5176264-7
8	8.0 [0.31]	6.0 [0.24]	—	2-5178751-7	5176264-3	1-5176264-8
10	10.0 [0.39]	8.0 [0.31]	5178751-4	2-5178751-8	5176264-4	1-5176264-9
12	12.0 [0.47]	10.0 [0.39]	—	2-5178751-9	5176264-5	2-5176264-0
14	14.0 [0.55]	12.0 [0.47]	5178751-6	3-5178751-0	5176264-6	2-5176264-1
16	16.0 [0.63]	14.0 [0.55]	—	3-5178751-1	5176264-7	2-5176264-2
18	18.0 [0.71]	16.0 [0.63]	5178751-8	3-5178751-2	5176264-8	2-5176264-3
20	20.0 [0.79]	18.0 [0.71]	5178751-9	3-5178751-3	5176264-9	2-5176264-4
22	22.0 [0.87]	20.0 [0.79]	1-5178751-0	3-5178751-4	1-5176264-0	2-5176264-5
24	24.0 [0.94]	22.0 [0.87]	1-5178751-1	3-5178751-5	1-5176264-1	2-5176264-6
26	26.0 [1.02]	24.0 [0.94]	1-5178751-2	3-5178751-6	—	—
28	28.0 [1.10]	26.0 [1.02]	—	3-5178751-7	1-5176264-3	—
30	30.0 [1.18]	28.0 [1.10]	1-5178751-4	3-5178751-8	1-5176264-4	2-5176264-9
32	32.0 [1.26]	30.0 [1.18]	1-5178751-5	3-5178751-9	1-5176264-5	—
34	34.0 [1.34]	32.0 [1.26]	1-5178751-6	4-5178751-0	—	4-5176264-0
36	36.0 [1.42]	34.0 [1.34]	1-5178751-7	4-5178751-1	3-5176264-2	4-5176264-1
38	38.0 [1.50]	36.0 [1.42]	1-5178751-8	4-5178751-2	3-5176264-3	—
40	40.0 [1.57]	38.0 [1.50]	1-5178751-9	4-5178751-3	3-5176264-4	—
42	42.0 [1.65]	40.0 [1.57]	2-5178751-0	4-5178751-4	—	—
44	44.0 [1.73]	42.0 [1.65]	2-5178751-1	4-5178751-5	3-5176264-6	4-5176264-5
46	46.0 [1.81]	44.0 [1.73]	2-5178751-2	4-5178751-6	—	4-5176264-6
48	48.0 [1.89]	46.0 [1.81]	2-5178751-3	4-5178751-7	—	4-5176264-7
50	50.0 [1.97]	48.0 [1.89]	2-5178751-4	4-5178751-8	3-5176264-9	4-5176264-8

4 Breakaway Headers, Unshrouded, Double Row, Thru-Hole Mount

**Note:** All part numbers are RoHS compliant.

## 2mm Breakaway Headers, Unshrouded, Double Row, Surface Mount, Vertical Mount

### 0.5 [.02] Square Straight Posts

#### Material and Finish

**Housing** — Black polyphenylene sulfide, UL 94V-0 rated

**Posted Contacts** — Phosphor bronze, plated as follows, Duplex plated 0.00020 [.000008] min. gold on contact area, 0.00200 [.000079] min. tin on solder area, with entire contact underplated 0.00130 [.000051] min. nickel

#### Related Product Data

**Mateable Receptacles** — pages 80-84

**Product Specification** 108-51001

**Packaging Method** — Tape & Reel

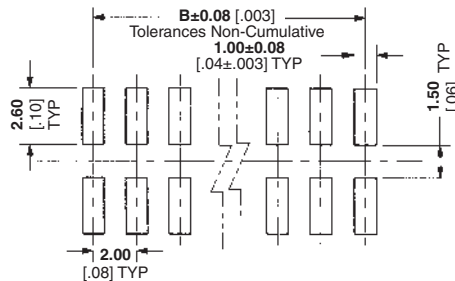
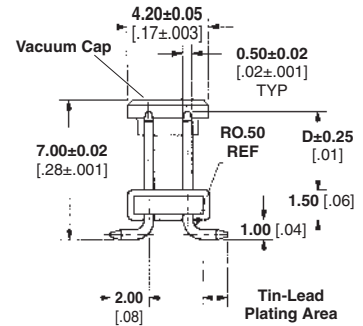
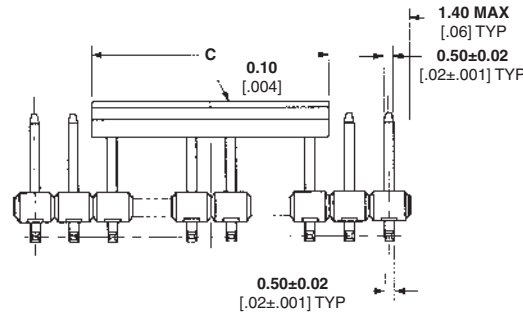
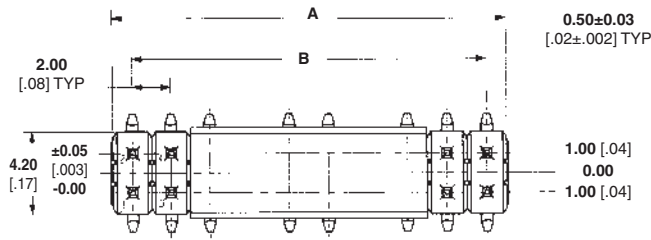

Recommended Solder Pad Layout

No. of Positions	Dimensions			Part Numbers
	A	B	C	
4	4.0 [0.16]	2.0 [0.08]	4.0 [0.16]	5084476-1
6	6.0 [0.24]	4.0 [0.16]	6.0 [0.24]	5084476-2
12	12.0 [0.47]	10.0 [0.39]	5.0 [0.20]	5084476-7
16	16.0 [0.63]	14.0 [0.55]	8.0 [0.31]	5084476-3

**Note:** All part numbers are RoHS compliant.

**2mm Breakaway Headers, Unshrouded, Double Row, Surface Mount, Vertical Mount** (Continued)

**0.5 [.02] Square Straight Posts**

**Material and Finish**

**Housing** — Black polyphenylene sulfide, UL 94V-0 rated

**Posted Contacts** — Phosphor bronze, plated as follows, Duplex plated 0.0076 [.000030] min. gold on contact area, 0.00254-0.00406 [.000100-.000160] min. tin on solder area, with entire contact underplated 0.00127 [.000050] min. nickel

**Related Product Data**

**Mateable Receptacles** — pages 80-84

**Product Specification** 108-18544

**Packaging Method** — Tape & Reel

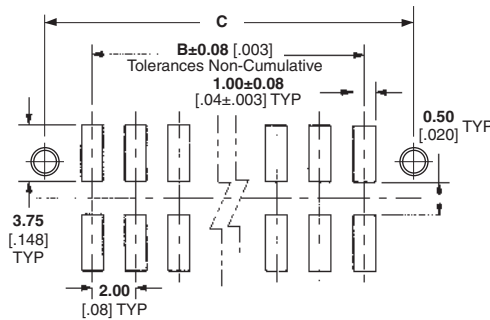
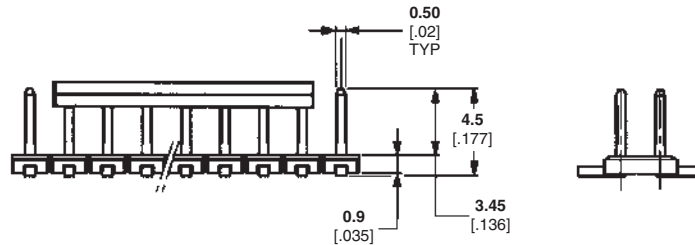
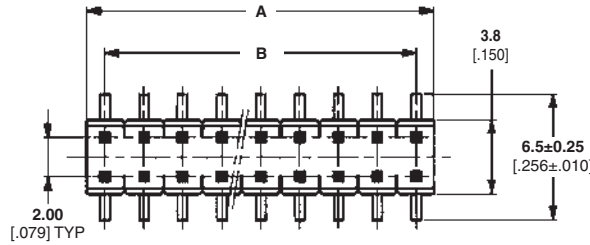

Recommended Solder Pad Layout

No. of Positions	Dimensions			Part Numbers
	A	B	C	
4	4.0 [0.16]	2.0 [0.08]	7.60 [0.30]	966926-2
6	6.0 [0.24]	4.0 [0.16]	9.60 [0.38]	966926-3
8	8.0 [0.31]	6.0 [0.24]	11.60 [0.46]	966926-4
10	10.0 [0.39]	8.0 [0.31]	13.60 [0.53]	966926-5
12	12.0 [0.47]	10.0 [0.39]	15.60 [0.61]	966926-6
14	14.0 [0.55]	12.0 [0.47]	17.60 [0.69]	966926-7
16	16.0 [0.63]	14.0 [0.55]	19.60 [0.77]	966926-8
18	18.0 [0.71]	16.0 [0.63]	21.60 [0.85]	966926-9
20	20.0 [0.79]	18.0 [0.71]	23.60 [0.93]	1-966926-0
22	22.0 [0.87]	20.0 [0.79]	25.60 [1.01]	1-966926-1
24	24.0 [0.94]	22.0 [0.87]	27.60 [1.09]	1-966926-2

**Note:** All part numbers are RoHS compliant.



## 2mm Stacking Header, Unshrouded, Double Row, Thru-Hole, Vertical Mount

**0.5 [.02] Square Straight Posts**

**12 Position**  
**Part Number 1734770-1**

**Material and Finish**

**Housing** — Black thermoplastic, UL 94 V-0 Rated

**Posted Contacts** — Copper alloy, duplex plated as follows:

Gold flash all over contact underplated 0.00127 [.000050] min. nickel

**Related Product Data**

**Mateable Receptacles** — pages 80-84

**Product Specification**  
108-57331

**Packaging Method** — Loose piece, bag

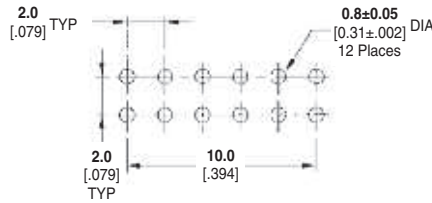
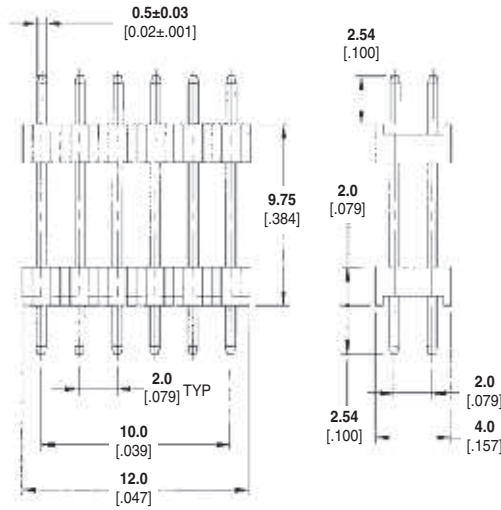

2.0 Pitch Vertical

4

**Note:** All part numbers are RoHS compliant.

**2mm Headers, Shrouded, Double Row, Thru-Hole, Right-Angle Mount**

**0.5 [.02] Square Right-Angle Posts**

**26 Position**  
**Part Number 5084780-1**

**Material and Finish**

**Housing** — High temperature, black thermoplastic, UL 94 V-O Rated

**Posted Contacts** — Copper alloy, duplex plated as follows: 0.00038 [.000015] min. gold on contact area, 0.00254 [.000100] min. tin on solder area, with entire contact underplated 0.00127 [.000050] min. nickel

**Related Product Data**

**Mateable Receptacles** — pages 80 and 84

**Product Specification**  
108-5296

**Packaging Method** — Tube

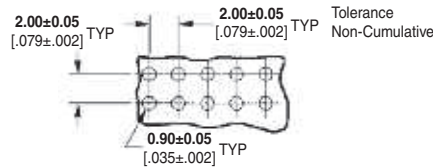
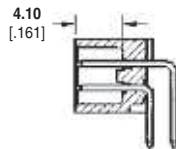
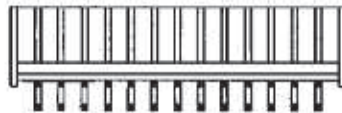
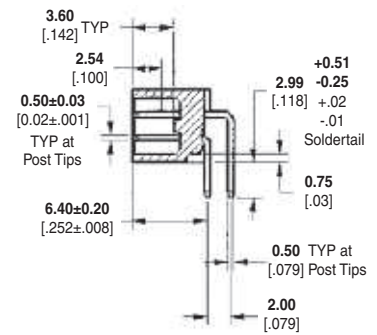
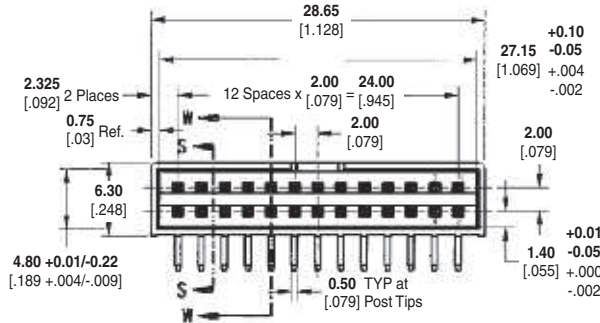
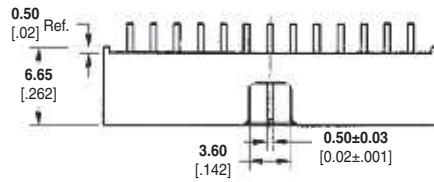

**Recommended PCB Layout**

**Note:** All part numbers are RoHS compliant.

2.0 Pitch Right-Angle

4

## 2mm Headers, Shrouded, Double Row, Thru-Hole, Right-Angle Mount

(Continued)

### 0.5 [0.02] Square Right-Angle Posts

#### Material and Finish

**Housing** — Natural color thermoplastic, UL 94 V-0 Rated

**Posted Contacts** — Brass, plated as follows:

0.00020 [0.00008] min. gold on contact area, with 0.00254 [0.00010] tin on soldertails, with entire contact underplated 0.00127 [0.00050] min. nickel

#### Related Product Data

**Mateable Receptacles** — pages 80 and 84

**Product Specification** 108-57197

**Packaging Method** — Tubes

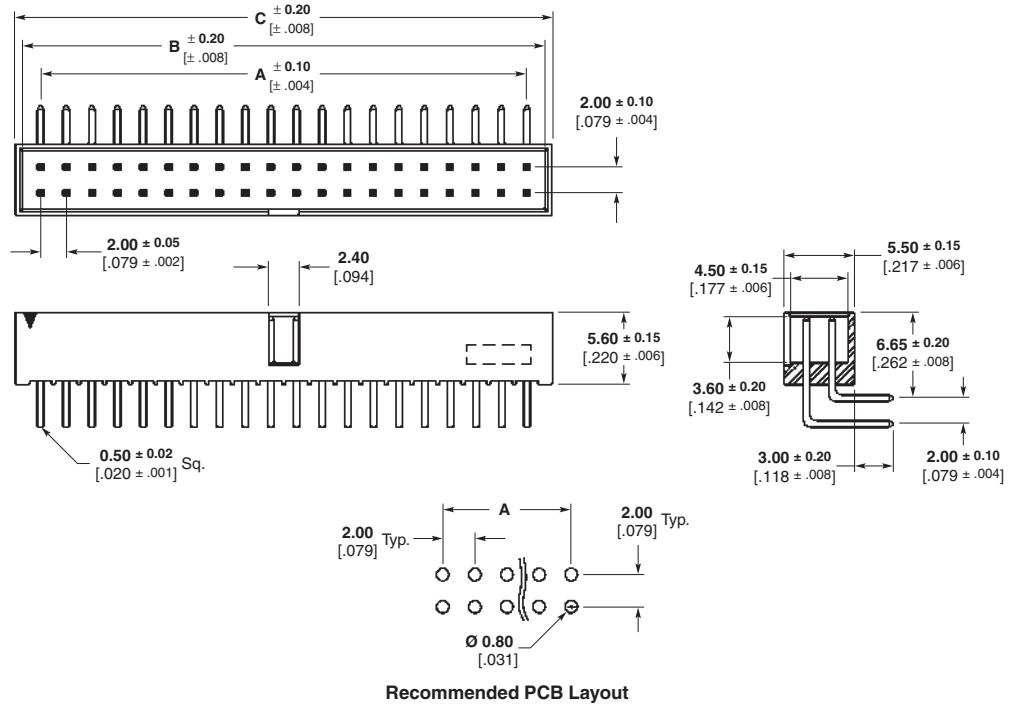

Recommended PCB Layout

No. of Positions	Dimensions			Part Numbers
	A	B	C	
8	6.0 [0.24]	8.85 [0.35]	9.95 [0.39]	1734493-8
10	8.0 [0.31]	10.85 [0.43]	11.95 [0.47]	1-1734493-0
12	10.0 [0.39]	12.85 [0.51]	13.95 [0.55]	1-1734493-2
14	12.0 [0.47]	14.85 [0.58]	15.95 [0.63]	1-1734493-4
16	14.0 [0.55]	16.85 [0.66]	17.95 [0.71]	1-1734493-6
18	16.0 [0.63]	18.85 [0.74]	19.95 [0.79]	1-1734493-8
20	18.0 [0.71]	20.85 [0.82]	21.95 [0.86]	2-1734493-0
22	20.0 [0.79]	22.85 [0.90]	23.95 [0.94]	2-1734493-2
24	22.0 [0.87]	24.85 [0.98]	25.95 [1.02]	2-1734493-4
26	24.0 [0.94]	26.85 [1.06]	27.95 [1.10]	2-1734493-6
28	26.0 [1.02]	28.85 [1.14]	29.95 [1.18]	2-1734493-8
30	28.0 [1.10]	30.85 [1.21]	31.95 [1.26]	3-1734493-0
32	30.0 [1.18]	32.85 [1.29]	33.95 [1.34]	3-1734493-2
34	32.0 [1.26]	34.85 [1.37]	35.95 [1.42]	3-1734493-4
36	34.0 [1.34]	36.85 [1.45]	37.95 [1.49]	3-1734493-6
38	36.0 [1.42]	38.85 [1.53]	39.95 [1.57]	3-1734493-8
40	38.0 [1.50]	40.85 [1.61]	41.95 [1.65]	4-1734493-0
42	40.0 [1.57]	42.85 [1.69]	43.95 [1.73]	4-1734493-2
44	42.0 [1.65]	44.85 [1.77]	45.95 [1.81]	4-1734493-4
46	44.0 [1.73]	46.85 [1.84]	47.95 [1.89]	4-1734493-6
48	46.0 [1.81]	48.85 [1.92]	49.95 [1.97]	4-1734493-8
50	48.0 [1.89]	50.85 [2.00]	51.95 [2.05]	5-1734493-0
52	50.0 [1.97]	52.85 [2.08]	53.95 [2.12]	5-1734493-2
54	52.0 [2.05]	54.85 [2.16]	55.95 [2.20]	5-1734493-4
56	54.0 [2.13]	56.85 [2.34]	57.95 [2.28]	5-1734493-6
58	56.0 [2.20]	58.85 [2.32]	59.95 [2.36]	5-1734493-8
60	58.0 [2.28]	60.85 [2.40]	61.95 [2.44]	6-1734493-0
62	60.0 [2.36]	62.85 [2.47]	63.95 [2.52]	6-1734493-2
64	62.0 [2.44]	64.85 [2.55]	65.95 [2.60]	6-1734493-4

**Note:** All part numbers are RoHS compliant.

## 2mm Headers, Shrouded, Double Row, Surface Mount, Vertical Mount

### 0.5 [.02] Square Posts

#### Material and Finish

**Housing** — Black color, PA9T (Nylon 9T), UL 94 V-0 Rated

**Posted Contacts** — Brass, plated as follows:

0.00076 [.000003] min. gold on contact area, with 0.00254 [.00010] matte tin on soldertails, with entire contact underplated 0.00127 [.000050] min. nickel

#### Related Product Data

**Mateable Receptacles** — pages 80, 81, and 84

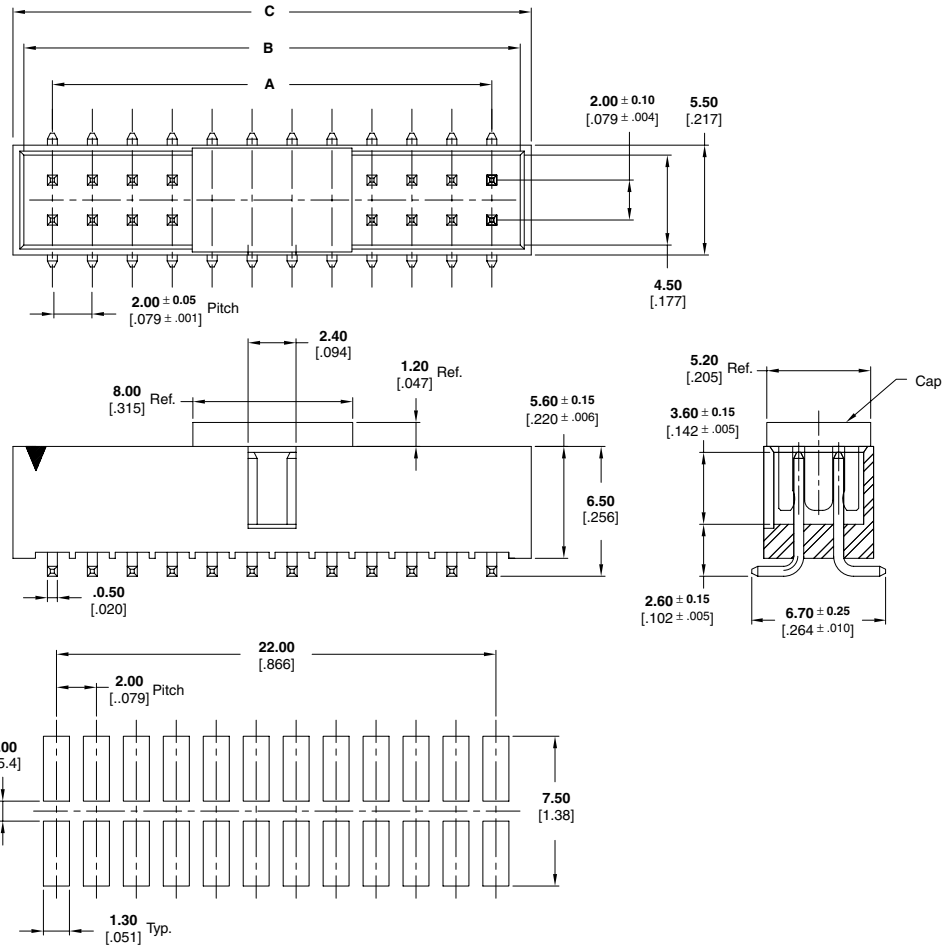

Recommended PCB Layout

No. of Positions	Dimensions			Part Numbers
	A	B	C	
8	6.0 [0.24]	8.85 [0.35]	9.95 [0.39]	2041068-8
10	8.0 [0.31]	10.85 [0.43]	11.95 [0.47]	1-2041068-0
12	10.0 [0.39]	12.85 [0.51]	13.95 [0.55]	1-2041068-2
14	12.0 [0.47]	14.85 [0.58]	15.95 [0.63]	1-2041068-4
16	14.0 [0.55]	16.85 [0.66]	17.95 [0.71]	1-2041068-6
18	16.0 [0.63]	18.85 [0.74]	19.95 [0.79]	1-2041068-8
20	18.0 [0.71]	20.85 [0.82]	21.95 [0.86]	2-2041068-0
22	20.0 [0.79]	22.85 [0.90]	23.95 [0.94]	2-2041068-2
24	22.0 [0.87]	24.85 [0.98]	25.95 [1.02]	2-2041068-4
26	24.0 [0.94]	26.85 [1.06]	27.95 [1.10]	2-2041068-6
28	26.0 [1.02]	28.85 [1.14]	29.95 [1.18]	2-2041068-8
30	28.0 [1.10]	30.85 [1.21]	31.95 [1.26]	3-2041068-0
32	30.0 [1.18]	32.85 [1.29]	33.95 [1.34]	3-2041068-2
34	32.0 [1.26]	34.85 [1.37]	35.95 [1.42]	3-2041068-4
36	34.0 [1.34]	36.85 [1.45]	37.95 [1.49]	3-2041068-6
38	36.0 [1.42]	38.85 [1.53]	39.95 [1.57]	3-2041068-8
40	38.0 [1.50]	40.85 [1.61]	41.95 [1.65]	4-2041068-0
42	40.0 [1.57]	42.85 [1.69]	43.95 [1.73]	4-2041068-2
44	42.0 [1.65]	44.85 [1.77]	45.95 [1.81]	4-2041068-4
46	44.0 [1.73]	46.85 [1.84]	47.95 [1.89]	4-2041068-6
48	46.0 [1.81]	48.85 [1.92]	49.95 [1.97]	4-2041068-8
50	48.0 [1.89]	50.85 [2.00]	51.95 [2.05]	5-2041068-0

**Note:** All part numbers are RoHS compliant.

2.0 Pitch Vertical

4

**2mm Headers, Shrouded, Double Row, Surface Mount, Vertical Mount**

(Continued)

**0.5 [.02] Square Straight Posts**

**Material and Finish**

**Housing** — Black high temperature thermoplastic, UL 94 V-O Rated

**Posted Contacts** — Phosphor Bronze, duplex plated as follows:

0.00076(0.000030) min. gold on contact area, 0.00381(.000150) min. tin on solder area, with entire contact underplated 0.00127(.000050) min. nickel

**Product Specification**

108-57328

**Packaging Method** — Tape and reel

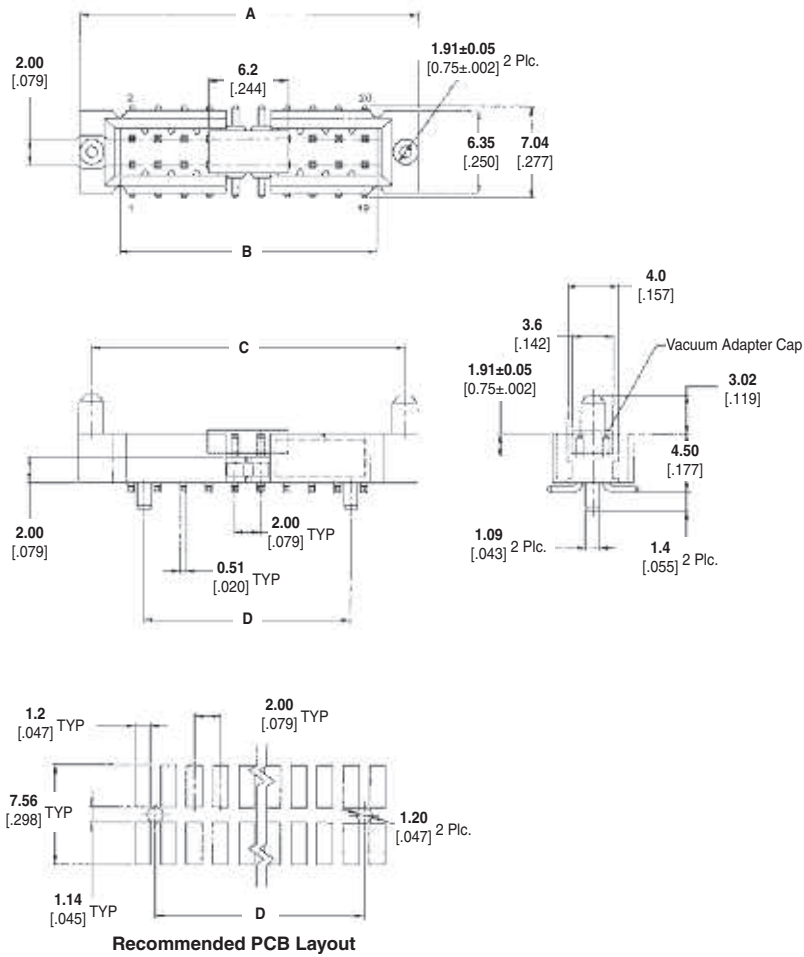

No. of Positions	Dimensions				Part Numbers
	A	B	C	D	
20	26.2 [1.03]	20.0 [0.79]	24.3 [0.96]	16.0 [.63]	2-1734569-0
30	36.2 [1.43]	30.0 [1.18]	34.3 [1.35]	26.0 [1.02]	3-1734569-0

**Note:** All part numbers are RoHS compliant.

## 2mm Headers, Shrouded, Double Row, Thru-Hole, Vertical Mount

### 0.5 [.02] Square Straight Posts with Cable Shroud

#### Material and Finish

**Housing** — Black thermoplastic, UL 94 V-0 Rated

**Posted Contacts** — Brass, duplex plated as follows:  
0.00254 [.000100] min. tin on contact area, with entire contact underplated  
0.00127 [.000050] min. nickel

#### Related Product Data

**Mateable Receptacles** —  
See Drawings 1470106 Contacts and 1470107 Housing

**Product Specification**  
108-57217

**Packaging Method** — Loose piece, bag

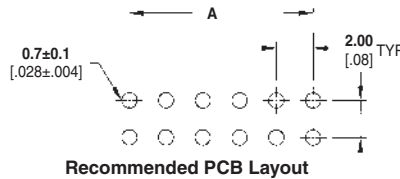
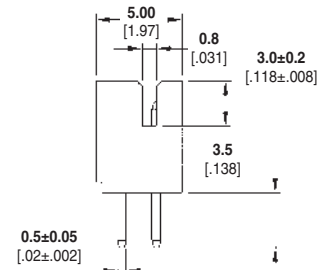
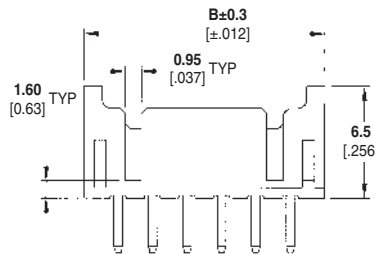
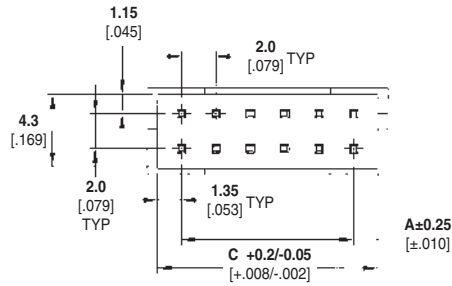

No. of Position	Dimensions			Part Numbers
	A	B	C	
6	4.0 [0.16]	8.0 [0.31]	6.74 [0.26]	1470109-6
8	6.0 [0.24]	10.0 [0.39]	8.74 [0.34]	1470109-8
10	8.0 [0.31]	12.0 [0.47]	10.74 [0.42]	1-1470109-0
12	10.0 [0.39]	14.0 [0.55]	12.74 [0.50]	1-1470109-2
14	12.0 [0.47]	16.0 [0.63]	14.74 [0.58]	1-1470109-4
16	14.0 [0.55]	18.0 [0.71]	16.74 [0.66]	1-1470109-6
18	16.0 [0.63]	20.0 [0.79]	18.74 [0.74]	1-1470109-8
20	18.0 [0.71]	22.0 [0.87]	20.74 [0.82]	2-1470109-0
22	20.0 [0.79]	24.0 [0.94]	22.74 [0.89]	2-1470109-2
24	22.0 [0.87]	26.0 [1.02]	24.74 [0.97]	2-1470109-4
26	24.0 [0.94]	28.0 [1.10]	26.74 [1.05]	2-1470109-6
28	26.0 [1.02]	30.0 [1.18]	28.74 [1.13]	2-1470109-8
30	28.0 [1.10]	32.0 [1.26]	30.74 [1.21]	3-1470109-0
32	30.0 [1.18]	34.0 [1.34]	32.74 [1.29]	3-1470109-2

**Note:** All part numbers are RoHS compliant.

## 2mm Headers, Shrouded, Double Row, Thru-Hole, Right-Angle Mount

### 0.5 [.02] Square Right-Angle Posts with Cable Shroud

#### Material and Finish

**Housing** — Black thermoplastic, UL 94 V-0 Rated

**Posted Contacts** — Brass, duplex plated as follows:

0.00254 [.000100] min. tin on contact area, with entire contact underplated  
0.00127 [.000050] min. nickel

#### Related Product Data

**Mateable Receptacles** — See Drawings 1470106 Contacts and 1470107 Housing

**Product Specification**  
108-57217

**Packaging Method** — Loose piece, bag

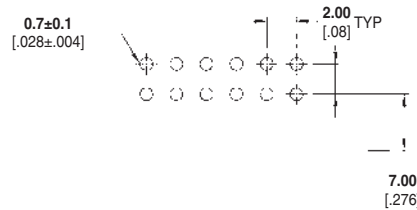
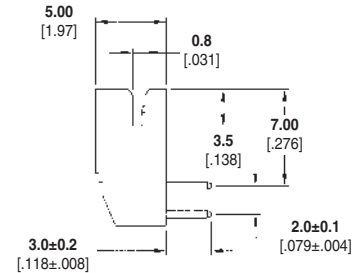
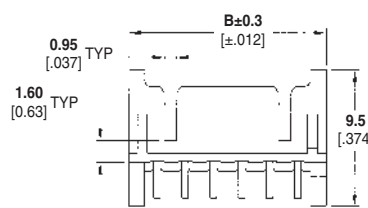
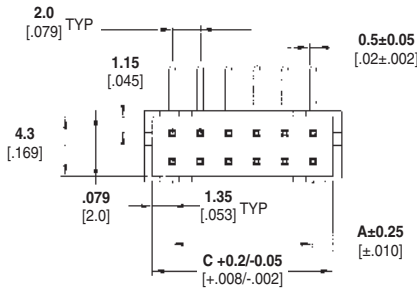

Recommended PCB Layout

No. of Position	Dimensions			Part Numbers
	A	B	C	
6	4.0 [0.16]	8.00 [0.31]	6.74 [0.26]	1470108-6
8	6.0 [0.24]	10.00 [0.39]	8.74 [0.34]	1470108-8
10	8.0 [0.32]	12.00 [0.47]	10.74 [0.42]	1-1470108-0
12	10.0 [0.39]	14.00 [0.55]	12.74 [0.50]	1-1470108-2
14	12.0 [0.47]	16.00 [0.63]	14.74 [0.58]	1-1470108-4
16	18.0 [0.71]	18.00 [0.71]	16.74 [0.66]	1-1470108-6
18	14.0 [0.55]	20.00 [0.79]	18.74 [0.74]	1-1470108-8
20	16.0 [0.63]	22.00 [0.87]	20.74 [0.82]	2-1470108-0
22	22.0 [0.87]	24.00 [0.94]	22.74 [0.89]	2-1470108-2
24	20.0 [0.79]	26.00 [1.02]	24.74 [0.97]	2-1470108-4
26	24.0 [0.94]	28.00 [1.10]	26.74 [1.05]	2-1470108-6
28	28.0 [1.10]	30.00 [1.18]	28.74 [1.13]	2-1470108-8
30	26.0 [1.02]	32.00 [1.26]	30.74 [1.21]	3-1470108-0
32	30.0 [1.18]	34.00 [1.34]	32.74 [1.29]	3-1470108-2

**Note:** All part numbers are RoHS compliant.

## 2mm Centerline Receptacles, Double Row, Thru-Hole, Vertical Mount

### Receptacle, Thru-Hole, Vertical

#### Material and Finish

**Housing** — Black thermoplastic, UL 94 V-0 Rated, 245°C Reflow

**Contacts** — Copper alloy, plated as follows:

**A** — 0.00020 [.000008] min. gold on contact area, 0.00203 [.000080] min. tin on solder area, with entire contact underplated 0.00127 [.000050] min. nickel

**B** — 0.00076 [.000030] min. gold on contact area, 0.00203 [.000080] min. tin on solder area, with entire contact underplated 0.00127 [.000050] min. nickel

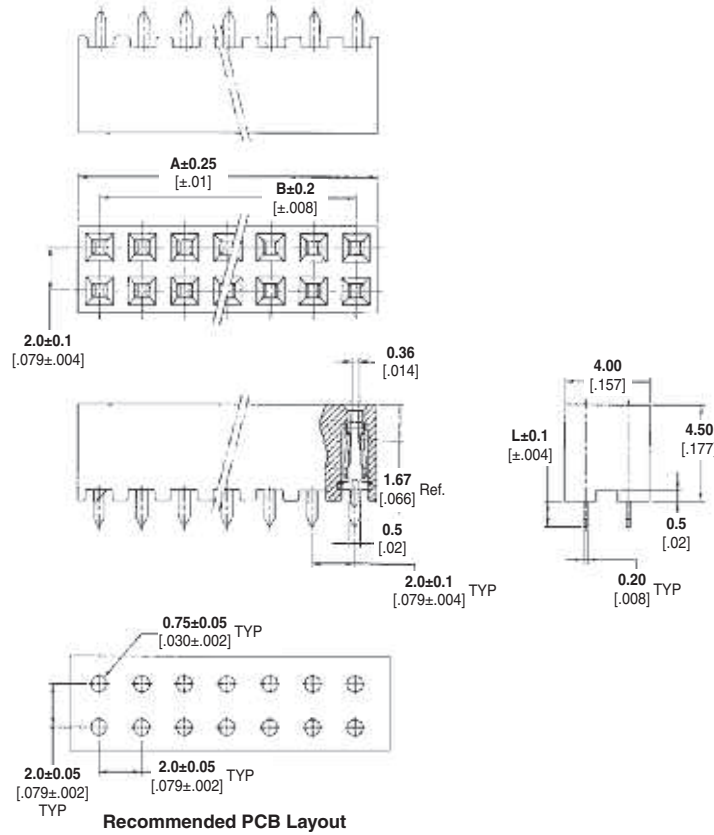

#### Related Product Data

**Mateable Headers** — pages 66-76, 78, 79

**Product Specification** 108-57197

**Packaging Method** — Tray

2.0 Mount Type w/PickUp

4

No. of Positions	Dimensions		Part Numbers			
			Plating A		Plating B	
			Dim. L 1.2+/-0.1 (.047+/-0.004)	Dim. L 2.6+/-0.1 (.102+/-0.004)	Dim. L 1.2+/-0.1 (.047+/-0.004)	Dim. L 2.6+/-0.1 (.102+/-0.004)
4	4.0 [0.157]	2.0 [0.079]	1470209-1	2-1470209-5	5-1470209-1	7-1470209-5
6	6.0 [0.236]	4.0 [0.157]	1470209-2	2-1470209-6	5-1470209-2	7-1470209-6
8	8.0 [0.315]	6.0 [0.236]	1470209-3	2-1470209-7	5-1470209-3	7-1470209-7
10	10.0 [0.394]	8.0 [0.315]	1470209-4	2-1470209-8	5-1470209-4	7-1470209-8
12	12.0 [0.472]	10.0 [0.394]	1470209-5	2-1470209-9	5-1470209-5	7-1470209-9
14	14.0 [0.551]	12.0 [0.472]	1470209-6	3-1470209-0	5-1470209-6	8-1470209-0
16	16.0 [0.630]	14.0 [0.551]	1470209-7	3-1470209-1	5-1470209-7	8-1470209-1
18	18.0 [0.709]	16.0 [0.630]	1470209-8	3-1470209-2	5-1470209-8	8-1470209-2
20	20.0 [0.787]	18.0 [0.709]	1470209-9	3-1470209-3	5-1470209-9	8-1470209-3
22	22.0 [0.866]	20.0 [0.787]	1-1470209-0	3-1470209-4	6-1470209-0	8-1470209-4
24	24.0 [0.945]	22.0 [0.866]	1-1470209-1	3-1470209-5	6-1470209-1	8-1470209-5
26	26.0 [1.024]	24.0 [0.945]	1-1470209-2	3-1470209-6	6-1470209-2	8-1470209-6
28	28.0 [1.102]	26.0 [1.024]	1-1470209-3	3-1470209-7	6-1470209-3	8-1470209-7
30	30.0 [1.181]	28.0 [1.102]	1-1470209-4	3-1470209-8	6-1470209-4	8-1470209-8
32	32.0 [1.260]	30.0 [1.181]	1-1470209-5	3-1470209-9	6-1470209-5	8-1470209-9
34	34.0 [1.339]	32.0 [1.260]	1-1470209-6	4-1470209-0	6-1470209-6	9-1470209-0
36	36.0 [1.417]	34.0 [1.339]	1-1470209-7	4-1470209-1	6-1470209-7	9-1470209-1
38	38.0 [1.496]	36.0 [1.417]	1-1470209-8	4-1470209-2	6-1470209-8	9-1470209-2
40	40.0 [1.575]	38.0 [1.496]	1-1470209-9	4-1470209-3	6-1470209-9	9-1470209-3
42	42.0 [1.654]	40.0 [1.575]	2-1470209-0	4-1470209-4	7-1470209-0	9-1470209-4
44	44.0 [1.732]	42.0 [1.654]	2-1470209-1	4-1470209-5	7-1470209-1	9-1470209-5
46	46.0 [1.811]	44.0 [1.732]	2-1470209-2	4-1470209-6	7-1470209-2	9-1470209-6
48	48.0 [1.890]	46.0 [1.811]	2-1470209-3	4-1470209-7	7-1470209-3	9-1470209-7
50	50.0 [1.969]	48.0 [1.890]	2-1470209-4	4-1470209-8	7-1470209-4	9-1470209-8

**Note:** All part numbers are RoHS compliant.



**2mm Centerline Receptacles, Double Row, Thru-Hole, Vertical Mount (Continued)**

**Receptacle, Thru-Hole, Vertical**

**Material and Finish**

**Housing** — Black thermoplastic, UL 94 V-O Rated, 265°C Process Capable

**Contacts** — Copper alloy, plated as follows:

**A** — 0.00020 [.000008] min. gold on contact area, 0.00203 [.000080] min. tin on solder area, with entire contact underplated 0.00127 [.000050] min. nickel

**B** — 0.00076 [.000030] min. gold on contact area, 0.00203 [.000080] min. tin on solder area, with entire contact underplated 0.00127 [.000050] min. nickel

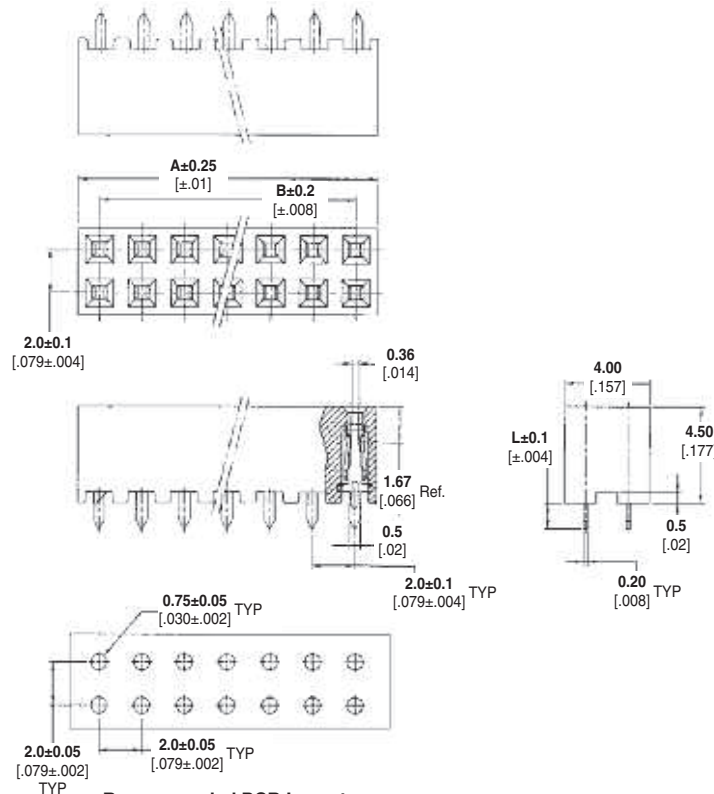

**Related Product Data**

**Mateable Headers** — pages 66-76, 78, 79

**Product Specification** 108-57197

**Packaging Method** — Tray

No. of Positions	Dimensions		Part Numbers			
			Plating A		Plating B	
			Dim. L 1.2+/-0.1 (.047+/- .004)	Dim. L 2.6+/-0.1 (.102+/- .004)	Dim. L 1.2+/-0.1 (.047+/- .004)	Dim. L 2.6+/-0.1 (.102+/- .004)
4	4.0 [.157]	2.0 [.079]	1734506-1	2-1734506-5	5-1734506-1	7-1734506-5
6	6.0 [.236]	4.0 [.157]	1734506-2	2-1734506-6	5-1734506-2	7-1734506-6
8	8.0 [.315]	6.0 [.236]	1734506-3	2-1734506-7	5-1734506-3	7-1734506-7
10	10.0 [.394]	8.0 [.315]	1734506-4	2-1734506-8	5-1734506-4	7-1734506-8
12	12.0 [.472]	10.0 [.394]	1734506-5	2-1734506-9	5-1734506-5	7-1734506-9
14	14.0 [.551]	12.0 [.472]	1734506-6	3-1734506-0	5-1734506-6	8-1734506-0
16	16.0 [.630]	14.0 [.551]	1734506-7	3-1734506-1	5-1734506-7	8-1734506-1
18	18.0 [.709]	16.0 [.630]	1734506-8	3-1734506-2	5-1734506-8	8-1734506-2
20	20.0 [.787]	18.0 [.709]	1734506-9	3-1734506-3	5-1734506-9	8-1734506-3
22	22.0 [.866]	20.0 [.787]	1-1734506-0	3-1734506-4	6-1734506-0	8-1734506-4
24	24.0 [.945]	22.0 [.866]	1-1734506-1	3-1734506-5	6-1734506-1	8-1734506-5
26	26.0 [1.024]	24.0 [.945]	1-1734506-2	3-1734506-6	6-1734506-2	8-1734506-6
28	28.0 [1.102]	26.0 [1.024]	1-1734506-3	3-1734506-7	6-1734506-3	8-1734506-7
30	30.0 [1.181]	28.0 [1.102]	1-1734506-4	3-1734506-8	6-1734506-4	8-1734506-8
32	32.0 [1.260]	30.0 [1.181]	1-1734506-5	3-1734506-9	6-1734506-5	8-1734506-9
34	34.0 [1.339]	32.0 [1.260]	1-1734506-6	4-1734506-0	6-1734506-6	9-1734506-0
36	36.0 [1.417]	34.0 [1.339]	1-1734506-7	4-1734506-1	6-1734506-7	9-1734506-1
38	38.0 [1.496]	36.0 [1.417]	1-1734506-8	4-1734506-2	6-1734506-8	9-1734506-2
40	40.0 [1.575]	38.0 [1.496]	1-1734506-9	4-1734506-3	6-1734506-9	9-1734506-3
42	42.0 [1.654]	40.0 [1.575]	2-1734506-0	4-1734506-4	7-1734506-0	9-1734506-4
44	44.0 [1.732]	42.0 [1.654]	2-1734506-1	4-1734506-5	7-1734506-1	9-1734506-5
46	46.0 [1.811]	44.0 [1.732]	2-1734506-2	4-1734506-6	7-1734506-2	9-1734506-6
48	48.0 [1.890]	46.0 [1.811]	2-1734506-3	4-1734506-7	7-1734506-3	9-1734506-7
50	50.0 [1.969]	48.0 [1.890]	2-1734506-4	4-1734506-8	7-1734506-4	9-1734506-8
40*	40.0 [1.575]	38.0 [1.496]	—	4-1734506-9	—	9-1734506-9

\*Keying position 6.

**Note:** All part numbers are RoHS compliant.

## 2mm Receptacle, Double Row, Surface Mount, Right-Angle Mount

### Receptacle, Surface Mount, Right-Angle

#### Material and Finish

**Housing** — Black Thermoplastic, UL 94V-0 Rated

**Contact** — Phosphor Bronze

**Contact Finish** — 0.00020 [.000008]

Min. Gold Plated on Contact Area, 0.00229 [.000090] Min. Tin Plated on Solder Tail, 0.00127 [.000050] Min. Nickel Underplated Over All

#### Related Product Data

**Mateable Headers** — pages 66-73

**Product Specification**  
108-57197

**Packaging Method** — Tape and reel

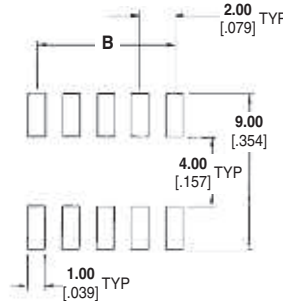
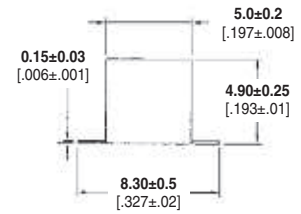
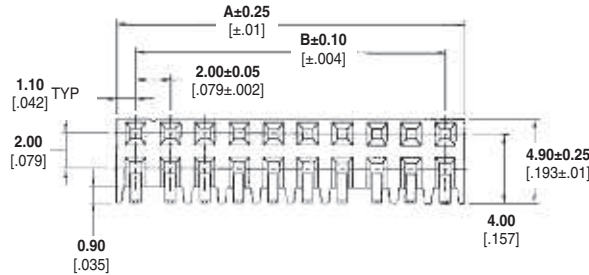
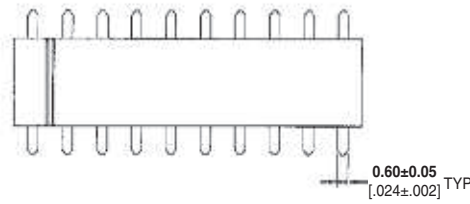

Recommended PCB Layout

Position	Dimensions		Part Numbers
	A	B	
6	6.20 [.244]	4.0 [.157]	1734606-6
8	8.20 [.323]	6.0 [.236]	1734606-8
10	10.20 [.402]	8.0 [.315]	1-1734606-0
12	12.20 [.480]	10.0 [.394]	1-1734606-2
14	14.20 [.559]	12.0 [.472]	1-1734606-4
16	16.20 [.638]	14.0 [.551]	1-1734606-6
18	18.20 [.717]	16.0 [.630]	1-1734606-8
20	20.20 [.795]	18.0 [.709]	2-1734606-0
22	22.20 [.874]	20.0 [.787]	2-1734606-2
24	24.20 [.953]	22.0 [.866]	2-1734606-4
26	26.20 [1.031]	24.0 [.945]	2-1734606-6
28	28.20 [1.110]	26.0 [1.024]	2-1734606-8
30	30.20 [1.189]	28.0 [1.102]	3-1734606-0
32	32.20 [1.268]	30.0 [1.181]	3-1734606-2
34	34.20 [1.346]	32.0 [1.260]	3-1734606-4
36	36.20 [1.425]	34.0 [1.339]	3-1734606-6
38	38.20 [1.504]	36.0 [1.417]	3-1734606-8
40	40.20 [1.583]	38.0 [1.496]	4-1734606-0
42	42.20 [1.661]	40.0 [1.575]	4-1734606-2
44	44.20 [1.740]	42.0 [1.654]	4-1734606-4
46	46.20 [1.819]	44.0 [1.732]	4-1734606-6
48	48.20 [1.898]	46.0 [1.811]	4-1734606-8
50	50.20 [1.976]	48.0 [1.890]	5-1734606-0

**Note:** All part numbers are RoHS compliant.

## 2mm Receptacle, Double Row, Thru-Hole, Right-Angle Mount

### Receptacle, Thru-Hole, Right-Angle

#### Material and Finish

**Housing** — Black Thermoplastic, UL 94V-0 Rated

**Contact** — Phosphor Bronze

**Contact Finish** — 0.00020 [.000008]

Min. Gold Plated on Contact Area, 0.00254 [.000100] Min. Tin Plated on Solder Tail, 0.00127 [.000050] Min. Nickel Underplated Over All

#### Related Product Data

**Mateable Headers** — pages 66-73

#### Product Specification

108-57197

**Packaging Method** — Tube

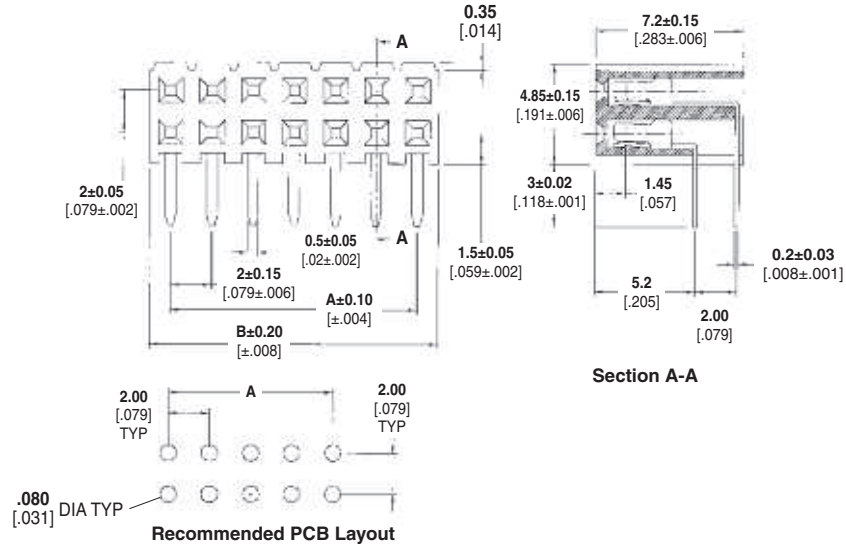

Position	Dimensions		Part Numbers
	A	B	
8	6.0 [.236]	8.50 [.335]	1734531-8
10	8.0 [.315]	10.50 [.413]	1-1734531-0
12	10.0 [.394]	12.50 [.492]	1-1734531-2
14	12.0 [.472]	14.50 [.571]	1-1734531-4
16	14.0 [.551]	16.50 [.650]	1-1734531-6
18	16.0 [.630]	18.50 [.728]	1-1734531-8
20	18.0 [.709]	20.50 [.807]	2-1734531-0
22	20.0 [.787]	22.50 [.886]	2-1734531-2
24	22.0 [.866]	24.50 [.965]	2-1734531-4
26	24.0 [.945]	26.50 [1.043]	2-1734531-6
28	26.0 [1.024]	28.50 [1.122]	2-1734531-8
30	28.0 [1.102]	30.50 [1.201]	3-1734531-0
32	30.0 [1.181]	32.50 [1.280]	3-1734531-2
34	32.0 [1.260]	34.50 [1.358]	3-1734531-4
36	34.0 [1.339]	36.50 [1.437]	3-1734531-6
38	36.0 [1.417]	38.50 [1.516]	3-1734531-8
40	38.0 [1.496]	40.50 [1.594]	4-1734531-0
42	40.0 [1.575]	42.50 [1.673]	4-1734531-2
44	42.0 [1.654]	44.50 [1.752]	4-1734531-4
46	44.0 [1.732]	46.50 [1.831]	4-1734531-6
48	46.0 [1.811]	48.50 [1.909]	4-1734531-8
50	48.0 [1.890]	50.50 [1.988]	5-1734531-0
52	50.0 [1.969]	52.50 [2.067]	5-1734531-2
54	52.0 [2.047]	54.50 [2.146]	5-1734531-4
56	54.0 [2.123]	56.50 [2.224]	5-1734531-6
58	56.0 [2.205]	58.50 [2.303]	5-1734531-8
60	58.0 [2.283]	60.50 [2.381]	6-1734531-0
62	60.0 [2.362]	62.50 [2.461]	6-1734531-2
64	62.0 [2.441]	64.50 [2.539]	6-1734531-4
66	64.0 [2.520]	66.50 [2.618]	6-1734531-6
68	66.0 [2.598]	68.50 [2.697]	6-1734531-8
70	68.0 [2.677]	70.50 [2.776]	7-1734531-0
72	70.0 [2.756]	72.50 [2.854]	7-1734531-2
74	72.0 [2.834]	74.50 [2.933]	7-1734531-4
76	74.0 [2.913]	76.50 [3.012]	7-1734531-6
78	76.0 [2.992]	78.50 [3.091]	7-1734531-8
80	78.0 [3.071]	80.50 [3.169]	8-1734531-0

**Note:** All part numbers are RoHS compliant.

## 2mm Receptacle, Double Row, Surface Mount, Vertical Mount

### Receptacle, Top Entry, Surface Mount

#### Material and Finish

**Housing**—Black Thermoplastic, UL 94V-0 Rated  
**Contact**—Copper Alloy, plated 0.00076 [.000030] Min. Gold Plated on Contact Area, 0.00254 [.000100] Tin Plated on Solder Tail, Underplated 0.00127 [.000050] Nickel  
**Cap**—Thermoplastic

#### Related Product Data

**Mateable Headers**—pages 66-75, 78, 79

**Product Specification**  
108-57227

**Packaging Method**—Tape and reel

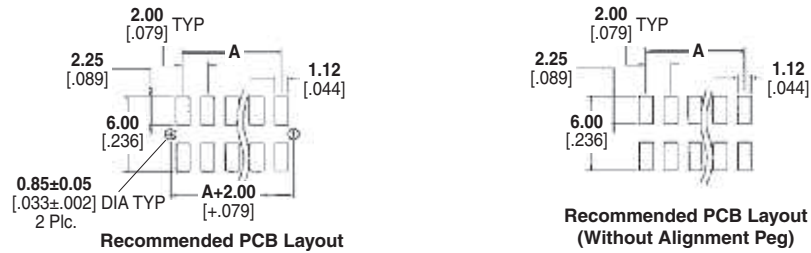
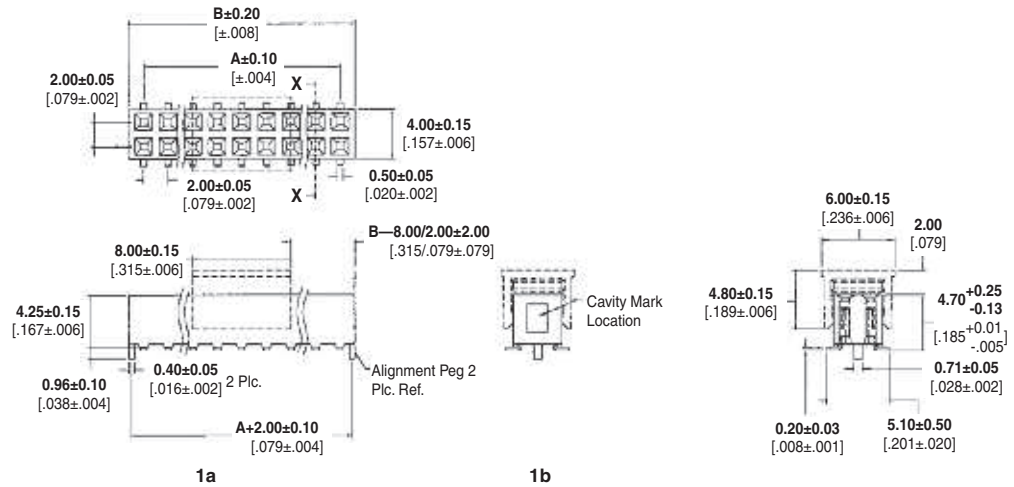

Position	Dimensions		245C Reflow Part Numbers		265C Reflow Part Numbers	
	A	B	with Alignment Peg*	without Alignment Peg	with Alignment Peg*	without Alignment Peg
8	6.0 [.236]	8.40 [.331]	1734516-8	5-1734516-8	2041069-8	5-2041069-8
10	8.0 [.315]	10.40 [.409]	1-1734516-0	6-1734516-0	1-2041069-0	6-2041069-0
12	10.0 [.394]	12.40 [.488]	1-1734516-2	6-1734516-2	1-2041069-2	6-2041069-2
14	12.0 [.472]	14.40 [.567]	1-1734516-4	6-1734516-4	1-2041069-4	6-2041069-4
16	14.0 [.551]	16.40 [.646]	1-1734516-6	6-1734516-6	1-2041069-6	6-2041069-6
18	16.0 [.630]	18.40 [.724]	1-1734516-8	6-1734516-8	1-2041069-8	6-2041069-8
20	18.0 [.709]	20.40 [.803]	2-1734516-0	7-1734516-0	2-2041069-0	7-2041069-0
22	20.0 [.787]	22.40 [.881]	2-1734516-2	7-1734516-2	2-2041069-2	7-2041069-2
24	22.0 [.866]	24.40 [.961]	2-1734516-4	7-1734516-4	2-2041069-4	7-2041069-4
26	24.0 [.945]	26.40 [1.039]	2-1734516-6	7-1734516-6	2-2041069-6	7-2041069-6
28	26.0 [1.024]	28.40 [1.118]	2-1734516-8	7-1734516-8	2-2041069-8	7-2041069-8
30	28.0 [1.102]	30.40 [1.197]	3-1734516-0	8-1734516-0	3-2041069-0	8-2041069-0
32	30.0 [1.181]	32.40 [1.276]	3-1734516-2	8-1734516-2	3-2041069-2	8-2041069-2
34	32.0 [1.260]	34.40 [1.354]	3-1734516-4	8-1734516-4	3-2041069-4	8-2041069-4
36	34.0 [1.339]	36.40 [1.433]	3-1734516-6	8-1734516-6	3-2041069-6	8-2041069-6
38	36.0 [1.417]	38.40 [1.512]	3-1734516-8	8-1734516-8	3-2041069-8	8-2041069-7
40	38.0 [1.496]	40.40 [1.591]	4-1734516-0	9-1734516-0	4-2041069-0	9-2041069-0

\*See views 1a and 1b

**Note:** All part numbers are RoHS compliant.

**AMPMODU .025 [0.64] Square Interconnection System**

**AMPMODU Headers and Receptacles, .100 [2.54] Centerline**

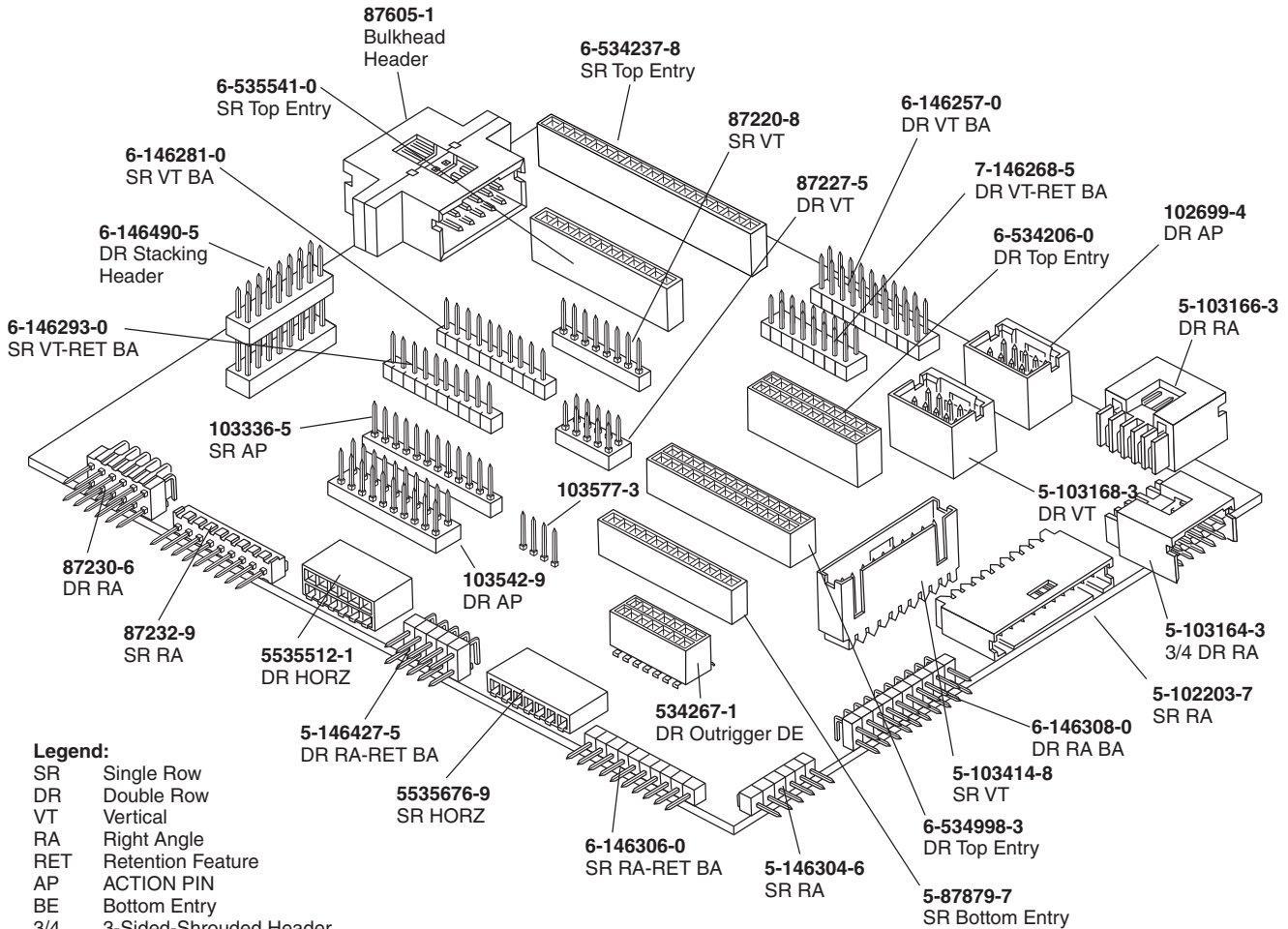

**Legend:**

- SR Single Row
- DR Double Row
- VT Vertical
- RA Right Angle
- RET Retention Feature
- AP ACTION PIN
- BE Bottom Entry
- 3/4 3-Sided-Shrouded Header
- BA Breakaway
- TR Triple Row
- SMT Surface Mount
- HORZ Horizontal
- DE Dual Entry

For drawings, technical data or samples, contact your TE sales engineer or call the TE Product Information Center: 1-800-522-6752

**Note:** All part numbers are RoHS compliant.

**AMPMODU .025 [0.64] Square Interconnection System (Continued)**

**AMPMODU Headers and Receptacles, .100 [2.54] Centerline**

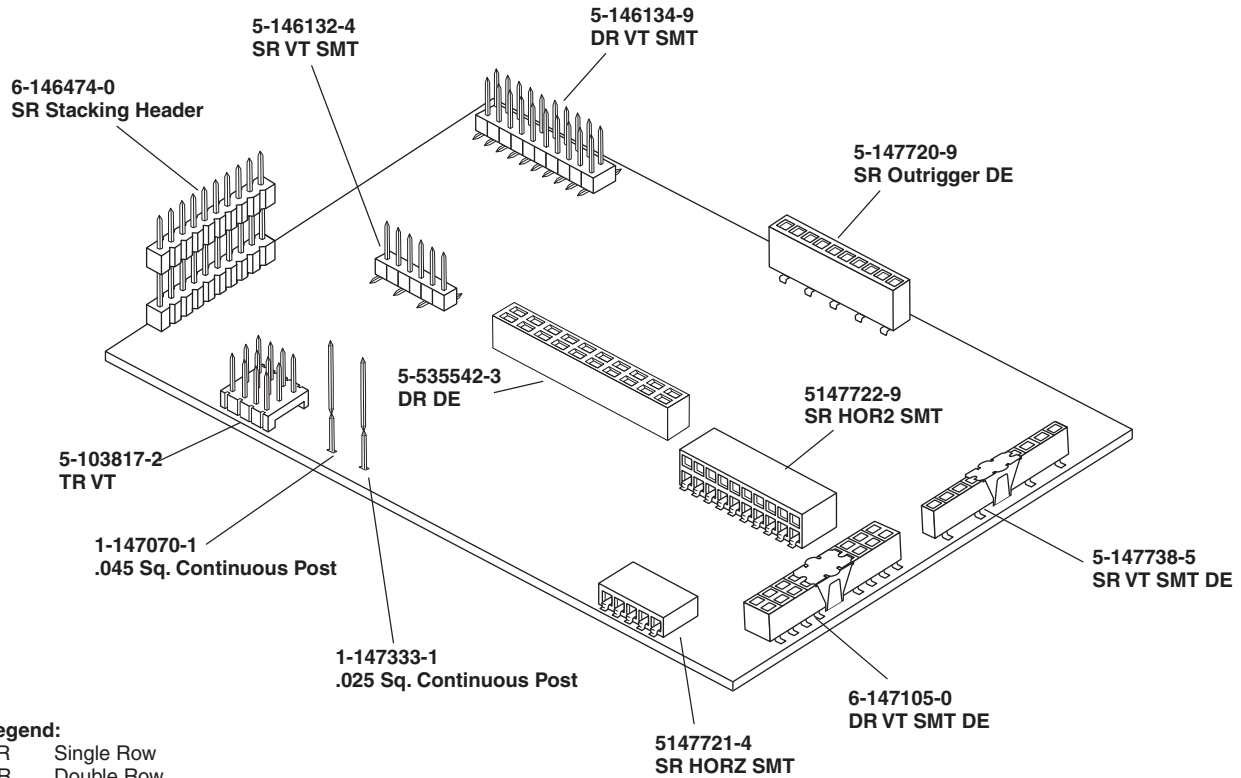

**Legend:**

- SR Single Row
- DR Double Row
- VT Vertical
- RA Right Angle
- RET Retention Feature
- AP ACTION PIN
- BE Bottom Entry
- 3/4 3-Sided-Shrouded Header
- BA Breakaway
- TR Triple Row
- SMT Surface Mount
- HORZ Horizontal
- DE Dual Entry

For drawings, technical data or samples, contact your TE sales engineer or call the TE Product Information Center: 1-800-522-6752

**Note:** All part numbers are RoHS compliant.

## AMPMODU .025 [0.64] Square Interconnection System

The AMPMODU interconnection system provides interconnections with a unique modular concept, utilizing precision formed receptacle contacts and mating posts.

Mating of the post and receptacle contacts of this system is very tolerant. This is made possible by a post with a burr-free lead-in and a receptacle contact featuring double cantilever beams and anti-overstress stops.

AMPMODU receptacle contacts and posts categorically fall into three general classifications of products, which include: board mounted posts and receptacle assemblies, post headers and wire-applied contact housings for crimp snap-in pin and receptacle contacts.

Board mounted receptacle assemblies are available in various geometries, offering packaging interconnections that include perpendicular, parallel and stacking capabilities.

Crimp snap-in pins for 26-22 AWG [0.12-0.4 mm<sup>2</sup>] wire and crimp snap-in receptacles for 32-20 AWG [0.03-0.6 mm<sup>2</sup>] wire provide excellent discrete wire terminations. Housings for these contacts provide ease of handling terminations in high density applications.

Machine applied terminations, through matched application equipment, are geared for virtually any production volume requirement, for the lowest possible applied cost.

AMPMODU mating posts are supplied typically as headers. They are available in various populations to meet the interconnection and packaging requirements of most systems. However, in instances where packaging configurations do not lend themselves to the economies of headers, TE can provide application equipment for the discrete location of individual posts.

Looking at the electronic industry's standard "levels of packaging," the AMPMODU .025 [0.64] square interconnection system is primarily used in levels three and four.

In level three it is used as a connection between two or more printed circuits. A mother/daughter board connection is typical. In level four it is used as a

connection between two subassemblies, such as a power supply and an associated subassembly.

It is also important to note this product can serve as an interconnection in more than one level, depending on the application.

The .025 [0.64] square interconnection system offers the most complete line of post/receptacle packaging products available today. This system, rated at 3 amperes per contact, has been used by almost every industry and marketplace over the last decade and is one of the oldest, most versatile and reliable interconnection systems employing .025 [0.64] square packaging technology.

### Receptacle Contacts

The AMPMODU receptacle cross-section is primarily rectangular, with rounded corners. Two integral cantilever beams contact the mating square or round male posts. Deflection of these spring members is limited by anti-overstress stops, and excessive permanent deformation is prevented. This feature allows a wide range for tolerance of misalignment of mating contacts.

The configuration of the receptacle completely encloses the spring members preventing damage during handling and assembly and makes the system compatible with automatic application techniques.

**Note:** Application of a contact lubricant is part of the manufacturing process of all AMPMODU tin-plated crimp products. However, it is not part of the manufacturing process of products that customers will solder, then clean. For these products, TE recommends that customers use contact lubricant. See the TE web page for further information.

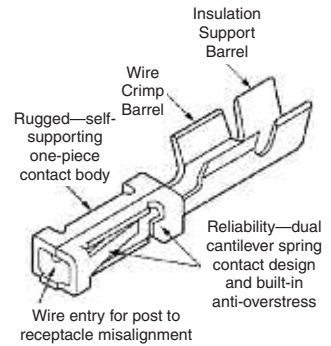

**Offers standard, intermediate and high pressure contact forces**

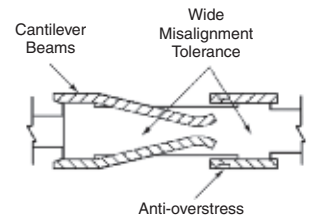

### Receptacle-Closed Entry Housing Design

The closed entry housing style better eliminates the chance of a mating post stubbing on the edges of the receptacle contact.

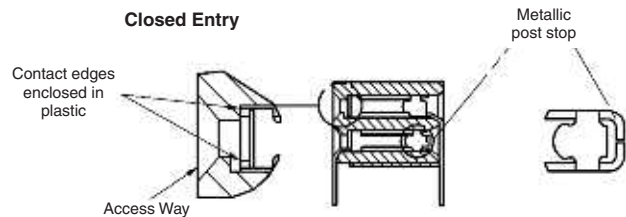
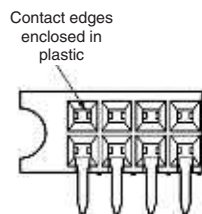

## Wire-to-Board, .100 [2.54] Centerline Products

### Wire Sizes

Wire Size		Product Family
AWG	[mm <sup>2</sup> ]	
20	0.5-0.6	Locking Clip, Mod. IV, IV.v, V, MT, Short Point
22-30	0.3-0.05	Locking Clip, Mod. IV, IV.v, V, MTE, MT, Short Point
32	0.03	Mod. IV, IV.v, V, Short Point

### Contact Platings

Platings	Product Family
<b>.000015</b> [0.00038] Gold	Mod. IV, IV.v, V, MTE, MT, Short Point
<b>.000030</b> [0.00076] Gold	Locking Clip, Mod. IV, IV.v, V, MTE, MT, Short Point
<b>.000050</b> [0.00127] Gold	Locking Clip, Mod. IV, IV.v, V, MT
Tin	Locking Clip, Mod. IV, IV.v, V, MTE, MT, Short Point

### Mating Post Lengths

Post Lengths	Product Family
<b>.210-.283</b> [5.33-7.19]	Mod. IV (.600 [15.24] Profile Height)
<b>.205-.283</b> [5.21-7.19]	Mod. IV.v (.600 [15.24] Profile Height)
<b>.185-.283</b> [4.70-7.19]	Mod. V (.600 [15.24] Profile Height)
<b>.256-.323</b> [6.50-8.20]	Mod. IV (.645 [16.38] Profile Height)
<b>.251-.323</b> [6.38-8.20]	Mod. IV.v (.645 [16.38] Profile Height)
<b>.231-.323</b> [5.87-8.20]	Mod. V (.645 [16.38] Profile Height)
<b>.222-.273</b> [5.64-6.93]	MT Assembly with Standard Pressure Contacts
<b>.200-.273</b> [5.08-6.93]	MT Assembly with High Pressure Contacts
<b>.200-.250</b> [5.08-6.35]	MTE Assembly
<b>.169-.259</b> [4.29-6.58]	Short Point Connector Assembly
<b>.273-.350</b> [6.93-8.89]	Locking Clip (Connector Assembly)
<b>.200-.277</b> [5.08-7.04]	Locking Clip (Single Contact)

### Application Tooling

Application Tooling Description	Product Family					
	Mod. IV, IV.v, V	MT	Locking Clip	MTE	Short Point	Level V
Manual Hand Tools (Wire Crimp)	•		•	•	•	
Manual Hand Tools (IDC)		•		•		•
AMP-O-MATIC Stripper/Crimper Machines with Applicator	•		•		•	
CHAMPOMATOR Model 2.5 Machine		•				•
CHAMPOMATOR Model 3A Machine		•				
AMP-O-LECTRIC Machines with Applicator	•		•		•	
Pneumatic Hand Tools	•	•	•	•	•	•
IDC Electric Power Unit				•		
Tube-Fed Ribbon Cable Machine				•		
AMPOMATOR CLS Machines	•		•		•	
Discrete Wire Machine		•				•
Manual Arbor Tool		•				•
Pneumatic Arbor Tool		•				•



## Board-to-Board Solutions Guide, .100 [2.54] Centerline Products

Problem or Concern	TE's Potential Solution	Single-Row Vertical Headers and Receptacles (Page Ref.)	Single-Row Right-Angle Headers, Horizontal Receptacles (Page Ref.)	Double-Row Vertical Headers and Receptacles (Page Ref.)	Double-Row Right-Angle Headers, Horizontal Receptacles (Page Ref.)	
Headers Float Off Board Soldering Operation	<b>HEADERS</b> Retention Feature: Unshrouded Shrouded	102 —	103 —	198 104, 199	199 105, 200	
Header Contacts Damaged During Manufacturing Operation or In-Field Use	Shrouded <b>HEADERS</b> : Standard Profile	115	116	117-121	122-128	
Board/Backplane Requires High Temperature Surface-Mount Compatibility	Press-Fit ACTION PIN POST					
	<b>HEADERS</b> : Unshrouded Shrouded	146 —	— —	147 148, 149, 199	— —	
	Machine Applied Posts	163, 164				
Application Requires Board Guidance, Polarization and/or Blind-Mate Capability	Surface-Mount Compatible Thru-Hole: <b>HEADERS</b> : Unshrouded Shrouded (Low Profile) <b>RECEPTACLES</b>	102* — —	103* — —	104* 130*, 137*	105* 138* 195*	
	Surface-Mount: <b>HEADERS</b> <b>RECEPTACLES</b>	109* 187, 188	— 172	110 189-192	— 173	
	Two-Piece Family: w/Guide Posts: <b>HEADERS</b> <b>RECEPTACLES</b>	— —	— —	198, 199 196*	200 195*	
Reduction in Parallel Board-to-Board Stack Height Necessary (Refer to Parallel Stack Guide on Page 62.)	Mod IV Low Profile <b>RECEPTACLES</b> : <b>TOP ENTRY</b> : Thru-Hole Surface-Mount <b>BOTTOM ENTRY</b> : Thru-Hole Surface-Mount <b>DUAL ENTRY</b> : Thru-Hole Surface Mount	178 — — 177 — 181 187, 188	— — — — — —	179, 180* — — — — 182-184 189-192	— — — — — —	
	Soldering Problems with Thru-Hole Bottom Entry Receptacles (Must Mask Post Holes in Board During Soldering Operation)	<b>RECEPTACLES</b> : Bottom Entry Outrigger (Separate Holes for Receptacle Leads and Mating Leads)	181	—	182	—
	Application Requires Connectors to be End-to-End Stackable on .100 [2.54] Grid	End-to-End Stackable: <b>HEADERS</b> (Unshrouded): Thru-Hole Thru-Hole* Surface-Mount <b>RECEPTACLES</b> : Thru-Hole Surface Mount	93, 102 102* 109* 175, 177, 178, 181 188	94, 95, 103* 103* — 169* 172	96, 97, 104* 104* 110* 176, 179, 180*, 182*, 183, 184 191, 192	98, 99, 105 108* — 170 173

\*High temperature compatible version, refer to page ref. listed.

## Wire-to-Board Solutions Guide, .100 [2.54] Centerline Products

Customer Requirement	TE's Potential Solution	Catalog Page(s)
Application Requires Guidance, Polarization	Mod IV Polarized Housing	220
	MTE Latched Receptacle and Header	230, 231, 244-250
	MT with Polarizing Covers	256-258
Wire-to-Wire Application	Short Point Polarized Housing	224
	Mod IV Receptacle Contacts and Pins	211-213
Wire-to-Wire Application (Latched)	MTE Latched Receptacle and Shrouded Pin Assembly	230, 231, 236, 237
Wire-to-Wire Application (Through Panel)	MTE Panel Mount	242
High Vibration and Shock Applications	Locking Clip Contacts and Housings	207-209
Printed Circuit Board Polarization	MTE Header with PC Board Orientation Peg	248, 249
Board Requires Surface Mount Capability	MTE Surface Mount Headers	251, 252
	MTE High Temperature Compatible Headers	249, 250
Need to mate to AMP-LATCH Eject Headers	Mod IV Ejection Housing	220
Need to Minimize Strain to Cable	MT with Eject Covers	256-259
	Mod IV Housing with Strain Relief	218, 219
Application Requires Self-Retaining Contacts	Locking Clip Contacts	207, 298
Header Secured to Board During/Prior to Soldering	MTE Headers with Post Retention or Holddowns	244-250
Mate to Unshrouded Header with Retention Requirements	Mod IV plain Housing with Mod V Contacts	213, 214, 216
	MTE with High Pressure Contacts	234, 235
Multiple Cables to be Common to One Header	MTE Coupling Shroud, Double- or Single-Row	240, 241
Right-Angle Cable Dress	MT with Hermaphroditic Covers	229, 256, 257, 259
Application Requires Crimp Contacts and MTE Housings	Short Point Contacts	222
Housings and End-to-End and Side-to-Side Stackable	Short Point Double-Row Housing, MTE Plain Housing	223, 228, 229
Connector Must Mate to Post Lengths of .169 [4.29] Min.	Short Point Contacts	222

## Mating Post Selection Guide

The following selection guide is provided to help in choosing a mating product after a receptacle, header or post has been selected.

In some instances references are given on the catalog page to specific mating connectors. In other instances the reader is referred here to the selection guide for mating product recommendations.

If your application requirement is not answered here, consult TE for further recommendations.

### Posts Without Shoulders

For drawn wire products (ie, AMPMODU Breakaway and Low Profile Headers) and for products having the shoulder of the post below the housing or pc board surface (ie, AMPMODU MTE and Single Row Shrouded Headers) the effective mating length starts at the housing or pc board surface.

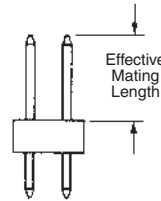

### Posts With Shoulders

For product having the shoulder of the post extending above the housing or pc board surface (ie, Standard AMPMODU Shrouded and Unshrouded Headers) the effective mating length starts at the top of the shoulder.

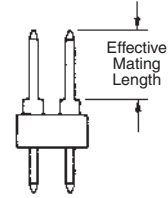

Receptacle Type	Recommended Effective Mating Posts Lengths	
	Minimum	Maximum
AMPMODU Mod II Horizontal Board Mount Receptacle, Single and Double Row, Short Point-of-Contact—pages 169, 170, 172, 173	.230 [5.84]	.280 [7.11]
AMPMODU Mod II Vertical Board Mount Receptacle, Single Row, Standard Profile, Top Entry—page 175	.183 [4.65]	.330 [8.38]
AMPMODU Mod II Vertical Board Mount Receptacle, Standard Profile, Double Row, Top Entry, 100 x .100 mt.—page 176	.183 [4.65]	.330 [8.38]
AMPMODU Mod IV Vertical Board Mount Receptacle, Low Profile, Single Row, Top Entry, Single Tine—page 178	.183 [4.65]	.255 [6.48]
AMPMODU Mod IV Vertical Board Mount Receptacle, Low Profile, Single Row, Bottom Entry—page 177	.280 [7.11]	*
AMPMODU Mod IV Vertical Board Mount Receptacle, Low Profile, Double Row, Top Entry—pages 179, 180	.183 [4.65]	.255 [6.48]
AMPMODU Surface-Mount Receptacle, Vertical Board Mount, Single Row, Dual Entry—page 187, 188	Top Entry .183 [4.65] Bottom Entry .204 [5.18]	* *
AMPMODU Mod IV Vertical Board Mount Receptacle, Low Profile, Double Row, Dual Entry—page 182	Top Entry .183 [4.65] Bottom Entry .204 [5.18]	* *
AMPMODU Surface-Mount Receptacle, Vertical Board Mount, Double Row, Dual Entry—page 189-192	Top Entry .183 [4.65] Bottom Entry .204 [5.18]	* *
AMPMODU .600 [15.24] Mod IV Housing with Standard Pressure Contacts—pages 211-220	.210 [5.33]	.283 [7.19]
AMPMODU .600 [15.24] Mod IV Housing with Intermediate Pressure Contacts—pages 211-220	.205 [5.21]	.283 [7.19]
AMPMODU .600 [15.24] Mod IV Housing with High Pressure Contacts—pages 211-220	.185 [4.70]	.283 [7.19]
AMPMODU Mod IV Vertical Board Mount Receptacle, Low Profile, Single Row, Dual Entry—page 181	Top Entry .183 [4.65] Bottom Entry .204 [5.18]	* *

Receptacle Type	Recommended Effective Mating Posts Lengths	
	Minimum	Maximum
Short Point Housing with Contacts—pages 222-224	.169 [4.29]	.259 [6.58]
AMPMODU MTE Unloaded Housing with Short Point Contacts—pages 222, 229, 231, 233	.169 [4.29]	.259 [6.58]
AMPMODU MTE IDC Assemblies	.200 [5.08]	.250 [6.35]
AMPMODU MT IDC Assembly with Standard Pressure Contacts—page 256	.222 [5.64]	.273 [6.93]
AMPMODU MT IDC Assembly with High Pressure Contacts—page 257	.200 [5.08]	.273 [6.93]
Locking Clip Housing with Contacts—pages 207-209	.273 [6.93]	.350 [8.89]
Locking Clip Contact without Housing—page 207	.200 [5.08]	.277 [7.04]
Flexible Flat Conductor Cable Receptacle with Round Wire Crimp High Pressure Contact—Catalog 82007	Single Row	.267 [6.78] .323 [8.20]
	Double Row	.282 [7.16] .323 [8.20]
Flexible Flat Conductor Cable Receptacle with Multiple Wire Crimp High Pressure Contact—Catalog 82007	Single Row	.210 [5.33] .323 [8.20]
	Double Row	.225 [5.72] .323 [8.20]
Flexible Flat Conductor Cable Receptacle with Round Wire Crimp Standard Pressure Contact—Catalog 82007	Single Row	.267 [6.78] .323 [8.20]
	Double Row	.282 [7.16] .323 [8.20]
Flexible Flat Conductor Cable Receptacle with Multiple Crimp Standard Pressure Contact—Catalog 82007	Single Row	.220 [5.59] .323 [8.20]
	Double Row	.235 [5.97] .323 [8.20]

\*Maximum post length is determined by customer's application; (i.e., available space beyond rear of horizontal receptacle assembly, or above bottom entry vertical receptacle assembly or below vertical receptacle assemblies used in pass through applications).

## Parallel Stacking Guide for Board-to-Board Applications

See Figure Below	Dimension Between PC Boards	Product Family Headers (See Note 1.)	Single-Row (Page Ref.)	Double-Row (Page Ref.)	Product Family Receptacles	Single-Row (Page Ref.)	Double-Row (Page Ref.)
	.060 [1.52]	Bandolier Posts	163	NA	Dual Entry, Mod IV	177, 181, 187, 188	182-184, 189-192
1	.090 [2.29]	Breakaway** (Unshrouded)	102**	104**	Dual Entry, Mod IV	177, 181, 187, 188	182-184, 189-192
	.153 [3.89]	Surface Mount** Breakaway (Unshrouded)	NA	110	Dual Entry, Mod IV	177, 181, 187, 188	182-184, 189-192
	.265 [6.73]	Bandolier Posts	163	137**	Top Entry, Mod IV	178, 181, 187, 188	179, 180, 182-184, 189-192
2	.355 [9.02]	Breakaway** (Unshrouded)	102**	104**	Top Entry, Mod IV	178, 181, 187, 188	179, 180, 182-184, 189-192
	.385 [9.78]	Low Profile Shrouded	NA	135, 137**	Top Entry, Mod IV	NA	179, 180
3	.418 [10.6]	Surface Mount** Breakaway (Unshrouded)	109	110	Surface Mount**, Mod IV, Top Entry	187, 188	189-192
2*	.430 [10.92]	Breakaway** (Unshrouded)	102**	104**	Top Entry, Mod II	175	176
4*	.440 [11.18]	Shrouded, Mod II	115, 116	117, 119	Top Entry, Mod II or Mod IV	175, 178	176, 179, 180
	.528 [13.41]	Stacking Shroud (See Note 2.)	NA	156 (Hood)	Inner Board Receptacle (See Note 2.)	NA	157
	.547 [13.89]	Stacking Shroud (See Note 2.)	NA	160	Outer Board Receptacle (See Note 2.)	NA	158
4	.550 [13.97]	Two-Piece Header Connector System	NA	198, 199	Two-Piece Receptacle** Connector System	NA	196**
	.748 [19.00]	Stacking Shroud (See Note 2.)	NA	156 (Hood)	Inner Board Receptacle (See Note 2.)	NA	157
	.768 [19.51]	Stacking Shroud (See Note 2.)	NA	161	Outer Board Receptacle (See Note 2.)	NA	158
	Various	Stacking Unshrouded	112	113	Mod II/IV Receptacles, Top/Bottom Entry	Various	Various

\*\*High temperature version available, see page ref. listed.

**Notes:** 1. Headers listed are standard thru-hole versions. Many headers are available with retention feature and ACTION PIN posts. See product specification pages in individual sections for option availability.

2. These headers and receptacles are Related Board-to-Board products. They are not part of the AMPMODU .025 [0.64] Square Product Family.

### Board-to-Board Stacking Heights (By Receptacle/Header Combination)

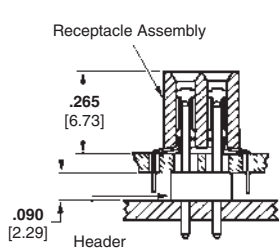

**Figure 1**  
Double-Row, Mod IV, Bottom Entry, Breakaway Header

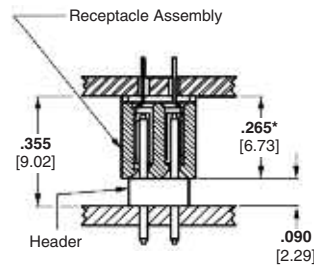

**Figure 2**  
Double-Row, Mod IV, Top Entry, Breakaway Header  
\*Mod II Receptacle Height is .340 [8.64] for a total stack height of .430 [10.92]

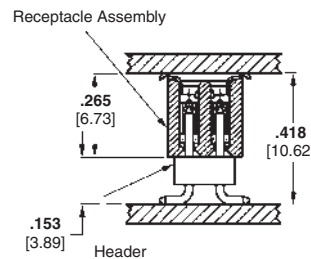

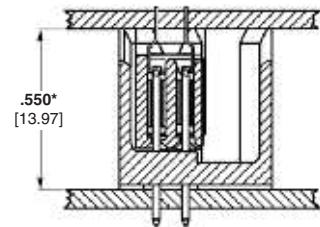

**Figure 3**  
Double-Row, Mod IV, Surface-Mount, Top Entry, Receptacle and Surface-Mount Breakaway Header

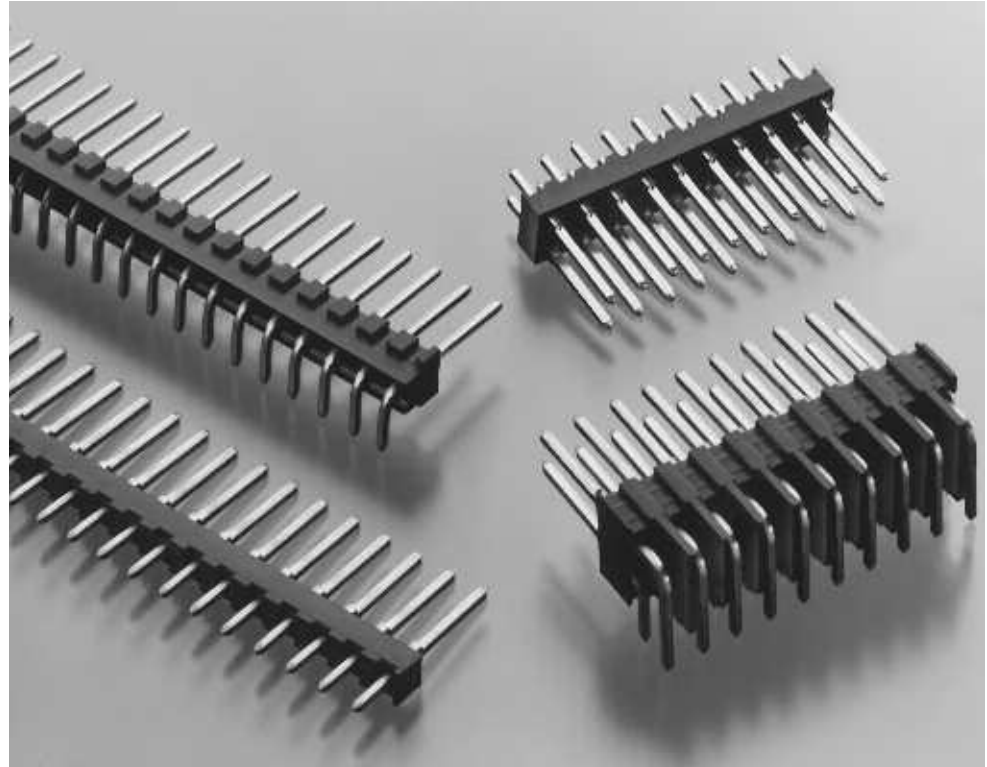

**Figure 4**  
Double-Row, Two-Piece Receptacle and Two-Piece Shrouded Header  
\*Mod II Shrouded Header Height is .440 [11.18] for a total stack height of .440 [11.18]

## Standard Headers—Unshrouded

### Product Facts

- Variety of popular sizes available
- Substantial time/labor savings—install all posts at one time
- Vertical and right-angle versions available in single- and double-row configurations
- Triple-row version available in vertical configuration with .230 [5.84] mating length
- Copper alloy posts
- Choice of select gold or tin plated posts
- Mating length for single and double row is .318 [8.08] (.278 [7.06] effective mating length—see page 90)
- Flame retardant, black thermoplastic housings; 94V-0 rated
- Recognized under the Component Program of Underwriters Laboratories Inc., File No. E28476 
- Certified by Canadian Standards Association, File No. LR 7189 



### Performance Characteristics

#### Electrical

**Insulation Resistance** — 5,000 megohms minimum initial

**Dielectric Withstanding Voltage** — 750 V rms at sea level

#### Environmental

**Operating Temperature** — -65°C to +105°C (black thermoplastic housings)

**Current** — 3 amperes maximum per contact (dependent upon mating connector)

## Standard Headers—Unshrouded, Single Row, .100 [2.54] Centerline

### .025 [0.64] Square Straight Post

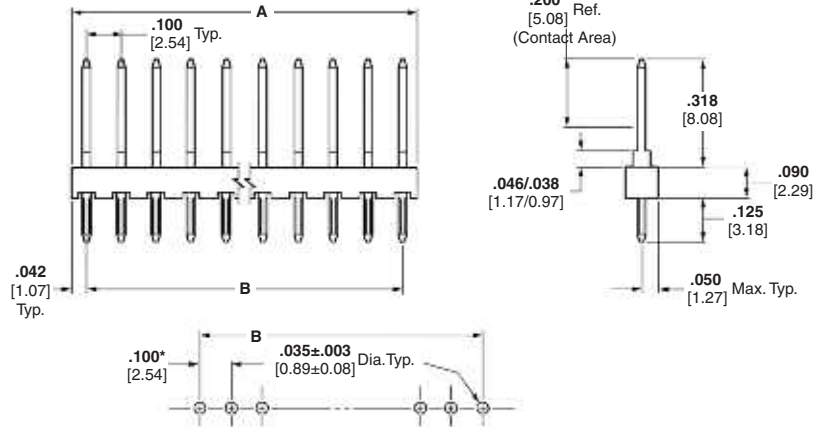

**Recommended PC Board Hole Layout  
(for .055 [1.40] min. thick PC board)**

\*±.003 [±0.08] tolerances not to accumulate within one connector pattern.

### Material and Finish

**Housing** — Black thermoplastic, 94V-0 rated

**Posts** — Copper alloy, plated as follows:

**Plating A** — Selectively plated .000030 [0.00076] gold on contact area, with gold flash over .000050 [0.00127] nickel on entire post

**Plating B** — Selectively plated .000015 [0.00038] gold on contact area, with gold flash over .000050 [0.00127] nickel on entire post

**Tin/Nickel** — Plating option available; minimum order quantities may apply. Consult TE.

### Related Product Data

**Mateable Connectors** — Refer to the Mating Post Selection Guide — page 90

### Technical Documents — page 276

See mating connector for applicable product and application specifications.

No. of Pos.	Dimensions		Post Plating/Part Nos.	
	A	B	Plating A	Plating B
1	.084 [2.13]	—	87220-1	87224-1
2	.184 [4.67]	.100 [2.54]	87220-2	87224-2
3	.284 [7.21]	.200 [5.08]	87220-3	87224-3
4	.384 [9.75]	.300 [7.62]	87220-4	87224-4
5	.484 [12.29]	.400 [10.16]	87220-5	87224-5
6	.584 [14.83]	.500 [12.70]	87220-6	87224-6
7	.684 [17.37]	.600 [15.24]	87220-7	87224-7
8	.784 [19.91]	.700 [17.78]	87220-8	87224-8
9	.884 [22.45]	.800 [20.32]	87220-9	87224-9
10	.984 [24.99]	.900 [22.86]	1-87220-0	1-87224-0
11	1.084 [27.53]	1.000 [25.40]	1-87220-1	1-87224-1
12	1.184 [30.07]	1.100 [27.94]	1-87220-2	1-87224-2
13	1.284 [32.61]	1.200 [30.48]	1-87220-3	1-87224-3
14	1.384 [35.15]	1.300 [33.02]	1-87220-4	1-87224-4
15	1.484 [37.69]	1.400 [35.56]	1-87220-5	1-87224-5
16	1.584 [40.23]	1.500 [38.10]	1-87220-6	1-87224-6
17	1.684 [42.77]	1.600 [40.64]	1-87220-7	1-87224-7
18	1.784 [45.31]	1.700 [43.18]	1-87220-8	1-87224-8
19	1.884 [47.85]	1.800 [45.72]	1-87220-9	1-87224-9
20	1.984 [50.39]	1.900 [48.26]	2-87220-0	2-87224-0
21	2.084 [52.93]	2.000 [50.80]	2-87220-1	2-87224-1
22	2.184 [55.47]	2.100 [53.34]	2-87220-2	2-87224-2
23	2.284 [58.01]	2.200 [55.88]	2-87220-3	2-87224-3
24	2.384 [60.55]	2.300 [58.42]	2-87220-4	2-87224-4
25	2.484 [63.09]	2.400 [60.96]	2-87220-5	2-87224-5
26	2.584 [65.63]	2.500 [63.50]	2-87220-6	2-87224-6
27	2.684 [68.17]	2.600 [66.04]	2-87220-7	2-87224-7
28	2.784 [70.71]	2.700 [68.58]	2-87220-8	2-87224-8
29	2.884 [73.25]	2.800 [71.12]	2-87220-9	2-87224-9
30	2.984 [75.79]	2.900 [73.66]	3-87220-0	3-87224-0
31	3.084 [78.33]	3.000 [76.20]	3-87220-1	3-87224-1
32	3.184 [80.87]	3.100 [78.74]	3-87220-2	3-87224-2
33	3.284 [83.41]	3.200 [81.28]	3-87220-3	3-87224-3
34	3.384 [85.95]	3.300 [83.82]	3-87220-4	3-87224-4
35	3.484 [88.49]	3.400 [86.36]	3-87220-5	3-87224-5
36	3.584 [91.03]	3.500 [88.90]	3-87220-6	3-87224-6
37	3.684 [93.57]	3.600 [91.44]	3-87220-7	3-87224-7
38	3.784 [96.11]	3.700 [93.98]	3-87220-8	3-87224-8
39	3.884 [98.65]	3.800 [96.52]	3-87220-9	3-87224-9
40	3.984 [101.19]	3.900 [99.06]	4-87220-0	4-87224-0

**Note:** All part numbers are RoHS compliant.

**Standard Headers—Unshrouded, Single Row, .100 [2.54] Centerline** (Continued)

**.025 [0.64] Square Right-Angle Post**

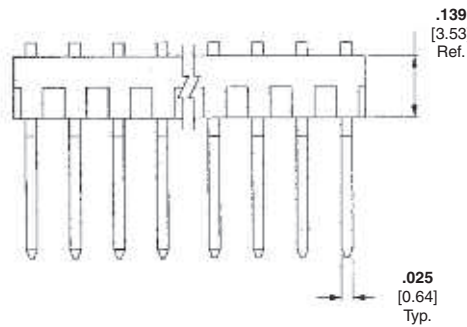

**Material and Finish**

**Housing** — Black thermoplastic, 94V-0 rated

**Posts** — Copper alloy, plated as follows:

**Plating A** — Selectively plated .000030 [0.00076] gold on contact area, with gold flash over .000050 [0.00127] nickel on entire post

**Plating B** — Selectively plated .000015 [0.00038] gold on contact area, with gold flash over .000050 [0.00127] nickel on entire post

**Tin/Nickel** — Plating option available; minimum order quantities may apply. Consult TE.

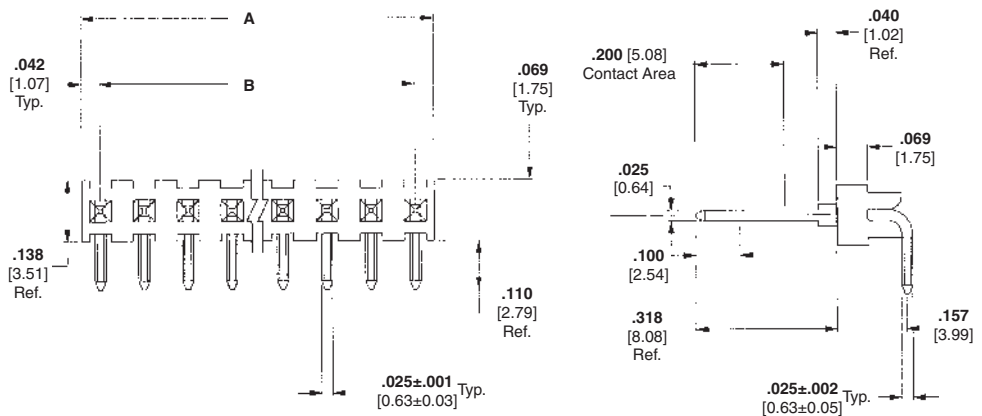

**Related Product Data**

**Mateable Connectors** — Refer to the Mating Post Selection Guide — page 90



**Recommended PC Board Hole Layout**  
(for .055 [1.40] min. thick PC board)

\*±.003 [±0.08] tolerances not to accumulate within one connector pattern.

**Technical Documents** — page 276

See mating connector for applicable product and application specifications.

No. of Pos.	Dimensions		Post Plating/Part Nos.	
	A	B	Plating A	Plating B
1	.084 [2.13]	—	87232-1	87233-1
2	.184 [4.67]	.100 [2.54]	87232-2	87233-2
3	.284 [7.21]	.200 [5.08]	87232-3	87233-3
4	.384 [9.75]	.300 [7.62]	87232-4	87233-4
5	.484 [12.29]	.400 [10.16]	87232-5	87233-5
6	.584 [14.83]	.500 [12.70]	87232-6	87233-6
7	.684 [17.37]	.600 [15.24]	87232-7	87233-7
8	.784 [19.91]	.700 [17.78]	87232-8	87233-8
9	.884 [22.45]	.800 [20.32]	87232-9	87233-9
10	.984 [24.99]	.900 [22.86]	1-87232-0	1-87233-0
11	1.084 [27.53]	1.000 [25.40]	1-87232-1	1-87233-1
12	1.184 [30.07]	1.100 [27.94]	1-87232-2	1-87233-2
13	1.284 [32.61]	1.200 [30.48]	1-87232-3	1-87233-3
14	1.384 [35.15]	1.300 [33.02]	1-87232-4	1-87233-4
15	1.484 [37.69]	1.400 [35.56]	1-87232-5	1-87233-5
16	1.584 [40.23]	1.500 [38.10]	1-87232-6	1-87233-6
17	1.684 [42.77]	1.600 [40.64]	1-87232-7	1-87233-7
18	1.784 [45.31]	1.700 [43.18]	1-87232-8	1-87233-8
19	1.884 [47.85]	1.800 [45.72]	1-87232-9	1-87233-9
20	1.984 [50.39]	1.900 [48.26]	2-87232-0	2-87233-0

**Note:** All part numbers are RoHS compliant.

**Standard Headers—Unshrouded, Single Row, .100 [2.54] Centerline** (Continued)

No. of Pos.	Dimensions		Post Plating/Part Nos.	
	A	B	Plating A	Plating B
21	2.084 [52.93]	2.000 [50.80]	2-87232-1	2-87233-1
22	2.184 [55.47]	2.100 [53.34]	2-87232-2	2-87233-2
23	2.284 [58.01]	2.200 [55.88]	2-87232-3	2-87233-3
24	2.384 [60.55]	2.300 [58.42]	2-87232-4	2-87233-4
25	2.484 [63.09]	2.400 [60.96]	2-87232-5	2-87233-5
26	2.584 [65.63]	2.500 [63.50]	2-87232-6	2-87233-6
27	2.684 [68.17]	2.600 [66.04]	2-87232-7	2-87233-7
28	2.784 [70.71]	2.700 [68.58]	2-87232-8	2-87233-8
29	2.884 [73.25]	2.800 [71.12]	2-87232-9	2-87233-9
30	2.984 [75.79]	2.900 [73.66]	3-87232-0	3-87233-0
31	3.084 [78.33]	3.000 [76.20]	3-87232-1	3-87233-1
32	3.184 [80.87]	3.100 [78.74]	3-87232-2	3-87233-2
33	3.284 [83.41]	3.200 [81.28]	3-87232-3	3-87233-3
34	3.385 [85.95]	3.300 [83.82]	3-87232-4	3-87233-4
35	3.484 [88.49]	3.400 [86.36]	3-87232-5	3-87233-5
36	3.584 [91.03]	3.500 [88.90]	3-87232-6	3-87233-6
37	3.684 [93.57]	3.600 [91.44]	3-87232-7	3-87233-7
38	3.784 [96.11]	3.700 [93.98]	3-87232-8	3-87233-8
39	3.884 [98.65]	3.800 [96.52]	3-87232-9	3-87233-9
40	3.984 [101.19]	3.900 [99.06]	4-87232-0	4-87233-0

**Note:** All part numbers are RoHS compliant.

## Standard Headers—Unshrouded, Double-Row, .100 x .100 [2.54 x 2.54] Centerline

### .025 [0.64] Square Straight Post

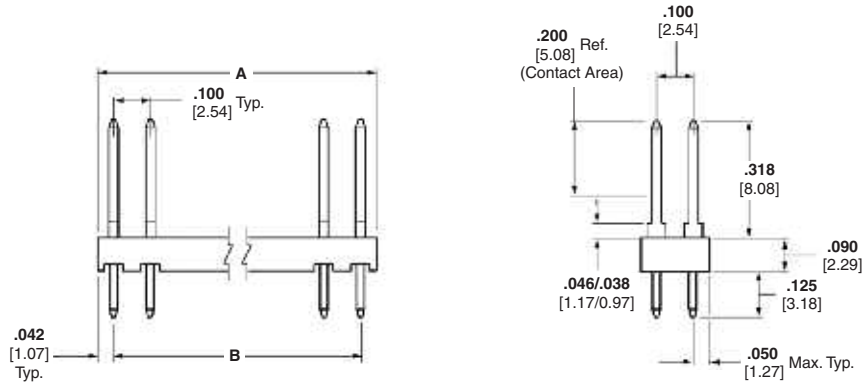

#### Material and Finish

**Housing** — Black thermoplastic, 94V-0 rated

**Posts** — Copper alloy, plated as follows:

**Plating A** — Selectively plated .000030 [0.00076] gold on contact area, with gold flash over .000050 [0.00127] nickel on entire post

**Plating B** — Selectively plated .000015 [0.00038] gold on contact area, with gold flash over .000050 [0.00127] nickel on entire post

**Tin/Nickel** — Plating option available; minimum order quantities may apply. Consult TE.

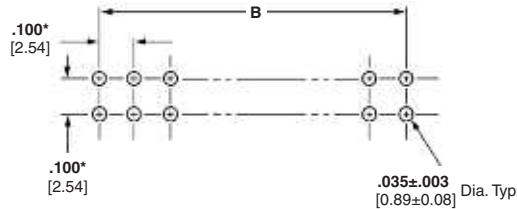

#### Recommended PC Board Hole Layout (for .055 [1.40] min. thick PC board)

\*±.003 [±0.08] tolerances not to accumulate within one connector pattern.

#### Related Product Data

**Mateable Connectors** — Refer to the Mating Post Selection Guide — page 90

#### Accessories

**Barrier Insert** — page 204

#### Technical Documents — page 276

See mating connector for applicable product and application specifications.

No. of Pos.	Dimensions		Post Plating/Part Nos.	
	A	B	Plating A	Plating B
2	.084 [2.13]	—	1-87215-0	87227-1
4	.184 [4.67]	.100 [2.54]	1-87215-1	87227-2
6	.284 [7.21]	.200 [5.08]	1-87215-2	87227-3
8	.384 [9.75]	.300 [7.62]	87215-1	87227-4
10	.484 [12.29]	.400 [10.16]	87215-2	87227-5
12	.584 [14.83]	.500 [12.70]	87215-3	87227-6
14	.684 [17.37]	.600 [15.24]	87215-4	87227-7
16	.784 [19.91]	.700 [17.78]	87215-5	87227-8
18	.884 [22.45]	.800 [20.32]	87215-6	87227-9
20	.984 [24.99]	.900 [22.86]	87215-7	1-87227-0
22	1.084 [27.53]	1.000 [25.40]	1-87215-3	1-87227-1
24	1.184 [30.07]	1.100 [27.94]	87215-8	1-87227-2
26	1.284 [32.61]	1.200 [30.48]	87215-9	1-87227-3
28	1.384 [35.15]	1.300 [33.02]	1-87215-4	1-87227-4
30	1.484 [37.69]	1.400 [35.56]	1-87215-5	1-87227-5
32	1.584 [40.23]	1.500 [38.10]	1-87215-6	1-87227-6
34	1.684 [42.77]	1.600 [40.64]	1-87215-7	1-87227-7
36	1.784 [45.31]	1.700 [43.18]	1-87215-8	1-87227-8
38	1.884 [47.85]	1.800 [45.72]	1-87215-9	1-87227-9
40	1.984 [50.39]	1.900 [48.26]	2-87215-0	2-87227-0

**Note:** All part numbers are RoHS compliant.



**Standard Headers—Unshrouded, Double-Row,  
.100 x .100 [2.54 x 2.54] Centerline** (Continued)

No. of Pos.	Dimensions		Post Plating/Part Nos.	
	A	B	Plating A	Plating B
42	2.084 [52.93]	2.000 [50.80]	2-87215-1	2-87227-1
44	2.184 [55.47]	2.100 [53.34]	2-87215-2	2-87227-2
46	2.284 [58.01]	2.200 [55.88]	2-87215-3	2-87227-3
48	2.384 [60.55]	2.300 [58.42]	2-87215-4	2-87227-4
50	2.484 [63.09]	2.400 [60.96]	2-87215-5	2-87227-5
52	2.584 [65.63]	2.500 [63.50]	2-87215-6	2-87227-6
54	2.684 [68.17]	2.600 [66.04]	2-87215-7	2-87227-7
56	2.784 [70.71]	2.700 [68.58]	2-87215-8	2-87227-8
58	2.884 [73.25]	2.800 [71.12]	2-87215-9	2-87227-9
60	2.984 [75.79]	2.900 [73.66]	3-87215-0	3-87227-0
62	3.084 [78.33]	3.000 [76.20]	3-87215-1	3-87227-1
64	3.184 [80.87]	3.100 [78.74]	3-87215-2	3-87227-2
66	3.284 [83.41]	3.200 [81.28]	3-87215-3	3-87227-3
68	3.384 [85.95]	3.300 [83.82]	3-87215-4	3-87227-4
70	3.484 [88.49]	3.400 [86.36]	3-87215-5	3-87227-5
72	3.584 [91.03]	3.500 [88.90]	3-87215-6	3-87227-6
74	3.684 [93.57]	3.600 [91.44]	3-87215-7	3-87227-7
76	3.784 [96.11]	3.700 [93.98]	3-87215-8	3-87227-8
78	3.884 [98.65]	3.800 [96.52]	3-87215-9	3-87227-9
80	3.984 [101.19]	3.900 [99.06]	4-87215-0	4-87227-0

**Note:** All part numbers are RoHS compliant.

## Standard Headers—Unshrouded, Double-Row, .100 x .100 [2.54 x 2.54] Centerline (Continued)

### .025 [0.64] Square Right-Angle Post



#### Material and Finish

**Housing** — Black thermoplastic, 94V-0 rated

**Posts** — Copper alloy, plated as follows:

**Plating A** — Selectively plated .000030 [0.00076] gold on contact area, with gold flash over .000050 [0.00127] nickel on entire post

**Plating B** — Selectively plated .000015 [0.00038] gold on contact area, with gold flash over .000050 [0.00127] nickel on entire post

**Tin/Nickel** — Plating option available; minimum order quantities may apply. Consult TE.

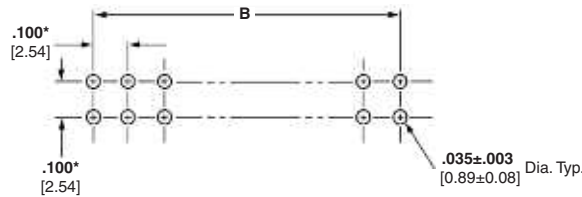
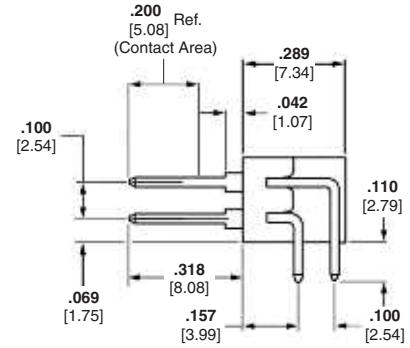
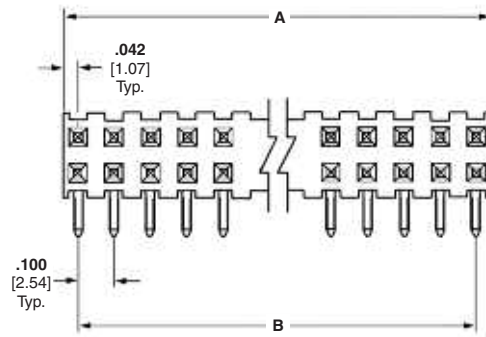

**Recommended PC Board Hole Layout (for .055 [1.40] min. thick PC board)**

\*±.003 [±0.08] tolerances not to accumulate within one connector pattern.

#### Related Product Data

**Mateable Connectors** — Refer to the Mating Post Selection Guide — page 90

#### Technical Documents — page 276

See mating connector for applicable product and application specifications.

No. of Pos.	Dimensions		Post Plating/Part Nos.	
	A	B	Plating A	Plating B
2	.084 [2.13]	—	1-86479-3	87230-1
4	.184 [4.67]	.100 [2.54]	1-86479-4	87230-2
6	.284 [7.21]	.200 [5.08]	1-86479-5	87230-3
8	.384 [9.75]	.300 [7.62]	1-86479-6	87230-4
10	.484 [12.29]	.400 [10.16]	86479-3	87230-5
12	.584 [14.83]	.500 [12.70]	86479-4	87230-6
14	.684 [17.37]	.600 [15.24]	86479-5	87230-7
16	.784 [19.91]	.700 [17.78]	86479-2	87230-8
18	.884 [22.45]	.800 [20.32]	86479-6	87230-9
20	.984 [24.99]	.900 [22.86]	86479-1	1-87230-0
22	1.084 [27.53]	1.000 [25.40]	1-86479-7	1-87230-1
24	1.184 [30.07]	1.100 [27.94]	86479-7	1-87230-2
26	1.284 [32.61]	1.200 [30.48]	1-86479-0	1-87230-3
28	1.384 [35.15]	1.300 [33.02]	1-86479-8	1-87230-4
30	1.484 [37.69]	1.400 [35.56]	1-86479-9	1-87230-5
32	1.584 [40.23]	1.500 [38.10]	2-86479-0	1-87230-6
34	1.684 [42.77]	1.600 [40.64]	2-86479-1	1-87230-7
36	1.784 [45.31]	1.700 [43.18]	2-86479-2	1-87230-8
38	1.884 [47.85]	1.800 [45.72]	2-86479-3	1-87230-9
40	1.984 [50.39]	1.900 [48.26]	2-86479-4	2-87230-0

**Note:** All part numbers are RoHS compliant.

**Standard Headers—Unshrouded, Double-Row,  
.100 x .100 [2.54 x 2.54] Centerline** (Continued)

No. of Pos.	Dimensions		Post Plating/Part Nos.	
	A	B	Plating A	Plating B
42	2.084 [52.93]	2.000 [50.80]	2-86479-5	2-87230-1
44	2.184 [55.47]	2.100 [53.34]	2-86479-6	2-87230-2
46	2.284 [58.01]	2.200 [55.88]	2-86479-7	2-87230-3
48	2.384 [60.55]	2.300 [58.42]	2-86479-8	2-87230-4
50	2.484 [63.09]	2.400 [60.96]	2-86479-9	2-87230-5
52	2.584 [65.63]	2.500 [63.50]	3-86479-0	2-87230-6
54	2.684 [68.17]	2.600 [66.04]	3-86479-1	2-87230-7
56	2.784 [70.71]	2.700 [68.58]	3-86479-2	2-87230-8
58	2.884 [73.25]	2.800 [71.12]	3-86479-3	2-87230-9
60	2.984 [75.79]	2.900 [73.66]	3-86479-4	3-87230-0
62	3.084 [78.33]	3.000 [76.20]	3-86479-5	3-87230-1
64	3.184 [80.87]	3.100 [78.74]	3-86479-6	3-87230-2
66	3.284 [83.41]	3.200 [81.28]	3-86479-7	3-87230-3
68	3.384 [85.95]	3.300 [83.82]	3-86479-8	3-87230-4
70	3.484 [88.49]	3.400 [86.36]	3-86479-9	3-87230-5
72	3.584 [91.03]	3.500 [88.90]	4-86479-0	3-87230-6
74	3.684 [93.57]	3.600 [91.44]	4-86479-1	3-87230-7
76	3.784 [96.11]	3.700 [93.98]	4-86479-2	3-87230-8
78	3.884 [98.65]	3.800 [96.52]	4-86479-3	3-87230-9
80	3.984 [101.19]	3.900 [99.06]	4-86479-4	4-87230-0

**Note:** All part numbers are RoHS compliant.

**Standard Headers—Unshrouded, Triple-Row, .100 [2.54] Centerline**

**.025 [0.64] Square Straight Post**

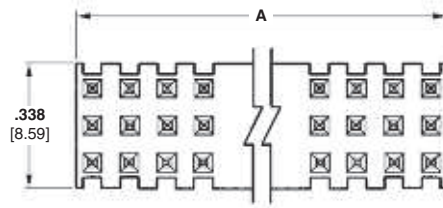

**Material and Finish**

**Housing** — Black thermoplastic, 94V-0 rated

**Posts** — Phosphor bronze, duplex plated 000030 [0.00076] gold on contact area, .000100-.000200 [0.00254-0.00508] tin on solder area, with entire post underplated .000050 [0.00127] nickel

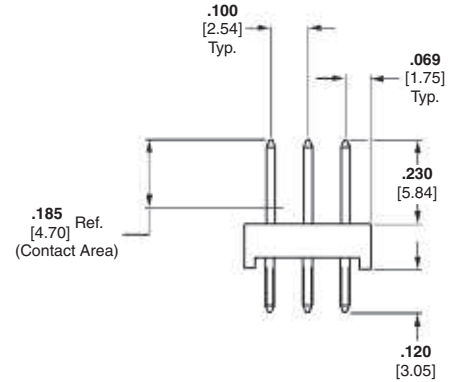
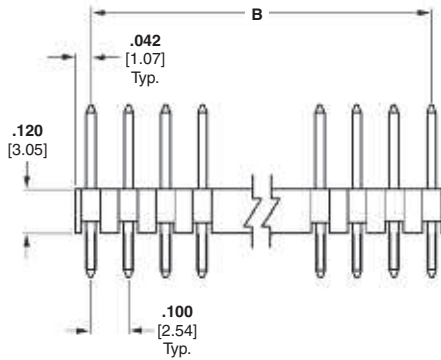

**Technical Documents** — page 276

See mating connector for applicable product and application specifications.

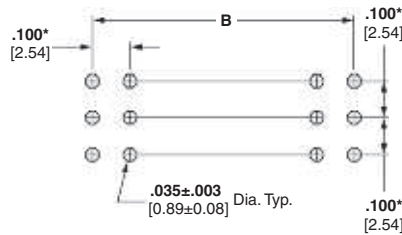

**Recommended PC Board Hole Layout (for .055 [1.40] min. thick PC board)**

\*±.003 [±0.08] tolerances not to accumulate within one connector pattern.

Unshrouded Headers



5

No. of Pos.	Dimensions		Part Nos.
	A	B	
9	.284 [7.21]	.200 [5.08]	5-103817-1
12	.384 [9.75]	.300 [7.62]	5-103817-2
15	.484 [12.29]	.400 [10.16]	5-103817-3
18	.584 [14.83]	.500 [12.70]	5-103817-4
21	.684 [17.37]	.600 [15.24]	5-103817-5
24	.784 [19.91]	.700 [17.78]	5-103817-6
27	.884 [22.45]	.800 [20.32]	5-103817-7
30	.984 [24.99]	.900 [22.86]	5-103817-8
33	1.084 [27.53]	1.000 [25.40]	5-103817-9
42	1.384 [35.15]	1.300 [33.02]	6-103817-2
45	1.484 [37.69]	1.400 [35.56]	6-103817-3
60	1.984 [50.39]	1.900 [48.26]	6-103817-8
69	2.284 [58.01]	2.200 [55.88]	7-103817-1
72	2.384 [60.55]	2.300 [58.42]	7-103817-2
96	3.184 [80.87]	3.100 [78.74]	8-103817-0
120	3.984 [101.19]	3.900 [99.06]	8-103817-8

**Note:** All part numbers are RoHS compliant.

## Breakaway and Retention Headers—Unshrouded

### Product Facts

- Design and inventory versatility—headers can be broken into any size needed
- Variety of popular sizes available
- Substantial time/labor savings can install all posts at one time
- Vertical and right-angle versions available in single- and double-row configurations
- Phosphor bronze posts
- Choice of gold duplex or tin plated posts
- Post lengths include .230 [5.84] and .318 [8.08] for connector mating
- Board retention feature available
- Black, glass-filled thermoplastic housings; high temperature compatible
- Recognized under the Component Program of Underwriters Laboratories Inc., File No. E28476 
- Certified by Canadian Standards Association, File No. LR 7189 



### Performance Characteristics

#### Electrical

**Insulation Resistance** — 5,000 megohms minimum initial

**Dielectric Withstanding Voltage** — 750 V rms at sea level

#### Environmental

**Operating Temperature** — -65°C to +105°C (black thermoplastic housings)

**Current** — 3 amperes maximum per contact (dependent upon mating receptacle)

## Breakaway Headers—Unshrouded, Single-Row, .100 [2.54] Centerline

### .025 [0.64] Square Straight Posts



#### Material and Finish

**Housing** — Black thermoplastic, 94V-0 rated, high temperature compatible

**Posts** — Phosphor bronze, plated as follows:

**Plating A** — Duplex plated .000030 [0.00076] gold on contact area, .000100-.000200 [0.00254-0.00508] tin on solder tail, with entire post underplated .000050 [0.00127] nickel

**Plating B** — Duplex plated .000015 [0.00038] gold on contact area, .000100-.000200 [0.00254-0.00508] tin on solder tail, with entire post underplated .000050 [0.00127] nickel

**Plating C** — .000100-.000200 [0.00254-0.00508] tin over .000050 [0.00127] nickel

#### Performance Characteristics (Board Retention Tails)

**Insertion Force** — 12 lb [53.4N] max.

**Retention Force** — .25 lb [1.11N] min.

#### Related Product Data

**Mateable Connectors** — Refer to the Mating Post Selection Guide — page 90

#### Technical Documents — page 276

See mating connector for applicable product and application specifications.

### Headers with Solder Tails

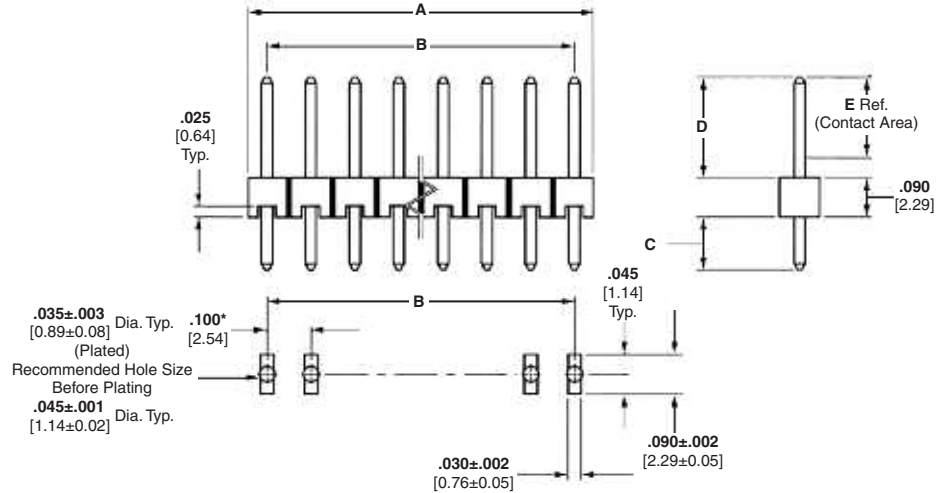

**Recommended PC Board Mounting Pattern (for .062 [1.57] thick PC board; .008 [2.03] thick stencil)**

\*±.003 [±0.08] tolerances not to accumulate within one connector pattern.

### Headers with Board Retention Tails

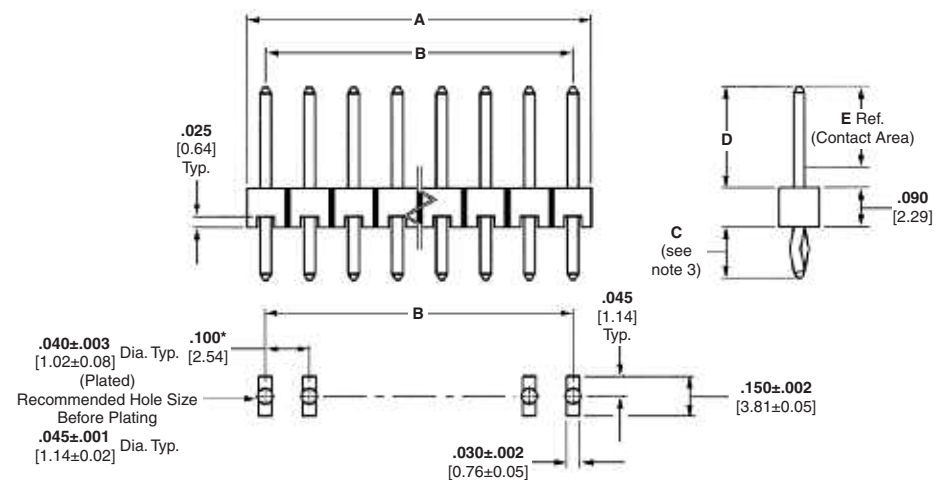

**Recommended PC Board Mounting Pattern (for .062 [1.57] thick PC board; .008 [2.03] thick stencil)**

\*±.003 [±0.08] tolerances not to accumulate within one connector pattern.

Header Style	No. of Pos.	Dimensions		C = .090 [2.29] D = .230 [5.84] E = .185 [4.70]			C = .120 [3.05] D = .230 [5.84] E = .185 [4.70]			C = .125 [3.18] D = .318 [8.08] E = .200 [5.08]		
		A	B	Post Plating/Part Nos.			Post Plating/Part Nos.			Post Plating/Part Nos.		
				Plating A	Plating B	Plating C	Plating A	Plating B	Plating C	Plating A	Plating B	Plating C
With Solder Tails (See Notes 1 and 2.)	1	.084 [2.13]	—	5-146285-1	5-146284-1	5-146282-1	5-146281-1	5-146280-1	5-146278-1	5-146277-1	5-146276-1	5-146274-1
	40	3.984 [101.19]	3.900 [99.06]	9-146285-0	9-146284-0	9-146282-0	9-146281-0	9-146280-0	9-146278-0	9-146277-0	9-146276-0	9-146274-0
With Board Retention Tails (See Notes 2 and 3.)	3	.284 [7.21]	.200 [5.08]	5-146297-3	5-146296-3	5-146294-3	5-146293-3	5-146292-3	5-146290-3	5-146289-3	5-146288-3	5-146286-3
	40	3.984 [101.19]	3.900 [99.06]	9-146297-0	9-146296-0	9-146294-0	9-146293-0	9-146292-0	9-146290-0	9-146289-0	9-146288-0	9-146286-0

- Notes:**
- Headers without retention tails may be broken to the desired number of positions using **Tool Kit No. 314818-1 (not shown)**.
  - Headers are also available in sizes 2 thru 39 positions (with Solder Tails) and 4 thru 39 positions (with Board Retention Tails). When ordering, add the prefix and/or suffix (dash) numbers plus 5- -0 to the base part number that corresponds with the desired size. For example, the complete part number for an 8-position header with solder tails (C dimension .090 [2.29], post plating A) would be 5-146285-8. The complete part number for a 26-position header with board retention tails (C dimension .120 [3.05], post plating B) would be 7-146292-6. This part numbering system applies only to this page.
  - For C dimensions .120 [3.05] and .125 [3.18], board retention using kinked tails are for headers 6 positions and smaller; headers 7 positions and larger use swaged tails. Headers with a C dimension of .090 [2.29] have swaged tails for all sizes.

**Note:** All part numbers are RoHS compliant.

## Breakaway Headers—Unshrouded, Single-Row, .100 [2.54] Centerline (Continued)

### .025 [0.64] Square Right-Angle Posts



#### Material and Finish

**Housing** — Black thermoplastic, 94V-0 rated, high temperature compatible

**Posts** — Phosphor bronze, duplex plated .000030 [0.00076] gold on contact area, .000100-.000200 [0.00254-0.00508] matte tin on solder tail, with entire post underplated .000050 [0.00127] nickel

#### Performance Characteristics (Board Retention Tails)

**Insertion Force** — 12 lb [53.4N] max.

**Retention Force** — .25 lb [1.11N] min.

#### Related Product Data

**Mateable Connectors** — Refer to the Mating Post Selection Guide — page 90

#### Technical Documents — page 276

See mating connector for applicable product and application specifications.

### Headers with Solder Tails

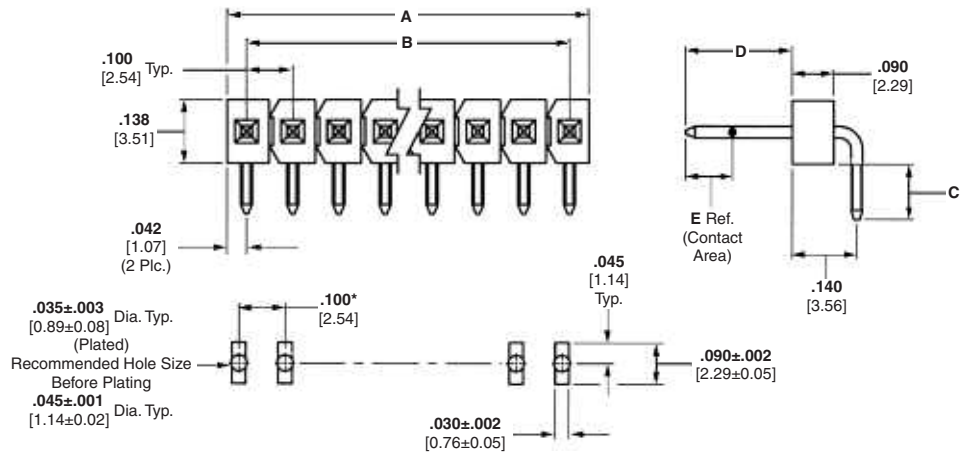

**Recommended PC Board Mounting Pattern**  
(for .062 [1.57] thick PC board; .008 [.203] thick stencil)  
\*±.003 [±0.08] tolerances not to accumulate within one connector pattern.

### Headers with Board Retention Tails

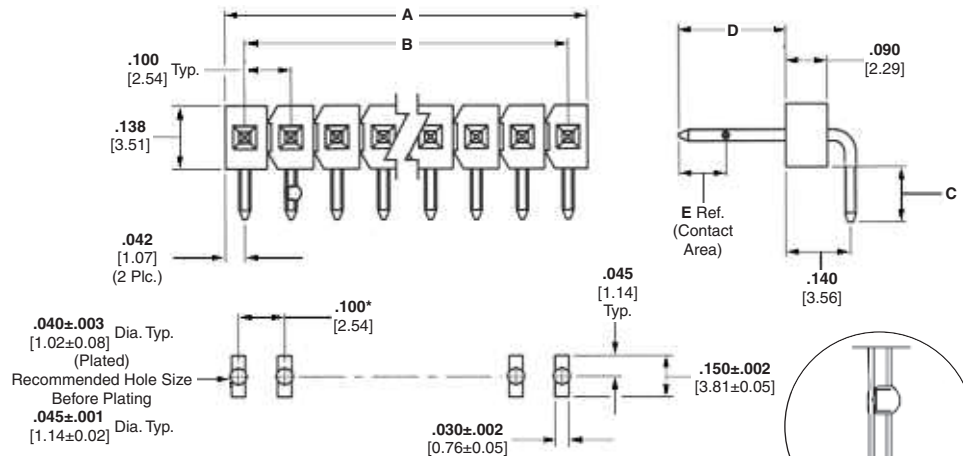

**Recommended PC Board Mounting Pattern**  
(for .062 [1.57] thick PC board; .008 [.203] thick stencil)  
\*±.003 [±0.08] tolerances not to accumulate within one connector pattern.

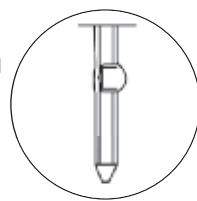

**Board Retention Tail using Swaged Tails (All Header Sizes)**

Header Style	No. of Pos.	Dimensions		Part Nos.	
		A	B	C = .120 [3.05] D = .230 [5.84] E = .185 [4.70]	C = .110 [2.79] D = .318 [8.08] E = .200 [5.08]
With Solder Tails (See Notes 1 and 2.)	1	.084 [2.13]	—	5-146304-1	5-146305-1
	40	3.984 [101.19]	3.900 [99.06]	9-146304-0	9-146305-0
With Board Retention Tails (See Note 2.)	3	.084 [2.13]	—	5-146306-3	5-146307-3
	40	3.984 [101.19]	3.900 [99.06]	9-146306-0	9-146307-0

**Notes:** 1. Headers without retention tails may be broken to the desired number of positions using **Tool Kit No. 314818-1 (not shown)**.  
2. Headers are also available in sizes 2 thru 39 positions (with Solder Tails) and 4 thru 39 positions (with Board Retention Tails).  
When ordering, add the prefix and/or suffix (dash) numbers plus 5- -0 to the base part number that corresponds with the number of positions. For example, the complete part number for an 8-position header with solder tails (C dimension .120 [3.05]) would be 5-146304-8. The complete part number for a 26-position header with board retention tails (C dimension .120 [3.05]) would be 7-146306-6. This part numbering system applies only to this page.

**Note:** All part numbers are RoHS compliant.

## Breakaway Headers—Unshrouded, Double-Row, .100 x .100 [2.54 x 2.54] Centerline

### .025 [0.64] Square Straight Posts



#### Material and Finish

**Housing** — Black thermoplastic, 94V-0 rated, high temperature compatible

**Posts** — Phosphor bronze, plated as follows:

**Plating A** — Duplex plated .000030 [0.00076] gold on contact area, .000100-.000200 [0.00254-0.00508] tin on solder tail, with entire post underplated .000050 [0.00127] nickel

**Plating B** — Duplex plated .000015 [0.00038] gold on contact area, .000100-.000200 [0.00254-0.00508] tin on solder tail, with entire post underplated .000050 [0.00127] nickel

**Plating C** — .000100-.000200 [0.00254-0.00508] tin over .000050 [0.00127] nickel

#### Performance Characteristics (Board Retention Tails)

**Insertion Force** — 12 lb [53.4N] max.

**Retention Force** — .25 lb [1.11N] min.

#### Related Product Data

**Mateable Connectors** — Refer to the Mating Post Selection Guide — page 90

#### Technical Documents — page 276

See mating connector for applicable product and application specifications.

### Headers with Solder Tails

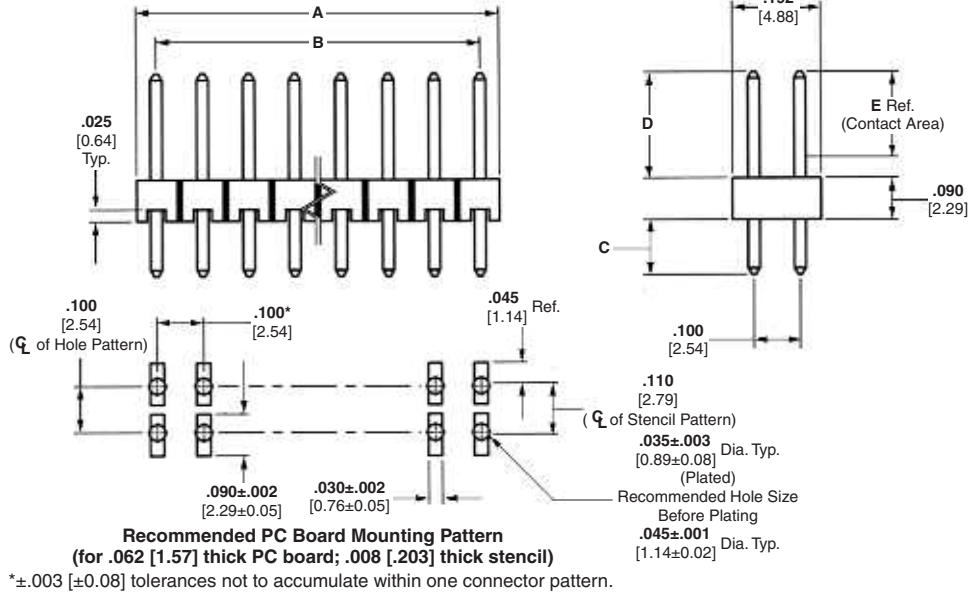

### Headers with Board Retention Tails

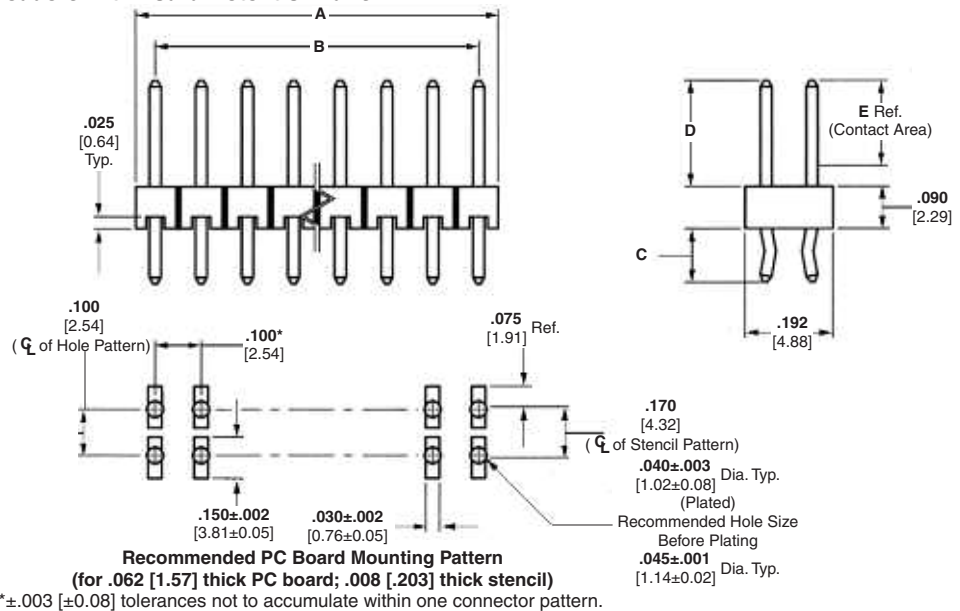

Header Style	No. of Pos.	Dimensions		C = .090 [2.29] D = .230 [5.84] E = .185 [4.70]			C = .120 [3.05] D = .230 [5.84] E = .185 [4.70]			C = .125 [3.18] D = .318 [8.08] E = .200 [5.08]		
		A	B	Post Plating/Part Nos.			Post Plating/Part Nos.			Post Plating/Part Nos.		
				Plating A	Plating B	Plating C	Plating A	Plating B	Plating C	Plating A	Plating B	Plating C
With Solder Tails (See Notes 1 and 2.)	2	.084 [2.13]	—	5-146261-1	5-146260-1	5-146258-1	5-146257-1	5-146256-1	5-146254-1	5-146253-1	5-146252-1	5-146250-1
	80	3.984 [101.19]	3.900 [99.06]	9-146261-0	9-146260-0	9-146258-0	9-146257-0	9-146256-0	9-146254-0	9-146253-0	9-146252-0	9-146250-0
With Board Retention Tails (See Note 2.)	2	.084 [2.13]	—	5-146273-1	5-146272-1	5-146270-1	5-146269-1	5-146268-1	5-146266-1	5-146265-1	5-146264-1	5-146262-1
	80	3.984 [101.19]	3.900 [99.06]	9-146273-0	9-146272-0	9-146270-0	9-146269-0	9-146268-0	9-146266-0	9-146265-0	9-146264-0	9-146262-0

**Notes:** 1. Headers without retention tails may be broken to the desired number of positions using **Tool Kit No. 314818-1** (not shown).  
2. Headers are also available in sizes 4 thru 78 positions. When ordering, add the prefix and/or suffix (dash) numbers plus 5-0 to the base part number that corresponds with the number of positions per row. For example, the complete part number for a 16-position header with solder tails (C dimension .090 [2.29], post plating A) would be 5-146261-8. The complete part number for a 40-position header with board retention tails (C dimension .120 [3.05], post plating B) would be 7-146268-0. This part numbering system applies only to this page.

**Note:** All part numbers are RoHS compliant.



## Breakaway Headers—Unshrouded, Double-Row, .100 x .100 [2.54 x 2.54] Centerline (Continued)

### .025 [0.64] Square Right-Angle Posts



#### Material and Finish

**Housing** — Black thermoplastic, 94V-0 rated, high temperature compatible

**Posts** — Phosphor bronze, duplex plated .000030 [0.00076] gold on contact area, .000100-.000200 [0.00254-0.00508] tin on solder tail, with entire post underplated .000050 [0.00127] nickel

#### Performance Characteristics (Board Retention Tails)

**Insertion Force** — 12 lb [53.4N] max.

**Retention Force** — .25 lb [1.11N] min.

#### Related Product Data

**Mateable Connectors** — Refer to the Mating Post Selection Guide — page 90

#### Technical Documents — page 276

See mating connector for applicable product and application specifications.

### Headers with Solder Tails

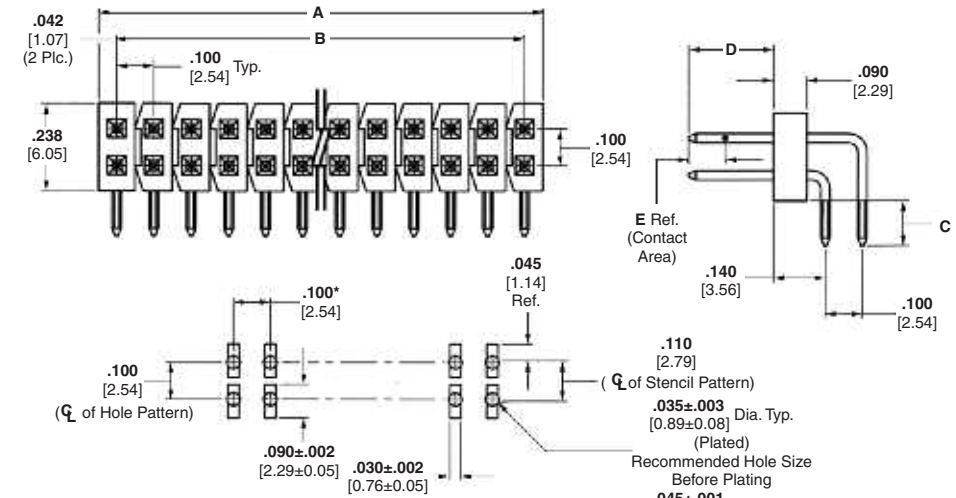

#### Recommended PC Board Mounting Pattern (for .062 [1.57] thick PC board; .008 [.203] thick stencil)

\*±.003 [±0.08] tolerances not to accumulate within one connector pattern.

### Headers with Board Retention Tails

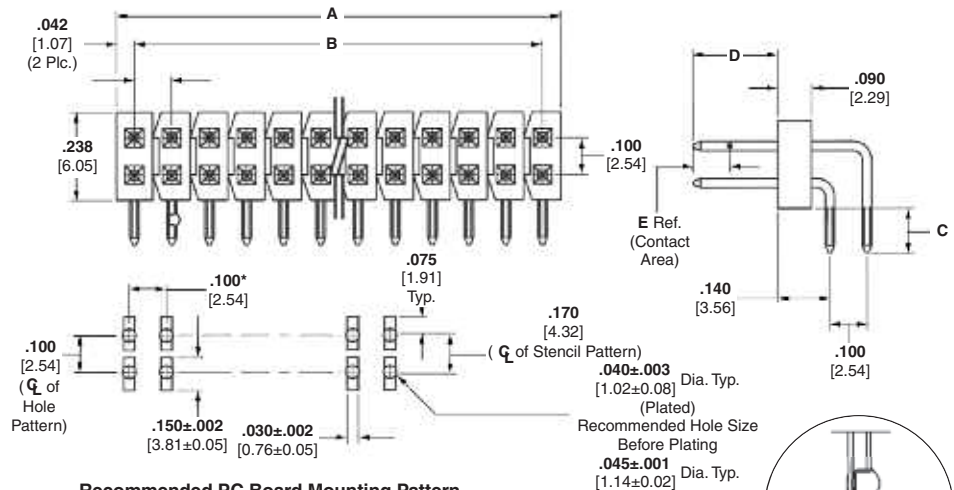

#### Recommended PC Board Mounting Pattern (for .062 [1.57] thick PC board; .008 [.203] thick stencil)

\*±.003 [±0.08] tolerances not to accumulate within one connector pattern.

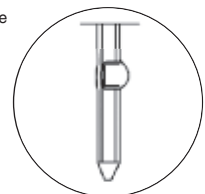

Board Retention using Swaged Tails (All Header Sizes)

Header Style	No. of Pos.	Dimensions		C = .120 [3.05] D = .230 [5.84] E = .185 [4.70] Part Nos.		C = .110 [2.79] D = .318 [8.08] E = .200 [5.08] Part Nos.	
		A	B				
With Solder Tails (See Notes 1 and 2.)	2	.084 [2.13]	—	5-146308-1	5-146309-1		
	80	3.984 [101.19]	3.900 [99.06]	9-146308-0	9-146309-0		
With Board Retention Tails (See Note 2.)	2	.084 [2.13]	—	5-146310-1	5-146311-1		
	80	3.984 [101.19]	3.900 [99.06]	9-146310-0	9-146311-0		

**Notes:** 1. Headers without retention tails may be broken to the desired number of positions using **Tool Kit No. 314818-1** (not shown).  
2. Headers are also available in sizes 4 thru 78 positions. When ordering, add the prefix and/or suffix (dash) numbers plus 5-0 to the base part number that corresponds with the number of positions per row. For example, the complete part number for a 16-position header with solder tails (C dimension .120 [3.05]) would be 5-146308-8. The complete part number for a 40-position header with board retention tails (C dimension .120 [3.05]) would be 7-146310-0. This part numbering system applies only to this page.

**Note:** All part numbers are RoHS compliant.

## AMPMODU Reeled Breakaway Headers

### Features of Breakaway Headers

- Design and inventory versatility — headers can easily be made into a variety of sizes
- High Temperature Compatible
- Reduced part number base
- Reduced inventory burden

### Applications

- Desktops & workstations
- Set-top boxes
- Televisions
- Automotive instrument panels & radios
- Medical and test equipment

### Benefits

- Off the shelf availability
- Various header length capability using the same reel
- Reduction of inventory costs
- Economy version of the standard breakaway headers

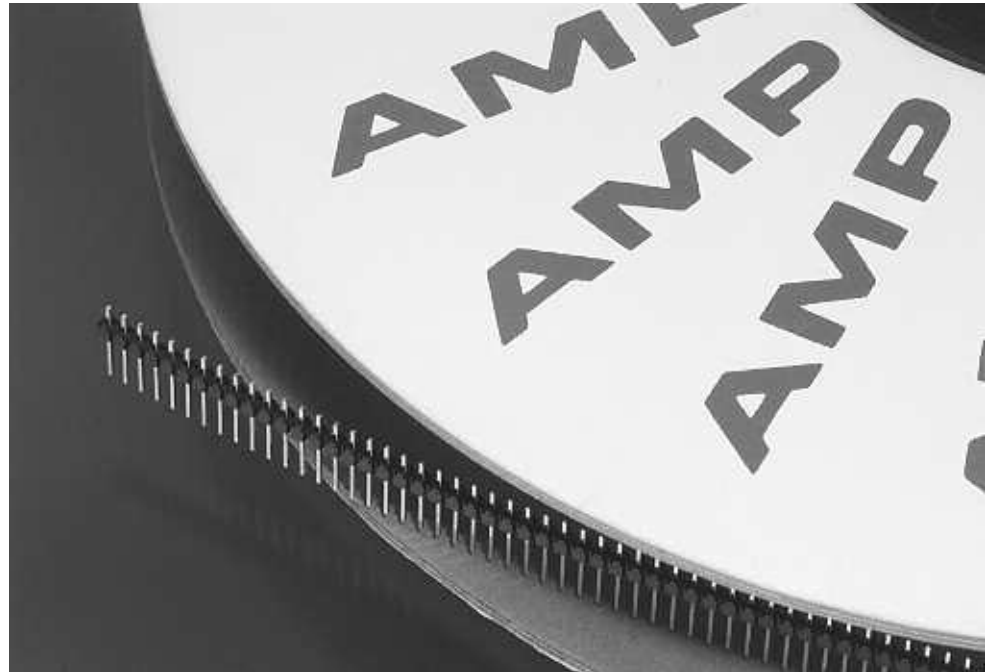

TE now offers AMPMODU reeled breakaway headers, which are used for board-to-board interconnections, on a continuous reel. The reeled breakaway headers are an economy version of the standard breakaway headers, and continue to provide the same high quality standards that TE is known for in the connector industry.

Reeled breakaway headers provide the flexibility to cut the headers to many different lengths, while only having to stock one part number. As a result, the amount of part numbers that need to be purchased and stored can be greatly reduced.

Reeled breakaway headers can be purchased in single and double rows with tin, 5 Au, 15 Au, and 30 Au duplex plating. The lower applied cost also offers .230" and .318" mating lengths. (See standard breakaway-to-reeled header conversion chart for vertical headers on the reverse side of this sheet)

Potential industries include: computer peripherals, telecommunications equipment, consumer, automotive, medical and test equipment.

Tooling available from:  
Robo-Pak, Inc.  
814 Lakeshore Drive  
East Bethel, MN 55902

A pin retention and pin removal tooling option is also available in addition to cutting.

### AMPMODU Reeled Breakaway Headers (Continued)

#### Single Row

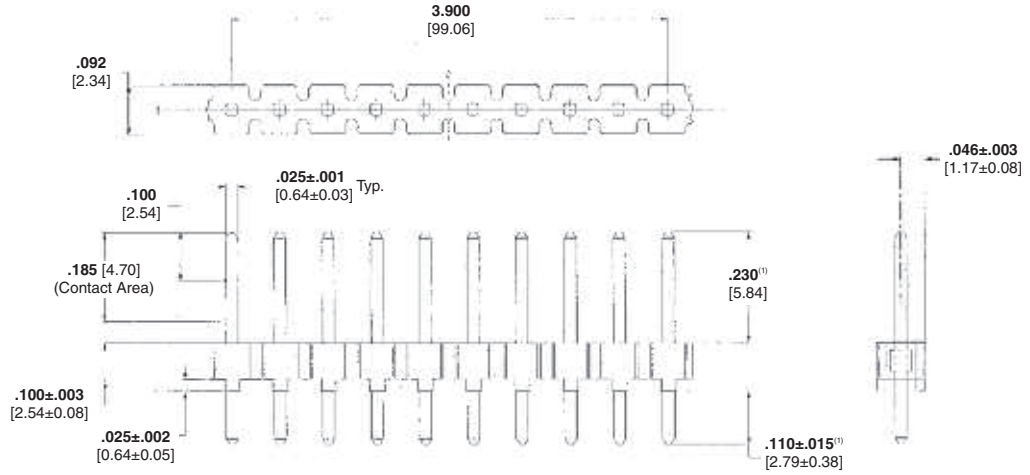

#### Double Row

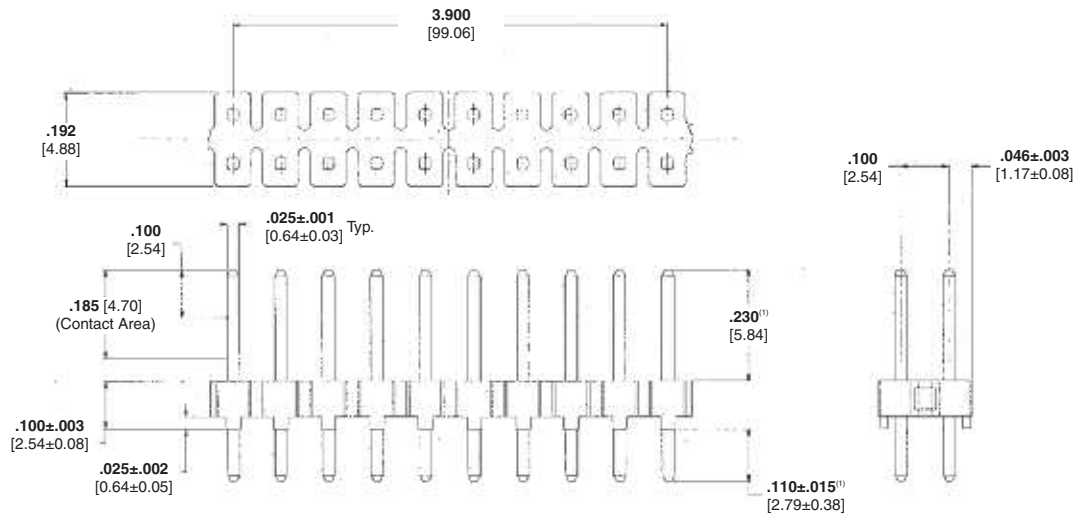

(1) See table for other mate and tail lengths.

Standard Breakaway-to-Reeled Header Conversion Chart (Vertical)								
Plating Options	Double Row Headers				Single Row Headers			
	Existing TE P/N	Make From Reeled P/N	Existing TE P/N	Make From Reeled P/N	Existing TE P/N	Make From Reeled P/N	Existing TE P/N	Make From Reeled P/N
	Mate: .318 Tail: .125	Mate: .318 Tail: .115	Mate: .230 Tail: .120	Mate: .230 Tail: .110	Mate: .318 Tail: .125	Mate: .318 Tail: .115	Mate: .230 Tail: .120	Mate: .230 Tail: .110
Tin	103322	5-146853-1	103328	5-146851-1	103321	5-146852-1	103327	5-146850-1
	146250		146254		146274		146278	
15 Au Duplex	102973	5-146861-1	103186	5-146859-1	102972	5-146860-1	103185	5-146858-1
	146252		146256		146276		146280	
30 Au Duplex	102977	5-146871-1	103240	5-146869-1	102976	5-146870-1	103239	5-146868-1
	146253		146257		146277		146281	

**Note:** Reeled Headers are a functional substitute for standard breakaways, however there are visual differences (i.e. housing appearance and bow due to reeling requirement).

**Note:** All part numbers are RoHS compliant.

**Breakaway Surface Mount Headers, .100 x .100 [2.54 x 2.54] Centerline**

**Product Facts**

- Surface Mount Leads
- Contact Material: phosphor bronze
- High temperature, black thermoplastic housings, 94V-0 rated, capable of withstanding IR or vapor-phase reflow
- Recognized under the Component Program of Underwriters Laboratories Inc.  File No. E28476
- Certified by Canadian Standards Association,  File No. LR 7189
- Choice of gold duplex or tin plated posts
- Posts coplanar within .006 [0.15]
- Tape and reel packaging available in addition to single tube packaging. Contact TE.
- Pick-and-place cap available for vacuum placement. Contact TE.

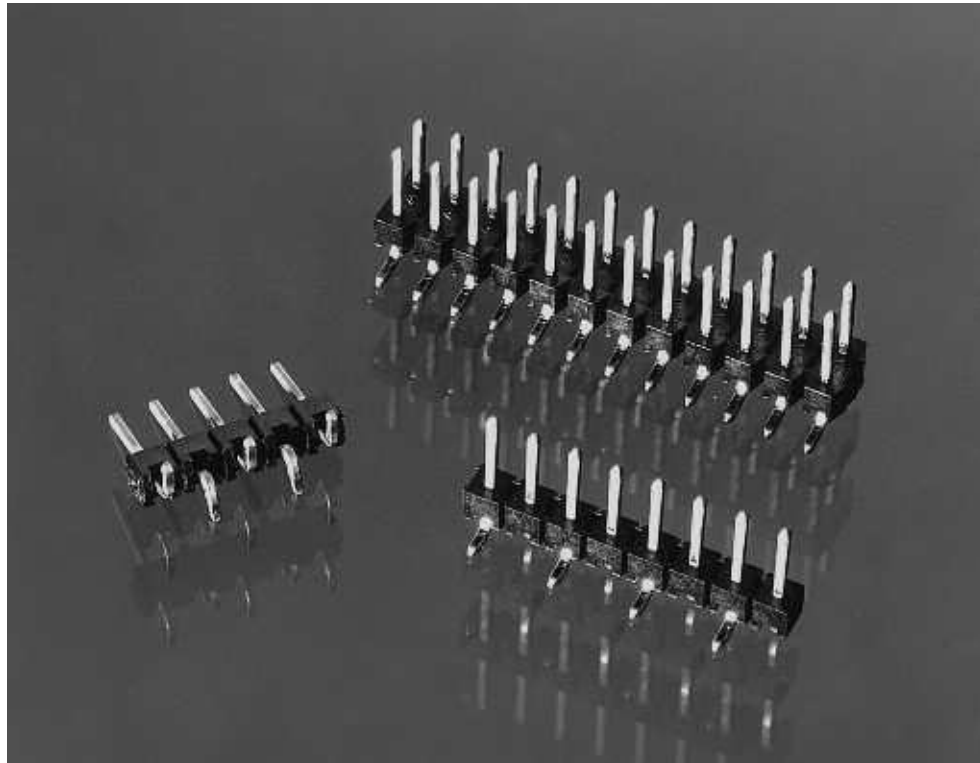

An extension of the AMPMODU Breakaway Header product family are the surface mount, vertical breakaway headers. The AMPMODU Surface Mount breakaway headers (Unshrouded) are available

in single- and double-row vertical configurations with mating lengths of .230 [5.84] and .320 [8.13]. Posts are offered with a choice of either .000030 [.0007] gold duplex or tin plating.

Current packaging is in a single tube but tape and reel is available for automatic pick-and-place. We also can provide a pick-and-place cap for vacuum placement if required.

Surface Mount Breakaway Headers

5

## Breakaway Surface Mount Headers—Unshrouded Single-Row, .100 [2.54] Centerline

### .025 [0.64] Square Straight Post



#### Material and Finish

**Housing** — Black thermoplastic, 94V-0 rated

**Posts** — Phosphor bronze, plated as follows:

**Plating A** — Duplex plated .000030 [0.00076] gold on contact area, .000100-.000200 [0.00254-0.00508] tin on solder area, with entire post underplated .000050 [0.00127] nickel

**Plating B** — .000100-.000200 [0.00254-0.00508] tin over .000050 [0.00127] nickel entire post

#### Related Product Data

**Mateable Receptacle** — Refer to Mating Post Selection Guide — page 90

#### Technical Documents — page 276

See mating connector for applicable product and application specifications.

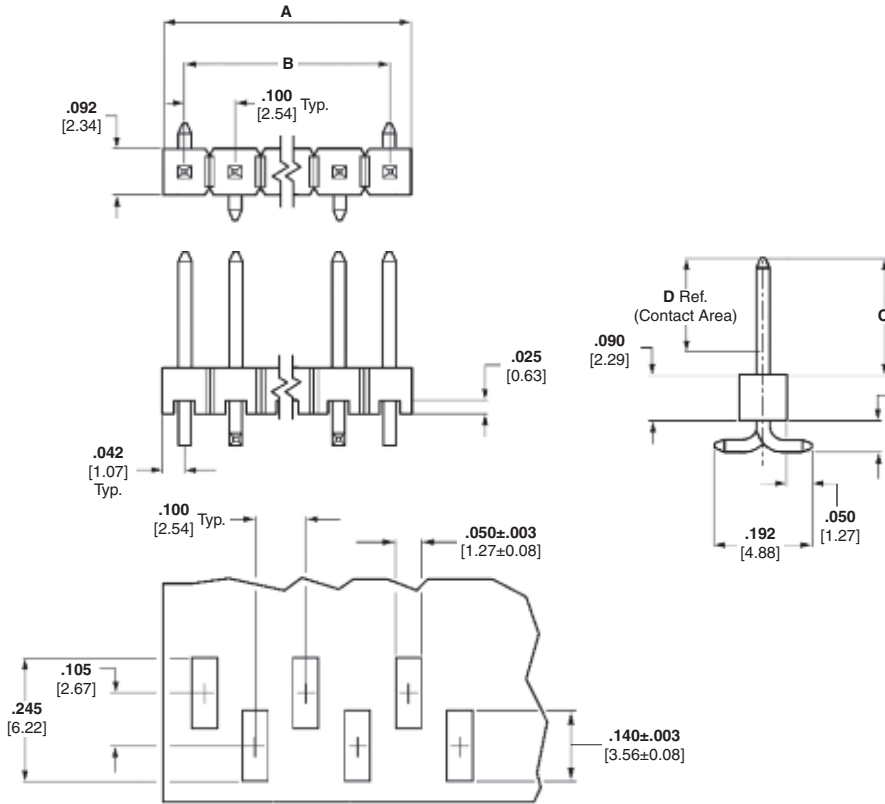

Recommended Etched Circuit Layout  
(Using .008 [0.20] thick stencil)

Surface Mount Breakaway Headers 5

No. of Pos.	Dimensions		C = .230 [5.84] D = .185 [4.70]		C = .320 [8.13] D = .200 [5.08]	
	A	B	Post Plating/Part Nos.		Post Plating/Part Nos.	
			Plating A	Plating B	Plating A	Plating B
3	.284 [7.21]	.200 [5.08]	5-146128-1	5-146132-1	5-146129-1	5-146133-1
4	.384 [9.75]	.300 [7.62]	5-146128-2	5-146132-2	5-146129-2	5-146133-2
5	.484 [12.29]	.400 [10.16]	5-146128-3	5-146132-3	5-146129-3	5-146133-3
6	.584 [14.83]	.500 [12.70]	5-146128-4	5-146132-4	5-146129-4	5-146133-4
7	.684 [17.37]	.600 [15.24]	5-146128-5	5-146132-5	5-146129-5	5-146133-5
8	.784 [19.91]	.700 [17.78]	5-146128-6	5-146132-6	5-146129-6	5-146133-6
9	.884 [22.45]	.800 [20.32]	5-146128-7	5-146132-7	5-146129-7	5-146133-7
10	.984 [24.99]	.900 [22.86]	5-146128-8	5-146132-8	5-146129-8	5-146133-8
11	1.084 [27.53]	1.000 [25.40]	5-146128-9	5-146132-9	5-146129-9	5-146133-9
12	1.184 [30.07]	1.100 [27.94]	6-146128-0	6-146132-0	6-146129-0	6-146133-0
13	1.284 [32.61]	1.200 [30.48]	6-146128-1	6-146132-1	6-146129-1	6-146133-1
14	1.384 [35.15]	1.300 [33.02]	6-146128-2	6-146132-2	6-146129-2	6-146133-2
15	1.484 [37.69]	1.400 [35.56]	6-146128-3	6-146132-3	6-146129-3	6-146133-3

**Note:** All part numbers are RoHS compliant.

## Breakaway Surface Mount Headers—Unshrouded Double-Row, .100 x .100 [2.54 x 2.54] Centerline

### .025 [0.64] Square Straight Post



#### Material and Finish

**Housing** — Black thermoplastic, 94V-0 rated

**Posts** — Phosphor bronze, plated as follows:

**Plating A** — Duplex plated .000030 [0.00076] gold on contact area, .000100-.000200 [0.00254-0.00508] tin on solder area, with entire post underplated .000050 [0.00127] nickel

**Plating B** — .000100-.000200 [0.00254-0.00508] tin over .000050 [0.00127] nickel entire post

#### Related Product Data

**Mateable Receptacles** — Refer to Mating Post Selection Guide — page 90

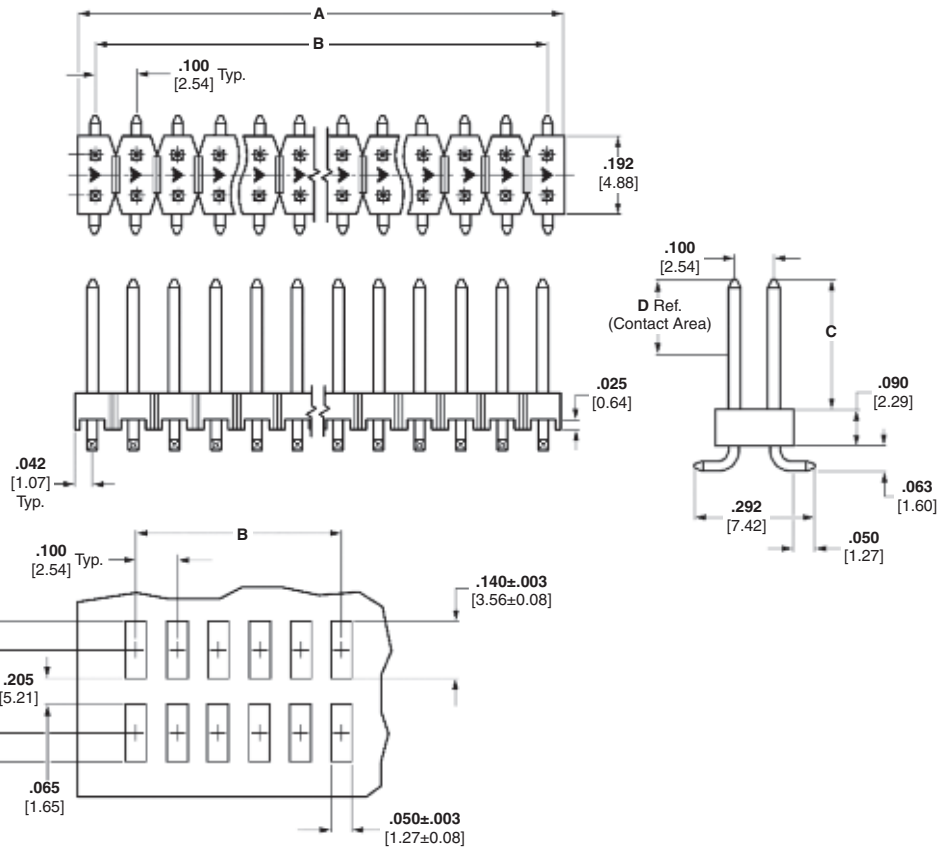

Recommended Etched Circuit Layout (Using .008 [0.20] thick stencil)

No. of Pos.	Dimensions		C = .230 [5.84] D = .185 [4.70]		C = .320 [8.13] D = .200 [5.08]	
	A	B	Post Plating/Part Nos.		Post Plating/Part Nos.	
			Plating A	Plating B	Plating A	Plating B
4	.184 [4.67]	.100 [2.54]	5-146130-1	5-146134-1	5-146131-1	5-146135-1
6	.284 [7.21]	.200 [5.08]	5-146130-2	5-146134-2	5-146131-2	5-146135-6
8	.384 [9.75]	.300 [7.62]	5-146130-3	5-146134-3	5-146131-3	5-146135-3
10	.484 [12.29]	.400 [10.16]	5-146130-4	1-146134-7	5-146131-4	5-146135-4
12	.584 [14.83]	.500 [12.70]	5-146130-5	5-146134-5	5-146131-5	5-146135-5
14	.684 [17.37]	.600 [15.24]	5-146130-6	5-146134-6	5-146131-6	5-146135-6
16	.784 [19.91]	.700 [17.78]	5-146130-7	1-146134-9	5-146131-7	5-146135-7
18	.884 [22.45]	.800 [20.32]	5-146130-8	5-146134-8	5-146131-8	5-146135-8
20	.984 [24.99]	.900 [22.86]	5-146130-9	5-146134-9	5-146131-9	5-146135-9
22	1.084 [27.53]	1.000 [25.40]	6-146130-0	6-146134-0	6-146131-0	6-146135-0
24	1.184 [30.07]	1.100 [27.94]	6-146130-1	6-146134-1	6-146131-1	6-146135-1
26	1.284 [32.61]	1.200 [30.48]	6-146130-2	6-146134-2	6-146131-2	6-146135-2
28	1.384 [35.15]	1.300 [33.02]	6-146130-3	6-146134-3	6-146131-3	6-146135-3
30	1.484 [37.69]	1.400 [35.56]	6-146130-4	2-146134-1	6-146131-4	6-146135-4

Note: All part numbers are RoHS compliant.

## Unshrouded Stacking Headers—Breakaway .100 x .100 [2.54 x 2.54] Centerline

### Product Facts

- Available in single and double row
- Parallel PC board stacking with numerous stack heights available
- Drawn wire posts allow 4 side mateability
- May eliminate the need for additional board spacers
- Can be used in conjunction with bottom entry receptacles
- Gold or tin plated
- Up to 1.430 [36.32] overall post length
- Retention and surface mount features available upon request
- Other header sizes can be made upon request
- Tape and reel packaging available. Contact TE.
- Pick-and-place cap available for vacuum placement. Contact TE.

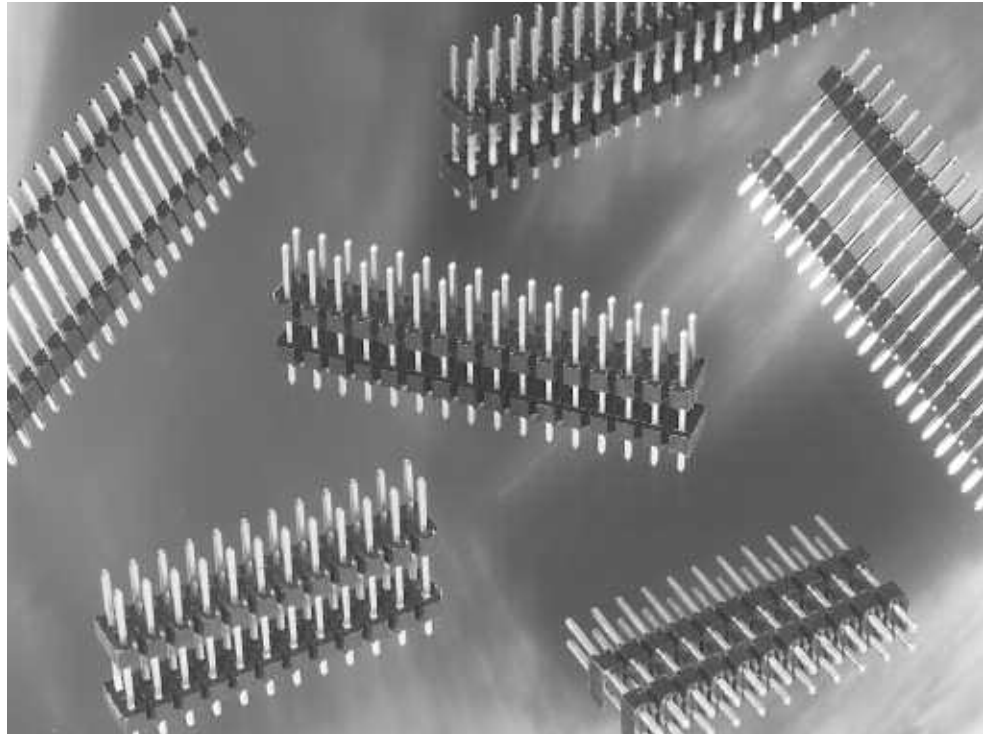

## Unshrouded Stacking Headers — Breakaway, Single-Row, .100 [2.54] Centerline

### .025 [0.64] Square Straight Posts

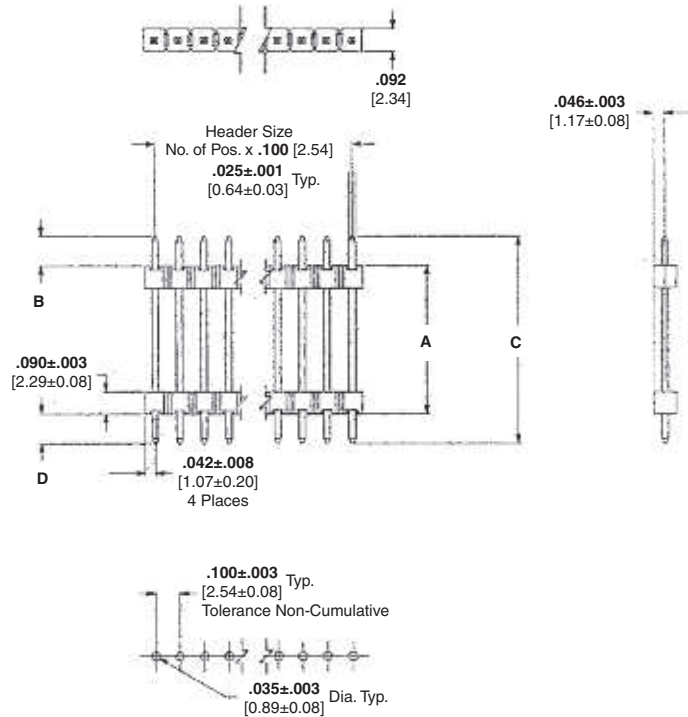

Recommended PC Board Hole Layout

### Material and Finish

**Housing** — Black thermoplastic, 94V-0 rated

**Posts** — Phosphor bronze, plated as follows:

**Plating** — As noted in chart:

**Tin** — .000100-.000200 [0.00254-0.00508] tin over .000050 [0.00127] nickel entire post

**15Au** — .000015 [0.00038] gold over .000050 [0.00127] nickel entire post

### Related Product Data

**Mateable Receptacles** — Refer to the Mating Post Selection Guide — page 88

### Technical Documents — page 276

See mating connector for applicable product and application specifications.

**Retention and surface mount features available upon request. Other header sizes can be made upon request.**

**\*Note:** Headers are available in sizes 1 thru 40. When ordering, add the prefix and/or suffix (dash) numbers plus 5- 0 to the base part number that corresponds with the number of positions per row. For example, the complete part number for an 8-position header is 5-146455-8. The complete part number for a 16-position of the same series would be 6-146455-6.

Base Number (see note)	A Stack Height	B Tail Length	C Post Length	D Mating Length	B End Plating	D End Plating
146455	.200 [5.08]	.130 [3.30]	.440 [11.17]	.110 [2.79]	TIN	TIN
146456	.250 [6.35]	.080 [2.03]	.440 [11.17]	.110 [2.79]	TIN	TIN
146457	.250 [6.35]	.114 [2.89]	.474 [12.03]	.110 [2.79]	TIN	TIN
146458	.300 [7.62]	.123 [3.12]	.533 [13.53]	.110 [2.79]	TIN	TIN
146459	.400 [10.16]	.107 [2.71]	.617 [15.67]	.110 [2.79]	TIN	TIN
146460	.450 [11.43]	.057 [1.45]	.617 [15.67]	.110 [2.79]	TIN	TIN
146461	.500 [12.70]	.129 [3.27]	.739 [18.77]	.110 [2.79]	TIN	TIN
146462	.300 [7.62]	.109 [2.77]	.739 [18.77]	.330 [8.38]	TIN	15 AU
146463	.600 [15.24]	.107 [2.71]	.817 [20.75]	.110 [2.79]	TIN	TIN
146464	.400 [10.16]	.087 [2.20]	.817 [20.75]	.330 [8.38]	TIN	15 AU
146465	.700 [17.78]	.120 [3.05]	.930 [23.62]	.110 [2.79]	TIN	TIN
146466	.500 [12.70]	.100 [2.54]	.930 [23.62]	.330 [8.38]	TIN	15 AU
146467	.270 [6.86]	.330 [8.38]	.930 [23.62]	.330 [8.38]	15 AU	15 AU
146468	.800 [20.32]	.120 [3.05]	1.030 [26.16]	.110 [2.79]	TIN	TIN
146469	.600 [15.24]	.100 [2.54]	1.030 [26.16]	.330 [8.38]	TIN	15 AU
146470	.370 [9.39]	.330 [8.38]	1.030 [26.16]	.330 [8.38]	15 AU	15 AU
146471	.900 [22.86]	.120 [3.05]	1.130 [28.70]	.110 [2.79]	TIN	TIN
146472	.700 [17.78]	.100 [2.54]	1.130 [28.70]	.330 [8.38]	TIN	15 AU
146473	.470 [11.39]	.330 [8.38]	1.130 [28.70]	.330 [8.38]	15 AU	15 AU
146474	1.000 [25.40]	.120 [3.05]	1.230 [31.24]	.110 [2.79]	TIN	TIN
146475	.800 [20.32]	.100 [2.54]	1.230 [31.24]	.330 [8.38]	TIN	15 AU
146476	.570 [14.47]	.330 [8.38]	1.230 [31.24]	.330 [8.38]	15 AU	15 AU
146477	1.100 [27.94]	.120 [3.05]	1.330 [33.78]	.110 [2.79]	TIN	TIN
146478	.900 [22.68]	.100 [2.54]	1.330 [33.78]	.330 [8.38]	TIN	15 AU
146479	.670 [17.01]	.330 [8.38]	1.330 [33.78]	.330 [8.38]	15 AU	15 AU
146480	1.200 [30.48]	.120 [3.05]	1.430 [36.32]	.110 [2.79]	TIN	TIN
146481	1.000 [25.40]	.100 [2.54]	1.430 [36.32]	.330 [8.38]	TIN	15 AU
146482	.770 [19.55]	.330 [8.38]	1.430 [36.32]	.330 [8.38]	15 AU	15 AU

**Note:** All part numbers are RoHS compliant.



## Unshrouded Stacking Headers — Breakaway, Double-Row, .100 x .100 [2.54 x 2.54] Centerline

### .025 [0.64] Square Straight Posts

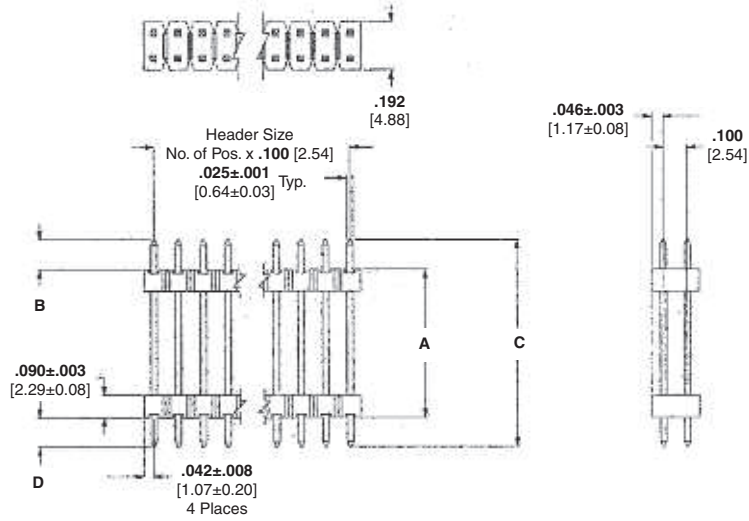

### Material and Finish

**Housing** — Black thermoplastic, 94V-0 rated

**Posts** — Phosphor bronze, plated as follows:

**Plating** — As noted in chart:

**Tin** — .000100-.000200 [0.00254-0.00508] tin over .000050 [0.00127] nickel entire post

**15Au** — .000015 [0.00038] gold over .000050 [0.00127] nickel entire post

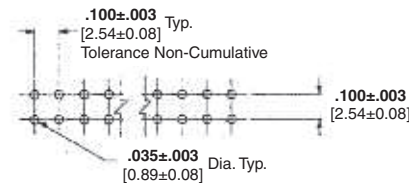

### Related Product Data

**Mateable Connectors** — Refer to the Mating Post Selection Guide — page 90

### Technical Documents — page 276

See mating connector for applicable product and application specifications.

**Retention and surface mount features available upon request. Other header sizes can be made upon request.**

**\*Note:** Headers are available in sizes 2 thru 80. When ordering, add the prefix and/or suffix (dash) numbers plus 5- -0 to the base part number that corresponds with the number of positions per row. For example, the complete part number for a 16-position header is 5-146283-8. The complete part number for a 32-position of the same series would be 6-146283-6.

Recommended PC Board Hole Layout

Base Number (see note)	A Stack Height	B Tail Length	C Post Length	D Mating Length	B End Plating	D End Plating
146483	.200 [5.08]	.130 [3.30]	.440 [11.17]	.110 [2.79]	TIN	TIN
146484	.250 [6.35]	.080 [2.03]	.440 [11.17]	.110 [2.79]	TIN	TIN
146485	.250 [6.35]	.114 [2.89]	.474 [12.03]	.110 [2.79]	TIN	TIN
146486	.300 [7.62]	.123 [3.12]	.533 [13.53]	.110 [2.79]	TIN	TIN
146487	.400 [10.16]	.107 [2.71]	.617 [15.67]	.110 [2.79]	TIN	TIN
146488	.450 [11.43]	.057 [1.45]	.617 [15.67]	.110 [2.79]	TIN	TIN
146489	.500 [12.70]	.129 [3.27]	.739 [18.77]	.110 [2.79]	TIN	TIN
146490	.300 [7.62]	.109 [2.77]	.739 [18.77]	.330 [8.38]	TIN	15 AU
146491	.600 [15.24]	.107 [2.71]	.817 [20.75]	.110 [2.79]	TIN	TIN
146492	.400 [10.16]	.087 [2.20]	.817 [20.75]	.330 [8.38]	TIN	15 AU
146493	.700 [17.78]	.120 [3.05]	.930 [23.62]	.110 [2.79]	TIN	TIN
146494	.500 [12.70]	.100 [2.54]	.930 [23.62]	.330 [8.38]	TIN	15 AU
146495	.270 [6.86]	.330 [8.38]	.930 [23.62]	.330 [8.38]	15 AU	15 AU
146496	.800 [20.32]	.120 [3.05]	1.030 [26.16]	.110 [2.79]	TIN	TIN
146497	.600 [15.24]	.100 [2.54]	1.030 [26.16]	.330 [8.38]	TIN	15 AU
146498	.370 [9.39]	.330 [8.38]	1.030 [26.16]	.330 [8.38]	15 AU	15 AU
146499	.900 [22.86]	.120 [3.05]	1.130 [28.70]	.110 [2.79]	TIN	TIN
146500	.700 [17.78]	.100 [2.54]	1.130 [28.70]	.330 [8.38]	TIN	15 AU
146501	.470 [11.93]	.330 [8.38]	1.130 [28.70]	.330 [8.38]	15 AU	15 AU
146502	1.000 [25.40]	.120 [3.05]	1.230 [31.24]	.110 [2.79]	TIN	TIN
146503	.800 [20.32]	.100 [2.54]	1.230 [31.24]	.330 [8.38]	TIN	15 AU
146504	.570 [14.74]	.330 [8.38]	1.230 [31.24]	.330 [8.38]	15 AU	15 AU
146505	1.100 [27.94]	.120 [3.05]	1.330 [33.78]	.110 [2.79]	TIN	TIN
146506	.900 [22.86]	.100 [2.54]	1.330 [33.78]	.330 [8.38]	TIN	15 AU
146507	.670 [17.01]	.330 [8.38]	1.330 [33.78]	.330 [8.38]	15 AU	15 AU
146508	1.200 [30.48]	.120 [3.05]	1.430 [36.32]	.110 [2.79]	TIN	TIN
146509	1.000 [25.40]	.100 [2.54]	1.430 [36.32]	.330 [8.38]	TIN	15 AU
146510	.770 [19.55]	.330 [8.38]	1.430 [36.32]	.330 [8.38]	15 AU	15 AU

**Note:** All part numbers are RoHS compliant.

## Standard Profile Headers—Shrouded

### Product Facts

- Available in several styles—right-angle with three- and four-sided pin protection, and straight post with pin protection and mounting ears
- Post retention feature available
- Can be used for feed-to and feed-thru applications
- Housings are black thermoplastic, flame retardant 94V-0 rated
- Contacts are copper alloy
- Available in gold duplex, gold over nickel and tin over nickel platings
- Headers with .066 [1.68] and .150 [3.81] end dimensions are available in select sizes up to 60 positions
- Can be select loaded, consult TE
- Recognized under the Component Program of Underwriters Laboratories Inc. File No. E28476
- Certified by Canadian Standards Association, File No. LR 7189

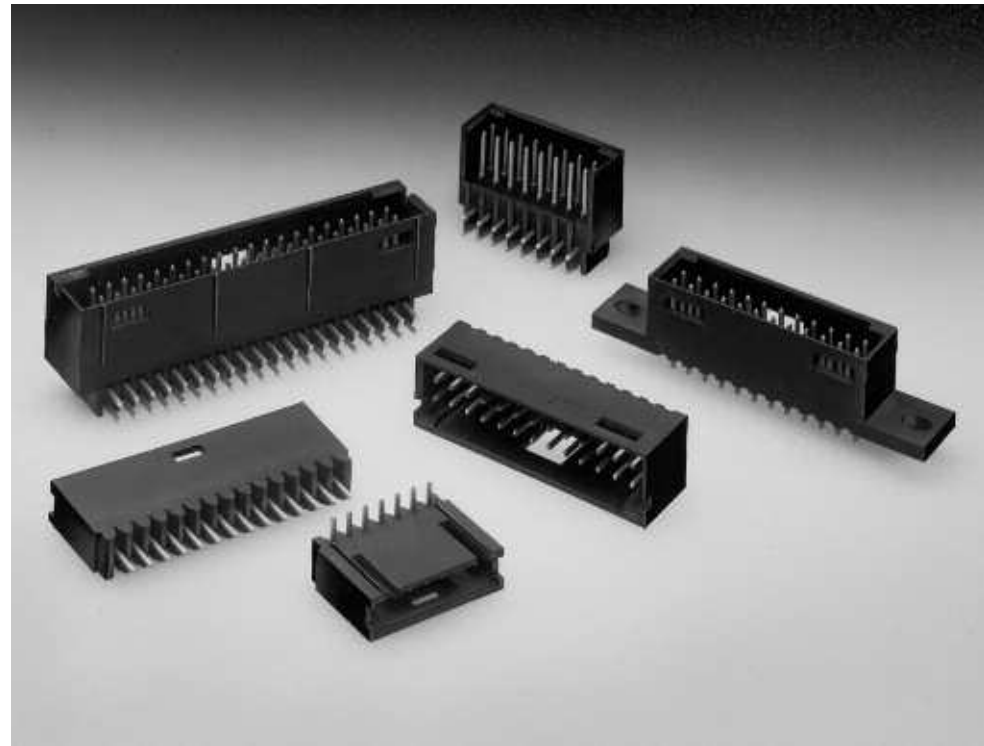

### Performance Characteristics

#### Electrical

**Insulation Resistance** — 5,000 megohms minimum initial

**Dielectric Withstanding Voltage** — 750 RMS at sea level

#### Environmental

**Operating Temperature** — -65°C to +105°C (black thermoplastic housings)

**Current** — 3 amperes maximum per contact

## Standard Profile Headers—Shrouded, Single-Row, .100 [2.54] Centerline

### .025 [0.64] Square Straight Post (with Standoffs)



#### Material and Finish

**Housing** — Black thermoplastic, 94V-0 rated

**Posts** — Phosphor bronze, plated as follows:

**Plating A** — Duplex plated .000030 [0.00076] gold on contact area, .000100-.000200 [0.00254-0.00508] tin on solder area, with entire post under-plated .000050 [0.00127] nickel

**Plating B** — Duplex plated .000015 [0.00038] gold on contact area, .000100-.000200 [0.00254-0.00508] tin on solder area, with entire post under-plated .000050 [0.00127] nickel

**Plating C** — .000100-.000200 [0.00254-0.00508] tin over .000050 [0.00127] nickel on entire post

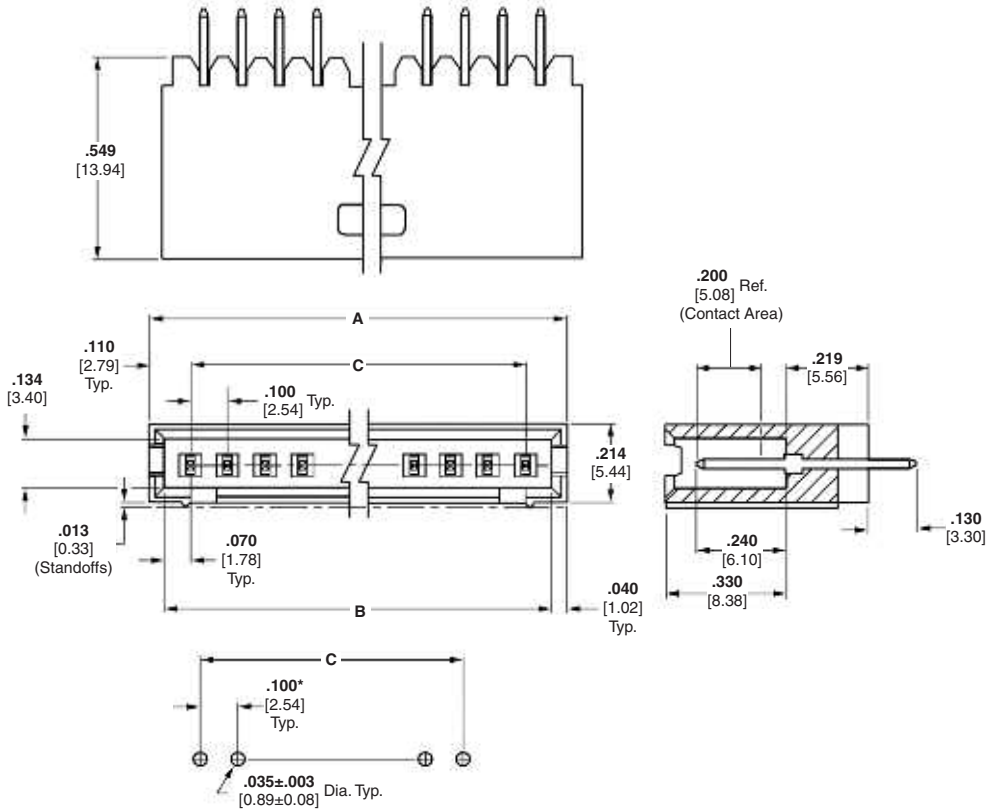

Recommended PC Board Hole Layout (for .055 [1.40] min. thick PC board)

\*±.003 [±0.08] tolerances not to accumulate within one connector pattern.

#### Related Product Data

**Mateable Connectors** —

**AMPMODU Wire-Applied**

**Receptacles** — page 215

**AMPMODU MTE Receptacles** —

pages 228, 229, 234

#### Technical Documents — page 276

See mating connector for applicable product and application specifications.

No. of Pos.	Dimensions			Post Plating/Part Nos.		
	A	B	C	Plating A	Plating B	Plating C
3	.420 [10.67]	.340 [8.64]	.200 [5.08]	5-103414-1	8-102202-1	5-103080-1
4	.520 [13.21]	.440 [11.18]	.300 [7.62]	5-103414-2	5-102202-1	5-103080-2
5	.620 [15.75]	.540 [13.72]	.400 [10.16]	5-103414-3	5-102202-2	5-103080-3
6	.720 [18.29]	.640 [16.26]	.500 [12.70]	5-103414-4	5-102202-3	5-103080-4
7	.820 [20.83]	.740 [18.80]	.600 [15.24]	5-103414-5	5-102202-4	5-103080-5
8	.920 [23.37]	.840 [21.34]	.700 [17.78]	5-103414-6	5-102202-5	5-103080-6
9	1.020 [25.91]	.940 [23.88]	.800 [20.32]	5-103414-7	5-102202-6	5-103080-7
10	1.120 [28.45]	1.040 [26.42]	.900 [22.86]	5-103414-8	5-102202-7	5-103080-8
11	1.220 [30.99]	1.140 [28.96]	1.000 [25.40]	5-103414-9	5-102202-8	5-103080-9
12	1.320 [33.53]	1.240 [31.50]	1.100 [27.94]	6-103414-0	5-102202-9	6-103080-0
13	1.420 [36.07]	1.340 [34.04]	1.200 [30.48]	6-103414-1	6-102202-0	6-103080-1
14	1.520 [38.61]	1.440 [36.58]	1.300 [33.02]	6-103414-2	6-102202-1	6-103080-2
15	1.620 [41.15]	1.540 [39.12]	1.400 [35.56]	6-103414-3	6-102202-2	6-103080-3
16	1.720 [43.69]	1.640 [41.66]	1.500 [38.10]	6-103414-4	6-102202-3	6-103080-4
17	1.820 [46.23]	1.740 [44.20]	1.600 [40.64]	6-103414-5	6-102202-4	6-103080-5
18	1.920 [48.77]	1.840 [46.74]	1.700 [43.18]	6-103414-6	6-102202-5	6-103080-6
19	2.020 [51.31]	1.940 [49.28]	1.800 [45.72]	6-103414-7	6-102202-6	6-103080-7
20	2.120 [53.85]	2.040 [51.82]	1.900 [48.26]	6-103414-8	6-102202-7	6-103080-8
21	2.220 [56.39]	2.140 [54.36]	2.000 [50.80]	6-103414-9	6-102202-8	6-103080-9
22	2.320 [58.93]	2.240 [56.90]	2.100 [53.34]	7-103414-0	6-102202-9	7-103080-0
23	2.420 [61.47]	2.340 [59.44]	2.200 [55.88]	7-103414-1	7-102202-0	7-103080-1
24	2.520 [64.01]	2.440 [61.98]	2.300 [58.42]	7-103414-2	7-102202-1	7-103080-2
25	2.620 [66.55]	2.540 [64.52]	2.400 [60.96]	7-103414-3	7-102202-2	7-103080-3

**Note:** All part numbers are RoHS compliant.

## Standard Profile Headers—Shrouded, Single-Row, .100 [2.54] Centerline (Continued)

### .025 [0.64] Square Right-Angle Post (with Standoffs)

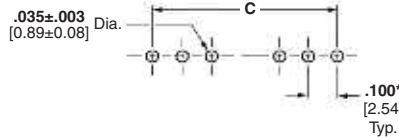
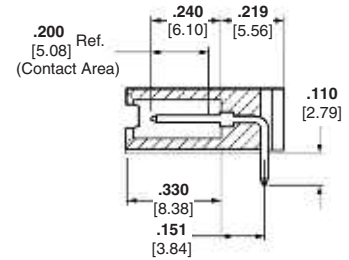
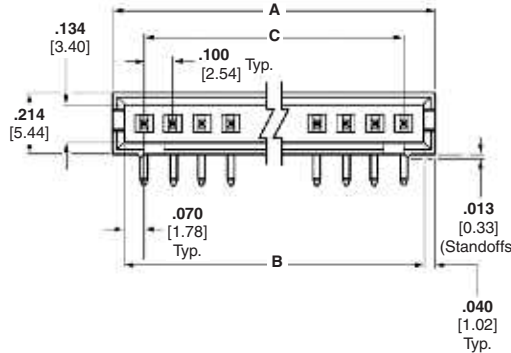
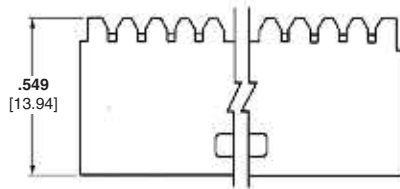

**Recommended PC Board Hole Layout (for .055 [1.40] min. thick PC board)**

\*±.003 [±0.08] tolerances not to accumulate within one connector pattern.

### Material and Finish

**Housing** — Black thermoplastic, 94V-0 rated

**Posts** — Phosphor bronze, plated as follows:

**Plating A** — Duplex plated .000030 [0.00076] gold on contact area, .000100-.000200 [0.00254-0.00508] tin on solder area, with entire post underplated .000050 [0.00127] nickel

**Plating B** — Duplex plated .000015 [0.00038] gold on contact area, .000100-.000200 [0.00254-0.00508] tin on solder area, with entire post underplated .000050 [0.00127] nickel

**Plating C** — .000100-.000200 [0.00254-0.00508] tin over .000050 [0.00127] nickel on entire post

### Related Product Data

**Mateable Connectors** — AMPMODU Wire-Applied Receptacles — page 215

**AMPMODU MTE Receptacles** — pages 228, 229, 234

### Technical Documents — page 276

See mating connector for applicable product and application specifications.

No. of Pos.	Dimensions			Post Plating/Part Nos.		
	A	B	C	Plating A	Plating B	Plating C
3	.420 [10.67]	.340 [8.64]	.200 [5.08]	5-103361-1	8-102203-4	5-102523-1
4	.520 [13.21]	.440 [11.18]	.300 [7.62]	5-103361-2	5-102203-1	5-102523-2
5	.620 [15.75]	.540 [13.72]	.400 [10.16]	5-103361-3	5-102203-2	5-102523-3
6	.720 [18.29]	.640 [16.26]	.500 [12.70]	5-103361-4	5-102203-3	5-102523-4
7	.820 [20.83]	.740 [18.80]	.600 [15.24]	5-103361-5	5-102203-4	5-102523-5
8	.920 [23.37]	.840 [21.34]	.700 [17.78]	5-103361-6	5-102203-5	5-102523-6
9	1.020 [25.91]	.940 [23.88]	.800 [20.32]	5-103361-7	5-102203-6	5-102523-7
10	1.120 [28.45]	1.040 [26.42]	.900 [22.86]	5-103361-8	5-102203-7	5-102523-8
11	1.220 [30.99]	1.140 [28.96]	1.000 [25.40]	5-103361-9	5-102203-8	5-102523-9
12	1.320 [33.53]	1.240 [31.50]	1.100 [27.94]	6-103361-0	5-102203-9	6-102523-0
13	1.420 [36.07]	1.340 [34.04]	1.200 [30.48]	6-103361-1	6-102203-0	6-102523-1
14	1.520 [38.61]	1.440 [36.58]	1.300 [33.02]	6-103361-2	6-102203-1	6-102523-2
15	1.620 [41.15]	1.540 [39.12]	1.400 [35.56]	6-103361-3	6-102203-2	6-102523-3
16	1.720 [43.69]	1.640 [41.66]	1.500 [38.10]	6-103361-4	6-102203-3	6-102523-4
17	1.820 [46.23]	1.740 [44.20]	1.600 [40.64]	6-103361-5	6-102203-4	6-102523-5
18	1.920 [48.77]	1.840 [46.74]	1.700 [43.18]	6-103361-6	6-102203-5	6-102523-6
19	2.020 [51.31]	1.940 [49.28]	1.800 [45.72]	6-103361-7	6-102203-6	6-102523-7
20	2.120 [53.85]	2.040 [51.82]	1.900 [48.26]	6-103361-8	6-102203-7	6-102523-8
21	2.220 [56.39]	2.140 [54.36]	2.000 [50.80]	6-103361-9	6-102203-8	6-102523-9
22	2.320 [58.93]	2.240 [56.90]	2.100 [53.34]	7-103361-0	6-102203-9	7-102523-0
23	2.420 [61.47]	2.340 [59.44]	2.200 [55.88]	7-103361-1	7-102203-0	7-102523-1
24	2.520 [64.01]	2.440 [61.98]	2.300 [58.42]	7-103361-2	7-102203-1	7-102523-2
25	2.620 [66.55]	2.540 [64.52]	2.400 [60.96]	7-103361-3	7-102203-2	7-102523-3

**Note:** All part numbers are RoHS compliant.

## Standard Profile Headers—Shrouded, with .066 [1.68] End Dimension, Double-Row, .100 x .100 [2.54 x 2.54] Centerline

### .025 [0.64] Square Straight Post (with Detent Windows)



#### Material and Finish

**Housing** — Black thermoplastic, 94V-0 rated

**Posts** — Phosphor bronze, plated as follows:

**Plating A** — Duplex plated .000030 [0.00076] gold on contact area, .000100-.000200 [0.00254-0.00508] tin on solder area, with entire post underplated .000050 [0.00127] nickel

**Plating B** — Duplex plated .000015 [0.00038] gold on contact area, .000100-.000200 [0.00254-0.00508] tin on solder area, with entire post underplated .000050 [0.00127] nickel

**Plating C** — .000100-.000200 [0.00254-0.00508] tin over .000050 [0.00127] nickel on entire post

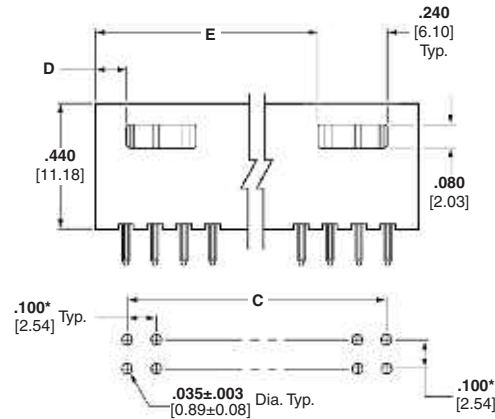
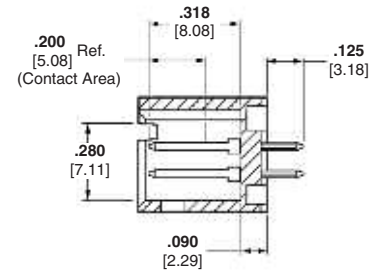
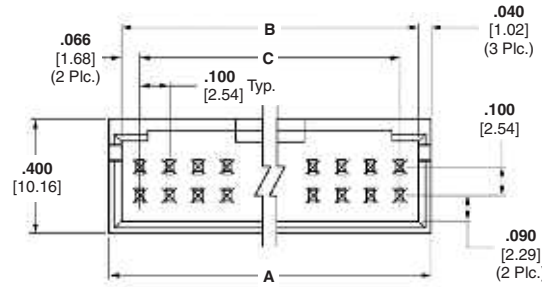

**Recommended PC Board Hole Layout**  
(for .055 [1.40] min. thick PC board)

\*±.003 [±0.08] tolerances not to accumulate within one connector pattern.

#### Related Product Data

**Mateable Connectors** —

**AMPMODU Board Mount Receptacles** — pages 176, 179, 180

**AMPMODU Wire-Applied Receptacles** — pages 216-219

**AMPMODU MTE Receptacles** — pages 228, 229, 234

**AMPMODU MT Receptacles** — pages 256, 257

#### Accessories

**Barrier Insert** — page 204

**Technical Documents** — page 276

See mating connector for applicable product and application specifications.

No. of Pos.	Dimensions					Post Plating/Part Nos.		
	A	B	C	D	E	Plating A	Plating B	Plating C
6	.412 [10.46]	.332 [8.43]	.200 [5.08]	.106 [2.69]	—	5-103168-1	5-102618-1	8-87589-6
8	.512 [13.00]	.432 [10.97]	.300 [7.62]	.106 [2.69]	—	5-103168-2	5-102618-2	8-87589-5
10	.612 [15.54]	.532 [13.51]	.400 [10.16]	.206 [5.23]	—	5-103168-3	5-102618-3	5-87589-1
12	.712 [18.08]	.632 [16.05]	.500 [12.70]	.206 [5.23]	—	5-103168-4	5-102618-4	5-87589-2
14	.812 [20.62]	.732 [18.59]	.600 [15.24]	.306 [7.77]	—	5-103168-5	5-102618-5	5-87589-3
16	.912 [23.16]	.832 [21.13]	.700 [17.78]	.306 [7.77]	—	5-103168-6	5-102618-6	5-87589-4
18	1.012 [25.70]	.932 [23.67]	.800 [20.32]	.406 [10.31]	—	5-103168-7	5-102618-7	5-87589-5
20	1.112 [28.24]	1.032 [26.21]	.900 [22.86]	.106 [2.69]	.806 [20.47]	5-103168-8	5-102618-8	5-87589-6
22	1.212 [30.78]	1.132 [28.75]	1.000 [25.40]	.106 [2.69]	.906 [23.01]	5-103168-9	5-102618-9	5-87589-7
24	1.312 [33.32]	1.232 [31.29]	1.100 [27.94]	.106 [2.69]	1.006 [25.55]	6-103168-0	6-102618-0	5-87589-8
26	1.412 [35.86]	1.332 [33.83]	1.200 [30.48]	.106 [2.69]	1.106 [28.09]	6-103168-1	6-102618-1	5-87589-9
28	1.512 [38.40]	1.432 [36.37]	1.300 [33.02]	.106 [2.69]	1.206 [30.63]	6-103168-2	6-102618-2	6-87589-0
30	1.612 [40.94]	1.532 [38.91]	1.400 [35.56]	.106 [2.69]	1.306 [33.17]	6-103168-3	6-102618-3	6-87589-1

**Note:** All part numbers are RoHS compliant.

**Standard Profile Headers—Shrouded, with .066 [1.68]  
End Dimension, Double-Row, .100 x .100 [2.54 x 2.54] Centerline** (Continued)

No. of Positions	Dimensions					Post Plating/Part Nos.		
	A	B	C	D	E	Plating A	Plating B	Plating C
32	1.712 [43.48]	1.632 [41.45]	1.500 [38.10]	.106 [2.69]	1.406 [35.71]	6-103168-4	6-102618-4	6-87589-2
34	1.812 [46.02]	1.732 [43.99]	1.600 [40.64]	.106 [2.69]	1.506 [38.25]	6-103168-5	6-102618-5	6-87589-3
36	1.912 [48.56]	1.832 [46.53]	1.700 [43.18]	.106 [2.69]	1.606 [40.79]	6-103168-6	6-102618-6	6-87589-4
38	2.012 [51.10]	1.932 [49.07]	1.800 [45.72]	.106 [2.69]	1.706 [43.33]	6-103168-7	6-102618-7	6-87589-5
40	2.112 [53.64]	2.032 [51.61]	1.900 [48.26]	.106 [2.69]	1.806 [45.87]	6-103168-8	6-102618-8	6-87589-6
42	2.212 [56.18]	2.132 [54.15]	2.000 [50.80]	.106 [2.69]	1.906 [48.41]	6-103168-9	6-102618-9	6-87589-7
44	2.312 [58.72]	2.232 [56.69]	2.100 [53.34]	.106 [2.69]	2.006 [50.95]	7-103168-0	7-102618-0	6-87589-8
46	2.412 [61.26]	2.332 [59.23]	2.200 [55.88]	.106 [2.69]	2.106 [53.49]	7-103168-1	7-102618-1	6-87589-9
48	2.512 [63.80]	2.432 [61.77]	2.300 [58.42]	.106 [2.69]	2.206 [56.03]	7-103168-2	7-102618-2	7-87589-0
50	2.612 [66.34]	2.532 [64.31]	2.400 [60.96]	.106 [2.69]	2.306 [58.57]	7-103168-3	7-102618-3	7-87589-1
52	2.712 [68.88]	2.632 [66.85]	2.500 [63.50]	.106 [2.69]	2.406 [61.11]	7-103168-4	7-102618-4	7-87589-2
54	2.812 [71.42]	2.732 [69.39]	2.600 [66.04]	.106 [2.69]	2.506 [63.65]	7-103168-5	7-102618-5	7-87589-3
56	2.912 [73.96]	2.832 [71.93]	2.700 [68.58]	.106 [2.69]	2.606 [66.19]	7-103168-6	7-102618-6	7-87589-4
58	3.012 [76.50]	2.932 [74.47]	2.800 [71.12]	.106 [2.69]	2.706 [68.73]	7-103168-7	7-102618-7	7-87589-5
60	3.112 [79.04]	3.032 [77.01]	2.900 [73.66]	.106 [2.69]	2.806 [71.27]	7-103168-8	7-102618-8	7-87589-6
62	3.212 [81.58]	3.132 [79.55]	3.000 [76.20]	.106 [2.69]	2.906 [73.81]	7-103168-9	7-102618-9	7-87589-7
64	3.312 [84.12]	3.232 [82.09]	3.100 [78.74]	.106 [2.69]	3.006 [76.35]	8-103168-0	8-102618-0	7-87589-8
66	3.412 [86.66]	3.332 [84.63]	3.200 [81.28]	.106 [2.69]	3.106 [78.89]	8-103168-1	8-102618-1	7-87589-9
68	3.512 [89.20]	3.432 [87.17]	3.300 [83.82]	.106 [2.69]	3.206 [81.43]	8-103168-2	8-102618-2	8-87589-0
70	3.612 [91.74]	3.532 [89.71]	3.400 [86.36]	.106 [2.69]	3.306 [83.97]	8-103168-3	8-102618-3	8-87589-1
72	3.712 [94.28]	3.632 [92.25]	3.500 [88.90]	.106 [2.69]	3.406 [86.51]	8-103168-4	8-102618-4	8-87589-2
74	3.812 [96.82]	3.732 [94.79]	3.600 [91.44]	.106 [2.69]	3.506 [89.05]	8-103168-5	8-102618-5	8-87589-3

Standard Profile Headers,  
Shrouded

5

## Standard Profile Headers—Shrouded, with .150 [3.81] End Dimension, Double-Row, .100 x .100 [2.54 x 2.54] Centerline

### .025 [0.64] Square Straight Post (with Detent Windows)

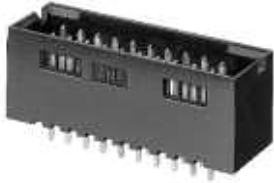

#### Material and Finish

**Housing** — Black thermoplastic, 94V-0 rated

**Posts** — Phosphor bronze, plated as follows:

**Plating A** — Duplex plated .000030 [0.00076] gold on contact area, .000100-.000200 [0.00254-0.00508] tin on solder area, with entire post underplated .000050 [0.00127] nickel

**Plating B** — Duplex plated .000015 [0.00038] gold on contact area, .000100-.000200 [0.00254-0.00508] tin on solder area, with entire post underplated .000050 [0.00127] nickel

**Plating C** — .000100-.000200 [0.00254-0.00508] tin over .000050 [0.00127] nickel on entire post

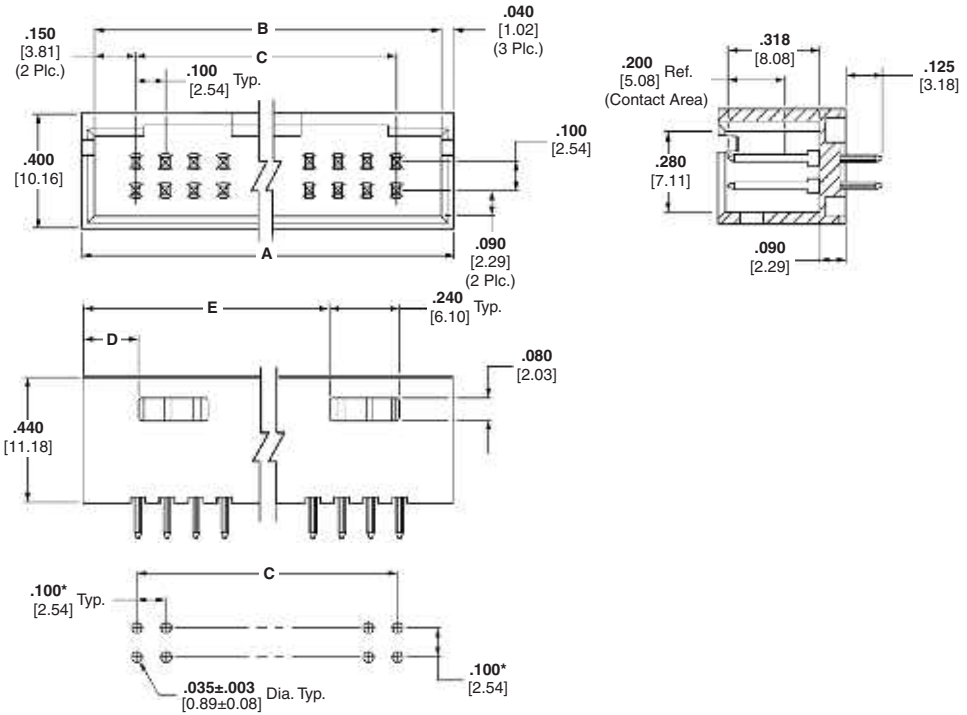

**Recommended PC Board Hole Layout (for .055 [1.40] min. thick PC board)**

\*±.003 [±0.08] tolerances not to accumulate within one connector pattern.

#### Related Product Data

##### Mateable Connectors

**AMPMODU MTE Receptacles** — pages 232, 233, 235 (used with coupling shroud on page 241)

**AMPMODU Wire-Applied Receptacles** — pages 216-219

#### Accessories

**Barrier Insert** — page 204

#### Technical Documents — page 276

See mating connector for applicable product and application specifications.

No. of Pos.	Dimensions					Post Plating/Part Nos.		
	A	B	C	D	E	Plating A	Plating B	Plating C
6	.580 [14.73]	.500 [12.70]	.200 [5.08]	.190 [4.83]	—	5-103169-1	5-102619-1	8-87587-3
8	.680 [17.27]	.600 [15.24]	.300 [7.62]	.190 [4.83]	—	5-103169-2	5-102619-2	8-87587-4
10	.780 [19.81]	.700 [17.78]	.400 [10.16]	.290 [7.37]	—	5-103169-3	5-102619-3	5-87587-1
12	.880 [22.35]	.800 [20.32]	.500 [12.70]	.290 [7.37]	—	5-103169-4	5-102619-4	5-87587-2
14	.980 [24.89]	.900 [22.86]	.600 [15.24]	.390 [9.91]	—	5-103169-5	5-102619-5	5-87587-3
16	1.080 [27.43]	1.000 [25.40]	.700 [17.78]	.390 [9.91]	—	5-103169-6	5-102619-6	5-87587-4
18	1.180 [29.97]	1.100 [27.94]	.800 [20.32]	.490 [12.45]	—	5-103169-7	5-102619-7	5-87587-5
20	1.280 [32.51]	1.200 [30.48]	.900 [22.86]	.190 [4.83]	.890 [22.61]	5-103169-8	5-102619-8	5-87587-6
22	1.380 [35.05]	1.300 [33.02]	1.000 [25.40]	.190 [4.83]	.990 [25.15]	5-103169-9	5-102619-9	5-87587-7
24	1.480 [37.59]	1.400 [35.56]	1.100 [27.94]	.190 [4.83]	1.090 [27.69]	6-103169-0	6-102619-0	5-87587-8
26	1.580 [40.13]	1.500 [38.10]	1.200 [30.48]	.190 [4.83]	1.190 [30.23]	6-103169-1	6-102619-1	5-87587-9
28	1.680 [42.67]	1.600 [40.64]	1.300 [33.02]	.190 [4.83]	1.290 [32.77]	6-103169-2	6-102619-2	6-87587-0
30	1.780 [45.21]	1.700 [43.18]	1.400 [35.56]	.190 [4.83]	1.390 [35.31]	6-103169-3	6-102619-3	6-87587-1

**Note:** All part numbers are RoHS compliant.

**Standard Profile Headers—Shrouded, with .150 [3.81] End Dimension, Double-Row, .100 x .100 [2.54 x 2.54] Centerline** (Continued)

No. of Pos.	Dimensions					Post Plating/Part Nos.		
	A	B	C	D	E	Plating A	Plating B	Plating C
32	1.880 [47.75]	1.800 [45.72]	1.500 [38.10]	.190 [4.83]	1.490 [37.85]	6-103169-4	6-102619-4	6-87587-2
34	1.980 [50.29]	1.900 [48.26]	1.600 [40.64]	.190 [4.83]	1.590 [40.39]	6-103169-5	6-102619-5	6-87587-3
36	2.080 [52.83]	2.000 [50.80]	1.700 [43.18]	.190 [4.83]	1.690 [42.93]	6-103169-6	6-102619-6	6-87587-4
38	2.180 [55.37]	2.100 [53.34]	1.800 [45.72]	.190 [4.83]	1.790 [45.47]	6-103169-7	6-102619-7	6-87587-5
40	2.280 [57.91]	2.200 [55.88]	1.900 [48.26]	.190 [4.83]	1.890 [48.01]	6-103169-8	6-102619-8	6-87587-6
42	2.380 [60.45]	2.300 [58.42]	2.000 [50.80]	.190 [4.83]	1.990 [50.55]	6-103169-9	6-102619-9	6-87587-7
44	2.480 [62.99]	2.400 [60.96]	2.100 [53.34]	.190 [4.83]	2.090 [53.09]	7-103169-0	7-102619-0	6-87587-8
46	2.580 [65.53]	2.500 [63.50]	2.200 [55.88]	.190 [4.83]	2.190 [55.63]	7-103169-1	7-102619-1	6-87587-9
48	2.680 [68.07]	2.600 [66.04]	2.300 [58.42]	.190 [4.83]	2.290 [58.17]	7-103169-2	7-102619-2	7-87587-0
50	2.780 [70.61]	2.700 [68.58]	2.400 [60.96]	.190 [4.83]	2.390 [60.71]	7-103169-3	7-102619-3	7-87587-1
52	2.880 [73.15]	2.800 [71.12]	2.500 [63.50]	.190 [4.83]	2.490 [63.25]	7-103169-4	7-102619-4	7-87587-2
54	2.980 [75.69]	2.900 [73.66]	2.600 [66.04]	.190 [4.83]	2.590 [65.79]	7-103169-5	7-102619-5	7-87587-3
56	3.080 [78.23]	3.000 [76.20]	2.700 [68.58]	.190 [4.83]	2.690 [68.33]	7-103169-6	7-102619-6	7-87587-4
58	3.180 [80.77]	3.100 [78.74]	2.800 [71.12]	.190 [4.83]	2.790 [70.87]	7-103169-7	7-102619-7	7-87587-5
60	3.280 [83.31]	3.200 [81.28]	2.900 [73.66]	.190 [4.83]	2.890 [73.41]	7-103169-8	7-102619-8	7-87587-6
62	3.380 [85.85]	3.300 [83.82]	3.000 [76.20]	.190 [4.83]	2.990 [75.95]	7-103169-9	7-102619-9	7-87587-7
64	3.480 [88.39]	3.400 [86.36]	3.100 [78.74]	.190 [4.83]	3.090 [78.49]	8-103169-0	8-102619-0	7-87587-8
66	3.580 [90.93]	3.500 [88.90]	3.200 [81.28]	.190 [4.83]	3.190 [81.03]	8-103169-1	8-102619-1	7-87587-9
68	3.680 [93.47]	3.600 [91.44]	3.300 [83.82]	.190 [4.83]	3.290 [83.57]	8-103169-2	8-102619-2	8-87587-0
70	3.780 [96.01]	3.700 [93.98]	3.400 [86.36]	.190 [4.83]	3.390 [86.11]	8-103169-3	8-102619-3	8-87587-1
72	3.880 [98.55]	3.800 [96.52]	3.500 [88.90]	.190 [4.83]	3.490 [88.65]	8-103169-4	8-102619-4	8-87587-2

**Note:** All part numbers are RoHS compliant.



## Standard Profile Headers—Shrouded, with .150 [3.81] End Dimension, Double-Row, .100 x .100 [2.54 x 2.54] Centerline (Continued)

### .025 [0.64] Square Straight Post (with Plastic Holddowns)

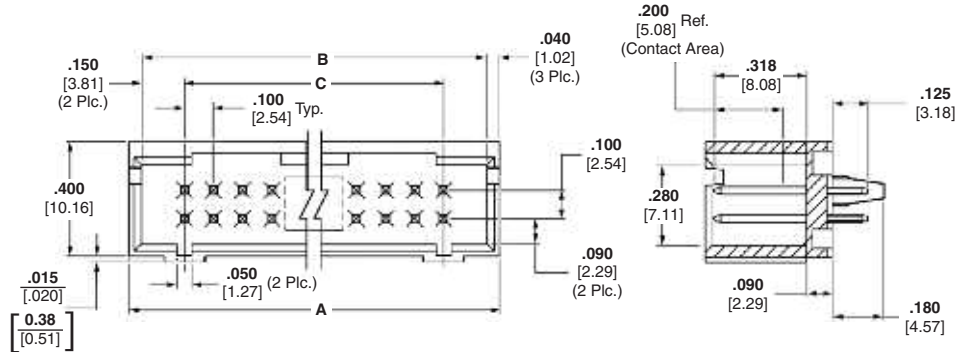

### Material and Finish

**Housing** — Black thermoplastic, 94V-0 rated

**Posts** — Phosphor bronze, duplex plated .000015 [0.00038] gold on contact area, .000100-.000200 [0.00254-0.00508] tin on solder area, with entire post underplated .000050 [0.00127] nickel

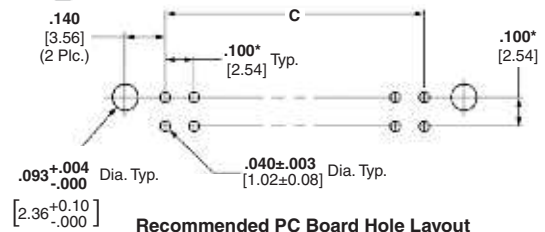
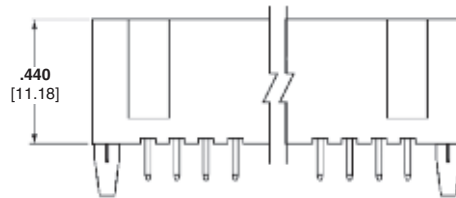

**Recommended PC Board Hole Layout (for .055 [1.40] min. thick PC board)**

\*±.003 [±0.08] tolerances not to accumulate within one connector pattern.

### Related Product Data

#### Mateable Connectors

**AMPMODU MTE Receptacles** — pages 232, 233, 235 (used with coupling shroud on page 241)

**AMPMODU Wire-Applied Receptacles** — pages 216-219

### Accessories

**Barrier Insert** — page 204

### Technical Documents

See mating connector for applicable product and application specifications.

No. of Pos.	Dimensions			Part Nos. Plating A
	A	B	C	
6	.580 [14.73]	.500 [12.70]	.200 [5.08]	5-104317-1
10	.780 [19.81]	.700 [17.78]	.400 [10.16]	5-104317-2
12	.880 [22.35]	.800 [20.32]	.500 [12.70]	5-104317-3
14	.980 [24.89]	.900 [22.86]	.600 [15.24]	5-104317-4
16	1.080 [27.43]	1.000 [25.40]	.700 [17.78]	6-104317-6
18	1.180 [29.97]	1.100 [27.94]	.800 [20.32]	5-104317-5
20	1.280 [32.51]	1.200 [30.48]	.900 [22.86]	5-104317-6
22	1.380 [35.05]	1.300 [33.02]	1.000 [25.40]	5-104317-7
24	1.480 [37.59]	1.400 [35.56]	1.100 [27.94]	5-104317-8
26	1.580 [40.13]	1.500 [38.10]	1.200 [30.48]	5-104317-9
30	1.780 [45.21]	1.700 [43.18]	1.400 [35.56]	6-104317-0
32	1.880 [47.75]	1.800 [45.72]	1.500 [38.10]	6-104317-1
34	1.980 [50.29]	1.900 [48.26]	1.600 [40.64]	6-104317-8
36	2.080 [52.83]	2.000 [50.80]	1.700 [43.18]	6-104317-7
40	2.280 [57.91]	2.200 [55.88]	1.900 [48.26]	6-104317-2
42	2.380 [60.45]	2.300 [58.42]	2.000 [50.80]	6-104317-5
48	2.680 [68.07]	2.600 [66.04]	2.300 [58.42]	6-104317-3
50	2.780 [70.61]	2.700 [68.58]	2.400 [60.96]	6-104317-4

**Note:** All part numbers are RoHS compliant.

## Standard Profile Headers—Shrouded, with .066 [1.68] End Dimension, Double-Row, .100 x .100 [2.54 x 2.54] Centerline

### .025 [0.64] Square Right-Angle Post (with Detent Windows)

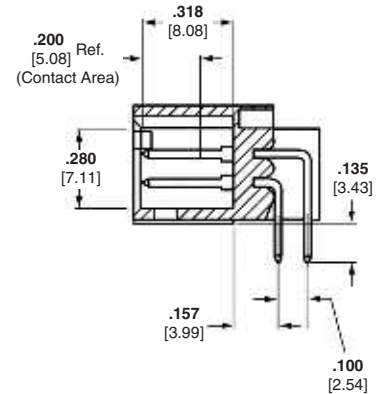
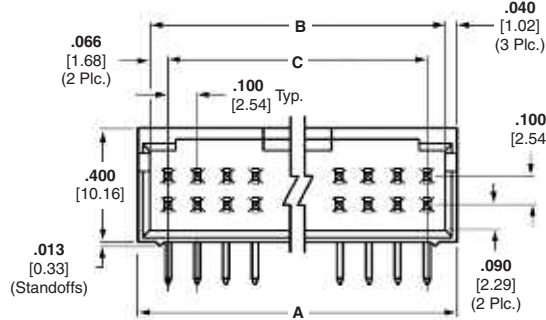

#### Material and Finish

**Housing** — Black thermoplastic, 94V-0 rated

**Posts** — Phosphor bronze, plated as follows:

**Plating A** — Duplex plated .000030 [0.00076] gold on contact area, .000100-.000200 [0.00254-0.00508] tin on solder area, with entire post underplated .000050 [0.00127] nickel

**Plating B** — Duplex plated .000015 [0.00038] gold on contact area, .000100-.000200 [0.00254-0.00508] tin on solder area, with entire post underplated .000050 [0.00127] nickel

**Plating C** — .000100-.000200 [0.00254-0.00508] tin over .000050 [0.00127] nickel on entire post

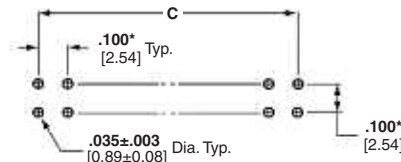
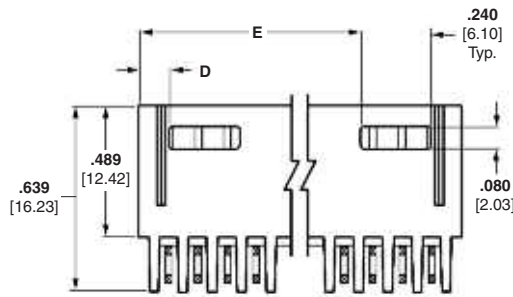

**Recommended PC Board Hole Layout (for .055 [1.40] min. thick PC board)**

\*±.003 [±0.08] tolerances not to accumulate within one connector pattern.

#### Related Product Data

##### Mateable Connectors

##### AMPMODU Board Mount Receptacles

— pages 176, 179, 180

##### AMPMODU Wire-Applied Receptacles

— pages 216-219

##### AMPMODU MTE Receptacles

— pages 228, 229, 234

##### AMPMODU MT Receptacles

— pages 256, 257

#### Technical Documents — page 276

See mating connector for applicable product and application specifications.

No. of Pos.	Dimensions					Post Plating/Part Nos.		
	A	B	C	D	E	Plating A	Plating B	Plating C
6	.412 [10.46]	.332 [8.43]	.200 [5.08]	.106 [2.69]	—	5-103166-1	5-102617-1	8-87579-5
8	.512 [13.00]	.432 [10.97]	.300 [7.62]	.106 [2.69]	—	5-103166-2	5-102617-2	5-87579-1
10	.612 [15.54]	.532 [13.51]	.400 [10.16]	.206 [5.23]	—	5-103166-3	5-102617-3	5-87579-2
12	.712 [18.08]	.632 [16.05]	.500 [12.70]	.206 [5.23]	—	5-103166-4	5-102617-4	5-87579-3
14	.812 [20.62]	.732 [18.59]	.600 [15.24]	.306 [7.77]	—	5-103166-5	5-102617-5	5-87579-4
16	.912 [23.16]	.832 [21.13]	.700 [17.78]	.306 [7.77]	—	5-103166-6	5-102617-6	5-87579-5
18	1.012 [25.70]	.932 [23.67]	.800 [20.32]	.406 [10.31]	—	5-103166-7	5-102617-7	5-87579-6
20	1.112 [28.24]	1.032 [26.21]	.900 [22.86]	.106 [2.69]	.806 [20.47]	5-103166-8	5-102617-8	5-87579-7
22	1.212 [30.78]	1.132 [28.75]	1.000 [25.40]	.106 [2.69]	.906 [23.01]	5-103166-9	5-102617-9	5-87579-8
24	1.312 [33.32]	1.232 [31.29]	1.100 [27.94]	.106 [2.69]	1.006 [25.55]	6-103166-0	6-102617-0	5-87579-9
26	1.412 [35.86]	1.332 [33.83]	1.200 [30.48]	.106 [2.69]	1.106 [28.09]	6-103166-1	6-102617-1	6-87579-0
28	1.512 [38.40]	1.432 [36.37]	1.300 [33.02]	.106 [2.69]	1.206 [30.63]	6-103166-2	6-102617-2	6-87579-1
30	1.612 [40.94]	1.532 [38.91]	1.400 [35.56]	.106 [2.69]	1.306 [33.17]	6-103166-3	6-102617-3	6-87579-2

**Note:** All part numbers are RoHS compliant.

**Standard Profile Headers—Shrouded, with .066 [1.68] End Dimension, Double-Row, .100 x .100 [2.54 x 2.54] Centerline** (Continued)

No. of Pos.	Dimensions					Post Plating/Part Nos.		
	A	B	C	D	E	Plating A	Plating B	Plating C
32	1.712 [43.48]	1.632 [41.45]	1.500 [38.10]	.106 [2.69]	1.406 [35.71]	6-103166-4	6-102617-4	6-87579-3
34	1.812 [46.02]	1.732 [43.99]	1.600 [40.64]	.106 [2.69]	1.506 [38.25]	6-103166-5	6-102617-5	6-87579-4
36	1.912 [48.56]	1.832 [46.53]	1.700 [43.18]	.106 [2.69]	1.606 [40.79]	6-103166-6	6-102617-6	6-87579-5
38	2.012 [51.10]	1.932 [49.07]	1.800 [45.72]	.106 [2.69]	1.706 [43.33]	6-103166-7	6-102617-7	6-87579-6
40	2.112 [53.64]	2.032 [51.61]	1.900 [48.26]	.106 [2.69]	1.806 [45.87]	6-103166-8	6-102617-8	6-87579-7
42	2.212 [56.18]	2.132 [54.15]	2.000 [50.80]	.106 [2.69]	1.906 [48.41]	6-103166-9	6-102617-9	6-87579-8
44	2.312 [58.72]	2.232 [56.69]	2.100 [53.34]	.106 [2.69]	2.006 [50.95]	7-103166-0	7-102617-0	6-87579-9
46	2.412 [61.26]	2.332 [59.23]	2.200 [55.88]	.106 [2.69]	2.106 [53.49]	7-103166-1	7-102617-1	7-87579-0
48	2.512 [63.80]	2.432 [61.77]	2.300 [58.42]	.106 [2.69]	2.206 [56.03]	7-103166-2	7-102617-2	7-87579-1
50	2.612 [66.34]	2.532 [64.31]	2.400 [60.96]	.106 [2.69]	2.306 [58.57]	7-103166-3	7-102617-3	7-87579-2
52	2.712 [68.88]	2.632 [66.85]	2.500 [63.50]	.106 [2.69]	2.406 [61.11]	7-103166-4	7-102617-4	7-87579-3
54	2.812 [71.42]	2.732 [69.39]	2.600 [66.04]	.106 [2.69]	2.506 [63.65]	7-103166-5	7-102617-5	7-87579-4
56	2.912 [73.96]	2.832 [71.93]	2.700 [68.58]	.106 [2.69]	2.606 [66.19]	7-103166-6	7-102617-6	7-87579-5
58	3.012 [76.50]	2.932 [74.47]	2.800 [71.12]	.106 [2.69]	2.706 [68.73]	7-103166-7	7-102617-7	7-87579-6
60	3.112 [79.04]	3.032 [77.01]	2.900 [73.66]	.106 [2.69]	2.806 [71.27]	7-103166-8	7-102617-8	7-87579-7
62	3.212 [81.58]	3.132 [79.55]	3.000 [76.20]	.106 [2.69]	2.906 [73.81]	7-103166-9	7-102617-9	7-87579-8
64	3.312 [84.12]	3.232 [82.09]	3.100 [78.74]	.106 [2.69]	3.006 [76.35]	8-103166-0	8-102617-0	7-87579-9
66	3.412 [86.66]	3.332 [84.63]	3.200 [81.28]	.106 [2.69]	3.106 [78.89]	8-103166-1	8-102617-1	8-87579-0
68	3.512 [89.20]	3.432 [87.17]	3.300 [83.82]	.106 [2.69]	3.206 [81.43]	8-103166-2	8-102617-2	8-87579-1
70	3.612 [91.74]	3.532 [89.71]	3.400 [86.36]	.106 [2.69]	3.306 [83.97]	8-103166-3	8-102617-3	8-87579-2
72	3.712 [94.28]	3.632 [92.25]	3.500 [88.90]	.106 [2.69]	3.406 [86.51]	8-103166-4	8-102617-4	8-87579-3
74	3.812 [96.82]	3.732 [94.79]	3.600 [91.44]	.106 [2.69]	3.506 [89.05]	8-103166-5	8-102617-5	8-87579-4

Standard Profile Headers, Shrouded

5

**Note:** All part numbers are RoHS compliant.

## Standard Profile Headers—Shrouded, with .150 [3.81] End Dimension, Double-Row, .100 x .100 [2.54 x 2.54] Centerline

### .025 [0.64] Square Right-Angle Post (with Detent Windows)

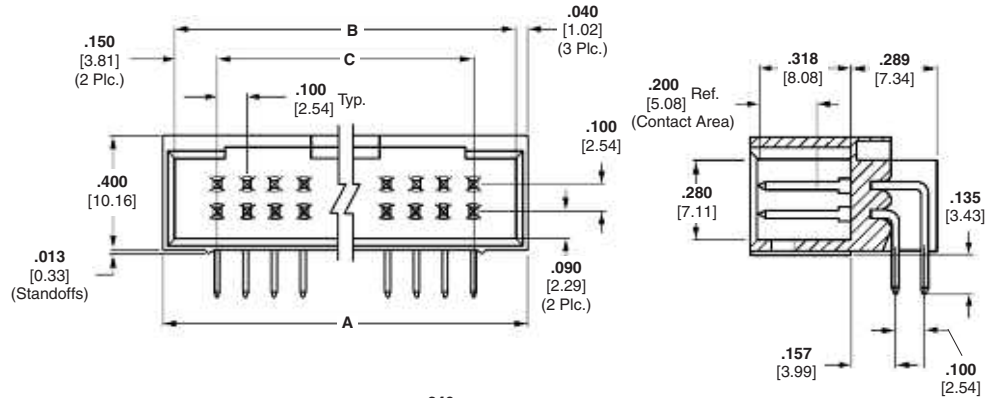

#### Material and Finish

**Housing** — Black thermoplastic, 94V-0 rated

**Posts** — Phosphor bronze, plated as follows:

**Plating A** — Duplex plated .000030 [0.00076] gold on contact area, .000100-.000200 [0.00254-0.00508] tin on solder area, with entire post underplated .000050 [0.00127] nickel

**Plating B** — Duplex plated .000015 [0.00038] gold on contact area, .000100-.000200 [0.00254-0.00508] tin on solder area, with entire post underplated .000050 [0.00127] nickel

**Plating C** — .000100-.000200 [0.00254-0.00508] tin over .000050 [0.00127] nickel on entire post

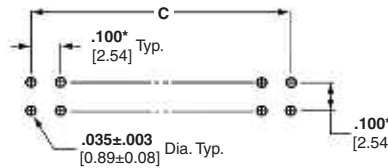
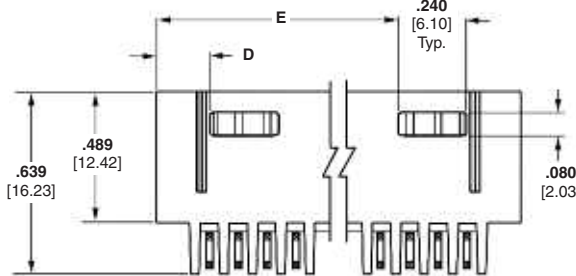

Recommended PC Board Hole Layout (for .055 [1.40] min. thick PC board)

\*±.003 [±0.08] tolerances not to accumulate within one connector pattern.

#### Related Product Data

##### Mateable Connectors

**AMPMODU MTE Receptacles** — pages 232, 233, 235 (used with coupling shroud on page 241)

**AMPMODU Wire-Applied Receptacles** — pages 216-219

#### Technical Documents — page 276

See mating connector for applicable product and application specifications.

No. of Pos.	Dimensions					Post Plating/Part Nos.		
	A	B	C	D	E	Plating A	Plating B	Plating C
8	.680 [17.27]	.600 [15.24]	.300 [7.62]	.190 [4.83]	—	5-103167-1	5-102570-2	5-87577-1
10	.780 [19.81]	.700 [17.78]	.400 [10.16]	.290 [7.37]	—	5-103167-2	5-102570-3	5-87577-2
12	.880 [22.35]	.800 [20.32]	.500 [12.70]	.290 [7.37]	—	5-103167-3	5-102570-4	5-87577-3
14	.980 [24.89]	.900 [22.86]	.600 [15.24]	.390 [9.91]	—	5-103167-4	5-102570-5	5-87577-4
16	1.080 [27.43]	1.000 [25.40]	.700 [17.78]	.390 [9.91]	—	5-103167-5	5-102570-6	5-87577-5
18	1.180 [29.97]	1.100 [27.94]	.800 [20.32]	.490 [12.45]	—	5-103167-6	5-102570-7	5-87577-6
20	1.280 [32.51]	1.200 [30.48]	.900 [22.86]	.190 [4.83]	.890 [22.61]	5-103167-7	5-102570-8	5-87577-7
22	1.380 [35.05]	1.300 [33.02]	1.000 [25.40]	.190 [4.83]	.990 [25.15]	5-103167-8	5-102570-9	5-87577-8
24	1.480 [37.59]	1.400 [35.56]	1.100 [27.94]	.190 [4.83]	1.090 [27.69]	5-103167-9	6-102570-0	5-87577-9
26	1.580 [40.13]	1.500 [38.10]	1.200 [30.48]	.190 [4.83]	1.190 [30.23]	6-103167-0	6-102570-1	6-87577-0
28	1.680 [42.67]	1.600 [40.64]	1.300 [33.02]	.190 [4.83]	1.290 [32.77]	6-103167-1	6-102570-2	6-87577-1
30	1.780 [45.21]	1.700 [43.18]	1.400 [35.56]	.190 [4.83]	1.390 [35.31]	6-103167-2	6-102570-3	6-87577-2

**Note:** All part numbers are RoHS compliant.

**Standard Profile Headers—Shrouded, with .150 [3.81] End Dimension, Double-Row, .100 x .100 [2.54 x 2.54] Centerline** (Continued)

No. of Pos.	Dimensions					Post Plating/Part Nos.		
	A	B	C	D	E	Plating A	Plating B	Plating C
32	1.880 [47.75]	1.800 [45.72]	1.500 [38.10]	.190 [4.83]	1.490 [37.85]	6-103167-3	6-102570-4	6-87577-3
34	1.980 [50.29]	1.900 [48.26]	1.600 [40.64]	.190 [4.83]	1.590 [40.39]	6-103167-4	6-102570-5	6-87577-4
36	2.080 [52.83]	2.000 [50.80]	1.700 [43.18]	.190 [4.83]	1.690 [42.93]	6-103167-5	6-102570-6	6-87577-5
38	2.180 [55.37]	2.100 [53.34]	1.800 [45.72]	.190 [4.83]	1.790 [45.47]	6-103167-6	6-102570-7	6-87577-6
40	2.280 [57.91]	2.200 [55.88]	1.900 [48.26]	.190 [4.83]	1.890 [48.01]	6-103167-7	5-102570-1	6-87577-7
42	2.380 [60.45]	2.300 [58.42]	2.000 [50.80]	.190 [4.83]	1.990 [50.55]	6-103167-8	6-102570-8	6-87577-8
44	2.480 [62.99]	2.400 [60.96]	2.100 [53.34]	.190 [4.83]	2.090 [53.09]	6-103167-9	6-102570-9	6-87577-9
46	2.580 [65.53]	2.500 [63.50]	2.200 [55.88]	.190 [4.83]	2.190 [55.63]	7-103167-0	7-102570-0	7-87577-0
48	2.680 [68.07]	2.600 [66.04]	2.300 [58.42]	.190 [4.83]	2.290 [58.17]	7-103167-1	7-102570-1	7-87577-1
50	2.780 [70.61]	2.700 [68.58]	2.400 [60.96]	.190 [4.83]	2.390 [60.71]	7-103167-2	7-102570-2	7-87577-2
52	2.880 [73.15]	2.800 [71.12]	2.500 [63.50]	.190 [4.83]	2.490 [63.25]	7-103167-3	7-102570-3	7-87577-3
54	2.980 [75.69]	2.900 [73.66]	2.600 [66.04]	.190 [4.83]	2.590 [65.79]	7-103167-4	7-102570-4	7-87577-4
56	3.080 [78.23]	3.000 [76.20]	2.700 [68.58]	.190 [4.83]	2.690 [68.33]	7-103167-5	7-102570-5	7-87577-5
58	3.180 [80.77]	3.100 [78.74]	2.800 [71.12]	.190 [4.83]	2.790 [70.87]	7-103167-6	7-102570-6	7-87577-6
60	3.280 [83.31]	3.200 [81.28]	2.900 [73.66]	.190 [4.83]	2.890 [73.41]	7-103167-7	7-102570-7	7-87577-7
62	3.380 [85.85]	3.300 [83.82]	3.000 [76.20]	.190 [4.83]	2.990 [75.95]	7-103167-8	7-102570-8	7-87577-8
64	3.480 [88.39]	3.400 [86.36]	3.100 [78.74]	.190 [4.83]	3.090 [78.49]	7-103167-9	7-102570-9	7-87577-9
66	3.580 [90.93]	3.500 [88.90]	3.200 [81.28]	.190 [4.83]	3.190 [81.03]	8-103167-0	8-102570-0	8-87577-0
68	3.680 [93.47]	3.600 [91.44]	3.300 [83.82]	.190 [4.83]	3.290 [83.57]	8-103167-1	8-102570-1	8-87577-1
70	3.780 [96.01]	3.700 [93.98]	3.400 [86.36]	.190 [4.83]	3.390 [86.11]	8-103167-2	8-102570-2	8-87577-2
72	3.880 [98.55]	3.800 [96.52]	3.500 [88.90]	.190 [4.83]	3.490 [88.65]	8-103167-3	8-102570-3	8-87577-3

Standard Profile Headers, Shrouded

5

**Note:** All part numbers are RoHS compliant.

## Standard Profile Headers—Shrouded, with .066 [1.68] End Dimension, Double-Row, .100 x .100 [2.54 x 2.54] Centerline

**.025 [0.64] Square Right-Angle Post (with Pin Protection on 3 Sides)**

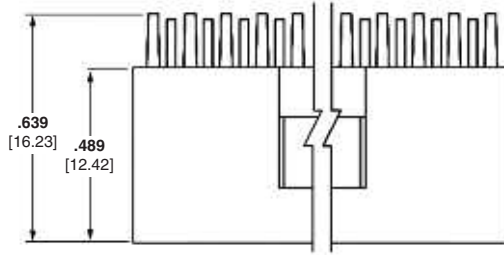

### Material and Finish

**Housing** — Black thermoplastic, 94V-0 rated

**Posts** — Phosphor bronze, plated as follows:

**Plating A** — Duplex plated .000030 [0.00076] gold on contact area, .000100-.000200 [0.00254-0.00508] tin on solder area, with entire post underplated .000050 [0.00127] nickel

**Plating B** — Duplex plated .000015 [0.00038] gold on contact area, .000100-.000200 [0.00254-0.00508] tin on solder area, with entire post underplated .000050 [0.00127] nickel

**Plating C** — .000100-.000200 [0.00254-0.00508] tin over .000050 [0.00127] nickel on entire post

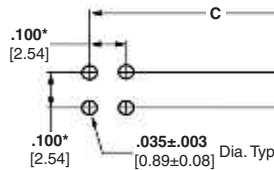
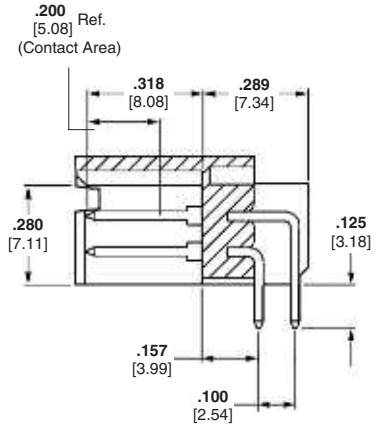
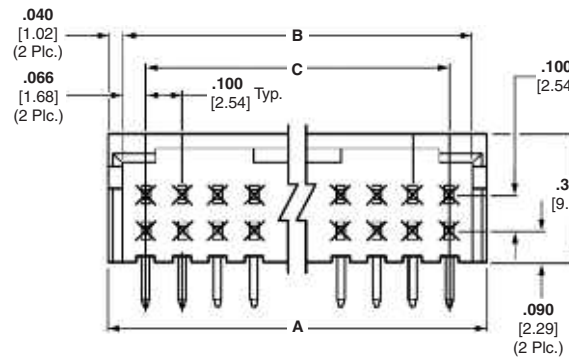

**Recommended PC Board Hole Layout (for .055 [1.40] min. thick PC board)**

\*±.003 [±0.08] tolerances not to accumulate within one connector pattern.

### Related Product Data

**Mateable Connectors**

**AMPMODU Board Mount**

**Receptacles** — pages 176, 179, 180

**AMPMODU Wire-Applied Receptacles** — pages 216, 217

**AMPMODU MTE Receptacles** — pages 228, 229, 234

**AMPMODU MT Receptacles** — pages 256, 257

**Technical Documents** — page 276

See mating connector for applicable product and application specifications.

No. of Pos.	Dimensions			Post Plating/Part Nos.		
	A	B	C	Plating A	Plating B	Plating C
6	.412 [10.46]	.332 [8.43]	.200 [5.08]	5-103164-1	5-102055-2	8-87572-5
8	.512 [13.00]	.432 [10.97]	.300 [7.62]	5-103164-2	5-102055-3	5-87572-1
10	.612 [15.54]	.532 [13.51]	.400 [10.16]	5-103164-3	5-102055-4	5-87572-2
12	.712 [18.08]	.632 [16.05]	.500 [12.70]	5-103164-4	5-102055-5	5-87572-3
14	.812 [20.62]	.732 [18.59]	.600 [15.24]	5-103164-5	5-102055-6	5-87572-4
16	.912 [23.16]	.832 [21.13]	.700 [17.78]	5-103164-6	5-102055-7	5-87572-5
18	1.012 [25.70]	.932 [23.67]	.800 [20.32]	5-103164-7	5-102055-8	5-87572-6
20	1.112 [28.24]	1.032 [26.21]	.900 [22.86]	5-103164-8	5-102055-1	5-87572-7
24	1.312 [33.32]	1.232 [31.29]	1.100 [27.94]	6-103164-0	6-102055-0	—
26	1.412 [35.86]	1.332 [33.83]	1.200 [30.48]	6-103164-1	—	6-87572-0
30	1.612 [40.94]	1.532 [38.91]	1.400 [35.56]	6-103164-3	6-102055-3	—
34	1.812 [46.02]	1.732 [43.99]	1.600 [40.64]	6-103164-5	6-102055-5	6-87572-4
40	2.112 [53.64]	2.032 [51.61]	1.900 [48.26]	6-103164-8	6-102055-8	6-87572-7
50	2.612 [66.34]	2.532 [64.31]	2.400 [60.96]	7-103164-3	7-102055-3	7-87572-2
52	2.712 [68.88]	2.632 [66.85]	2.500 [63.50]	7-103164-4	—	—
54	2.812 [71.42]	2.732 [69.36]	2.600 [66.04]	—	7-102055-5	—
60	3.112 [79.04]	3.032 [77.01]	2.900 [73.66]	7-103164-8	7-102055-8	7-87572-7

**Note:** All part numbers are RoHS compliant.

## Standard Profile Headers—Shrouded, with .150 [3.81] End Dimension, Double-Row, .100 x .100 [2.54 x 2.54] Centerline

### .025 [0.64] Square Right-Angle Post (with Pin Protection on 3 Sides)

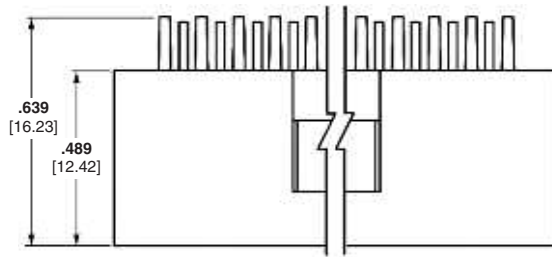

#### Material and Finish

**Housing** — Black thermoplastic, 94V-0 rated

**Posts** — Phosphor bronze, plated as follows:

**Plating A** — Duplex plated .000030 [0.00076] gold on contact area, .000100-.000200 [0.00254-0.00508] tin on solder area, with entire post underplated .000050 [0.00127] nickel

**Plating B** — Duplex plated .000015 [0.00038] gold on contact area, .000100-.000200 [0.00254-0.00508] tin on solder area, with entire post underplated .000050 [0.00127] nickel

**Plating C** — .000100-.000200 [0.00254-0.00508] tin over .000050 [0.00127] nickel on entire post

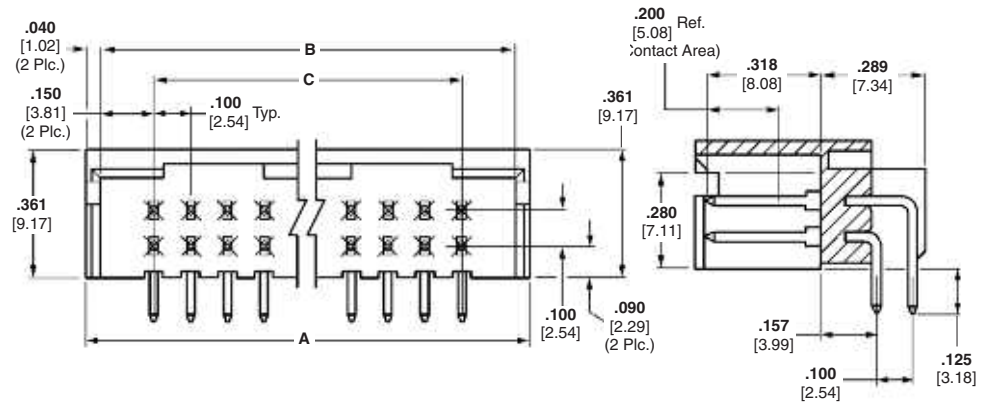

#### Related Product Data

**Mateable Connectors**

**AMPMODU Wire-Applied Receptacles** — pages 216, 217

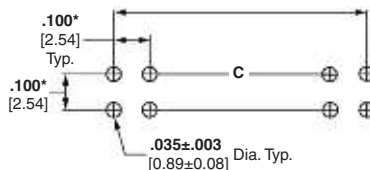

**Recommended PC Board Hole Layout (for .055 [1.40] min. thick PC board)**

\*±.003 [±0.08] tolerances not to accumulate within one connector pattern.

#### Technical Documents — page 276

See mating connector for applicable product and application specifications.

No. of Pos.	Dimensions			Post Plating/Part Nos.		
	A	B	C	Plating A	Plating B	Plating C
10	.780 [19.81]	.700 [17.78]	.400 [10.16]	5-103165-1	5-102620-1	5-87568-1
12	.880 [22.35]	.800 [20.32]	.500 [12.70]	5-103165-2	5-102620-2	5-87568-2
14	.980 [24.89]	.900 [22.86]	.600 [15.24]	5-103165-3	5-102620-3	5-87568-3
16	1.080 [27.43]	1.000 [25.40]	.700 [17.78]	5-103165-4	5-102620-4	5-87568-4
18	1.180 [29.97]	1.100 [27.94]	.800 [20.32]	5-103165-5	5-102620-5	5-87568-5
20	1.280 [32.51]	1.200 [30.48]	.900 [22.86]	5-103165-6	5-102620-6	5-87568-6
24	1.480 [37.59]	1.400 [35.56]	1.100 [27.94]	5-103165-8	5-102620-8	—
26	1.580 [40.13]	1.500 [38.10]	1.200 [30.48]	5-103165-9	5-102620-9	5-87568-9
30	1.780 [45.21]	1.700 [43.18]	1.400 [35.56]	6-103165-1	6-102620-1	—
34	1.980 [50.29]	1.900 [48.26]	1.600 [40.64]	6-103165-3	6-102620-3	6-87568-3
40	2.280 [57.91]	2.200 [55.88]	1.900 [48.26]	6-103165-6	6-102620-6	6-87568-6
50	2.780 [70.61]	2.700 [68.58]	2.400 [60.96]	7-103165-1	7-102620-1	7-87568-1
60	3.280 [83.31]	3.200 [81.28]	2.900 [73.66]	7-103165-6	7-102620-6	7-87568-6

**Note:** All part numbers are RoHS compliant.

## Standard Profile Headers—Shrouded, with .150 [3.81] End Dimension, Double-Row, .100 x .100 [2.54 x 2.54] Centerline

### .025 [0.64] Square Right-Angle Post (with Plastic Holddowns)



#### Material and Finish

**Housing** — Black thermoplastic, 94V-0 rated

**Posts** — Phosphor bronze, duplex plated .000015 [0.00038] gold on contact area, .000100-.000200 [0.00254-0.00508] tin on solder area, with entire post underplated .000050 [0.00127] nickel

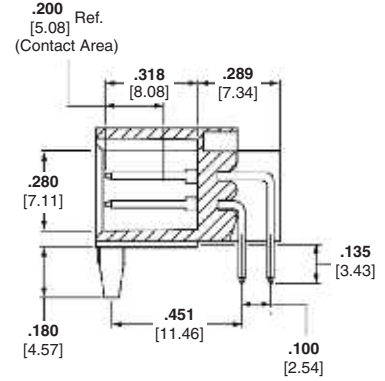
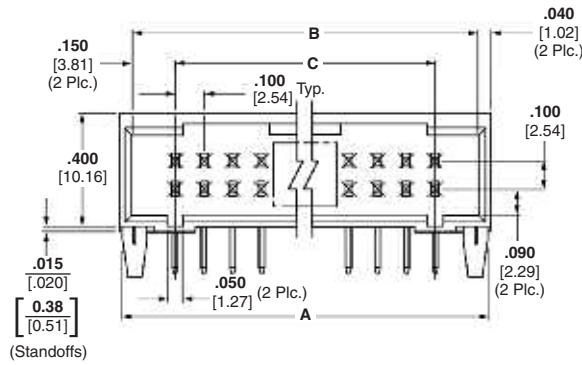
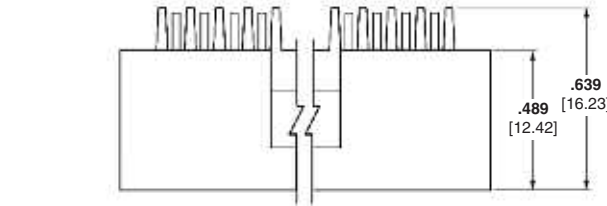

#### Related Product Data

##### Mateable Connectors

**AMPMODU MTE Receptacles** — pages 232, 233, 235 (used with coupling shroud on page 241)

**AMPMODU Wire-Applied Receptacles** — pages 216-219

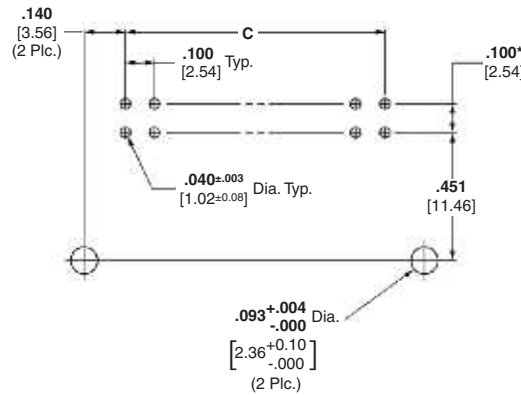

**Recommended PC Board Hole Layout (for .055 [1.40] min. thick PC board)**

\*±.003 [±0.08] tolerances not to accumulate within one connector pattern.

#### Technical Documents — page 276

See mating connector for applicable product and application specifications.

No. of Pos.	Dimensions			Part Nos.
	A	B	C	
10	.780 [19.81]	.700 [17.78]	.400 [10.16]	5-104319-7
12	.880 [22.35]	.800 [20.32]	.500 [12.70]	5-104319-8
14	.980 [24.89]	.900 [22.86]	.600 [15.24]	5-104319-5
16	1.080 [27.43]	1.000 [25.40]	.700 [17.78]	5-104319-1
20	1.280 [32.51]	1.200 [30.48]	.900 [20.86]	5-104319-2
30	1.780 [45.21]	1.700 [43.18]	1.400 [35.56]	5-104319-3
34	1.980 [50.29]	1.900 [48.26]	1.600 [40.64]	5-104319-6
40	2.280 [57.91]	2.200 [55.88]	1.900 [48.26]	5-104319-4
48	2.680 [68.07]	2.600 [66.04]	2.300 [58.42]	5-104319-9

**Note:** All part numbers are RoHS compliant.



**Standard Profile Headers—Shrouded, with .150 [3.81] End Dimension, Double-Row, .100 x .100 [2.54 x 2.54] Centerline** (Continued)

**.025 [0.64] Square Straight Post (with Detent Windows and Mounting Ears)**



**Material and Finish**

**Housing** — Black thermoplastic, 94V-0 rated

**Posts** — Copper alloy, plated .000030 [0.00076] gold over .000050 [0.00127] nickel on entire post

**Related Product Data**

**Mateable Connectors**

**AMPMODU Wire-Applied Receptacles** — pages 216-219

**AMPMODU MTE Receptacles** — pages 232, 233, 235 (used with coupling shroud on page 241)

**Accessories**

**Barrier Insert** — page 204

**Technical Documents** — page 276

See mating connector for applicable product and application specifications.

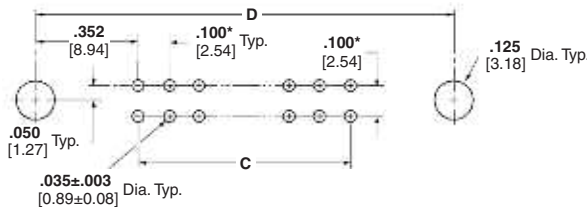
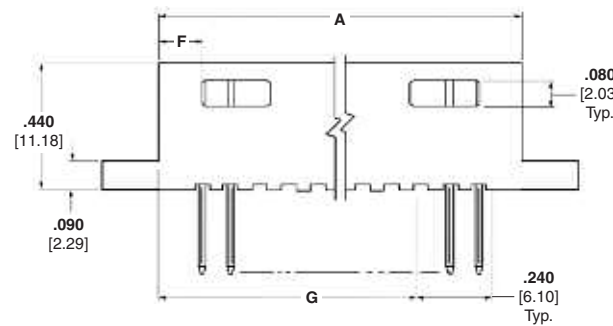
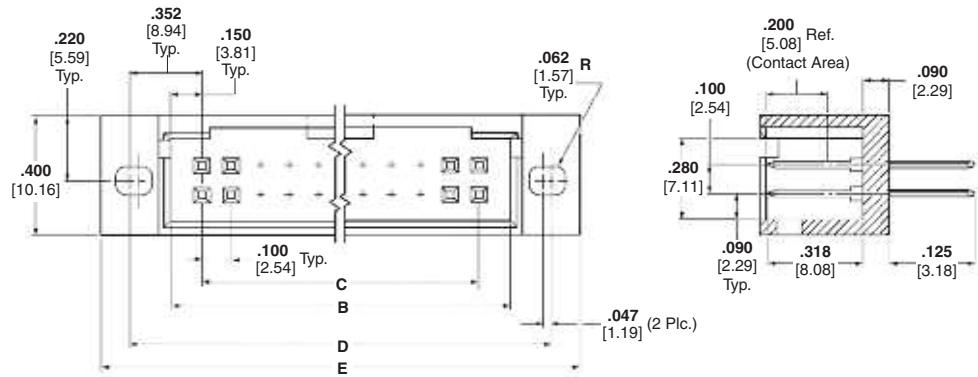

**Recommended PC Board Hole Layout**  
(for .055 [1.40] min. thick PC board)

\*±.003 [±0.08] tolerances not to accumulate within one connector pattern.

No. of Pos.	Dimensions							Part Nos.
	A	B	C	D	E	F	G	
10	.780 [19.81]	.700 [17.78]	.400 [10.16]	1.104 [28.04]	1.304 [33.12]	.290 [7.37]	—	87474-1
14	.980 [24.89]	.900 [22.86]	.600 [15.24]	1.304 [33.12]	1.504 [38.20]	.190 [4.83]	—	87474-9
20	1.280 [32.51]	1.200 [30.48]	.900 [22.86]	1.604 [40.74]	1.804 [45.82]	.190 [4.83]	.890 [22.61]	87474-2
24	1.480 [37.59]	1.400 [35.56]	1.100 [27.94]	1.804 [45.82]	2.004 [50.90]	.190 [4.83]	1.090 [27.69]	1-87474-3
26	1.580 [40.13]	1.500 [38.10]	1.200 [30.48]	1.904 [48.36]	2.104 [53.44]	.190 [4.83]	1.190 [30.23]	87474-3
34	1.980 [50.29]	1.900 [48.26]	1.600 [40.64]	2.304 [58.52]	2.504 [63.60]	.190 [4.83]	1.590 [40.39]	87474-4
40	2.280 [57.91]	2.200 [55.88]	1.900 [48.26]	2.604 [66.14]	2.804 [71.22]	.190 [4.83]	1.890 [48.01]	87474-6
50	2.780 [70.61]	2.700 [68.58]	2.400 [60.96]	3.104 [78.84]	3.304 [83.92]	.190 [4.83]	2.390 [60.71]	87474-7
60	3.280 [83.31]	3.200 [81.28]	2.900 [73.66]	3.604 [91.54]	3.804 [96.62]	.190 [4.83]	2.890 [73.41]	2-87474-6

**Note:** All part numbers are RoHS compliant.

## Standard Profile Headers—Shrouded Bulkhead Type; with .066 [1.68] End Dimension, Double-Row, .100 x .100 [2.54 x 2.45] Centerline

**.025 [0.64] Square Straight Post (with Detent Windows and Mounting Ears)**

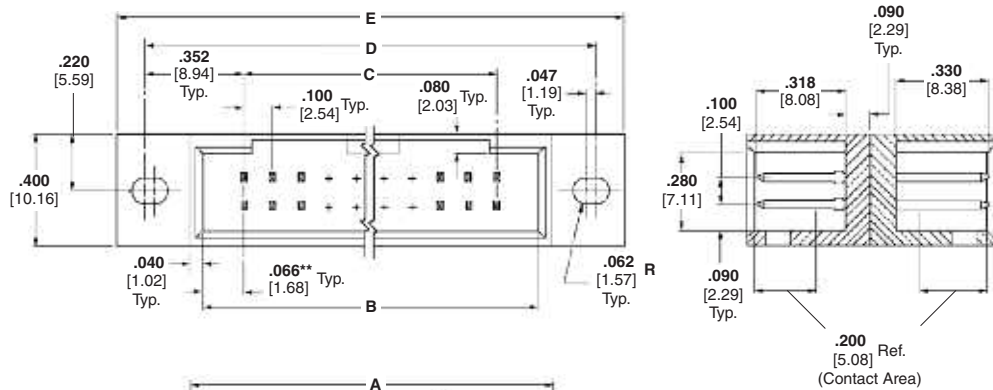

**Material and Finish**

**Housing** — Black thermoplastic, 94V-0 rated  
**Posts** — Copper alloy, plated .000030 [0.00076] gold over .000050 [0.00127] nickel on entire post

**Related Product Data**

- Mateable Connectors**
- AMPMODU Board Mount Receptacles** — pages 176, 179, 180
- AMPMODU Wire-Applied Receptacles** — pages 216-219
- AMPMODU MTE Receptacles** — pages 228, 229, 234
- AMPMODU MT Receptacles** — pages 256, 257

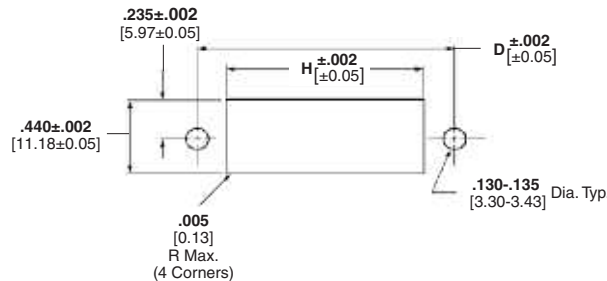
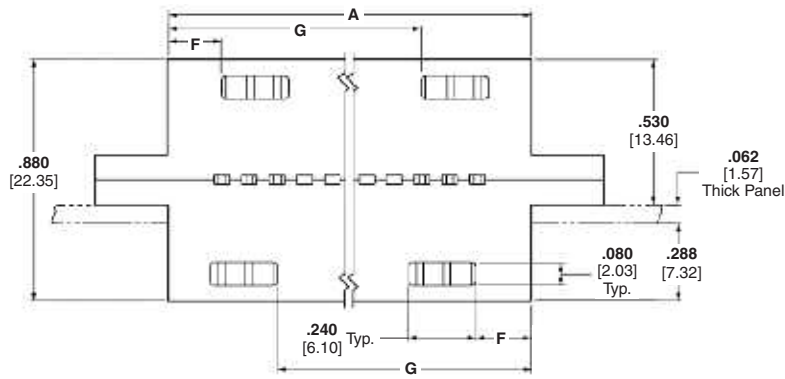

**Recommended Panel Cutout**

\*\*Both mating faces have same end dimension.

No. of Pos.	Dimensions								Part Nos.
	A	B	C	D	E	F	G	H	
10	.612 [15.54]	.532 [13.51]	.400 [10.16]	1.104 [28.04]	1.304 [33.12]	.206 [5.23]	—	.632 [16.05]	87608-1
12	.712 [18.08]	.632 [16.05]	.500 [12.70]	1.204 [30.58]	1.404 [35.66]	.206 [5.23]	—	.732 [18.59]	87608-2
20	1.112 [28.24]	1.032 [26.21]	.900 [22.86]	1.604 [40.74]	1.804 [45.82]	.106 [2.69]	.806 [20.47]	1.132 [28.75]	87608-6
24	1.312 [33.32]	1.232 [31.29]	1.100 [27.94]	1.804 [45.82]	2.004 [50.90]	.106 [2.69]	1.006 [25.55]	1.332 [33.83]	87608-8
26	1.412 [35.86]	1.332 [33.83]	1.200 [30.48]	1.904 [48.36]	2.104 [53.44]	.106 [2.69]	1.106 [28.09]	1.432 [36.37]	87608-9
34	1.812 [46.02]	1.732 [43.99]	1.600 [40.64]	2.304 [58.52]	2.504 [63.60]	.106 [2.69]	1.506 [38.25]	1.832 [46.53]	1-87608-3
40	2.112 [53.64]	2.032 [51.61]	1.900 [48.26]	2.604 [66.14]	2.804 [71.22]	.106 [2.69]	1.806 [45.87]	2.132 [54.15]	1-87608-6
50	2.612 [66.34]	2.532 [64.31]	2.400 [60.96]	3.104 [78.84]	3.304 [83.92]	.106 [2.69]	2.306 [58.57]	2.632 [66.85]	2-87608-1
60	3.112 [79.04]	3.032 [77.01]	2.900 [73.66]	3.604 [91.54]	3.804 [96.62]	.106 [2.69]	2.806 [71.27]	3.132 [79.55]	2-87608-6

**Note:** All part numbers are RoHS compliant.

Standard Profile Headers, Shrouded

5

### Standard Profile Headers—Shrouded Bulkhead Type; with .150 [3.81] End Dimension, Double-Row, .100 x .100 [2.54 x 2.45] Centerline

**.025 [0.64] Square Straight Post (with Detent Windows and Mounting Ears)**

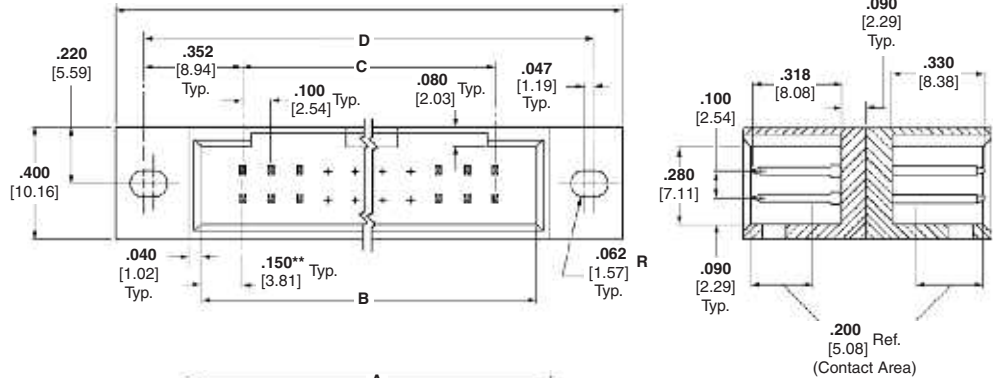

**Material and Finish**

**Housing** — Black thermoplastic, 94V-0 rated

**Posts** — Copper alloy, plated .000030 [0.00076] gold over .000050 [0.00127] nickel on entire post

**Related Product Data**

**Mateable Connectors**

**AMPMODU MTE Receptacles** — pages 232, 233, 235 (used with coupling shroud on page 241)

**AMPMODU Wire-Applied Receptacles** — pages 216-219

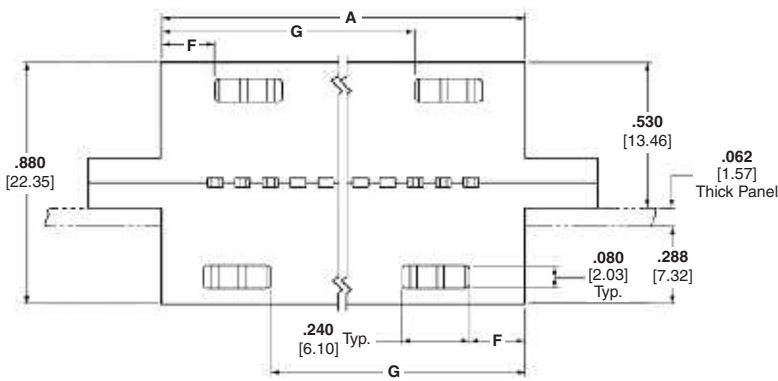

**Accessories**

**Barrier Insert** — page 204

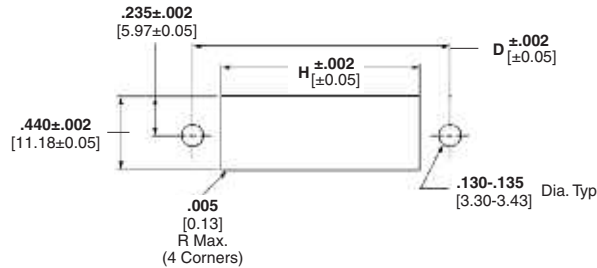

**Technical Documents** — page 276

See mating connector for applicable product and application specifications.

**Recommended Panel Cutout**

\*\*Both mating faces have same end dimension.

No. of Pos.	Dimensions								Part Nos.
	A	B	C	D	E	F	G	H	
10	.780 [19.81]	.700 [17.78]	.400 [10.16]	1.104 [28.04]	1.304 [33.12]	.290 [7.37]	—	.800 [20.32]	87605-1
20	1.280 [32.51]	1.200 [30.48]	.900 [22.86]	1.604 [40.74]	1.804 [45.82]	.190 [4.83]	.890 [22.61]	1.300 [33.02]	87605-6
24	1.480 [37.59]	1.400 [35.56]	1.100 [27.94]	1.804 [45.82]	2.004 [50.90]	.190 [4.83]	1.090 [27.69]	1.500 [38.10]	87605-8
26	1.580 [40.13]	1.500 [38.10]	1.200 [30.48]	1.904 [48.36]	2.104 [53.44]	.190 [4.83]	1.190 [30.23]	1.600 [40.64]	87605-9
30	1.780 [45.21]	1.700 [43.18]	1.400 [35.56]	2.104 [53.44]	2.304 [58.52]	.190 [4.83]	1.390 [35.31]	1.800 [45.72]	1-87605-1
32	1.880 [47.75]	1.800 [45.72]	1.500 [38.10]	2.204 [55.98]	2.404 [61.06]	.190 [4.83]	1.490 [37.85]	1.900 [48.26]	1-87605-2
34	1.980 [50.29]	1.900 [48.26]	1.600 [40.64]	2.304 [58.52]	2.504 [63.60]	.190 [4.83]	1.590 [40.39]	2.000 [50.80]	1-87605-3
40	2.280 [57.91]	2.200 [55.88]	1.900 [48.26]	2.604 [66.14]	2.804 [71.22]	.190 [4.83]	1.890 [48.01]	2.300 [58.42]	1-87605-6
50	2.780 [70.61]	2.700 [68.58]	2.400 [60.96]	3.104 [78.84]	3.304 [83.92]	.190 [4.83]	2.390 [60.71]	2.800 [71.12]	2-87605-1
60	3.280 [83.31]	3.200 [81.28]	2.900 [73.66]	3.604 [91.54]	3.804 [96.62]	.190 [4.83]	2.890 [73.41]	3.300 [83.82]	2-87605-6

**Note:** All part numbers are RoHS compliant.

**Standard Profile Headers—Shrouded Bulkhead Type; with .066/.150 [1.68/3.81] End Dimension, Double-Row, .100 x .100 [2.54 x 2.45] Centerline**

**.025 [0.64] Square Straight Post (with Detent Windows and Mounting Ears)**

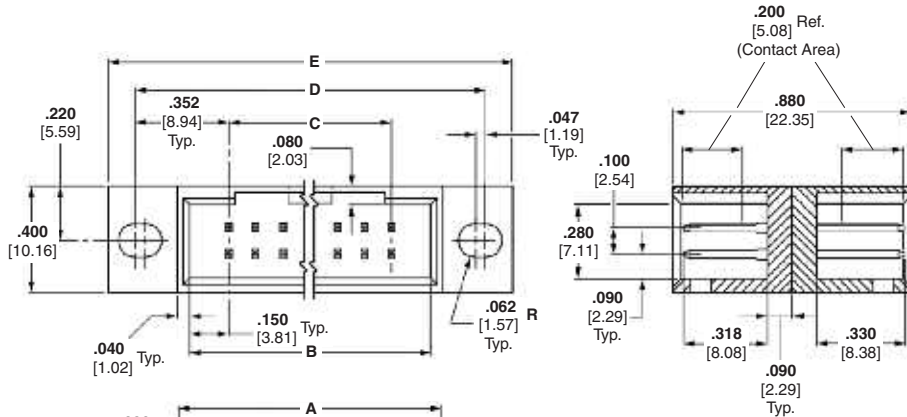

**Material and Finish**

**Housing** — Black thermoplastic, 94V-0 rated

**Posts** — Copper alloy, plated .000030 [0.00076] gold over .000050 [0.00127] nickel on entire post

**Related Product Data**

- Mateable Connectors with .066 [1.68] End Dimension** — AMPMODU Board Mount Receptacles — pages 176, 179, 180
- AMPMODU Wire-Applied Receptacles** — pages 216-219
- AMPMODU MTE Receptacles** — pages 228, 229, 234
- AMPMODU MT Receptacles** — pages 256, 257

- Mateable Connectors with .150 [3.81] End Dimension** — AMPMODU MTE Receptacles — pages 232, 233, 235 (used with coupling shroud on page 241)

**Accessories**

**Barrier Insert** — page 204

**Technical Documents** — page 276

See mating connector for applicable product and application specifications.

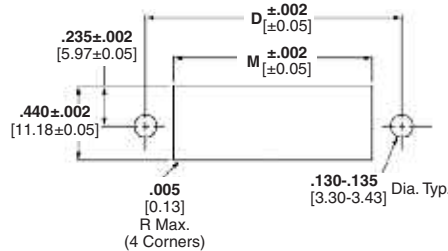
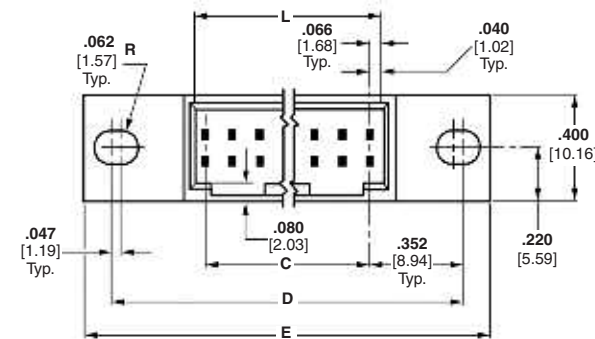
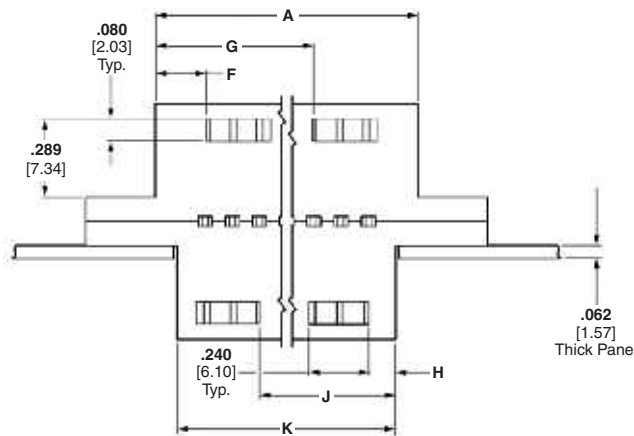

**Recommended Panel Cutout**

Standard Profile Headers, Shrouded

5

**Standard Profile Headers—Shrouded Bulkhead Type; with .066/.150 [1.68/3.81] End Dimension, Double-Row, .100 x .100 [2.54 x 2.45] Centerline** (Continued)

No. of Pos.	Dimensions						Part Nos.
	A	B	C	D	E	F	
10	.780 [19.81]	.700 [17.78]	.400 [10.16]	1.104 [28.04]	1.304 [33.12]	.290 [7.37]	87496-2
20	1.280 [32.51]	1.200 [30.48]	.900 [22.86]	1.604 [40.74]	1.804 [45.82]	.190 [4.83]	87496-7
24	1.480 [37.59]	1.400 [35.56]	1.100 [27.94]	1.804 [45.82]	2.004 [50.90]	.190 [4.83]	87496-9
26	1.580 [40.13]	1.500 [38.10]	1.200 [30.48]	1.904 [48.36]	2.104 [53.44]	.190 [4.83]	1-87496-0
30	1.780 [45.21]	1.700 [43.18]	1.400 [35.56]	2.104 [53.44]	2.304 [58.52]	.190 [4.83]	1-87496-2
34	1.980 [50.29]	1.900 [48.26]	1.600 [40.64]	2.304 [58.52]	2.504 [63.60]	.190 [4.83]	1-87496-4
40	2.280 [57.91]	2.200 [55.88]	1.900 [48.26]	2.604 [66.14]	2.804 [71.22]	.190 [4.83]	1-87496-7
50	2.780 [70.61]	2.700 [68.58]	2.400 [60.96]	3.304 [83.92]	3.304 [83.92]	.190 [4.83]	87496-1
60	3.280 [83.31]	3.200 [81.38]	2.900 [73.66]	3.604 [91.54]	3.804 [96.62]	.190 [4.83]	2-87496-6

No. of Pos.	Dimensions						Part Nos.
	G	H	J	K	L	M	
10	—	.206 [5.23]	—	.612 [15.54]	.532 [13.51]	.632 [16.05]	87496-2
20	.890 [22.61]	.106 [2.69]	.806 [20.47]	1.112 [28.24]	1.032 [26.21]	1.132 [28.75]	87496-7
24	1.090 [27.69]	.106 [2.69]	1.006 [25.55]	1.312 [33.32]	1.232 [31.29]	1.332 [33.83]	87496-9
26	1.190 [30.23]	.106 [2.69]	1.106 [28.09]	1.412 [35.86]	1.332 [33.83]	1.432 [36.37]	1-87496-0
30	1.390 [35.31]	.106 [2.69]	1.306 [33.17]	1.612 [40.94]	1.532 [38.91]	1.632 [41.45]	1-87496-2
34	1.590 [40.39]	.106 [2.69]	1.506 [38.25]	1.812 [46.02]	1.732 [43.99]	1.832 [46.53]	1-87496-4
40	1.890 [48.01]	.106 [2.69]	1.806 [45.87]	2.112 [53.64]	2.032 [51.61]	2.132 [54.15]	1-87496-7
50	2.390 [60.71]	.106 [2.69]	2.306 [58.57]	2.612 [66.34]	2.532 [64.31]	2.632 [66.85]	87496-1
60	2.890 [73.41]	.106 [2.69]	2.806 [71.27]	3.112 [79.04]	3.032 [77.01]	3.132 [79.55]	2-87496-6



Standard Profile Headers, Shrouded

5

**Note:** All part numbers are RoHS compliant.

## AMP-LATCH Low Profile Headers—Shrouded

### Product Facts

- Available in selected positions 10 thru 60
- Flame retardant, thermoplastic housings, 94V-0 rated
- Vertical and right-angle versions available in double row configurations
- Available in .025 [0.64] square drawn wire posts
- Wash out clearance for flux removal
- Mates with AMP-LATCH Ribbon Cable Connectors
- Available with and without eject latches
- Available with and without kinked soldertails for PCB retention
- Recognized under the Component Program of Underwriters Laboratories Inc.  File No. E28476
- Certified by Canadian Standards Association,  File No. LR 7189

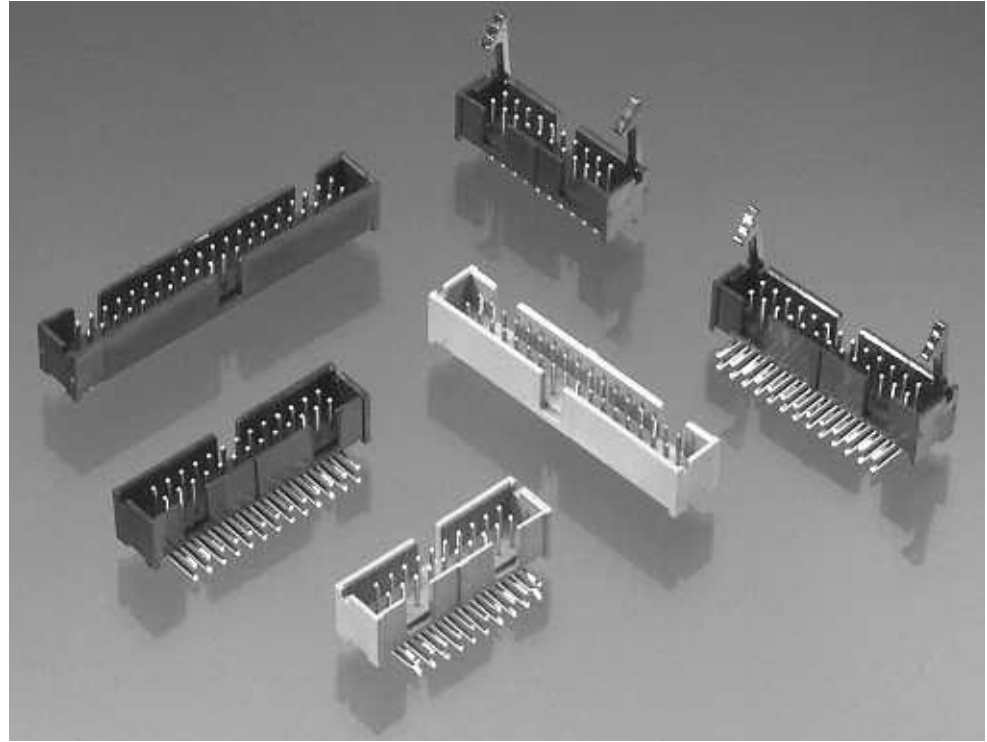

### Performance Characteristics

#### Electrical

**Insulation Resistance** — 5,000 megohms minimum initial

**Dielectric Withstanding Voltage** — 1,000 V rms at sea level

#### Environmental

**Operating Temperature** — -65°C to +105°C

**Current** — 1 ampere maximum per contact

## AMP-LATCH Low Profile Headers—Shrouded, with .150 [3.81] End Dimension, Double-Row, .100 x .100 [2.54 x 2.54] Centerline

**.025 [0.64] Square Straight Post**

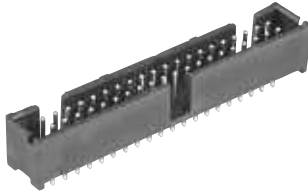

### Material and Finish

**Housing** — Glass-filled nylon, black, 94V-0 rated

**Posts** — Copper alloy, plated as follows:

**Plating A** — Gold flash over .000030 [0.00076] min. palladium-nickel plate on the mating surfaces, .000100 [0.00254] min. tin plate on soldertails, with entire post underplated .000050 [0.00127] min. nickel

**Plating B** — Gold flash over .000015 [0.00038] min. palladium-nickel plate on the mating surfaces, .000100 [0.00254] min. tin plate on soldertails, with entire post underplated .000050 [0.00127] min. nickel

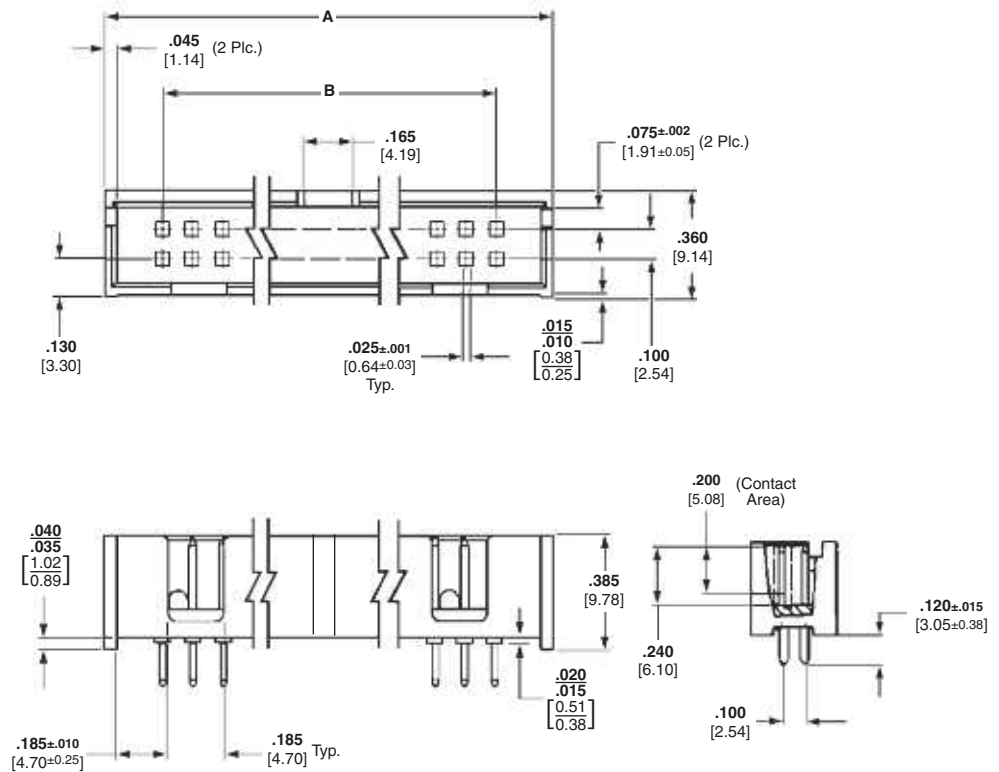

### Related Product Data

**Electrical Characteristics** — page 134

**Mateable Connectors** —

**AMPMODU Wire-Applied Receptacles** — page 220

**AMPMODU Board Mount Receptacles** — pages 179, 180

**Short Point Wire-Applied Connectors** — page 224

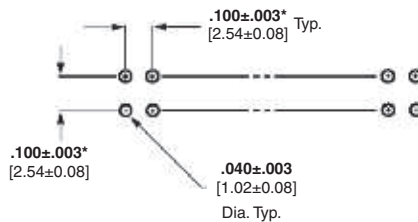

### Recommended PC Board Hole Layout For Manual Insertion

\*±.003 [±0.08] tolerances not to accumulate within one connector pattern.

No. of Pos.	Dimensions		Post Plating/Part Nos.	
	A	B	Plating A	Plating B
10	.800 [20.32]	.400 [10.16]	5103309-1	5103308-1
14	1.000 [25.40]	.600 [15.24]	5103309-2	5103308-2
16	1.100 [27.94]	.700 [17.78]	5103309-3	5103308-3
20	1.300 [33.02]	.900 [22.86]	5103309-5	5103308-5
24	1.400 [35.56]	1.100 [27.94]	—	1-5103308-3
26	1.600 [40.64]	1.200 [30.48]	5103309-6	5103308-6
34	2.000 [50.80]	1.600 [40.64]	5103309-7	5103308-7
40	2.300 [58.42]	1.900 [48.26]	5103309-8	5103308-8
50	2.800 [71.12]	2.400 [60.96]	1-5103309-0	1-5103308-0
60	3.300 [83.82]	2.900 [73.66]	—	1-5103308-2

**Note:** All part numbers are RoHS compliant.

## AMP-LATCH Low Profile Headers—Shrouded, with .150 [3.81] End Dimension, Double-Row, .100 x .100 [2.54 x 2.54] Centerline (Continued)

### .025 [0.64] Square Right-Angle Post

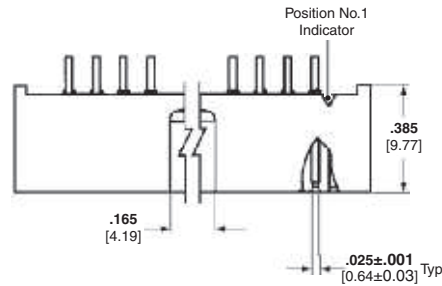
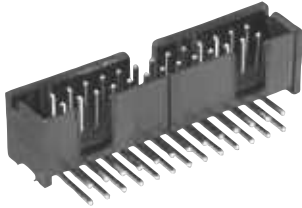

#### Material and Finish

**Housing** — Glass-filled nylon, black, 94V-0 rated

**Posts** — Copper alloy, plated as follows:

**Plating A** — Gold flash over .000030 [0.00076] min. palladium-nickel plate on the mating surfaces, .000100 [0.00254] min. tin plate on soldertails, with entire post underplated .000050 [0.00127] min. nickel

**Plating B** — Gold flash over .000015 [0.00038] min. palladium-nickel plate on the mating surfaces, .000100 [0.00254] min. tin plate on soldertails, with entire post underplated .000050 [0.00127] min. nickel

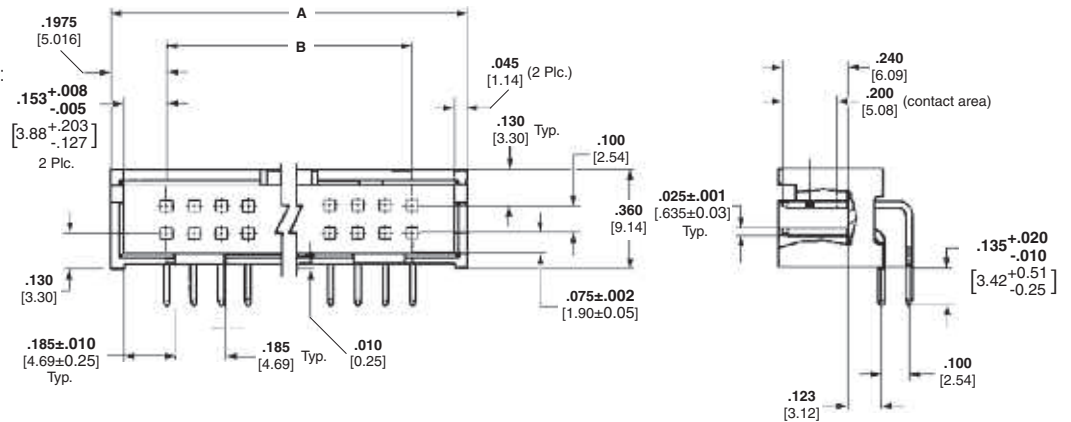

#### Related Product Data

**Electrical Characteristics** — page 134

**Mateable Connectors** — AMPMODU Wire-Applied Receptacles — page 220

**Short Point Wire-Applied Connectors** — page 224

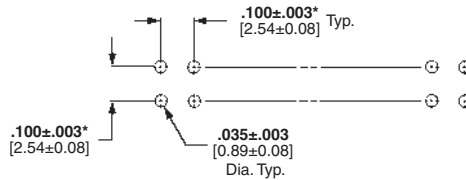

#### Recommended PC Board Hole Layout For Manual Insertion

\*±.003 [±0.08] tolerances not to accumulate within one connector pattern.

No. of Pos.	Dimensions		Post Plating/Part Nos.	
	A	B	Plating A	Plating B
10	.800 [20.32]	.400 [10.16]	5103311-1	5103310-1
14	1.000 [25.40]	.600 [15.24]	5103311-2	5103310-2
16	1.100 [27.94]	.700 [17.78]	5103311-3	5103310-3
20	1.300 [33.02]	.900 [22.86]	5103311-5	5103310-5
26	1.600 [40.64]	1.200 [30.48]	5103311-6	5103310-6
34	2.000 [50.80]	1.600 [40.64]	5103311-7	5103310-7
40	2.300 [58.42]	1.900 [48.26]	5103311-8	5103310-8
50	2.800 [71.12]	2.400 [60.96]	1-5103311-0	1-5103310-0
60	3.300 [83.82]	2.900 [73.66]	1-5103311-2	—

**Note:** All part numbers are RoHS compliant.



## AMP-LATCH Low Profile Headers—Shrouded, with .150 [3.81] End Dimension, Double-Row, .100 x .100 [2.54 x 2.54] Centerline & “Kinked” Solderetails for PCB Retention

### .025 [0.64] Square Straight Post (with Board Retention Feature)

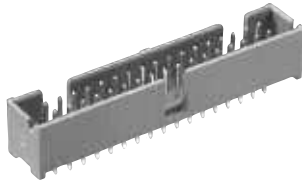

#### Material and Finish

**Housing** — Glass-filled PPA, black, 94V-0 rated

**Posts** — Copper alloy, plated with gold flash over .000015 [0.00038] min. palladium-nickel plate on the mating surfaces, .000100 [0.00254] min. tin plate on solderetails, with entire post underplated .000050 [0.00127] min. nickel

#### Related Product Data

**Electrical Characteristics** — page 134

**Mateable Connectors** —

**AMPMODU Wire-Applied Receptacles** — page 220

**AMPMODU Board Mount Receptacles** — pages 179, 180

**Short Point Wire-Applied Connectors** — page 224

\*Reflow solder process compatible

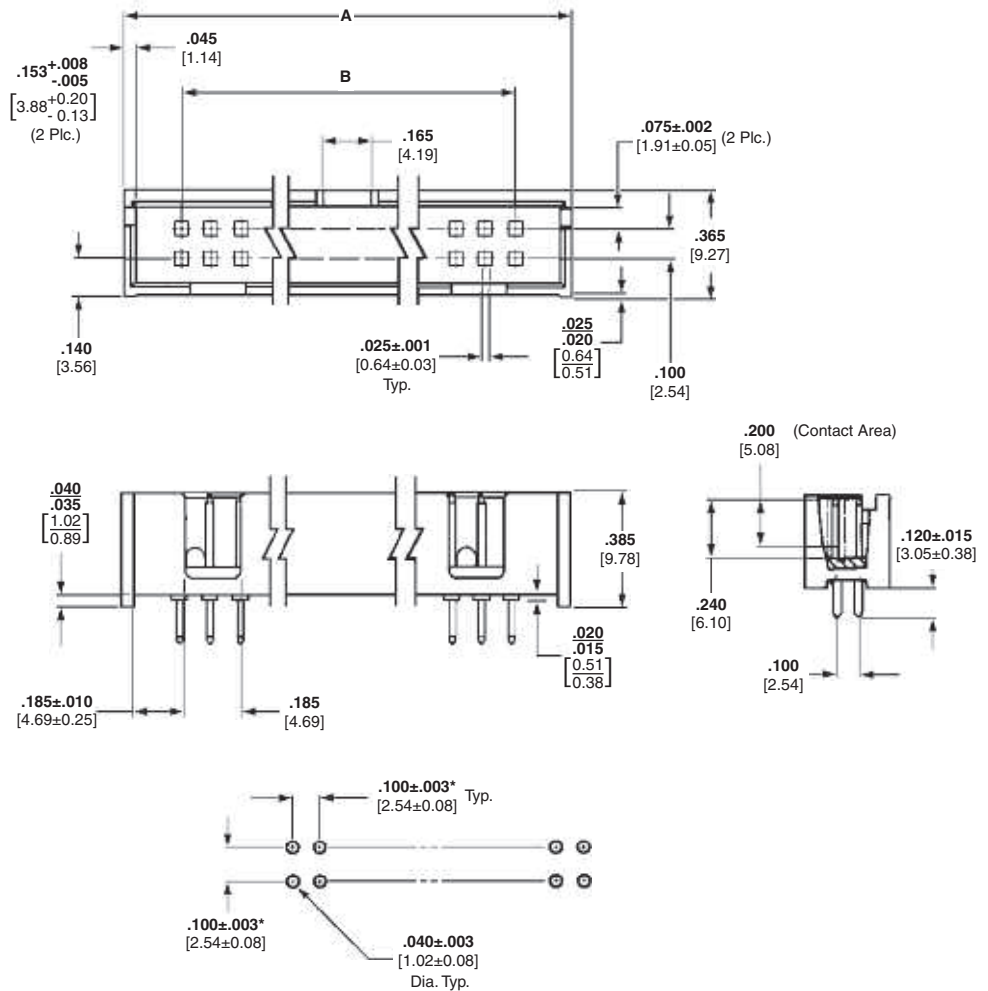

#### Recommended PC Board Hole Layout For Manual Insertion

\*±.003 [±0.08] tolerances not to accumulate within one connector pattern.

No. of Pos.	Dimensions		Post Plating Part Nos.
	A	B	
10	.800 [20.32]	.400 [10.16]	5104338-1
14	1.000 [25.40]	.600 [15.24]	5104338-2
16	1.100 [27.94]	.700 [17.78]	5104338-3
20	1.300 [33.02]	.900 [22.86]	5104338-4
24	1.400 [35.56]	1.100 [27.94]	5104338-5
34	2.000 [50.80]	1.600 [40.64]	5104338-7
40	2.300 [58.42]	1.900 [48.26]	5104338-8
50	2.800 [71.12]	2.400 [60.96]	5104338-9
60	3.300 [83.82]	2.900 [73.66]	1-5104338-0

**Note:** All part numbers are RoHS compliant.

**AMP-LATCH Low Profile Headers—Shrouded, with .150 [3.81] End Dimension, Double-Row, .100 x .100 [2.54 x 2.54] Centerline & “Kinked” Solderetails for PCB Retention** (Continued)

**.025 [0.64] Square Right-Angle Post (with Board Retention Feature)**

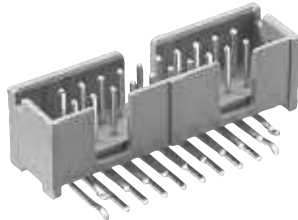

**Material and Finish**

**Housing** — Glass-filled PPA, black, 94V-0 rated

**Posts** — Copper alloy, plated with gold flash over .000015 [0.00038] min. palladium-nickel plate on the mating surfaces, .000100 [0.00254] min. tin plate on solderetails, with entire post underplated .000050 [0.00127] min. nickel

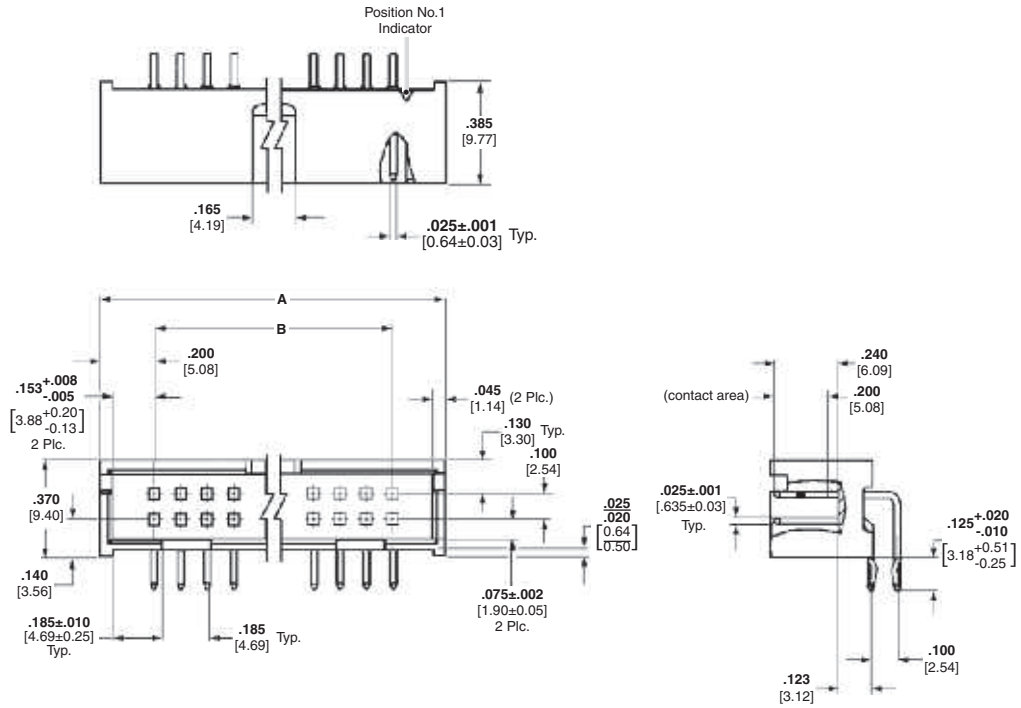

**Related Product Data**

**Electrical Characteristics** — page 134

**Mateable Connectors** —

**AMPMODU Wire-Applied Receptacles** — page 220

**Short Point Wire-Applied Connectors** — page 224

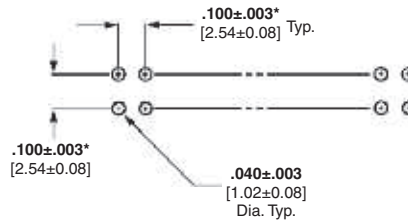

**Recommended PC Board Hole Layout For Manual Insertion**

\*±.003 [±0.08] tolerances not to accumulate within one connector pattern.

No. of Pos.	Dimensions		Post Plating Part Nos.
	A	B	
10	.800 [20.32]	.400 [10.16]	5104340-1
14	1.000 [25.40]	.600 [15.24]	5104340-2
16	1.100 [27.94]	.700 [17.78]	5104340-3
20	1.300 [33.02]	.900 [22.86]	5104340-4
40	2.300 [58.42]	1.900 [48.26]	5104340-8
50	2.800 [71.12]	2.400 [60.96]	5104340-9

**Note:** All part numbers are RoHS compliant.

## Universal Ejection Style Pin Headers, Military, Center and Dual Polarized, .100 x .100 [2.54 x 2.54] Centers

### Straight-Thru, 4-Sided .025 [0.64] Sq. Posts



Pin Header with Latches



Pin Header without Latches

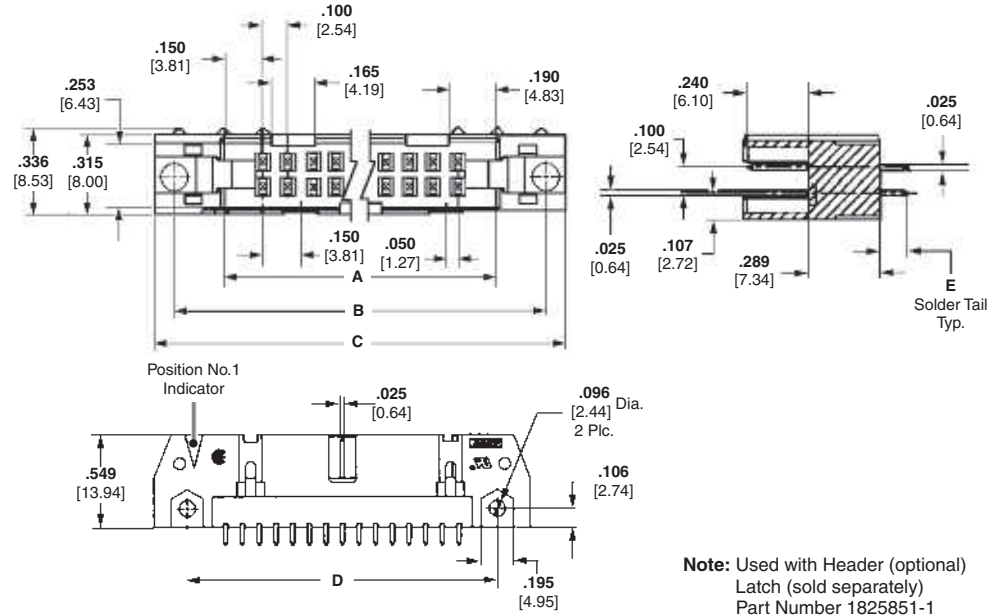

**Note:** Used with Header (optional) Latch (sold separately) Part Number 1825851-1

### Material and Finish

**Housing & Latches** — Black thermoplastic, 94V-0 rated

**Contacts** — Brass or phosphor bronze (at TE's option); Duplex .000030 [0.00076] gold on mating end, .000100 [0.00254] min. tin on termination end, with entire contact underplated .000050 [0.00127] nickel

### Related Product Data

**Electrical Characteristics** — page 134

**Mateable Connectors** — AMPMODU Wire-Applied Receptacles — page 220

### Mounting Information

4-24 self-tapping screws and 2-56 bolts and nuts are available for mounting straight-thru pin headers of pc boards. Typical applications and part nos. for ordering this hardware are presented below.

**Note:** 2-56 bolts and nuts may be used to mount pin headers with and without latches. If latches are to be used, the bolts must be positioned in the pin header before the latches are installed.

**Note:** All part numbers are RoHS compliant.

No. of Positions	Dimensions					Part Number (Without Latches)
	A	B	C	D	E	
10	.700	1.100	1.260	.860	.110 [2.79]	5102154-1
	17.78	27.94	32.00	21.84	.155 [3.94]	5102156-1
14	.900	1.300	1.460	1.060	.110 [2.79]	5102154-2
	22.86	33.02	37.08	26.92	.155 [3.94]	5102156-2
16	1.000	1.400	1.560	1.180	.110 [2.79]	5102154-3
	25.40	35.56	39.62	29.46	.155 [3.94]	5102156-3
20	1.200	1.600	1.760	1.360	.110 [2.79]	5102154-4
	30.48	40.64	44.70	34.54	.155 [3.94]	5102156-4
24	1.400	1.800	1.960	1.560	.110 [2.79]	5102154-5
	35.56	45.72	49.78	39.62	.155 [3.94]	5102156-5
26	1.500	1.900	2.060	1.660	.110 [2.79]	5102154-6
	38.10	48.26	52.32	42.16	.155 [3.94]	5102156-6
34	1.900	2.300	2.460	2.060	.110 [2.79]	5102154-8
	48.26	58.42	62.48	52.32	.155 [3.94]	5102156-8
40	2.200	2.600	2.760	2.360	.110 [2.79]	5102154-9
	55.88	66.04	70.10	59.94	.155 [3.94]	5102156-9
50	2.700	3.100	3.260	2.860	.110 [2.79]	1-5102154-0
	68.58	78.74	82.80	72.64	.155 [3.94]	1-5102156-0

**Notes:** 1. Pin headers in 10- and 14-position sizes have only one slot for snap-in polarizer (military polarization), located as shown.  
2. Pin headers in 10-position size have only slot for dual polarization, located as shown.

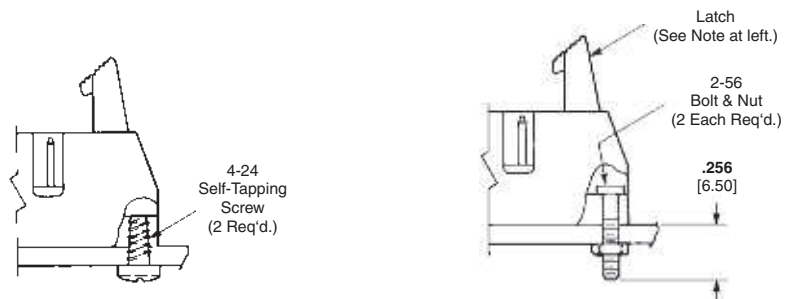

**Pin Header Mounting using 4-24 Self-Tapping Screws:**  
Part No. 19156-1 (for .062 [1.57] Thick PC Board)  
19156-2 (for .093 [2.36] Thick PC Board)  
19156-3 (for .125 [3.18] Thick PC Board)

**Pin Header Mounting with 2-56 Bolts and Nuts:**  
Part No. 746383-1 (Bolt Only)  
Kit No. 102198-1 (Bolt and Nut, 2 Each per Kit)

## Universal Ejection Style Pin Headers, Military, Center and Dual Polarized, .100 x .100 [2.54 x 2.54] Centers (Continued)

### Right-Angle, 4-Sided .025 [0.64] Sq. Posts



Pin Header with Latches



Pin Header without Latches

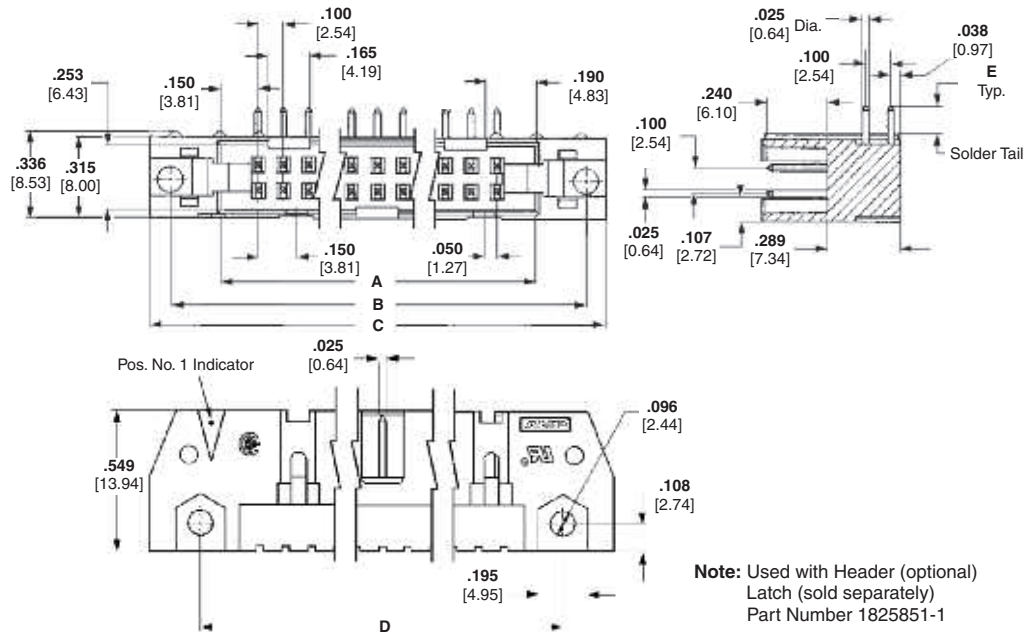

No. of Positions	Dimensions					Part Number (Without Latches)
	A	B	C	D	E	
10	.700	1.100	1.260	.860	.110 [2.79]	5102160-1
	17.78	27.94	32.00	21.84	.155 [3.94]	5102162-1
14	.900	1.300	1.460	1.060	.110 [2.79]	2-5102160-2*
	22.86	33.02	37.08	26.92	.155 [3.94]	2-5102162-2*
16	1.000	1.400	1.560	1.180	.110 [2.79]	5102160-3
	25.40	35.56	39.62	29.46	.155 [3.94]	—
20	1.200	1.600	1.760	1.360	.110 [2.79]	5102160-4
	30.48	40.64	44.70	34.54	.155 [3.94]	—
24	1.400	1.800	1.960	1.560	.110 [2.79]	5102160-5
	35.56	45.72	49.78	39.62	.155 [3.94]	—
26	1.500	1.900	2.060	1.660	.110 [2.79]	5102160-6
	38.10	48.26	52.32	42.16	.155 [3.94]	2-5102162-6*
34	1.900	2.300	2.460	2.060	.110 [2.79]	5102160-8
	48.26	58.42	62.48	52.32	.155 [3.94]	5102162-8
40	2.200	2.600	2.760	2.360	.110 [2.79]	5102160-9
	55.88	66.04	70.10	59.94	.155 [3.94]	—
50	2.700	3.100	3.260	2.860	.110 [2.79]	1-5102160-0
	68.58	78.74	82.80	72.64	.155 [3.94]	1-5102162-0

### Material and Finish

**Housing & Latches** — Black thermoplastic, 94V-0 rated

**Contacts** — Brass or phosphor bronze (at TE's option); Duplex .000030 [0.00076] gold on mating end, .000100 [0.00254] min. tin on termination end, with entire contact underplated .000050 [0.00127] nickel

### Related Product Data

**Electrical Characteristics** — page 134

**Mateable Connectors** — AMPMODU Wire-Applied Receptacles — page 220

### Mounting Information

4-24 self-tapping screws and 2-56 bolts and nuts are available for mounting straight-thru pin headers of pc boards. Typical applications and part nos. for ordering this hardware are presented below.

**Note:** 2-56 bolts and nuts may be used to mount pin headers with and without latches. If latches are to be used, the bolts must be positioned in the pin header before the latches are installed.

**Note:** All part numbers are RoHS compliant.

- Notes:** 1. Pin headers in 10- and 14-position sizes have only one slot for snap-in polarizer (military polarization), located as shown.  
2. Pin headers in 10-position size have only slot for dual polarization, located as shown.  
\*Blue housing.

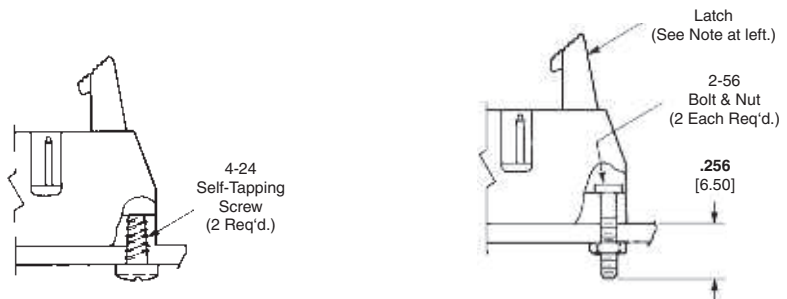

**Pin Header Mounting using 4-24 Self-Tapping Screws:**  
Part No. 19156-1 (for .062 [1.57] Thick PC Board)  
19156-2 (for .093 [2.36] Thick PC Board)  
19156-3 (for .125 [3.18] Thick PC Board)

**Pin Header Mounting with 2-56 Bolts and Nuts:**  
Part No. 746383-1 (Bolt Only)  
Kit No. 102198-1 (Bolt and Nut, 2 Each per Kit)

## AMPMODU Stacking Connectors—Shrouded, .025 x .025 [0.64 x 0.64] Posts

### Product Facts

- Parallel PC board stacking without use of mother boards
- Provides space between boards for interference-free routing of wire-to-board connections
- Two header heights available: .785 [19.94] and 1.200 [30.48]
- Vertical mount headers are fully shrouded
- Receptacle contacts have dual cantilever beams with built-in overstress protection
- .025 [0.64] sq. posts and receptacle contacts on double-row, .100 x .100 [2.54 x 2.54] centers
- Header posts and receptacle contacts are phosphor bronze, duplex plated
- Housings are made of flame retardant, glass-filled thermoplastic

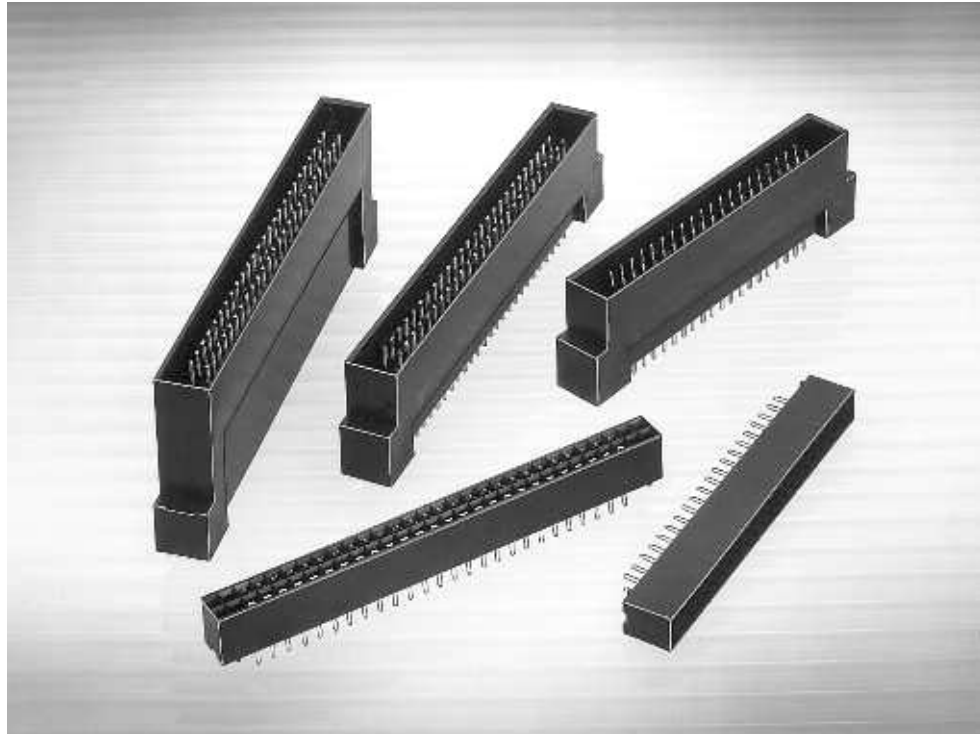

AMPMODU stacking connectors are a two-piece interconnection system designed for parallel stacking printed circuit boards, without the use of mother boards.

Vertical mount headers and receptacle assemblies feature duplex plated posts and receptacle contacts on a double-row, .100 x .100 [2.54 x 2.54] grid. The .025 [0.64] sq. header posts are more protected, and the top-entry receptacle contacts utilize the proven

AMPMODU receptacle contact design; dual cantilever beams with built-in overstress protection.

Headers are available in two heights: .785 [19.94] and 1.200 [30.48]. This allows the customer to use the height of the header to keep wire-to-board connections up and away from other board components, particularly if the components are densely packaged around the header.

## Receptacle Assemblies, Double-Row Board Mounted

**Vertical Mount, Top Entry, High Profile, Selectively Loaded (with Standoffs)**

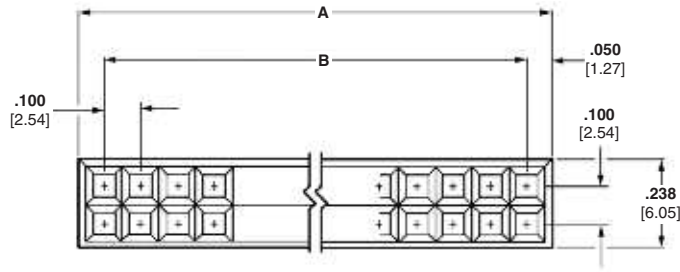

**Material and Finish**

**Housing** — Glass-filled thermoplastic, black, 94V-0 rated

**Contacts** — Phosphor bronze, plated .000010 [0.000254] min. gold on mating area, .000150-.000300 [0.00381-0.00762] matte tin on solder area, with entire contact underplated .000050-.000100 [0.00127-0.00254] nickel

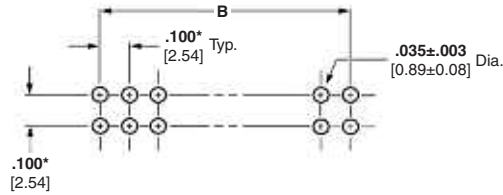
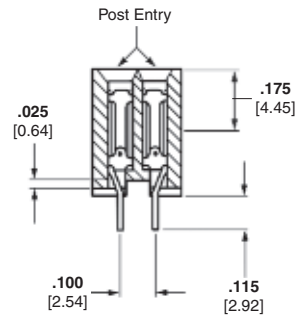
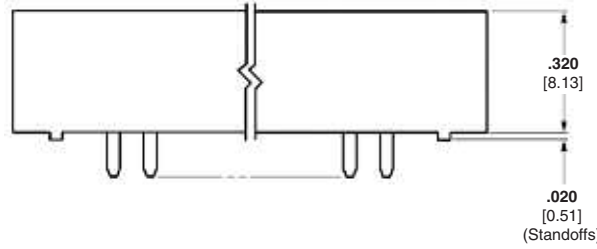

**Recommended PC Board Hole Layout**

\*±.003 [±0.08] tolerances not to accumulate within one connector pattern.

No. of Pos.	Dimensions		Receptacle Assembly Part No.
	A	B	
48* (40 Active)	2.400 [60.96]	2.300 [58.42]	5-102766-1
60* (52 Active)	3.000 [76.2]	2.900 [73.66]	5-102766-4

\*In addition to the *active* positions, each receptacle has four cavities on each end that are not loaded with contacts. These empty cavities aid in aligning the receptacle with header posts during mating.

- Notes:**
1. Part no. and date code stamped on housing where size permits.
  2. These receptacle assemblies mate with headers of the same size as the *active* positions listed above. Refer to pages 143 and 144.

**Note:** All part numbers are RoHS compliant.

## Headers, Double-Row, .785 [19.94] Height

**.025 x .025 [0.64 x 0.64]  
Straight Post (with  
Pin Protection)**

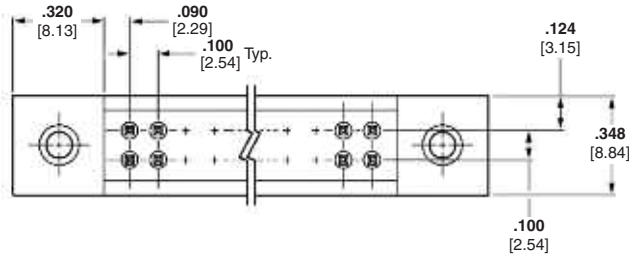
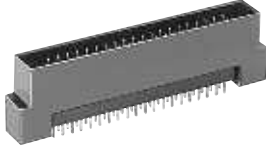

### Material and Finish

**Housing** — Glass-filled thermoplastic, black, 94V-0 rated

**Contacts** — Phosphor bronze, plated .000015 [0.000381] min. gold on mating area, .000100-.000200 [0.00254-.00508] matte tin on solder area, with entire post underplated .000050 [0.00127] nickel

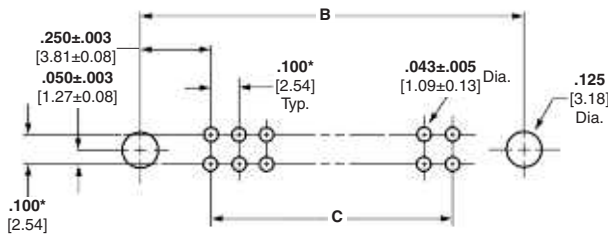
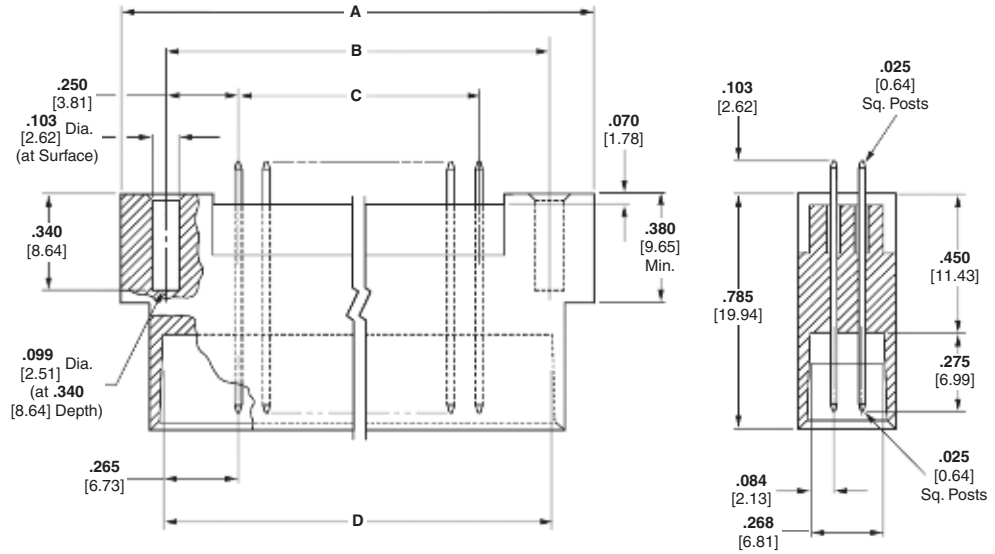

**Recommended PC Board Hole Layout**

\*±.003 [±0.08] tolerances not to accumulate within one connector pattern.

No. of Pos.	Dimensions				Header Part No.
	A	B	C	D	
40	2.720 [69.09]	2.400 [60.96]	1.900 [48.26]	2.430 [61.27]	5-102871-2
52	3.320 [84.33]	3.000 [76.2]	2.500 [63.5]	3.030 [76.96]	5-102871-1

**Note:** These headers mate with receptacle assemblies having the same number of active positions. See page 142.

**Note:** All part numbers are RoHS compliant.

## Headers, Double-Row, 1.200 [30.48] Height

**.025 x .025 [0.64 x 0.64]  
Straight Post (with  
Pin Protection)**



### Material and Finish

**Housing** — Glass-filled thermoplastic, black, 94V-0 rated

**Contacts** — Phosphor bronze, plated .000015 [0.000381] min. gold on mating area, .000100-.000200 [0.00254-0.00508] matte tin on solder area, with entire post underplated .000050 [0.00127] nickel

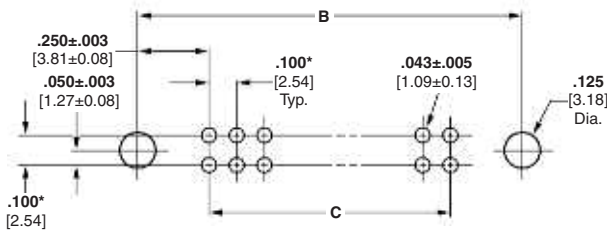
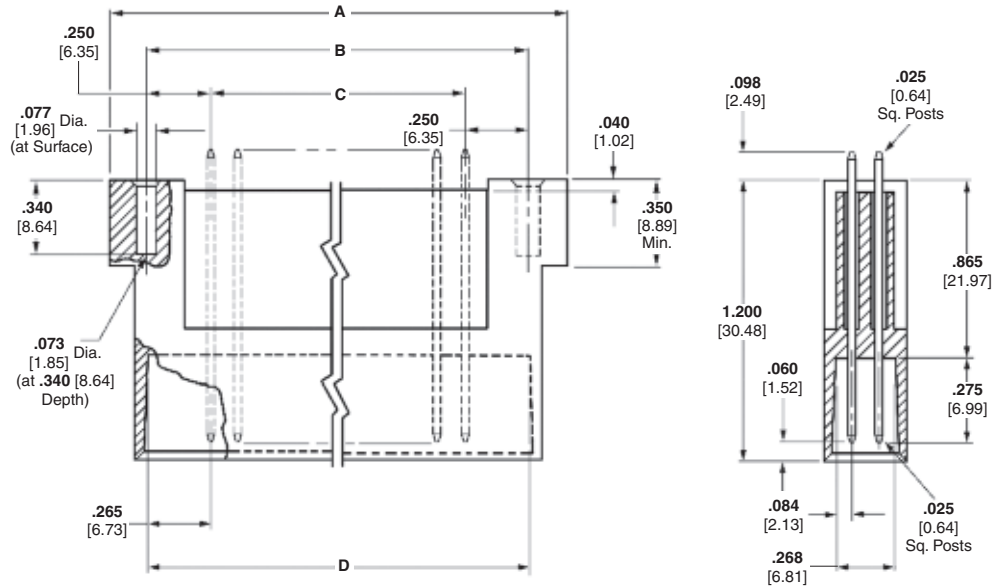
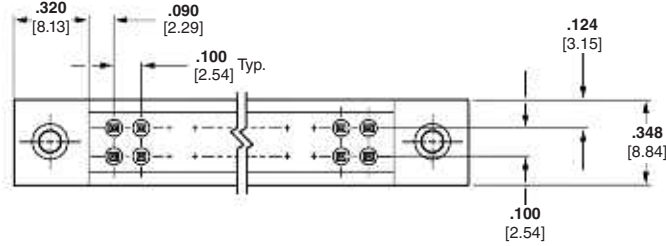

### Recommended PC Board Hole Layout

\*±.003 [±0.08] tolerances not to accumulate within one connector pattern.

No. of Pos.	Dimensions				Header Part No.
	A	B	C	D	
52	3.320 [84.33]	3.000 [76.2]	2.500 [63.5]	3.030 [76.96]	5-102826-1



**Note:** This header mates with receptacle assembly having the same number of active positions. See page 142.

**Note:** All part numbers are RoHS compliant.



## ACTION PIN Headers—Shrouded and Unshrouded

### Product Facts

- Straight posted unshrouded and shrouded versions
- .025 [0.64] square ACTION PIN posts
- ACTION PIN posts make a gas-tight, press-fit connection in plated-through holes
- Designed not to damage plated-through holes
- Unshrouded headers available in selected sizes 1 through 40 positions (single-row) and 4 through 80 positions (double-row)
- Shrouded headers (double-row) available in selected sizes of 6 through 60 positions
- Flame retardant, black thermoplastic housings, 94V-0 rated
- .100 [2.54] Centerline spacing
- Recognized under the Component Program of Underwriters Laboratories Inc.,  File No. E28476
- Certified by Canadian Standards Association,  File No. LR 16455

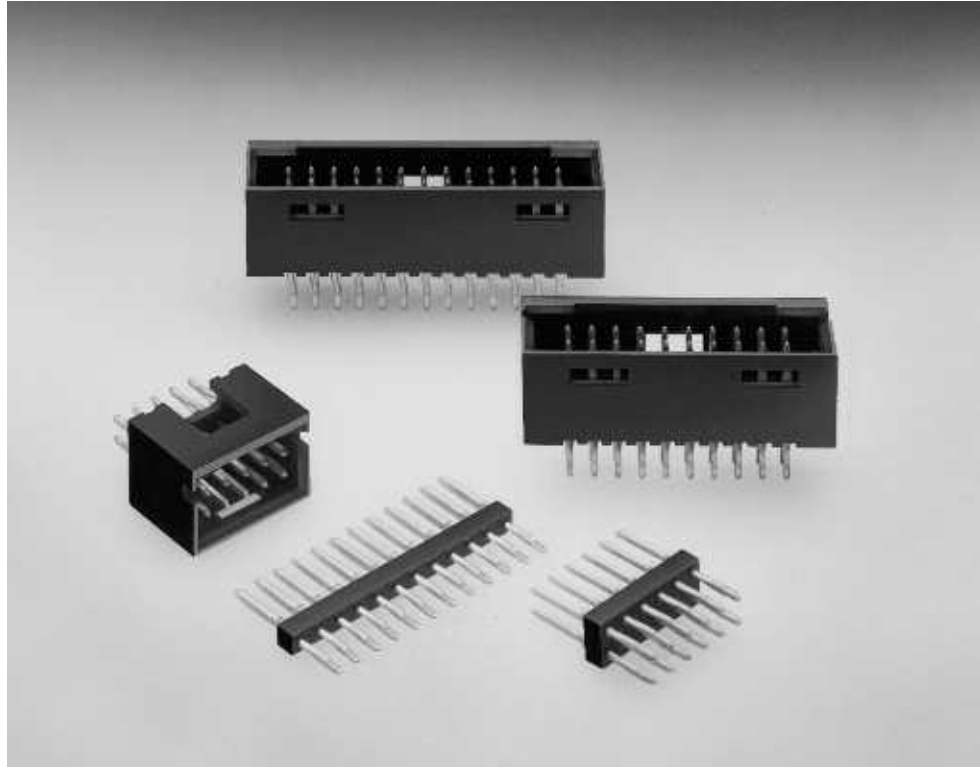

## ACTION PIN Headers—Unshrouded, Single-Row, .100 [2.54] Centerline

### .025 [0.64] Square Straight Post

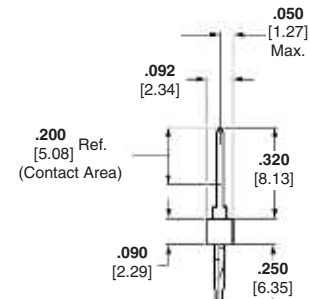
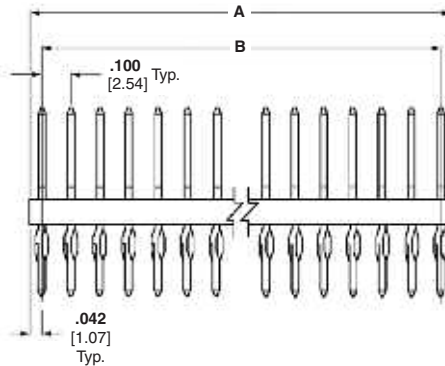

### Material and Finish

**Housing** — Black thermoplastic, 94V-0 rated

**Posts** — Copper alloy, duplex plated .000030 [0.00076] gold on contact area, .000100-.000200 [0.00254-0.00508] matte tin on termination end, with entire post underplated .000050 [0.00127] nickel

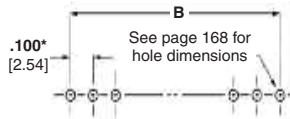

**Recommended PC Board Hole Layout**  
\*±.003 [±0.08] tolerances not to accumulate within one connector pattern.

### Related Product Data

#### Mateable Connectors —

Refer to the Mating Post Selection Guide — page 90

**ACTION PIN Posts** — pages 150, 151

**Application Tooling** — page 152

#### Technical Documents — page 276

See mating connector for applicable product and application specifications

No. of Pos.	Dimensions		Part Nos.	
	A	B	For .062 [1.57] Thick PC Boards	For .093-.125 [2.36-3.18] Thick PC Boards
1	.084 [2.13]	—	8-103336-5	8-102898-5
2	.184 [4.67]	.100 [2.54]	8-103336-4	8-102898-4
3	.284 [7.21]	.200 [5.08]	9-103336-0	9-102898-0
4	.384 [9.75]	.300 [7.62]	8-103336-6	8-102898-6
5	.484 [12.29]	.400 [10.16]	8-103336-8	8-102898-8
6	.584 [14.83]	.500 [12.70]	8-103336-7	8-102898-7
7	.684 [17.37]	.600 [15.24]	8-103336-9	8-102898-9
8	.784 [19.91]	.700 [17.78]	5-103336-1	5-102898-1
9	.884 [22.45]	.800 [20.32]	5-103336-2	5-102898-2
10	.984 [24.99]	.900 [22.86]	5-103336-3	5-102898-3
11	1.084 [27.53]	1.000 [25.40]	5-103336-4	5-102898-4
12	1.184 [30.07]	1.100 [27.94]	5-103336-5	5-102898-5
13	1.284 [32.61]	1.200 [30.48]	5-103336-6	5-102898-6
14	1.384 [35.15]	1.300 [33.02]	5-103336-7	5-102898-7
15	1.484 [37.69]	1.400 [35.56]	5-103336-8	5-102898-8
16	1.584 [40.23]	1.500 [38.10]	5-103336-9	5-102898-9
17	1.684 [42.77]	1.600 [40.64]	6-103336-0	6-102898-0
18	1.784 [45.31]	1.700 [43.18]	6-103336-1	6-102898-1
19	1.884 [47.85]	1.800 [45.72]	6-103336-2	6-102898-2
20	1.984 [50.39]	1.900 [48.26]	6-103336-3	6-102898-3
21	2.084 [52.93]	2.000 [50.80]	—	6-102898-4
22	2.184 [55.47]	2.100 [53.34]	—	6-102898-5
23	2.284 [58.01]	2.200 [55.88]	—	6-102898-6
24	2.384 [60.55]	2.300 [58.42]	—	6-102898-7
25	2.484 [63.09]	2.400 [60.96]	6-103336-8	6-102898-8
26	2.584 [65.63]	2.500 [63.50]	—	6-102898-9
27	2.684 [68.17]	2.600 [66.04]	—	7-102898-0
28	2.784 [70.71]	2.700 [68.58]	—	7-102898-1
29	2.884 [73.25]	2.800 [71.12]	—	7-102898-2
30	2.984 [75.79]	2.900 [73.66]	7-103336-3	7-102898-3
32	3.184 [80.87]	3.100 [78.74]	7-103336-5	7-102898-5
36	3.584 [91.03]	3.500 [88.90]	7-103336-9	7-102898-9
40	3.984 [101.19]	3.900 [99.06]	8-103336-3	8-102898-3

**Note:** To insert header into PC board, use seating tool with arbor tool or air powered machine—page 152.

**Note:** All part numbers are RoHS compliant.

## ACTION PIN Headers—Unshrouded, Double-Row, .100 x .100 [2.54 x 2.54] Centerline

### .025 [0.64] Square Straight Post



#### Material and Finish

**Housing** — Black thermoplastic, 94V-0 rated

**Posts** — Copper alloy, duplex plated .000030 [0.00076] gold on contact area, .000100-.000200 [0.00254-0.00508] matte tin on termination end, with entire post underplated .000050 [0.00127] nickel

#### Related Product Data

**Mateable Connectors** — Refer to the Mating Post Selection Guide — page 90

**ACTION PIN Posts** — pages 150, 151

**Application Tooling** — page 152

#### Accessories

**Barrier Insert** — page 204

#### Technical Documents

See mating connector for applicable product and application specifications

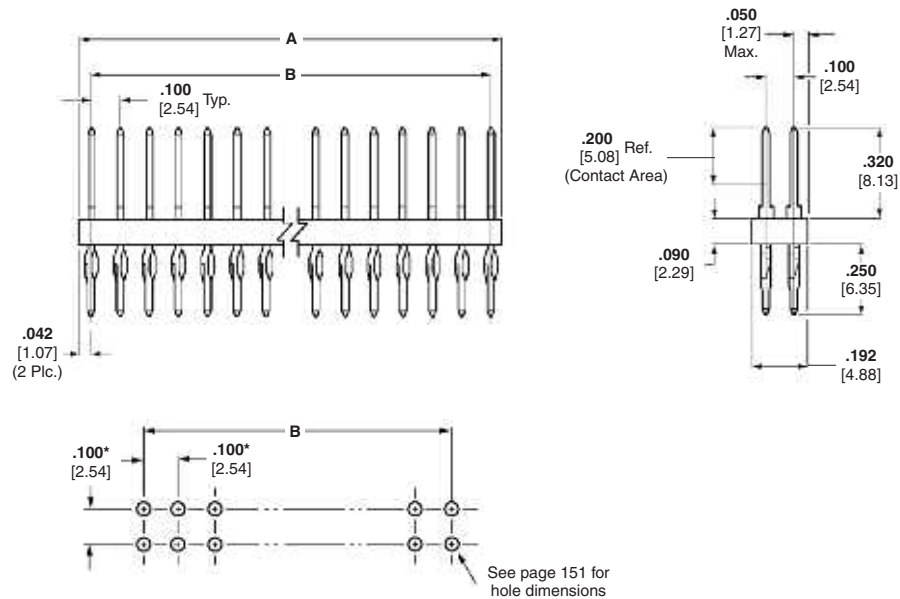

#### Recommended PC Board Hole Layout

\*±.003 [±0.08] tolerances not to accumulate within one connector pattern.

No. of Pos.	Dimensions		Part Nos.	
	A	B	For .062 [1.57] Thick PC Boards	For .093-.125 [.236-3.18] Thick PC Boards
4	.184 [4.67]	.100 [2.54]	5-103542-1	5-103233-1
6	.284 [7.21]	.200 [5.08]	5-103542-2	5-103233-2
8	.384 [9.75]	.300 [7.62]	5-103542-3	5-103233-3
10	.484 [12.29]	.400 [10.16]	5-103542-4	5-103233-4
12	.584 [14.83]	.500 [12.70]	5-103542-5	5-103233-5
14	.684 [17.37]	.600 [15.24]	5-103542-6	5-103233-6
16	.784 [19.91]	.700 [17.78]	5-103542-7	5-103233-7
18	.884 [22.45]	.800 [20.32]	5-103542-8	5-103233-8
20	.984 [24.99]	.900 [22.86]	5-103542-9	5-103233-9
22	1.084 [27.53]	1.000 [25.40]	6-103542-0	6-103233-0
24	1.184 [30.07]	1.100 [27.94]	6-103542-1	6-103233-1
26	1.284 [32.61]	1.200 [30.48]	6-103542-2	6-103233-2
28	1.384 [35.15]	1.300 [33.02]	6-103542-3	6-103233-3
30	1.484 [37.69]	1.400 [35.56]	6-103542-4	6-103233-4
32	1.584 [40.23]	1.500 [38.10]	6-103542-5	6-103233-5
34	1.684 [42.77]	1.600 [40.64]	6-103542-6	6-103233-6
36	1.784 [45.31]	1.700 [43.18]	6-103542-7	6-103233-7
38	1.884 [47.85]	1.800 [45.72]	6-103542-8	6-103233-8
40	1.984 [50.39]	1.900 [48.26]	6-103542-9	6-103233-9
42	2.084 [52.93]	2.000 [50.80]	7-103542-0	7-103233-0
46	2.284 [58.01]	2.200 [55.88]	7-103542-2	—
50	2.484 [63.09]	2.400 [60.96]	7-103542-4	7-103233-4
60	2.984 [75.79]	2.900 [73.66]	7-103542-9	7-103233-9
66	3.284 [83.41]	3.200 [81.28]	8-103542-2	—
80	3.984 [101.19]	3.900 [99.06]	8-103542-9	8-103233-9

**Note:** All part numbers are RoHS compliant.

## ACTION PIN Headers—Shrouded with .066 [1.68] End Dimension, Double-Row, .100 x .100 [2.54 x 2.54] Centerline

**.025 [0.64] Square Straight Post (with Detent Windows, for .093-.125 [2.36-3.18] Thick PC Board)**

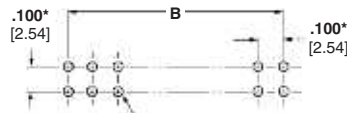
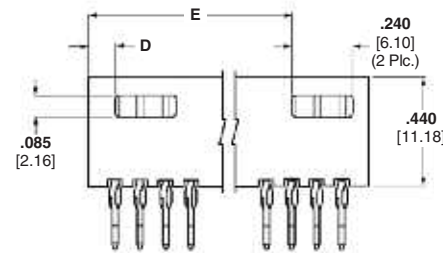
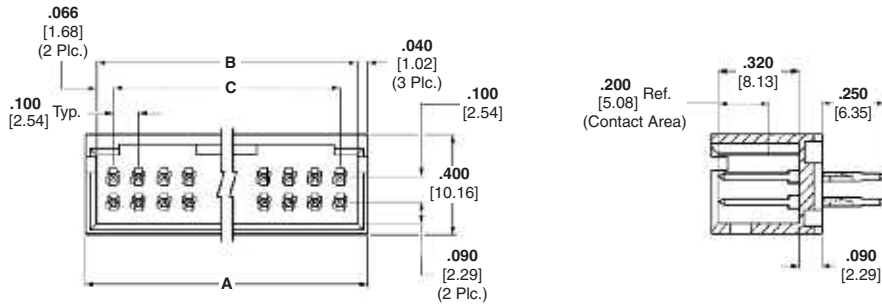
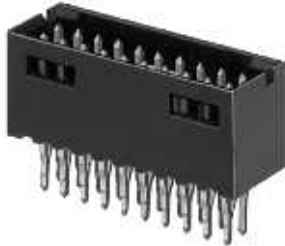

See page 151 for hole dimensions

### Recommended PC Board Hole Layout

\*±.003 [±0.08] tolerances not to accumulate within one connector pattern.

### Material and Finish

**Housing** — Black thermoplastic, 94V-0 rated

**Posts** — Copper alloy, duplex plated .000030 [0.00076] gold on contact area, .000100-.000200 [0.00254-0.00508] matte tin on termination end, with entire post underplated .000050 [0.00127] nickel

### Related Product Data

**Mateable Connectors** —

**AMPMODU Board Mount Receptacles** — pages 176, 179, 180

**AMPMODU Wire-Applied Receptacles** — pages 217-219

**AMPMODU MT Receptacles** — pages 256, 257

**ACTION PIN Posts** — pages 150, 151

**Application Tooling** — page 152

### Accessories

**Barrier Insert** — page 204

### Technical Documents

See mating connector for applicable product and application specifications

No. of Pos.	Dimensions					Header Part Nos.
	A	B	C	D	E	
6	.412 [10.46]	.332 [8.43]	.200 [5.08]	.106 [2.69]	—	5-102699-2
8	.512 [13.00]	.432 [10.97]	.300 [7.62]	.106 [2.69]	—	5-102699-3
10	.612 [15.54]	.532 [13.51]	.400 [10.16]	.206 [5.23]	—	5-102699-4
12	.712 [18.08]	.632 [16.05]	.500 [12.70]	.206 [5.23]	—	5-102699-5
14	.812 [20.62]	.732 [18.59]	.600 [15.24]	.306 [7.77]	—	5-102699-6
16	.912 [23.16]	.832 [21.13]	.700 [17.78]	.306 [7.77]	—	5-102699-7
18	1.012 [25.70]	.932 [23.67]	.800 [20.32]	.406 [10.31]	—	5-102699-8
20	1.112 [28.24]	1.032 [26.21]	.900 [22.86]	.106 [2.69]	.806 [20.47]	5-102699-9
26	1.412 [35.86]	1.332 [33.83]	1.200 [30.48]	.106 [2.69]	1.106 [28.09]	6-102699-2
30	1.612 [40.94]	1.532 [38.91]	1.400 [35.56]	.106 [2.69]	1.306 [33.17]	6-102699-4
34	1.812 [46.02]	1.732 [43.99]	1.600 [40.64]	.106 [2.69]	1.506 [38.25]	6-102699-6
40	2.112 [53.64]	2.032 [51.61]	1.900 [48.26]	.106 [2.69]	1.806 [45.87]	6-102699-9
50	2.612 [66.34]	2.532 [64.31]	2.400 [60.96]	.106 [2.69]	2.306 [58.57]	7-102699-3
60	3.112 [79.04]	3.032 [77.01]	2.900 [73.66]	.106 [2.69]	2.806 [71.27]	7-102699-8

**Note:** All part numbers are RoHS compliant.

## ACTION PIN Headers—Shrouded with .150 [3.81] End Dimension, Double-Row, .100 x .100 [2.54 x 2.54] Centerline

**.025 [0.64] Square Straight Post (with Detent Windows, for .093-.125 [.236-3.18] Thick PC Board)**



### Material and Finish

**Housing** — Black thermoplastic, 94V-0 rated

**Posts** — Copper alloy, duplex plated .000030 [0.00076] gold on contact area, .000100-.000200 [0.00254-0.00508] matte tin on termination end, with entire post underplated .000050 [0.00127] nickel

### Related Product Data

**Mateable Connectors** —

**AMPMODU MTE Receptacles** — pages 232, 233

**ACTION PIN Posts** — pages 150, 151

**Application Tooling** — page 152

### Accessories

**Barrier Insert** — page 204

### Technical Documents

See mating connector for applicable product and application specifications

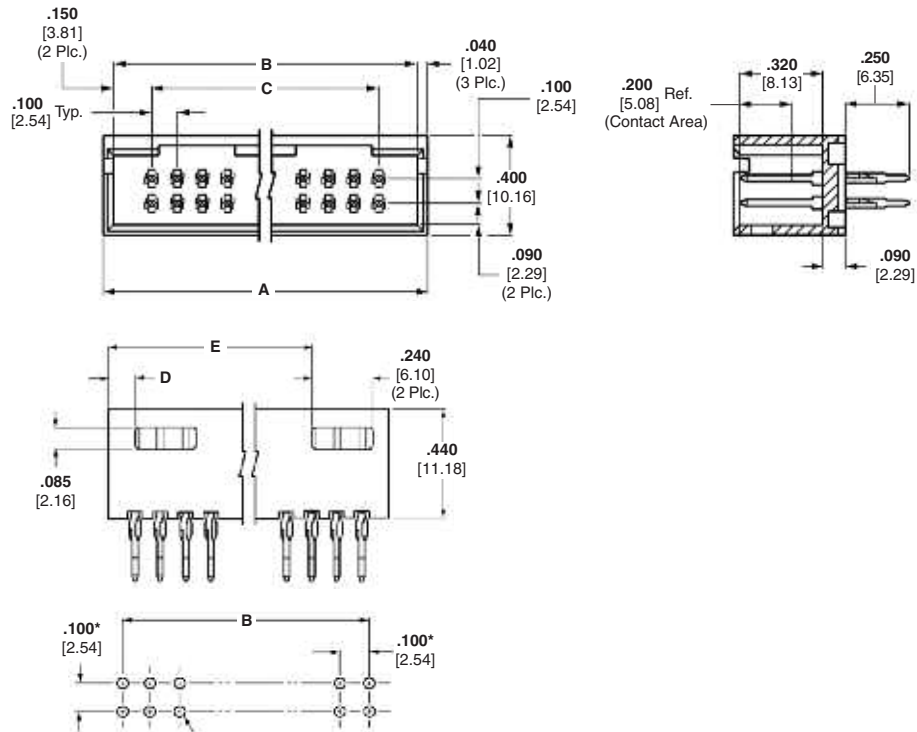

See page 151 for hole dimensions

### Recommended PC Board Hole Layout

\*±.003 [±0.08] tolerances not to accumulate within one connector pattern.

No. of Pos.	Dimensions					Header Part Nos.
	A	B	C	D	E	
6	.580 [14.73]	.500 [8.43]	.200 [5.08]	.190 [4.83]	—	6-102557-0
8	.680 [17.27]	.600 [10.97]	.300 [7.62]	.190 [4.83]	—	6-102557-1
10	.780 [19.81]	.700 [17.78]	.400 [10.16]	.290 [7.37]	—	5-102557-9
12	.880 [22.35]	.800 [20.32]	.500 [12.70]	.290 [7.37]	—	6-102557-2
14	.980 [24.89]	.900 [22.86]	.600 [15.24]	.390 [9.91]	—	6-102557-3
16	1.080 [27.43]	1.000 [25.40]	.700 [17.78]	.390 [9.91]	—	6-102557-4
18	1.180 [29.97]	1.100 [27.94]	.800 [20.32]	.490 [10.31]	—	6-102557-5
20	1.280 [32.51]	1.200 [30.48]	.900 [22.86]	.190 [4.83]	.890 [22.61]	5-102557-2
24	1.480 [37.59]	1.400 [35.56]	1.100 [27.94]	.190 [4.83]	1.090 [27.69]	6-102557-7
26	1.580 [40.13]	1.500 [38.10]	1.200 [30.48]	.190 [4.83]	1.190 [30.23]	5-102557-3
30	1.780 [45.21]	1.700 [43.18]	1.400 [35.56]	.190 [4.83]	1.390 [35.31]	5-102557-4
34	1.980 [50.29]	1.900 [48.26]	1.600 [40.64]	.190 [4.83]	1.590 [40.39]	5-102557-5
40	2.280 [57.91]	2.200 [55.88]	1.900 [48.26]	.190 [4.83]	1.890 [48.01]	5-102557-1
50	2.780 [70.61]	2.700 [68.58]	2.400 [60.96]	.190 [4.83]	2.390 [60.71]	5-102557-6
60	3.280 [83.31]	3.200 [81.28]	2.900 [73.66]	.190 [4.83]	2.890 [73.41]	5-102557-7

**Note:** All part numbers are RoHS compliant.

## ACTION PIN Press-Fit Posts

### The Reliable Plated-Through Hole Interconnect

Solderless interconnections have been popular in electrical and electronic applications with world-wide success for decades. They provide reliable electrical and mechanical stability and offer applied-cost savings across the board. For PC board applications, compliant ACTION PIN posts provide these features:

- Large gas-tight contact zone
- High reliability due to stored energy
- More resistant to damage to plated-through holes during installation
- Especially suited for multilayer PC boards
- Less costly board manufacturing due to larger hole tolerances compared to use of solid pins
- Application can be made by end-user
- Repairability—contact can be replaced in the same pin location (two repairs)
- Installation with no heat cycling of board
- Permits mass insertion by minimizing forces needed to insert pins as compared to solid pin press-fit application
- Significant applied-cost savings in many applications

Since compliant ACTION PIN posts do not have to be soldered, problems associated with solder are eliminated, such as:

- Faulty solder joints
- Solder fumes; contaminants are deposited on the contacts
- Solder spots; short circuits between printed circuits
- Flux residuals
- Thermal strain on printed circuit boards and components
- Degassing of plated-through holes

Solderless press-fit interconnections using compliant pins are primarily integrated in, but not limited to, backplanes.

Solderless press-fit interconnections are used in racks, especially where connectors must be fixed on the solder side of the PC board and/or component side. In these applications, the holes for ACTION PIN post connectors are covered during the soldering process and press-fitting is performed after soldering.

Other applications for ACTION PIN post interconnections include PC boards that incorporate components using surface mount technology (SMT). Here, too, press-fit interconnections can be applied after soldering, thus eliminating complications associated with connectors suitable for surface mounting.

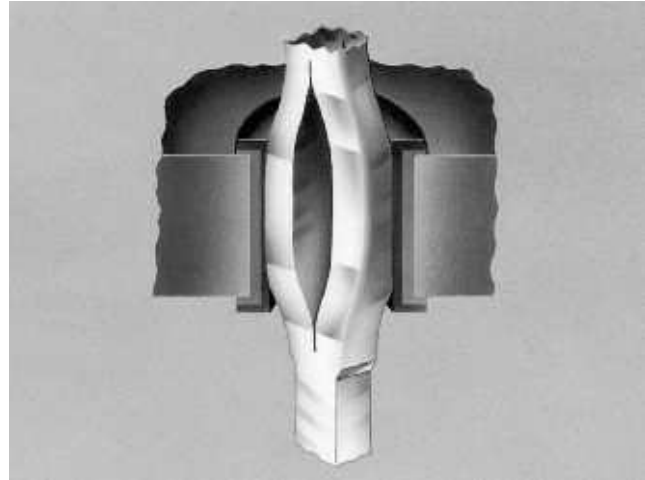

### Principle of the Compliant ACTION PIN Post

When a compliant ACTION PIN post is inserted into a plated-through hole, two spring members are compressed, exerting force against the hole for a gas-tight connection. The diameter of the hole is smaller than the diagonal size of the pin (see cross-section illustration below).

The beam characteristics of the pin are designed so that a plastic, as well as an elastic, deformation takes place during insertion. The two spring members compress to different degrees to accommodate hole tolerances. The compliant pin also reduces strain on the board. With a rigid pin, the elastic strain energy is stored entirely in the board, leading to damage of the plated-through holes. With the compliant ACTION PIN post, the residual force of the elastic deformation maintains stored energy to produce a tight contact zone between the pin and the plated-through hole. This maintains long-term electrical and mechanical reliability of the interconnection.



Minimum  
Hole Dia.  
.037 [0.94]

Maximum  
Hole Dia.  
.043 [1.09]

Cross-Section Area of ACTION PIN Press-Fit Post in Printed Circuit Board Holes

**ACTION PIN Press-Fit Posts** (Continued)



ACTION PIN posts provide a more reliable press-fit connection. Localized pressure in the interface area provides oxide break-through and prevents corrosion better in many of the harshest environments to help provide a reliable connection. Also, radial and axial distortion are controlled to meet today's standards for multilayer board applications.

**PC Board Thickness**

ACTION PIN posts are designed for use in a variety of PC board thicknesses. However, certain ACTION PIN posts are to be used in specific ranges of board thicknesses. To promote optimum performance, the recommended board thicknesses provided with the connector being used must be followed.

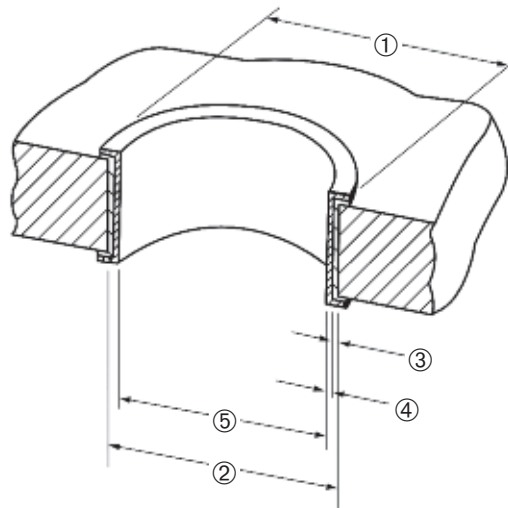

- ① Annular Ring (See Note)
- ② Drilled Hole
- ③ Copper Thickness
- ④ Tin-lead Thickness
- ⑤ Plated-Through Hole

**ACTION PIN Post/PC Board Applications**

ACTION PIN Contact Material Thickness	Drilled Hole Diameter <sup>②</sup>	Plating Thicknesses		Plated-Through Hole Diameter <sup>⑤</sup>	Distortion Specification*	
		Copper <sup>③*</sup>	Tin-lead <sup>④</sup>		Average	Maximum
.025 [0.64]	.0453 <sup>+0.001</sup> [1.151 <sup>+0.03</sup> ]	.001-.003 [0.03-0.08]	.0003 [0.008]Min.	.037-.043 [0.94-1.09]	.0015 [0.038]	.002 [0.05]

\*Maximum hardness of copper layer is 150 Knoop.  
 \*\*Radial hole distortion.

**Note:** Recommended annular ring diameter is hole diameter plus .020 [0.51].

## Application Tooling for AMPMODU Headers with ACTION PIN Posts

### ACTION PIN Post Replacement Tooling



**Rear Insertion/Extraction Tool No. 265871-7 (Ref. 408-2636) Includes:**

- Impact Tool No. 380392-8
- Removal Tool No. 265964-1
- Replacement Tip No. 308554-1

### Single-Row Connector Seating Tools

Tooling Assembly No. 91171-1 is used to install single-row AMPMODU headers with ACTION PIN posts into PC boards.

Pin headers with ACTION PIN posts allow high speed, solderless back-plane construction through press-fit application. Press fitting connectors to printed circuit boards requires special seating tools which transfer application force directly to the contacts.

Force applied to the tool to seat the connectors can be provided by the TE seating machines shown on this page.

For tooling information, call the TE Automation Group 1-800-722-1111.

### Double-Row Connector Seating Tools

Header Size (No. of Pos.)	Tool Assembly No.
4	91170-1
6	91170-1
8	91170-2
12	91170-5
14	91170-6
16	91170-7
20	91170-9
24	1-91170-1
30	1-91170-4
36	1-91170-7
40	1-91170-9
50	2-91170-4
60	2-91170-9
80	3-91170-2
96	3-91170-5
100	3-91170-6
120	3-91170-8
140	4-91170-0
200	4-91170-2

### Triple-Row Connector Seating Tools

Header Size (No. of Pos.)	Tool Assembly No.
96	91169-8
105	91169-6
120	91169-7
150	91169-3
195	91169-2
204	91169-1
210	91169-5
300	91169-9

Application Tooling for ACTION PIN Posts

5



**BMEP 5T**



**AEP 6T**

### ASG Servo Electric Presses

TE offers a wide range of servo-electric presses for the application of press-fit connectors. Systems are available with varying force capacity, board size capacity and process capability. Each system features real-time force feedback and PC control to allow the highest level of control and traceability. Every connector

pressed is monitored to confirm that maximum force is not exceeded and minimum force is met. Each system controls force, height and speed to allow termination of the pressing cycle by force or height parameters. Complete SPC data is available as each connector press cycle is monitored and stored.

Please see the matrix below and contact TE Automation Group at 1-800-722-1111 for assistance in understanding which system will best meet your needs.

Press Model	Description	Max Pressing Force tons [kN]	Max Board Size (L x W) in [mm]
BMEP 3T	Semi-automatic, benchtop servo-electric press	3 [26.7]	18 x 24 [460 x 610]
BMEP 5T	Semi-automatic, benchtop servo-electric press	5 [44.5]	18 x 24 [460 x 610]
MEP 6T	Semi-automatic, stand-alone servo-electric press	6 [53.4]	24 x 36 [610 x 914]
MEP 12T	Semi-automatic, stand-alone servo-electric press	12 [106.8]	30 x 36 [762 x 914]
AEP 12T	Automatic, inline servo-electric press	12 [106.8]	36 x 48 [914 x 1219]
AEP 6T	Automatic, stand alone servo-electric press	6 [53.4]	30 x 36 [762 x 914]

**Note:** All part numbers are RoHS compliant.



## Application Tooling for Post Insertion

TE offers a wide range of application tooling solutions ranging from stand alone manual insertion systems through fully automatic inline systems. Please contact your local TE representative or the TE Tooling Assistance Center at 1-800-722-1111 for help in finding the right solution to meet your particular requirements.

### Modular Insertion System Bench Machine No. 217600-1

This machine uses TE insertion heads to install a variety of printed circuit board products at rates of 2,000 per hour. The printed circuit board is placed in a Board Holding Fixture which is attached to a two-hand controlled mechanism. The operator moves the board over the machine anvil; a switch in the anvil actuates the machine when the printed circuit board is placed on the anvil. A spotlight illuminates the insertion area.

Consult TE for further information on this machine and the insertion heads.



### P300 and P350 Automatic Insertion Machines

The P300 and P350 are automatic insertion machines for the application of reeled compliant pin and thru-hole products. Systems are available as stand alone or fully inline with SMEMA compatible conveyor system. Up to 3 different insertion heads can be mounted on a system allowing one machine to apply up to 3 different products. Insertion rates of up to 3 insertions per second on the P300 and up to 5 insertions per second on a P350 are possible (application dependent). PCBs up to 15.5" x 23.5" [400x600mm] on the P300 and up to 17.5" x 17.5" [450x450mm] on the P350 can be processed by high speed XY positioning tables. A wide range of options, including force monitoring, PCB vision correct, and PCB thickness measurement are available to meet your performance and production flexibility requirements.

**Note:** All part numbers are RoHS compliant.

## ACTION PIN Stacking Connector System (Non-Intermateable with AMPMODU Connectors)

### Product Facts

- Can stack multiple printed circuit boards without the need of a mother board
- Connect bus lines in the shortest possible distance
- Receptacle assembly has ACTION PIN posts for solderless board mounting
- Can be mounted onto the board simply by press fitting with Mini-Press
- Receptacle assembly is easy to service and replace (up to 2 times)
- Receptacle contacts are of fork design to mate with posts at two points. Virtually eliminates danger of scooping at mating/unmating
- Stacking dimensions are 13.4 [.528] or 19.0 [.748] when using receptacle assemblies together, and 13.9 [.547] or 19.5 [.768] when using a combination of receptacle and post header assemblies
- Accepts 1.6 [.062] thick boards
- Housing provided with polarization to help prevent mismatching
- Housing made of chemical-resistant glass-filled PBT, black in color
- Contacts are of copper alloy material with high spring characteristics, gold-over-nickel plated
- Post hood available to protect the post portion of receptacle contacts. Can be selected depending on stacking dimensions
- Connectors available in sizes of 26, 30, 34, 40, 50 and 60 positions
- Product specification: 108-5197

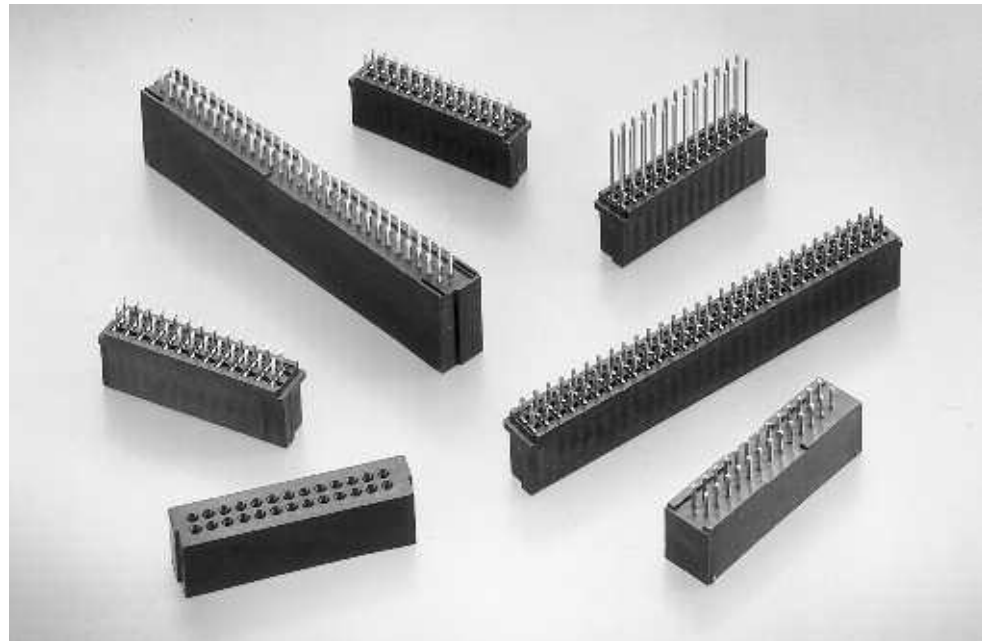

ACTION PIN Stacking Connectors are a family of two-piece connectors used to stack multiple printed circuit boards in parallel. They have been developed to provide a more reliable and economical means of compact wiring and high-density packaging inside a variety of electronic equipment.

The connectors have many advanced features: they can be used to connect

bus lines in the shortest possible distance without the need of a mother board, thus permitting effective utilization of space above the board; compared with other methods of jumper connection using cable connectors, they make the overall board layout more clean and straight for compact packaging.

Contacts are on 2.54 x 2.54 [.100 x .100] grid. The connectors are available in

sizes of 26, 30, 34, 40, 50 and 60 positions. ACTION PIN Stacking Connectors consist of a receptacle assembly, a mating post header and a post hood to protect the post portion of the receptacle assembly.

A complete description of the ACTION PIN Stacking Connectors is presented on the following page (155).

## ACTION PIN Stacking Connector System (Non-Intermateable with AMPMODU Connectors) (Continued)

### Receptacle Assembly

The receptacle assembly features reliability and economy characteristic of this product line.

The mating portion of its built-in receptacle contacts is a fork design, highly resilient and helps prevent damage to contacts by scooping at mating/unmating.

On the board mount side of the assembly are 0.55 [.022] square ACTION PIN posts.

No soldering is required to mount the assembly on the board, the posts being simply, press fit into the board's 0.825 [.032] diameter holes.

Two types of receptacle assemblies are available;

one is used with an outermost board and the other with intermediary boards. A solder version is also available for the outer board mount assembly.

### Post Hood

When using the intermediary board mount receptacle assembly, this post hood is used to protect the post portion of the assembly. The post hood is available in two types: one with the housing height of 10.0 [.394] and the other with the housing height of 15.7 [.618]. They can be selected, depending on stacking dimensions.

### Post Header

The post header is mounted onto the outer board on the other side of the board to

which an outer board mount receptacle assembly is applied. The post header is preloaded with 0.50 [.022] square soldering posts. These posts are protected by the side walls of the housing.

Stacking dimensions provided by this connector line are as follows:

When the outer board receptacle and intermediary board receptacle assemblies are used 13.4 [.528] or 19.0 [.748].

When the intermediary board receptacle assembly and the post header assembly are used 13.9 [.547] or 19.5 [.768].

### Typical Application

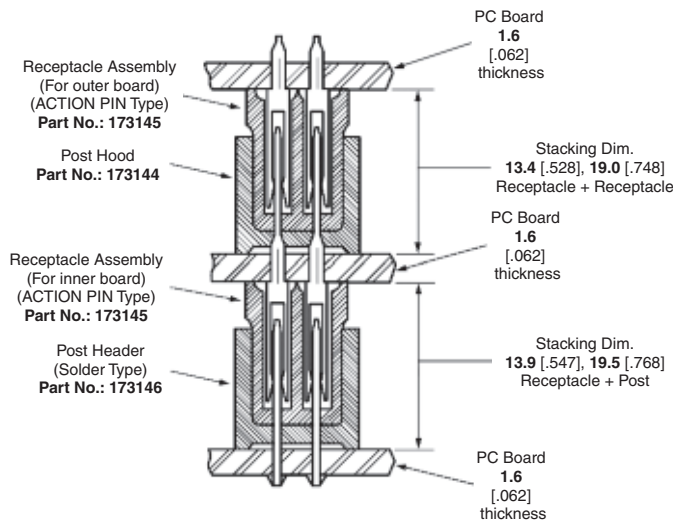

**Note:** All part numbers are RoHS compliant.

**Post Hood (Non-Intermateable with AMPMODU Connectors)**



The post hood, mounted onto the post of the intermediary receptacle assembly, protects the post and serves as a header assembly when stacking several boards.

**Material**

Black glass-filled PBT, 94V-0 rated

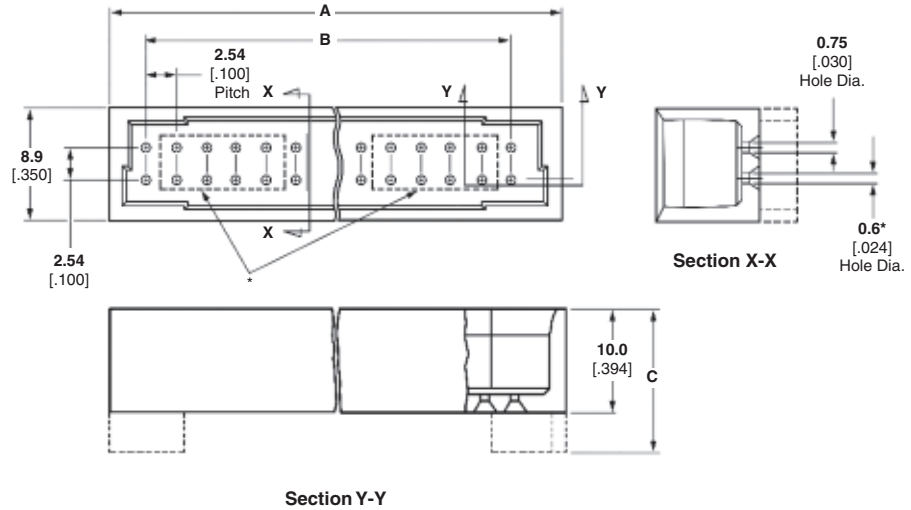

Stacking Connectors, Post Hood

5

Acceptable Post Length	No. of Pos.	Dimensions (See Note.)			Post Hood Part Nos.
		A	B	C	
For 8.9 [.350] or 10.9 [.429] (For Stacking Dimension) 13.4 [.528]	26	38.1 [1.500]	30.48 [1.200]	10.0 [.394]	1-173144-1
	30	43.2 [1.700]	33.56 [1.321]	10.0 [.394]	173144-2
	34	48.3 [1.900]	40.64 [1.600]	10.0 [.394]	1-173144-2
	40	55.9 [2.200]	48.26 [1.900]	10.0 [.394]	173144-3
	50	68.6 [2.700]	65.96 [2.597]	10.0 [.394]	173144-4
	60	81.3 [3.200]	73.66 [2.900]	10.0 [.394]	173144-5
For 14.5 [.571] or 16.5 [.650] (For Stacking Dimension) 19.0 [.748]	26	38.1 [1.500]	30.48 [1.200]	15.6 [.614]	1-173144-3
	30	43.2 [1.700]	33.56 [1.321]	15.6 [.614]	173144-7
	34	48.3 [1.900]	40.64 [1.600]	15.6 [.614]	1-173144-4
	40	55.9 [2.200]	48.26 [1.900]	15.6 [.614]	173144-8
	50	68.6 [2.700]	65.96 [2.597]	15.6 [.614]	3-173144-8*
	60	81.3 [3.200]	73.66 [2.900]	15.6 [.614]	173144-9
	60	81.3 [3.200]	73.66 [2.900]	15.6 [.614]	1-173144-0

\*0.60 [.024] dia. applies to 16 holes on both sides, except Part No. 3-173144-8.

**Note:** All part numbers are RoHS compliant.

**Receptacle Assembly for Outer Board (With 0.55 [.022] Square Post)**



**Material and Finish**

**Housing** — Black glass-filled PBT, 94V-0 rated

**Contacts** — Copper alloy, plated 0.00020 [.000008] gold on contact area and post mating area, gold flash on ACTION PIN tail or 0.000070 [.0000027] tin on solder tail, with entire contact underplated 0.00130 [.000050] nickel

**Application Tooling** shown on page 162.

**PC Board Mounting Dimensions**

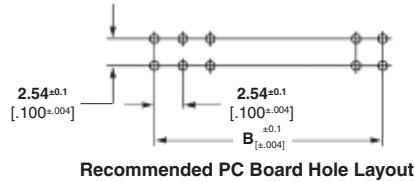
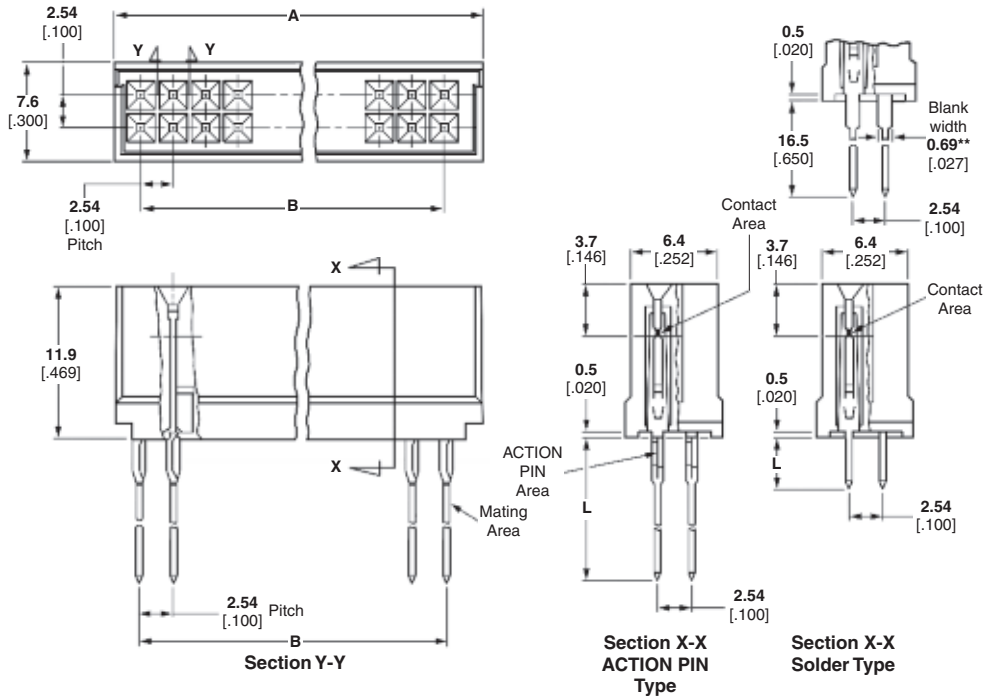
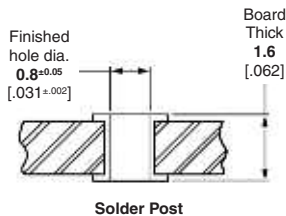
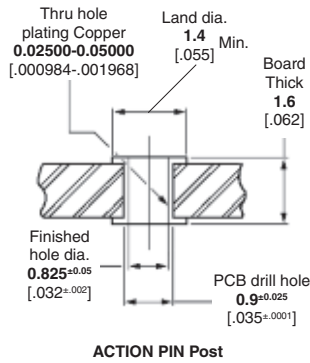

**For Outer Board**

Type	Post Length L	No. of Pos.	Dimensions (See Note.)		Receptacle Assembly Part Nos.
			A	B	
ACTION PIN Post	4.2*	26	35.6 [1.402]	30.48 [1.200]	1-173145-7
		30	40.6 [1.598]	35.56 [1.400]	173145-2
		34	45.7 [1.799]	40.64 [1.600]	1-173145-8
		40	53.3 [2.098]	48.26 [1.900]	173145-3
		50	66.0 [2.598]	60.96 [2.400]	173145-4
		60	78.7 [3.098]	73.66 [2.900]	173145-5
Solder Post	4.2*	26	35.6 [1.402]	30.48 [1.200]	2-173145-8
		30	40.6 [1.598]	35.56 [1.400]	2-173145-4
		34	45.7 [1.799]	40.64 [1.600]	2-173145-9
		40	53.3 [2.098]	48.26 [1.900]	2-173145-5
		50	66.0 [2.598]	60.96 [2.400]	2-173145-6
		60	78.7 [3.098]	73.66 [2.900]	2-173145-7
					3-173145-0**

\*After mounted receptacle assembly is on board, dimension of extrude length from board is 2.6 [.102].  
\*\*Post Length = 17.0 [.669], Blank Width = 0.69 [.027] (see above figure) (finished hole dia. = 1.0 [.039]).

**Note:** All part numbers are RoHS compliant.

**Receptacle Assembly for Inner Board (With 0.55 [.022] Square Post)**



**Material and Finish**

**Housing** — Black glass-filled PBT, 94V-0 rated

**Contacts** — Copper alloy, plated 0.00020 [.000008] gold on contact area and post mating area, gold flash on ACTION PIN tail or 0.000070 [.0000027] tin on solder tail, with entire contact underplated 0.00130 [.000050] nickel

**Application Tooling shown on page 162.**

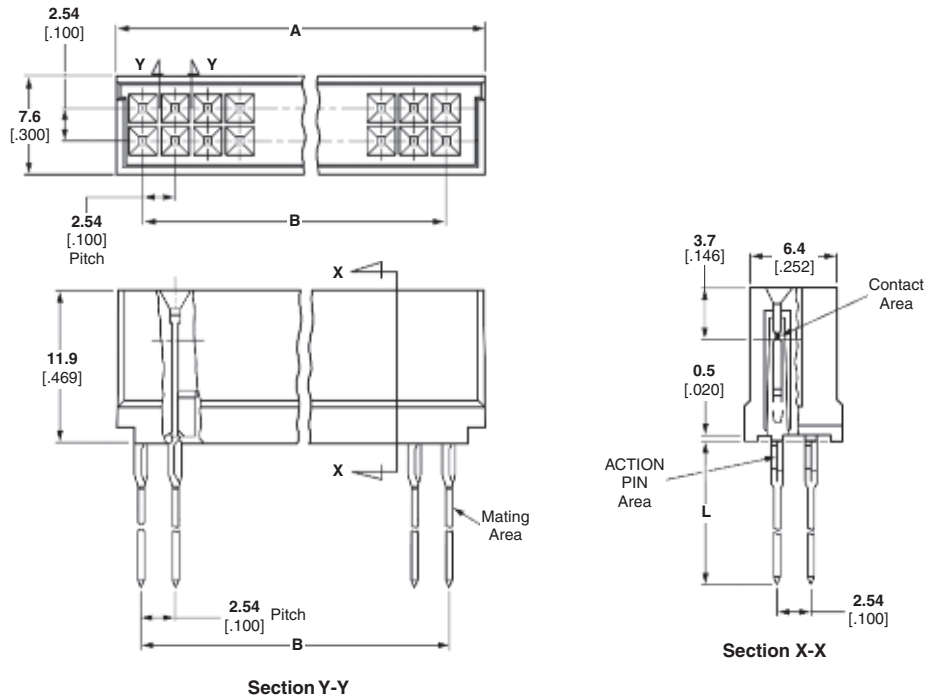

**PC Board Mounting Dimensions**

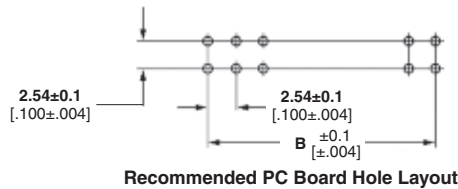
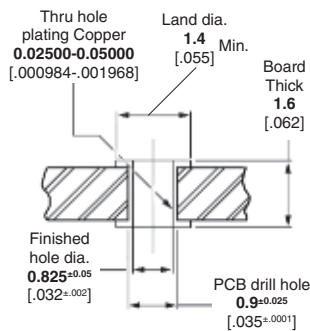

**For Inner Board**

Stacking Dimensions	Post Length L	No. of Pos.	Dimensions (See Note.)		Receptacle Assembly Part Nos.
			A	B	
13.4 [.528]	8.9 .350	30	40.6 [1.598]	35.56 [1.400]	3-173145-2
		34	45.7 [1.799]	40.64 [1.600]	3-173145-7
		40	53.3 [2.098]	48.26 [1.900]	3-173145-3
		50	66.0 [2.598]	60.96 [2.400]	3-173145-1*
		60	78.7 [3.098]	73.66 [2.900]	3-173145-4
	10.9 .429	26	35.6 [1.402]	30.48 [1.200]	1-173145-9
		30	40.6 [1.598]	35.56 [1.400]	173145-7
		34	45.7 [1.799]	40.64 [1.600]	2-173145-0
		40	53.3 [2.098]	48.26 [1.900]	173145-8
		50	66.0 [2.598]	60.96 [2.400]	173145-9
		60	78.7 [3.098]	73.66 [2.900]	1-173145-0

\*Contact area and post mating area: 0.00050 [.000020] min. gold over 0.00130 [.000050] min. nickel plated.

**Note:** All part numbers are RoHS compliant.

Stacking Connectors, Receptacles

5

## Receptacle Assemblies with ACTION PIN Posts (Non-Intermateable with AMPMODU Connectors) (Continued)

### For Inner Board (Continued)

Stacking Dimensions	Post Length L	No. of Pos.	Dimensions (See Note.)		Receptacle Assembly Part Nos.
			A	B	
19.0 [.748]	14.5 [.571]	26	35.6 [1.402]	30.48 [1.200]	4-173145-2
		30	40.6 [1.598]	35.56 [1.400]	3-173145-8
		34	45.7 [1.799]	40.64 [1.600]	4-173145-3
		40	53.3 [2.098]	48.26 [1.900]	3-173145-9
		50	66.0 [2.598]	60.96 [2.400]	4-173145-0
		60	78.7 [3.098]	73.66 [2.900]	4-173145-1
	16.5 [.650]	26	35.6 [1.402]	30.48 [1.200]	2-173145-1
		30	40.6 [1.598]	35.56 [1.400]	1-173145-2
		34	45.7 [1.799]	40.64 [1.600]	2-173145-2
		40	53.3 [2.098]	48.26 [1.900]	1-173145-3
		50	66.0 [2.598]	60.96 [2.400]	1-173145-4
		60	78.7 [3.098]	73.66 [2.900]	1-173145-5

\*Contact area and post mating area: 0.00050 [.000020] min. gold over 0.00130 [.000050] min. nickel plated.

**Note:** All part numbers are RoHS compliant.

## Post Headers with Solder Posts (Non-Intermateable with AMPMODU Connectors)

### Post Header (With 0.55 [.022] Square Post)

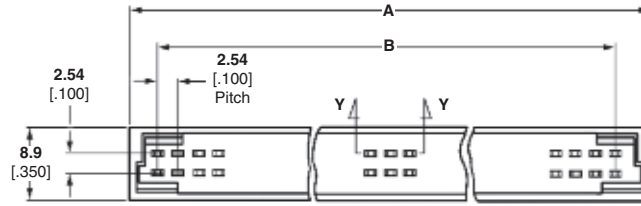

#### Material and Finish

**Housing** — Black glass-filled PBT, 94V-0 rated

**Posts** — Copper alloy, plated 0.00020 [.000008] gold on contact area, 0.000070 [.0000027] min. tin on solder tail, with entire post underplated 0.00130 [.000050] nickel

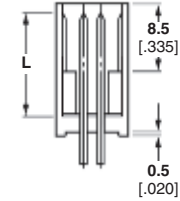
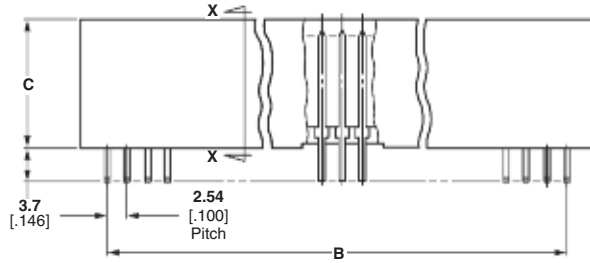

#### PC Board Mounting Dimensions

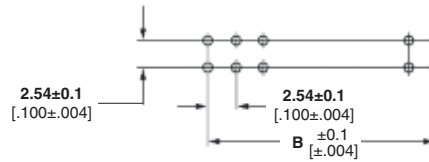
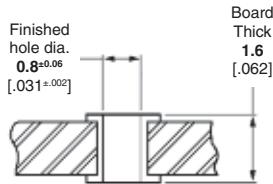

Recommended PC Board Hole Layout

Stacking Dimensions	Post Length L	No. of Pos.	Dimensions (See Note.)			Part Nos. of Post Header Assembly
			A	B	C	
13.9 [.547]	5.8 [.228]	26	38.1 [1.500]	30.48 [1.200]	10.5 [.413]	3-173146-5
		30	43.2 [1.700]	35.56 [1.400]	10.5 [.413]	3-173146-1
		34	48.3 [1.900]	40.64 [1.600]	10.5 [.413]	3-173146-6
		40	55.9 [2.200]	48.26 [1.900]	10.5 [.413]	3-173146-2
		50	68.6 [2.700]	60.96 [2.400]	10.5 [.413]	3-173146-3
		60	81.3 [3.200]	73.66 [2.900]	10.5 [.413]	3-173146-4
	7.8 [.307]	26	38.1 [1.500]	30.48 [1.200]	10.5 [.413]	2-173146-1
		30	43.2 [1.700]	35.56 [1.400]	10.5 [.413]	1-173146-7
		34	48.3 [1.900]	40.64 [1.600]	10.5 [.413]	2-173146-2
		40	55.9 [2.200]	48.26 [1.900]	10.5 [.413]	1-173146-8
		50	68.6 [2.700]	60.96 [2.400]	10.5 [.413]	4-173146-3*
		60	81.3 [3.200]	73.66 [2.900]	10.5 [.413]	1-173146-9
		60	81.3 [3.200]	73.66 [2.900]	10.5 [.413]	2-173146-0

\*Contact mating area: 0.00050 [.000020] min. gold over 0.00130 [.000050] min. nickel plated.

**Note:** All part numbers are RoHS compliant.



**Post Headers with Solder Posts  
(Non-Intermateable with AMPMODU Connectors)** (Continued)

Stacking Dimensions	Post Length L	No. of Pos.	Dimensions (See Note.)			Part Nos. of Post Header Assembly
			A	B	C	
19.5 [.768]	11.4 [.449]	26	38.1 [1.500]	30.48 [1.200]	16.1 [.634]	4-173146-1
		30	43.2 [1.700]	35.56 [1.400]	16.1 [.634]	3-173146-7
		34	48.3 [1.900]	40.64 [1.600]	16.1 [.634]	4-173146-2
		40	55.9 [2.200]	48.26 [1.900]	16.1 [.634]	3-173146-8
		50	68.6 [2.700]	60.96 [2.400]	16.1 [.634]	3-173146-9
		60	81.3 [3.200]	73.66 [2.900]	16.1 [.634]	4-173146-0
	13.4 [.528]	26	38.1 [1.500]	30.48 [1.200]	16.1 [.634]	2-173146-8
		30	43.2 [1.700]	35.56 [1.400]	16.1 [.634]	2-173146-4
		34	48.3 [1.900]	40.64 [1.600]	16.1 [.634]	2-173146-9
		40	55.9 [2.200]	48.26 [1.900]	16.1 [.634]	2-173146-5
		50	68.6 [2.700]	60.96 [2.400]	16.1 [.634]	2-173146-6
		60	81.3 [3.200]	73.66 [2.900]	16.1 [.634]	2-173146-7

\*Contact mating area: 0.00050 [.000020] min. gold over 0.00130 [.000050] min. nickel plated.

**Note:** All part numbers are RoHS compliant.

## Application Tooling for ACTION PIN Stacking Connectors

### Mini-Press



No. of Pos.	Part No.
40	1-758030-1
50	1-758030-2
60	1-758030-3

The part numbers above include the Mini-Press unit, insertion support plate and press-fit jig.

#### Mini-Press Unit Part No. 1-758030-3

When ordering a press-fit jig only, consult the table below.

#### Press-fit Jig (separate order)

No. of Pos.	Part No.
26	907459-1
30	907459-2
34	907459-3
40	907459-4
50	907459-5
60	907459-6

Also, optional insertion support plates are obtainable by separate order to meet your specific requirements for improved board handling.

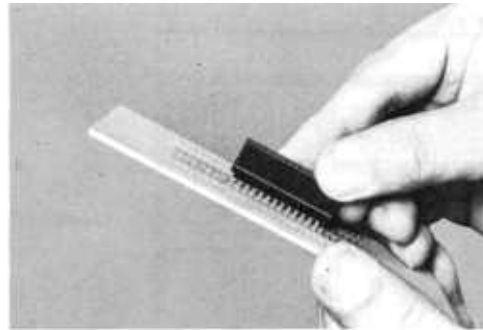

1. Insert connector into the board tentatively (Be sure that connector is in the right direction).

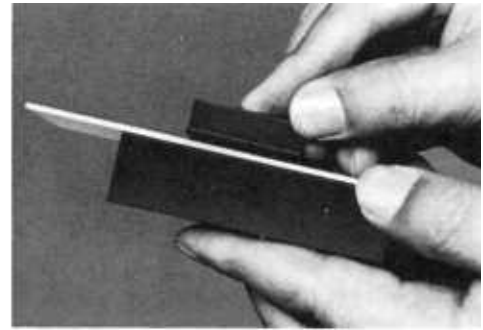

2. Attach insertion support plate to the leg portion of connector from below.



3. Set insertion support plate in place by butting it against Mini-Press platform.

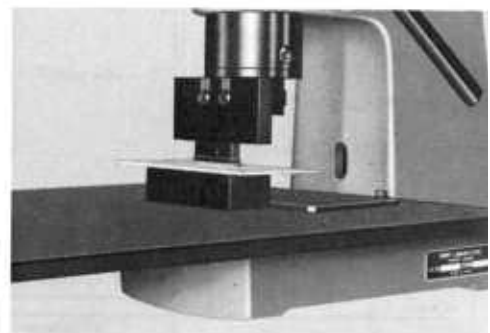

4. By pressing Mini-Press handle down, rest the press-fit jig against connector.

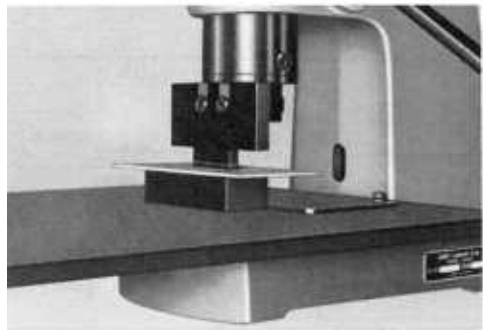

5. Press handle down gently and insert connector into the board.

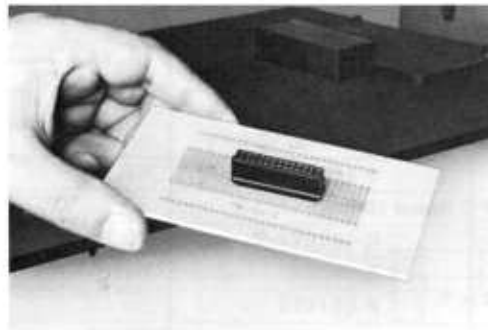

6. Now connector has been mounted to the board securely.



Insertion Support Unit  
(Option)



**Note:** All part numbers are RoHS compliant.

## .025 [0.64] Square Posts

### Bandolier Posts (Uninsulated)

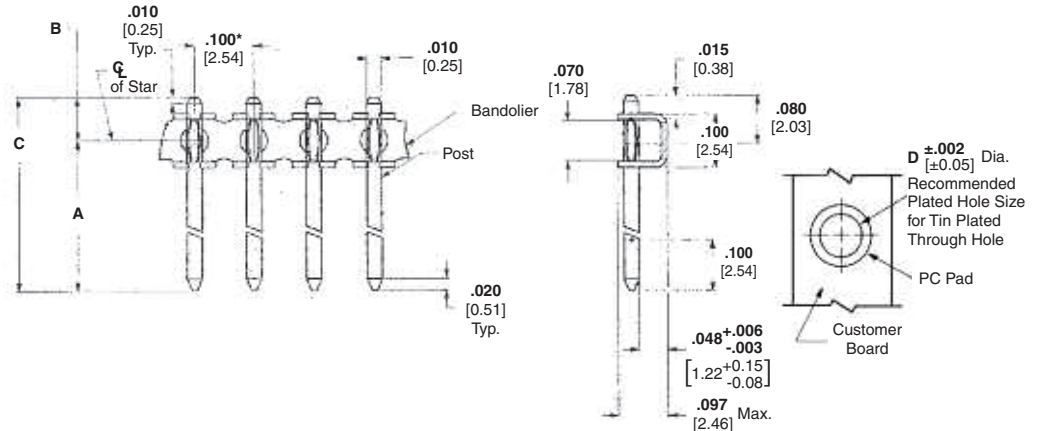

#### Material and Finish

**Bandolier** — Brass

**Posts** — Phosphor bronze, plated as follows:

**Plating A** — Duplex plated .000030 [0.00076] gold on contact area, .000100-.000200 [0.00254-0.00508] tin on solder area, with entire post underplated. .000050 [0.00127] nickel

**Plating B** — Duplex plated .000015 [0.00038] gold on contact area, .000100-.000200 [0.00254-0.00508] tin on solder area, with entire post underplated. .000050 [0.00127] nickel

**Plating C** — .000100-.000200 [0.00254-0.00508] tin over .000050 [0.00127] nickel on entire post

#### Related Product Data

**Mateable Connectors** — Refer to the Mating Post Selection Guide — page 90

#### Accessories

**End Shrouds** — page 203

**Application Tooling** — page 153

#### Technical Documents

See mating connector for applicable product and application specifications.

### Strip Form Posts (Uninsulated)

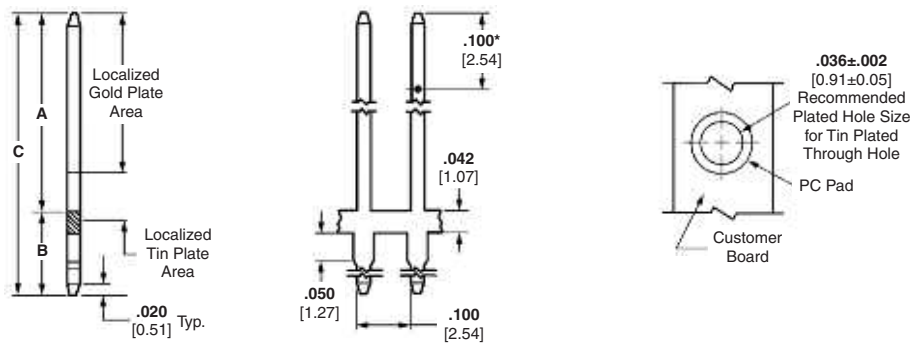

#### Material and Finish

**Posts** — Phosphor bronze, plated as follows:

**Plating A** — Duplex plated .000030 [0.00076] gold on contact area, .000100-.000200 [0.00254-0.00508] tin on solder area, with entire post underplated. .000050 [0.00127] nickel

**Plating B** — Duplex plated .000015 [0.00038] gold on contact area, .000100-.000200 [0.00254-0.00508] tin on solder area, with entire post underplated. .000050 [0.00127] nickel

**Plating C** — .000030 [0.00076] gold over .000050 [0.00127] nickel on entire post

**Plating D** — .000100-.000200 [0.00254-0.00508] tin over .000050 [0.00127] nickel on entire post

Dimensions				Post Plating/Part Nos.			Bandolier Insertion Head
A	B	C	D	Plating A	Plating B	Plating C	
.353 [8.97]	.071 [1.80]	.424 [10.77]	.034 [0.86]	5-103577-1	6-103577-3	5-103577-7	904592-1
.318 [8.08]	.071 [1.80]	.389 [9.88]	.034 [0.86]	5-103577-3	6-103577-5	5-103577-9	904591-1
.270 [6.86]	.071 [1.80]	.341 [8.66]	.034 [0.86]	5-103577-5	6-103577-7	6-103577-1	904590-1
.183 [4.65]	.097 [2.46]	.280 [7.11]	.031 [0.79]	5-146079-1	—	—	—
				—	—	6-146079-3	—

- Notes:** 1. Posts can be applied using **Hand Tool 91419-1**. \*Point of measurement for plating thickness.  
 2. Approximate posts per reel—30,000.  
 3. The Bandolier Insertion Head can be used on the Comp-U-Sertor II machine or the Modular Insertion System Bench machine (see page 153).  
 4. For PCB finishes other than tin, contact TE.

Dimensions			Post Plating/Part Nos.				Post/Tab Insertion Head
A	B	C	Plating A	Plating B	Plating C	Plating D	
.210 [5.33]	.227 [5.77]	.437 [11.10]	—	—	87878-6	1-87022-4	—
.278 [7.06]	.165 [4.19]	.443 [11.25]	5-87623-1	5-87623-4	87022-1	1-87022-0	904507-1
.278 [7.06]	.284 [7.21]	.562 [14.27]	—	—	1-87022-3	—	—
.278 [7.06]	.738 [18.75]	1.016 [25.81]	—	—	87022-2	87022-4	—
.318 [8.08]	.165 [4.19]	.483 [14.27]	—	—	4-87022-1	4-87022-3	—

- Notes:** 1. Approximate Posts per reel—20,000. \*Point of measurement for plating thickness.  
 2. Other post lengths are available, consult TE.  
 3. The Post/Tab Insertion Head can be used on the Comp-U-Sertor II machine or the Modular Insertion System Bench machine (see page 153).  
 4. For PCB finishes other than tin, contact TE.

**Note:** All part numbers are RoHS compliant.

## AMPMODU .025 [0.64] Square Continuous Posts

### Features of .025 [0.64] Square Continuous Posts

- Brass drawn wire for posts
- .400 to 1.000 [10.16 to 25.40] overall pin length (.010 [0.25] increments)
- Plating Options:
  - Tin
  - 15µ in. gold
  - 30µ in. gold
- Star feature also available

### Benefits

- Less expensive than bandolier style posts
- Can be placed on printed circuit boards at any desired centerline
- Less scrap material (no carrier strip)

**Technical Documents** — page 276  
**Application Specification**  
 114-13011



TE now offers AMPMODU .025 [0.64] Square Continuous Posts. These posts can be used instead of the original posts that come on a bandolier style carrier strip. These posts are on a reel, but the posts are 'notched' at the desired length (no carrier strip is needed). This feature allows more versatility by providing post lengths from .400 to 1.000 [10.16 to 25.40], available in increments of .010 [0.25].

The posts are brass drawn wire and are inserted into a printed circuit board via application tooling at any centerline configuration. They can be used for wire wrap applications or mated to a receptacle.

The current rating is 3 amps. The posts are available plated with tin, 15µ in. gold, or 30µ in. gold. Other platings are available upon request.

TE application tooling is a modular head (Part Number 904641-1) placed on the Modular Insertion System Bench Machine (Part Number 217600-1.)

**Note:** All part numbers are RoHS compliant.



## AMPMODU .045 [1.14] Square Continuous Posts

### Features of .045 [1.14] Square Continuous Posts

- Brass drawn wire for posts
- .400 to 1.000 [10.16 to 25.40] overall pin length (.010 [0.25] increments)
- Plating Options:
  - Tin
  - 15µ in. gold
  - 30µ in. gold
- Star feature also available

### Benefits

- Less expensive than bandolier style posts
- Can be placed on printed circuit boards at any desired centerline
- Less scrap material (no carrier strip)

**Technical Documents** — page 276  
**Application Specification**  
 114-13011

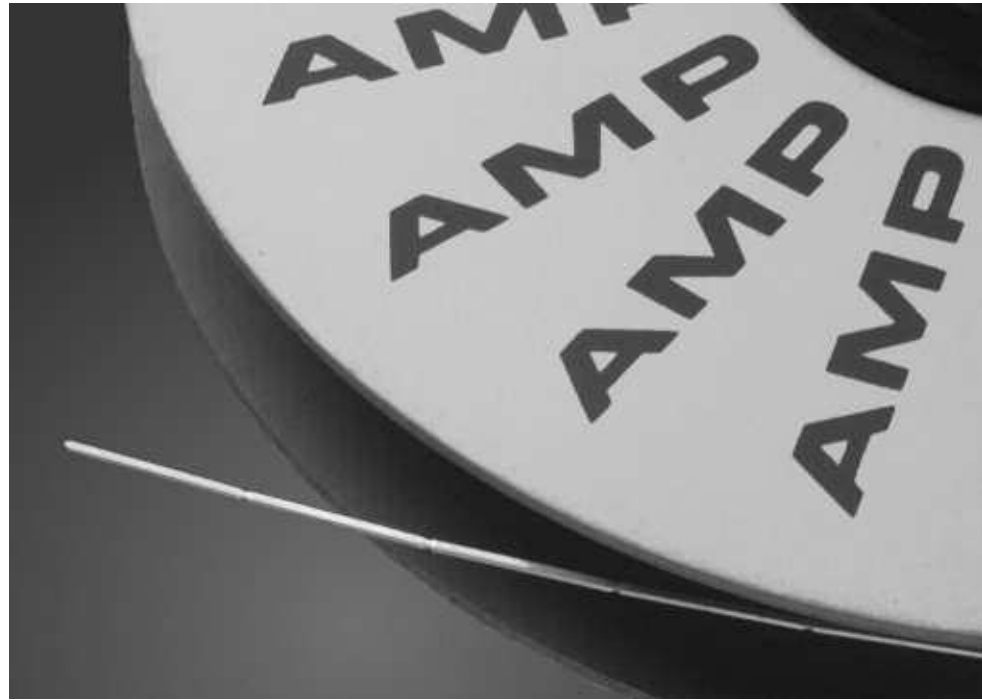

TE now offers AMPMODU .045 [1.14] Square Continuous Posts. These posts can be used instead of the original posts that come on a bandolier style carrier strip. These posts are on a reel, but the posts are 'notched' at the desired length (no carrier strip is needed). This feature allows more versatility by providing post lengths from .400 to 1.000 [10.16 to 25.40], available in increments of .010 [0.25].

The posts are brass drawn wire and are inserted into a printed circuit board via application tooling at any centerline configuration. They can be used for wire wrap applications or mated to a receptacle.

Potential industries include: building systems, commercial/home equipment, household appliances, home power tools and equipment.

The current rating is 7 amps. The posts are available plated with tin, 15µ in. gold, or 30µ in. gold. Other platings are available upon request.

TE application tooling is a modular head (Part Number 904640-1) placed on the Modular Insertion System Bench Machine (Part Number 217600-1.)

**Note:** All part numbers are RoHS compliant.



## Receptacle Assemblies, Horizontal Mount

### Product Facts

- All receptacle assemblies are end stackable
- Contact design employs dual cantilever beams with built-in anti-overstress feature
- Closed entry housings help prevent post stubbing
- Wide range of sizes available
- Other versions available upon request
- Housings made of high temperature, surface mount compatible thermoplastic material, 94V-0 rated
- Duplex gold and matte tin plated contacts have full nickel underplate
- Housings feature PC board standoffs
- Solder tails accommodate a PC board thickness of .062 [1.57]
- Recognized under the Component Program of Underwriters Laboratories Inc., File No. E28476
- Certified by Canadian Standards Association, File No. LR 7189

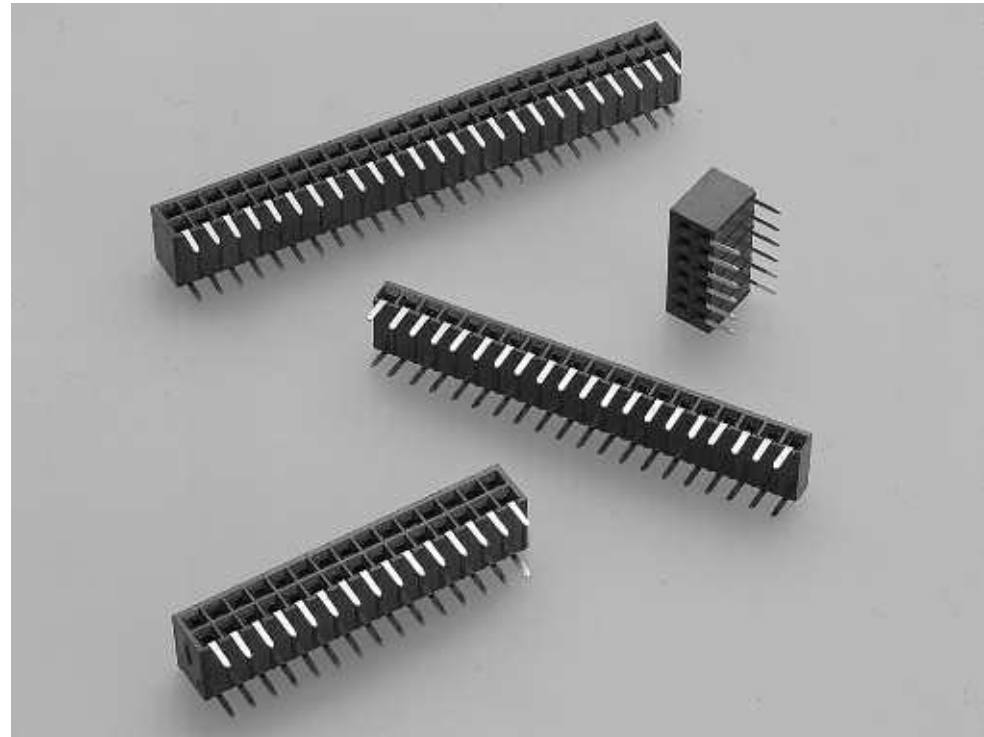

Horizontal Mount receptacle assemblies are designed to reliably and economically meet the packaging and interconnection requirements of today's electronics industry, generally for applications using the mother/daughter board arrangement.

This product line is offered in both single and double row configurations. The .100 [2.54] centerline

assemblies are available in a wide range of position sizes. They have end stacking capability which gives the added advantage of flexibility.

The housings are made of high temperature, surface mount compatible thermoplastic material that is 94V-0 rated. Contacts are phosphor bronze, fully underplated with nickel to help prevent corrosion and are available in three plating options.

The receptacle contact is an established proven design with a fully enclosed, one-piece "box" to protect the contact area. In addition, the receptacle contact has dual cantilever beams with a built-in anti-overstress feature. Standard solder tails accommodate a board thickness of .062 [1.57].

### Performance Characteristics

#### Mechanical Characteristics

**Mating Force** — 6.0 oz. [1.67N] per contact (max.)

**Unmating Force** — .75 oz. [0.21N] per contact (min.) during third mating cycle

**Durability** — 200 cycles

#### Environmental Characteristics

**Operating Temperature** — -65°C to +125°C

#### Electrical Characteristics

**Current Rating** — 3.0 amperes (max.) for single contact; 2.0 amperes (max.) per contact when connector is fully energized

**Contact Resistance** — 12 milliohms (max.)

**Insulation Resistance** — 5000 megohms (min.) between adjacent contacts

**Dielectric Withstanding Voltage (at sea level)** — 750 V rms



## Mod II Receptacle Assemblies, Single-Row, .100 [2.54] Centerline

**Closed Entry, End Stackable, Short Point-of-Contact, with Standoffs**



### Material and Finish

**Housing** — Glass-filled thermoplastic, black, 94V-0 rated

**Contacts** — Phosphor bronze, plated as follows:

**Plating A** — Duplex .000030 [0.00076] gold on contact area, .000150-.000300 [0.00381-0.00762] matte tin on solder area all over .000050 [0.00127] nickel

**Plating B** — Duplex .000010 [0.000254] gold on contact area, .000150-.000300 [0.00381-0.00762] matte tin on solder area all over .000050 [0.00127] nickel

**Plating C** — .000150-.000300 [0.00381-0.00762] matte tin on solder leads, all over .000050 [0.00127] nickel

### Related Product Data

**Mateable Headers** — Refer to the Mating Post Selection Guide — page 90

**Performance Characteristics** — page 168

**Technical Documents** — page 276

**Product Specification**  
108-25026

**Application Specification**  
114-25018

**Additional receptacle assembly sizes are available; minimum order quantities may apply. Consult TE.**

### Keying Plug



**Part No. 86286-1**  
(Plugs into receptacle contact)

**Material** — Natural color nylon

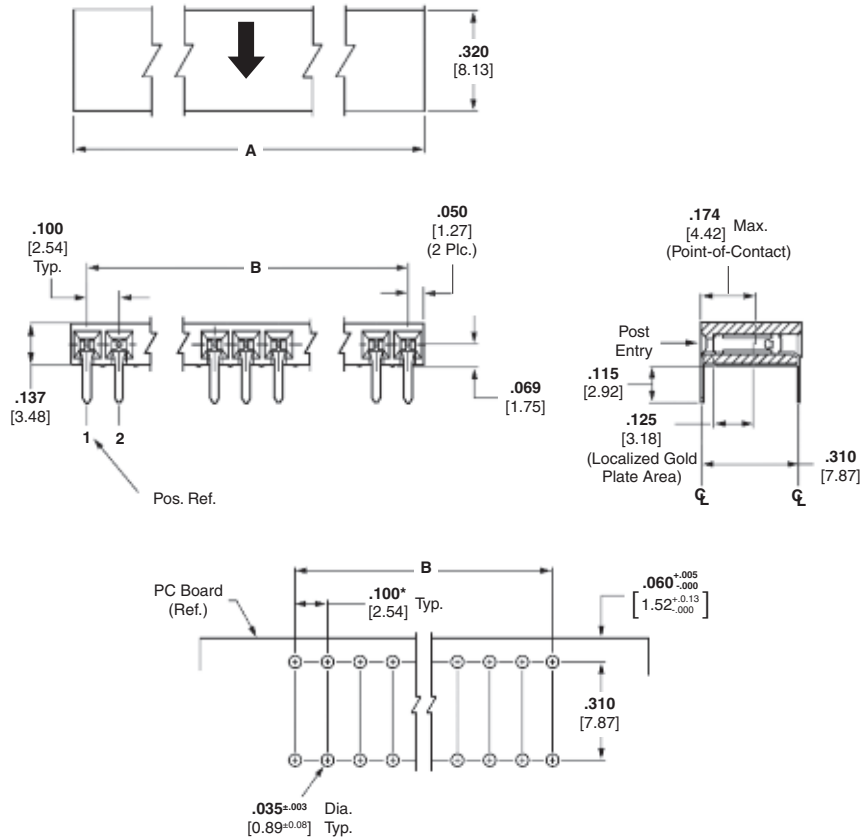

**Recommended PC Board Hole Layout**  
(for .062 [1.57] thick PC board)

\*±.003 [±0.08] tolerances not to accumulate within one connector pattern.

No. of Pos.	Dimensions		Contact Plating/Part Nos.		
	A	B	Plating A	Plating B	Plating C
2	.200 [5.08]	.100 [2.54]	5535676-1	5146139-1	5535677-1
3	.300 [7.62]	.200 [5.08]	5535676-2	5146139-2	5535677-2
4	.400 [10.16]	.300 [7.62]	5535676-3	5146139-3	5535677-3
5	.500 [12.70]	.400 [10.16]	5535676-4	5146139-4	5535677-4
6	.600 [15.24]	.500 [12.70]	5535676-5	5146139-5	5535677-5
7	.700 [17.78]	.600 [15.24]	5535676-6	5146139-6	5535677-6
8	.800 [20.32]	.700 [17.78]	5535676-7	5146139-7	5535677-7
9	.900 [22.86]	.800 [20.32]	5535676-8	5146139-8	5535677-8
10	1.000 [25.40]	.900 [22.86]	5535676-9	5146139-9	5535677-9
11	1.100 [27.94]	1.000 [25.40]	1-5535676-0	1-5146139-0	1-5535677-0
12	1.200 [30.48]	1.100 [27.94]	1-5535676-1	1-5146139-1	1-5535677-1
13	1.300 [33.02]	1.200 [30.48]	1-5535676-2	1-5146139-2	1-5535677-2
14	1.400 [35.56]	1.300 [33.02]	1-5535676-3	1-5146139-3	1-5535677-3
15	1.500 [38.10]	1.400 [35.56]	1-5535676-4	1-5146139-4	1-5535677-4
16	1.600 [40.64]	1.500 [38.10]	1-5535676-5	1-5146139-5	1-5535677-5
17	1.700 [43.18]	1.600 [40.64]	1-5535676-6	1-5146139-6	1-5535677-6
18	1.800 [45.72]	1.700 [43.18]	1-5535676-7	1-5146139-7	1-5535677-7
19	1.900 [48.26]	1.800 [45.72]	1-5535676-8	1-5146139-8	1-5535677-8
20	2.000 [50.80]	1.900 [48.26]	1-5535676-9	1-5146139-9	1-5535677-9
30	3.000 [76.20]	2.900 [73.66]	2-5535676-9	2-5146139-9	2-5535677-9
40	4.000 [101.60]	3.900 [99.06]	3-5535676-9	3-5146139-9	3-5535677-9

**Note:** 1. TE recommends mating gold or duplex plated headers with duplex plated receptacle assemblies.

**Note:** All part numbers are RoHS compliant.

## Mod II Receptacle Assemblies, Double-Row, .100 x .100 [2.54 x 2.54] Centerlines

**Closed Entry, End Stackable, Short Point-of-Contact, with Standoffs**

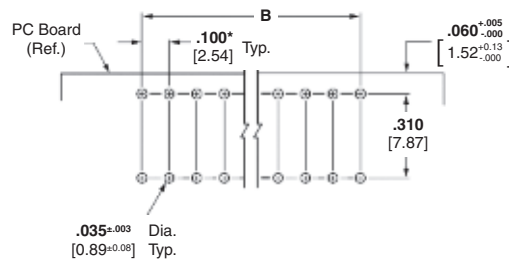
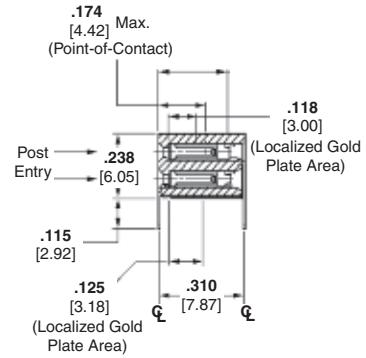
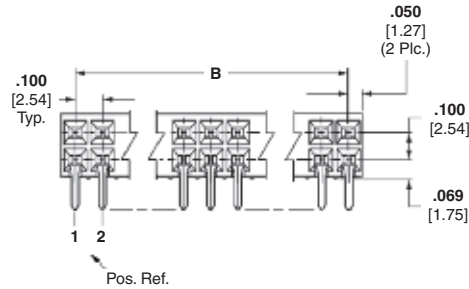
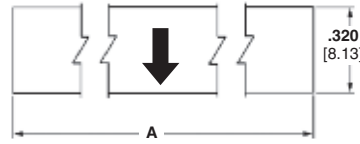
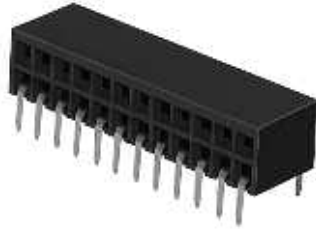

**Recommended PC Board Hole Layout (for .062 [1.57] thick PC board)**

\*±.003 [±0.08] tolerances not to accumulate within one connector pattern.

### Material and Finish

**Housing** — Glass-filled thermoplastic, black, 94V-0 rated

**Contacts** — Phosphor bronze, plated as follows:

**Plating A** — Duplex .000030 [0.00076] gold on contact area, .000150-.000300 [0.00381-0.00762] matte tin on solder area all over .000050 [0.00127] nickel

**Plating B** — Duplex .000010 [0.000254] gold on contact area, .000150-.000300 [0.00381-0.00762] matte tin on solder area all over .000050 [0.00127] nickel

**Plating C** — .000150-.000300 [0.00381-0.00762] matte tin on solder leads, all over .000050 [0.00127] nickel

### Related Product Data

**Mateable Headers** — Refer to the Mating Post Selection Guide — page 90

**Performance Characteristics** — page 168

**Technical Documents** — page 276

**Product Specification** 108-25026

**Application Specification** 114-25018

**Additional receptacle assembly sizes are available; minimum order quantities may apply. Consult TE.**

No. of Pos.	Dimensions		Contact Plating/Part Nos.		
	A	B	Plating A	Plating B	Plating C
4	.200 [5.08]	.100 [2.54]	6-5535512-1	5146140-1	6-5102084-4
6	.300 [7.62]	.200 [5.08]	6-5535512-2	5146140-2	6-5102084-3
8	.400 [10.16]	.300 [7.62]	6-5535512-3	5146140-3	6-5102084-2
10	.500 [12.70]	.400 [10.16]	6-5535512-4	5146140-4	6-5102084-1
12	.600 [15.24]	.500 [12.70]	5535512-1	5146140-5	6-5102084-0
14	.700 [17.78]	.600 [15.24]	1-5535512-7	5146140-6	5-5102084-9
16	.800 [20.32]	.700 [17.78]	1-5535512-8	5146140-7	5-5102084-8
18	.900 [22.86]	.800 [20.32]	1-5535512-6	5146140-8	5-5102084-7
20	1.000 [25.40]	.900 [22.86]	5535512-2	5146140-9	5-5102084-6
22	1.100 [27.94]	1.000 [25.40]	1-5535512-9	1-5146140-0	5-5102084-5
24	1.200 [30.48]	1.100 [27.94]	5535512-3	1-5146140-1	5-5102084-4
26	1.300 [33.02]	1.200 [30.48]	2-5535512-0	1-5146140-2	5-5102084-3
28	1.400 [35.56]	1.300 [33.02]	2-5535512-1	1-5146140-3	5-5102084-2
30	1.500 [38.10]	1.400 [35.56]	2-5535512-2	1-5146140-4	5-5102084-1
32	1.600 [40.64]	1.500 [38.10]	2-5535512-3	1-5146140-5	5-5102084-0
34	1.700 [43.18]	1.600 [40.64]	5535512-4	1-5146140-6	4-5102084-9
36	1.800 [45.72]	1.700 [43.18]	5535512-5	1-5146140-7	4-5102084-8
38	1.900 [48.26]	1.800 [45.72]	2-5535512-4	1-5146140-8	4-5102084-7
40	2.000 [50.80]	1.900 [48.26]	2-5535512-5	1-5146140-9	4-5102084-6
50	2.500 [63.50]	2.400 [60.96]	5535512-7	2-5146140-0	4-5102084-1
60	3.000 [76.20]	2.900 [73.66]	3-5535512-0	2-5146140-1	3-5102084-6

**Notes:** 1. TE recommends mating gold or duplex plated headers with duplex plated receptacle assemblies.  
2. .256 [6.50] minimum positive pin stop to prevent shorting between row.

**Note:** All part numbers are RoHS compliant.

## Mod II Surface Mount Horizontal Receptacle Assemblies, .100 x .100 [2.54 x 2.54] Centerline

### Product Facts

- Surface mount leads
- All receptacle assemblies are end stackable
- Contact design employs dual cantilever beams with built-in anti-overstress feature
- Closed entry housings help prevent post stubbing
- Housings made of high temperature, surface mount compatible thermoplastic material, 94 V-0 rated
- Duplex gold and matte tin plated contacts have full nickel underplate
- Housings feature PC board standoffs
- Recognized under the Component Program of Underwriters Laboratories Inc., File No. E28476 
- Certified by Canadian Standards Association, File No. LR 7189 

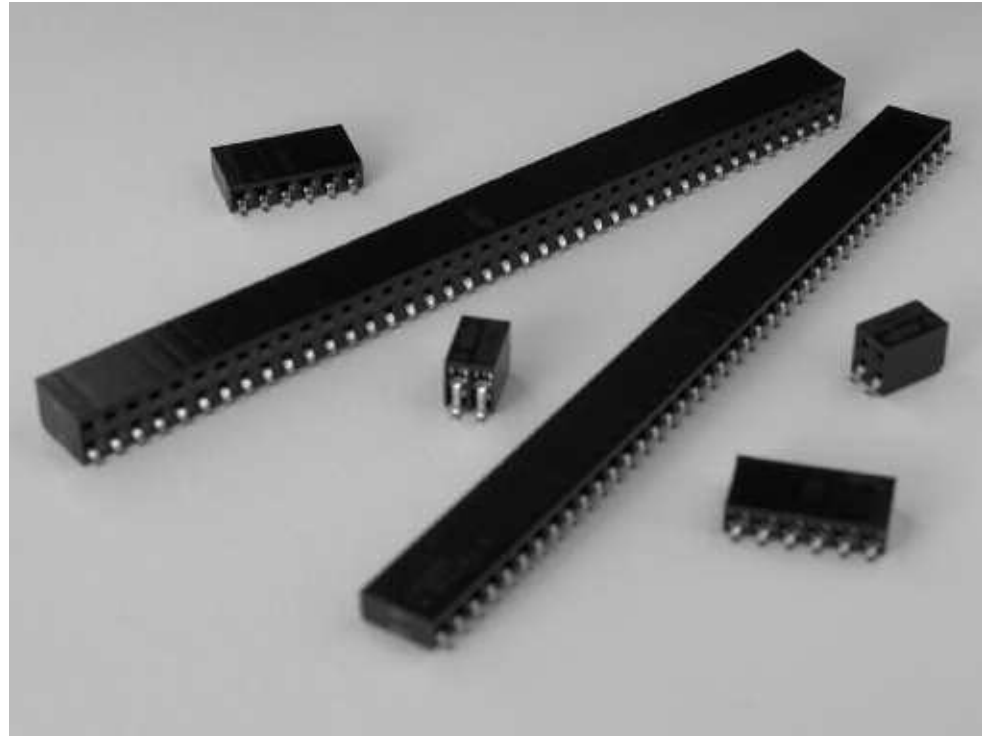

Horizontal surface mount receptacle assemblies are designed to reliably and economically meet the packaging and interconnection requirements of today's electronics industry as process technologies evolve from wave soldering to surface mount processing.

This broad product line is offered in both single and

double row configurations. The .100 [2.54] centerline assemblies are available in 2-40 (single row) positions and 4-80 (double row) positions. Housings are end stackable, which gives the advantage of added flexibility.

The housings are made of high temperature material that is 94V-0 rated. Contacts

are phosphor bronze, fully underplated with nickel to help prevent corrosion and are available in three plating options.

The receptacle contact is an established proven design, with a fully enclosed one-piece "box" to protect the contact beams with built-in anti-overstress feature.

### Performance Characteristics

#### Mechanical Characteristics

**Mating Force** — 6.0 oz. [1.67N] per contact (max.)

**Unmating Force** — .75 oz. [0.21N] per contact (min.) during third mating cycle

**Durability** — 200 cycles

#### Environmental Characteristics

**Operating Temperature** — -65°C to +125°C

#### Electrical Characteristics

**Current Rating** — 3.0 amperes (max.) for single contact; 2.0 amperes (max.) per contact when connector is fully energized

**Contact Resistance** — 12 milliohms (max.)

**Insulation Resistance** — 5000 megohms (min.) between adjacent contacts

**Dielectric Withstanding Voltage (at sea level)** — 750 V rms

## Mod II Receptacle Assemblies, Single-Row, Surface Mount .100 [2.54] Centerline

**Closed Entry, End Stackable,  
Short Point-of-Contact,  
with Standoffs**



### Material and Finish

**Housing** — Glass-filled thermoplastic, black, 94V-0 rated

**Contacts** — Phosphor bronze, plated as follows:

**Plating A** — Duplex .000030 [0.00076] gold on contact area, .000150-.000300 [0.00381-0.00762] matte tin on solder area all over .000050 [0.00127] nickel

**Plating B** — Duplex .000010 [0.000254] gold on contact area, .000150-.000300 [0.00381-0.00762] matte tin on solder area all over .000050 [0.00127] nickel

**Plating C** — .000150-.000300 [0.00381-0.00762] matte tin on solder leads, all over .000050 [0.00127] nickel

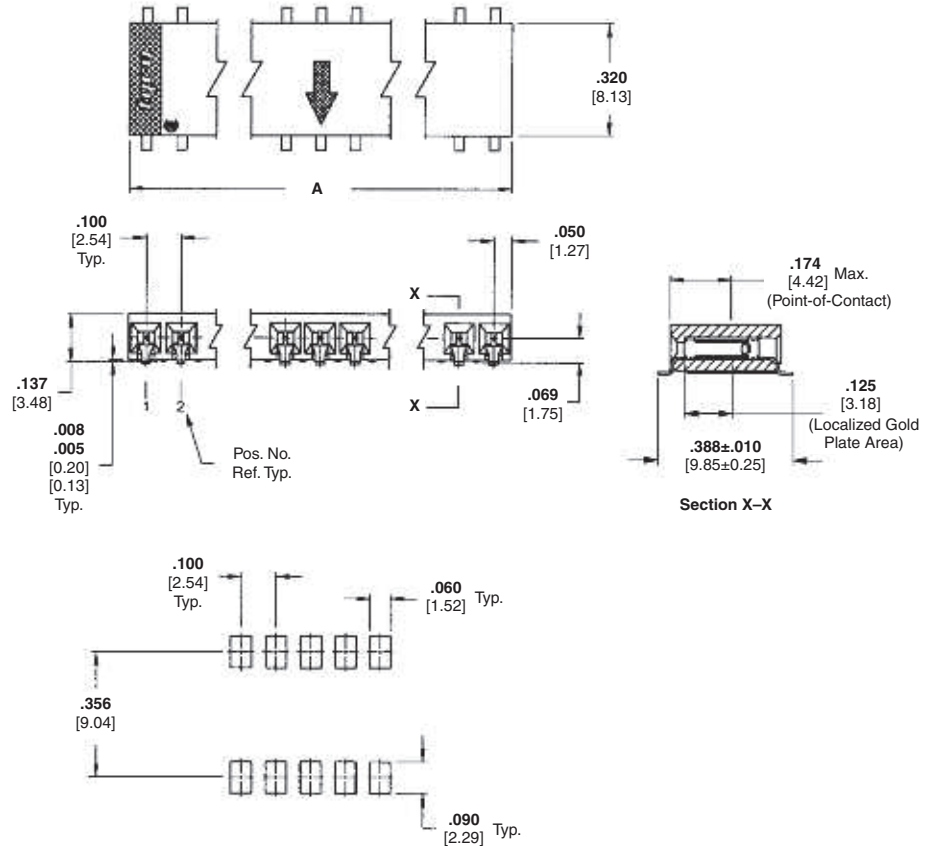

**Recommended Etched Circuit Layout**  
(for .040 [1.02] min. thick PC Board;  
.008 [0.20] thick stencil)

### Related Product Data

**Mateable Headers** — Refer to the Mating Post Selection Guide — page 90

**Performance Characteristics** — page 171

**Technical Documents** — page 276

**Product Specification**  
108-25026

**Application Specification**  
114-25018

**Additional receptacle assembly sizes are available; minimum order quantities may apply. Consult TE.**

### Keying Plug



**Part No. 86286-1**  
(Plugs into receptacle contact)

**Material** — Natural color nylon

**Note:** All part numbers are RoHS compliant.

No. of Pos.	Dimension A	Contact Plating/Part Nos.		
		Plating A	Plating B	Plating C
2	.200 [5.08]	5147721-1	5147732-1	5147733-1
3	.300 [7.62]	5147721-2	5147732-2	5147733-2
4	.400 [10.16]	5147721-3	5147732-3	5147733-3
5	.500 [12.70]	5147721-4	5147732-4	5147733-4
6	.600 [15.24]	5147721-5	5147732-5	5147733-5
7	.700 [17.78]	5147721-6	5147732-6	5147733-6
8	.800 [20.32]	5147721-7	5147732-7	5147733-7
9	.900 [22.86]	5147721-8	5147732-8	5147733-8
10	1.000 [25.40]	5147721-9	5147732-9	5147733-9
11	1.100 [27.94]	1-5147721-0	1-5147732-0	1-5147733-0
12	1.200 [30.48]	1-5147721-1	1-5147732-1	1-5147733-1
13	1.300 [33.02]	1-5147721-2	1-5147732-2	1-5147733-2
14	1.400 [35.56]	1-5147721-3	1-5147732-3	1-5147733-3
15	1.500 [38.10]	1-5147721-4	1-5147732-4	1-5147733-4
16	1.600 [40.64]	1-5147721-5	1-5147732-5	1-5147733-5
17	1.700 [43.18]	1-5147721-6	1-5147732-6	1-5147733-6
18	1.800 [45.72]	1-5147721-7	1-5147732-7	1-5147733-7
19	1.900 [48.26]	1-5147721-8	1-5147732-8	1-5147733-8
20	2.000 [50.80]	1-5147721-9	1-5147732-9	1-5147733-9
30	3.000 [76.20]	2-5147721-9	2-5147732-9	2-5147733-9
40	4.000 [101.60]	3-5147721-9	3-5147732-9	3-5147733-9

## Mod II Receptacle Assemblies, Double-Row, Surface Mount .100 [2.54] Centerline

**Closed Entry, End Stackable,  
Short Point-of-Contact,  
with Standoffs**



### Material and Finish

**Housing** — Glass-filled thermoplastic, black, 94V-0 rated

**Contacts** — Phosphor bronze, plated as follows:

**Plating A** — Duplex .000030 [0.00076] gold on contact area, .000150-.000300 [0.00381-0.00762] matte tin on solder area all over .000050 [0.00127] nickel

**Plating B** — Duplex .000010 [0.000254] gold on contact area, .000150-.000300 [0.00381-0.00762] matte tin on solder area all over .000050 [0.00127] nickel

**Plating C** — .000150-.000300 [0.00381-0.00762] matte tin on solder leads, all over .000050 [0.00127] nickel

### Related Product Data

**Mateable Headers** — Refer to the Mating Post Selection Guide — page 90

**Performance Characteristics** — page 171

**Technical Documents** — page 276

**Product Specification**  
108-25026

**Application Specification**  
114-25018

**Additional receptacle assembly sizes are available; minimum order quantities may apply. Consult TE.**

**Note:** All part numbers are RoHS compliant.

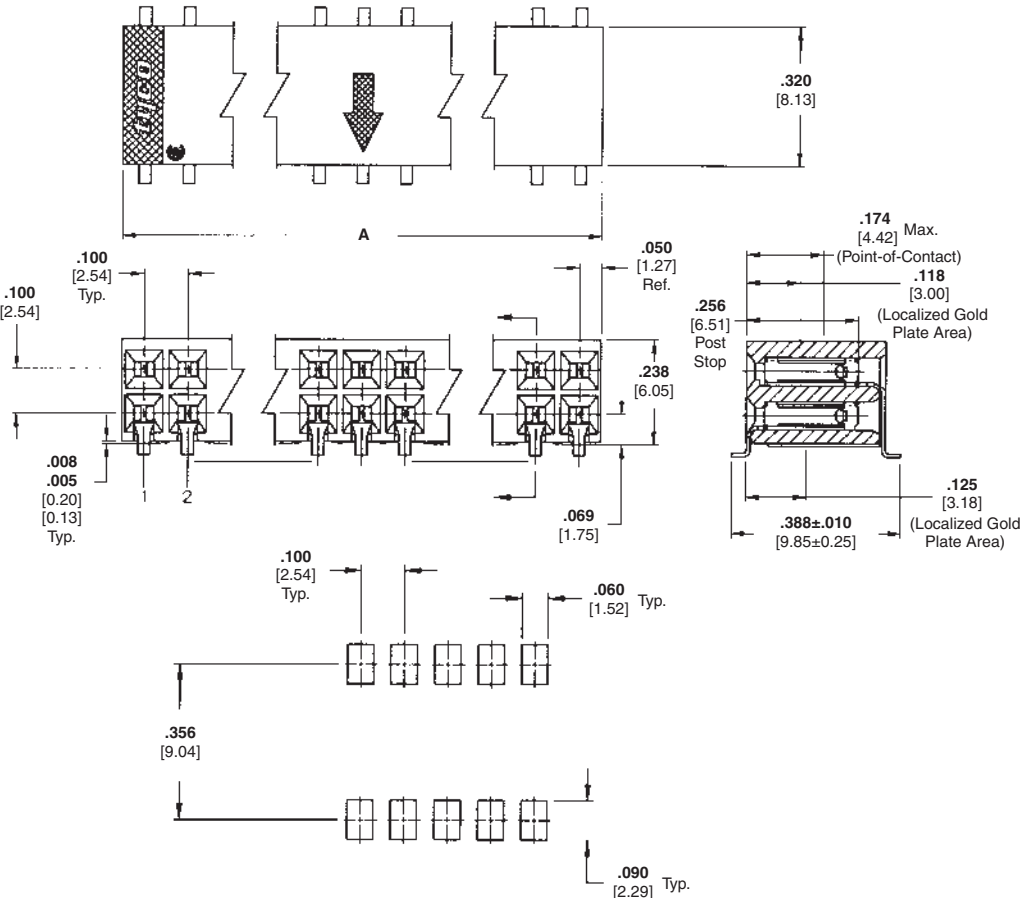



**Recommended Etched Circuit Layout**  
(for .040 [1.02] min thick PC Board;  
.008 [0.20] thick stencil)

No. of Pos.	Dimension A	Contact Plating/Part Nos.		
		Plating A	Plating B	Plating C
4	.200 [5.08]	5147722-1	5147734-1	5147735-1
6	.300 [7.62]	5147722-2	5147734-2	5147735-2
8	.400 [10.16]	5147722-3	5147734-3	5147735-3
10	.500 [12.70]	5147722-4	5147734-4	5147735-4
12	.600 [15.24]	5147722-5	5147734-5	5147735-5
14	.700 [17.78]	5147722-6	5147734-6	5147735-6
16	.800 [20.32]	5147722-7	5147734-7	5147735-7
18	.900 [22.86]	5147722-8	5147734-8	5147735-8
20	1.000 [25.40]	5147722-9	5147734-9	5147735-9
22	1.100 [27.94]	1-5147722-0	1-5147734-0	1-5147735-0
24	1.200 [30.48]	1-5147722-1	1-5147734-1	1-5147735-1
26	1.300 [33.02]	1-5147722-2	1-5147734-2	1-5147735-2
28	1.400 [35.56]	1-5147722-3	1-5147734-3	1-5147735-3
30	1.500 [38.10]	1-5147722-4	1-5147734-4	1-5147735-4
32	1.600 [40.64]	1-5147722-5	1-5147734-5	1-5147735-5
34	1.700 [43.18]	1-5147722-6	1-5147734-6	1-5147735-6
36	1.800 [45.72]	1-5147722-7	1-5147734-7	1-5147735-7
38	1.900 [48.26]	1-5147722-8	1-5147734-8	1-5147735-8
40	2.000 [50.80]	1-5147722-9	1-5147734-9	1-5147735-9
50	2.500 [63.50]	2-5147722-4	2-5147734-4	2-5147735-4
60	3.000 [76.20]	2-5147722-9	2-5147734-9	2-5147735-9

## Receptacle Assemblies, Vertical Mount

### Product Facts

- Dual-cantilever beam contact with box design
- Single-row assemblies have .100 [2.54] centerline contact spacing; double-row assemblies have .100 x .100 [2.54 x 2.54] centerline contact spacing
- 3 through 40 positions in single-row assemblies; 2 through 80 positions in double-row assemblies
- Mod II Standard .340 [8.64] and Mod IV low .265 [6.73] profiles
- Mod II and Mod IV profiles available in dual entry
- Duplex gold and matte tin plated contacts have full nickel underplate
- Thermoplastic housings, 94V-0 rated
- Standoffs for easy flux cleaning
- All throughhole assemblies are end stackable
- Recognized under the Component Program of Underwriters Laboratories Inc., File No. E28476 
- Certified by Canadian Standards Association, File No. LR 7189 

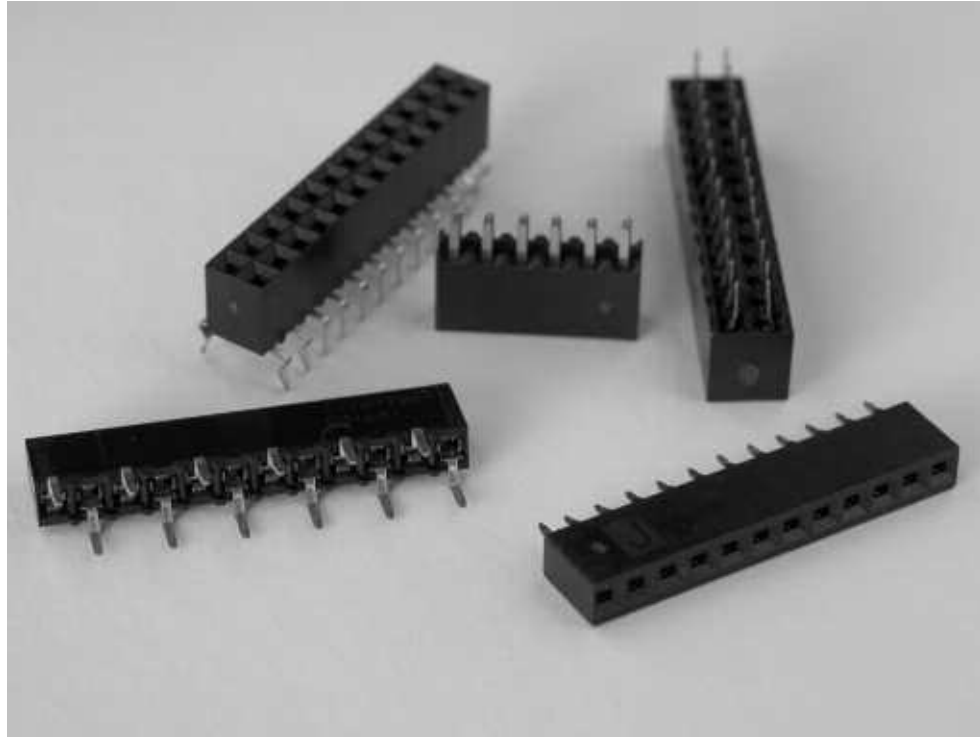

Vertical receptacle assemblies are designed to reliably and economically meet the packaging and interconnection requirements of today's electronics industry.

This broad product line offers a wide variety of assembly styles and features. They are available in dual entry style, in both single and double row configurations. The .100 [2.54] centerline assemblies are available in 3-40 (single

row) positions and 2-80 (double row) positions. Standard and low profile housings which are end stackable also enhance the product line giving the advantage of added flexibility.

The housings are made of flame retardant material that is 94 V-0 rated. Contacts are phosphor bronze, fully underplated with nickel to help prevent corrosion and are available in three plating options.

The receptacle contact is an established proven design, with a fully enclosed one-piece "box" to protect the contact beams.

These assemblies are offered in .265 [6.73] (Mod IV) and .340 [8.64] (Mod II) high profiles. Standard solder tails accommodate board thickness of .062 [1.57].

Product styles include single and dual tine variations. Outrigger tine styles are also available for bottom entry parallel board stacking applications.

### Performance Characteristics

#### Mechanical Characteristics

- Mating Force** — 9.0 oz. [2.5N] per contact (max.)
- Unmating Force** — 1.5 oz. [0.42N] per contact (min.)
- Durability (Tested to)** — 200 cycles

#### Environmental Characteristics

- Operating Temperature** — -65°C to +125°C

#### Electrical Characteristics

- Current Rating** — 3.0 amperes (max.) for single contact; 2.0 amperes (max.) per contact when connector is fully energized
- Contact Resistance** — 12 milliohms (max.)
- Insulation Resistance** — 5000 megohms (min.) between adjacent contacts
- Dielectric Withstanding Voltage (at sea level)** — 750 V rms

## Mod II Receptacle Assemblies, Single-Row, .100 [2.54] Centerline

**Closed Top Entry, End Stackable, with Single Tine Contacts**



**Material and Finish**

**Housing** — Glass-filled thermoplastic, black, 94V-0 rated

**Contacts** — Phosphor bronze, plated as follows:

**Plating A** — Duplex .000030 [0.00076] gold on contact area, .000150-.000300 [0.00381-0.00762] matte tin on solder area all over .000050 [0.00127] nickel

**Plating B** — Duplex .000010 [0.000254] gold on contact area, .000150-.000300 [0.00381-0.00762] matte tin on solder area all over .000050 [0.00127] nickel

**Plating C** — .000150-.000300 [0.00381-0.00762] matte tin on solder leads, all over .000050 [0.00127] nickel

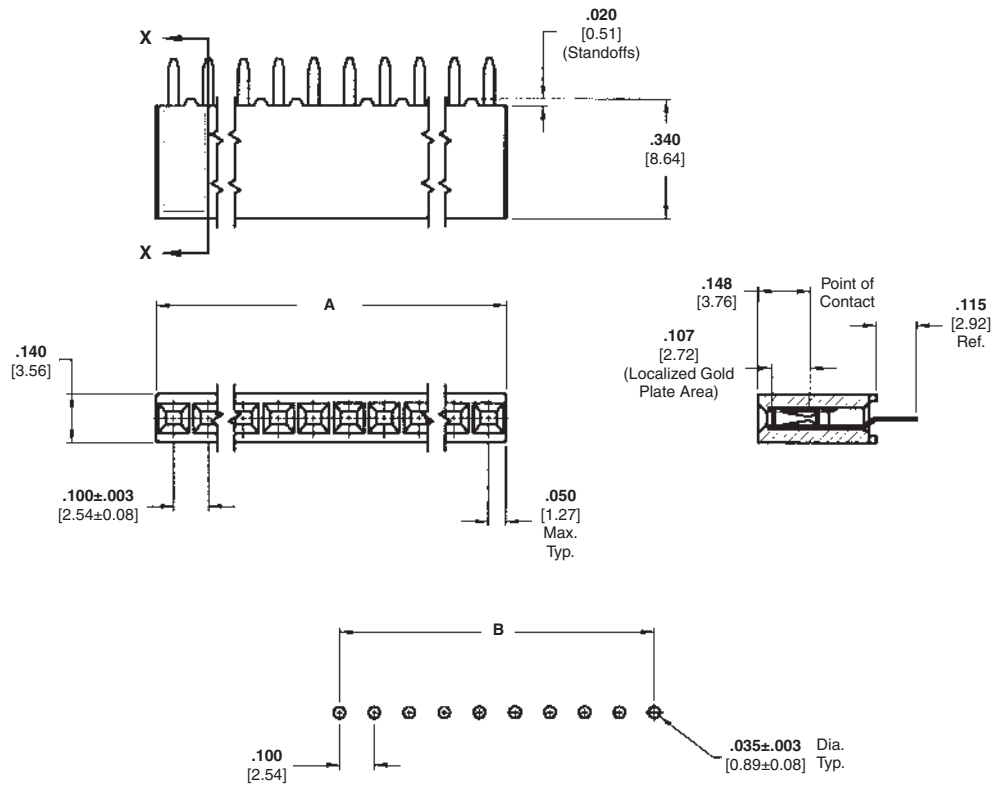

Recommended PC Board Hole Layout

**Related Product Data**

**Mateable Headers** — Refer to the Mating Post Selection Guide — page 90

**Performance Characteristics** — page 174

**Technical Documents** — page 276

**Product Specification** 108-25022

**Application Specification** 114-25018

**Additional receptacle assembly sizes are available; minimum order quantities may apply. Consult TE.**

**Keying Plug**

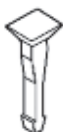

**Part No. 86286-1**

(Plugs into receptacle contact)

**Material** — Natural color nylon

No. of Pos.	Dimensions		Contact Plating/Part Nos.		
	A	B	Plating A	Plating B	Plating C
3	.300 [7.62]	.200 [5.08]	5-534237-1	5-146386-1	5-146763-5
4	.400 [10.16]	.300 [7.62]	5-534237-2	6-146386-9	5-146763-6
5	.500 [12.70]	.400 [10.16]	5-534237-3	5-146386-2	5-146763-7
6	.600 [15.24]	.500 [12.70]	5-534237-4	5-146386-3	5-146763-8
7	.700 [17.78]	.600 [15.24]	5-534237-5	5-146386-4	5-146763-1
8	.800 [20.32]	.700 [17.78]	5-534237-6	5-146386-5	5-146763-2
9	.900 [22.86]	.800 [20.32]	5-534237-7	5-146386-6	5-146763-9
10	1.000 [25.40]	.900 [22.86]	5-534237-8	5-146386-7	5-146763-3
11	1.100 [27.94]	1.000 [25.40]	5-534237-9	5-146386-8	6-146763-0
12	1.200 [30.48]	1.100 [27.94]	6-534237-0	5-146386-9	6-146763-1
13	1.300 [33.02]	1.200 [30.48]	6-534237-1	6-146386-0	6-146763-2
14	1.400 [35.56]	1.300 [33.02]	6-534237-2	6-146386-1	6-146763-3
15	1.500 [38.10]	1.400 [35.56]	6-534237-3	7-146386-0	6-146763-4
16	1.600 [40.64]	1.500 [38.10]	6-534237-4	7-146386-1	6-146763-5
17	1.700 [43.18]	1.600 [40.64]	6-534237-5	7-146386-2	6-146763-6
18	1.800 [45.72]	1.700 [43.18]	6-534237-6	7-146386-3	6-146763-7
19	1.900 [48.26]	1.800 [45.72]	6-534237-7	7-146386-4	6-146763-8
20	2.000 [50.80]	1.900 [48.26]	6-534237-8	6-146386-2	6-146763-9
30	3.000 [76.20]	2.900 [73.66]	7-534237-8	6-146386-8	7-146763-8
40	4.000 [101.60]	3.900 [99.06]	8-534237-8	8-146386-8	8-146763-8

- Notes:** 1. TE recommends mating gold or duplex plated headers with duplex plated receptacle assemblies.  
 2. To obtain the minimum mating post length, add .020 [0.51] (not including the post lead in chamfer) to the maximum point-of-contact dimension.

**Note:** All part numbers are RoHS compliant.

## Mod II Receptacle Assemblies, Double-Row, .100 x .100 [2.54 x 2.54] Centerline

**Closed Top Entry, Side and End Stackable .100 x .100 [2.54 x 2.54] Centerline, .100 [2.54] Tine Spacing**



### Material and Finish

**Housing** — Glass-filled thermoplastic, black, 94V-0 rated

**Contacts** — Phosphor bronze, plated as follows:

**Plating A** — Duplex .000030 [0.00076] gold on contact area, .000150-.000300 [0.00381-0.00762] matte tin on solder area all over .000050 [0.00127] nickel

**Plating B** — Duplex .000010 [0.000254] gold on contact area, .000150-.000300 [0.00381-0.00762] matte tin on solder area all over .000050 [0.00127] nickel

**Plating C** — .000150-.000300 [0.00381-0.00762] matte tin on solder leads, all over .000050 [0.00127] nickel

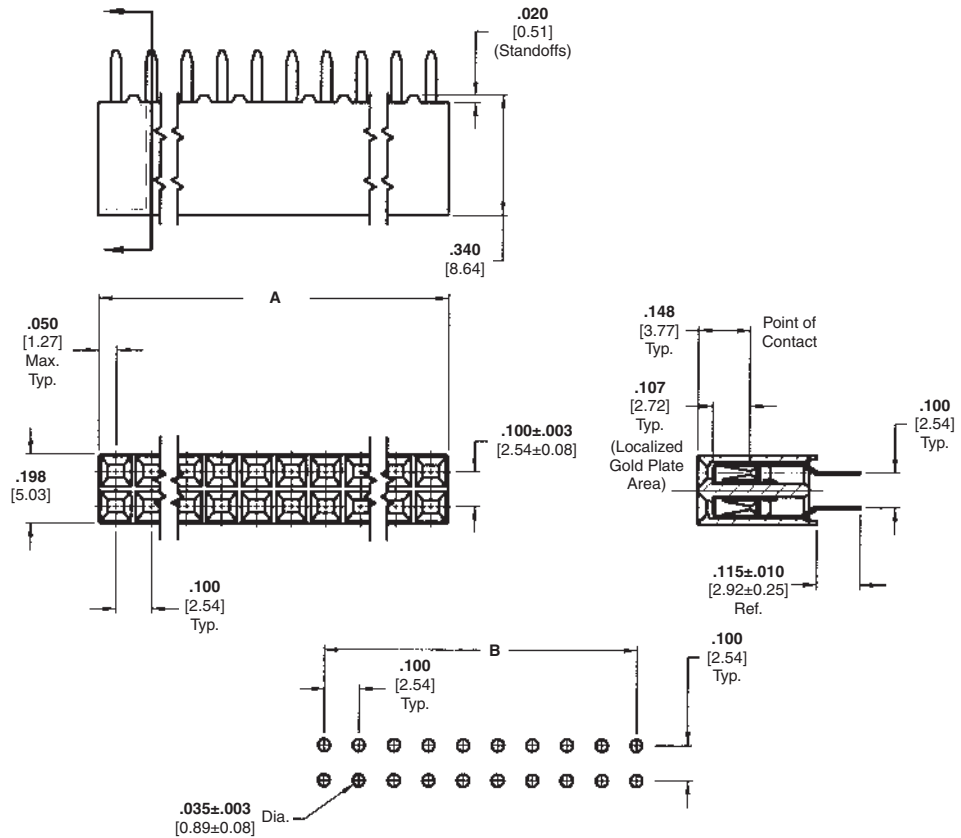

**Recommended PC Board Hole Layout (for .062 [1.57] thick PC board)**

### Related Product Data

**Mateable Headers** — Refer to the Mating Post Selection Guide — page 90

**Performance Characteristics** — page 174

**Technical Documents** — page 276

**Product Specification** 108-25022

**Application Specification** 114-25018

**Additional receptacle assembly sizes are available; minimum order quantities may apply. Consult TE.**

### Keying Plug

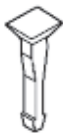

**Part No. 86286-1**

(Plugs into receptacle contact)

**Material** — Natural color nylon

No. of Pos.	Dimensions		Contact Plating/Part Nos.		
	A	B	Plating A	Plating B	Plating C
2	.100 [2.54]	—	5-534206-1	5-147424-1	5-146762-8
4	.200 [5.08]	.100 [2.54]	5-534206-2	5-147424-2	5-146762-9
6	.300 [7.62]	.200 [5.08]	5-534206-3	5-147424-3	6-146762-0
8	.400 [10.16]	.300 [7.62]	5-534206-4	5-147424-4	5-146762-1
10	.500 [12.70]	.400 [10.16]	5-534206-5	5-147424-5	5-146762-2
12	.600 [15.24]	.500 [12.70]	5-534206-6	5-147424-6	6-146762-1
14	.700 [17.78]	.600 [15.24]	5-534206-7	5-147424-7	6-146762-2
16	.800 [20.32]	.700 [17.78]	5-534206-8	5-147424-8	6-146762-3
18	.900 [22.86]	.800 [20.32]	5-534206-9	5-147424-9	5-146762-3
20	1.000 [25.40]	.900 [22.86]	6-534206-0	6-147424-0	5-146762-7
22	1.100 [27.94]	1.000 [25.40]	6-534206-1	6-147424-1	6-146762-4
24	1.200 [30.48]	1.100 [27.94]	6-534206-2	6-147424-2	6-146762-5
26	1.300 [33.02]	1.200 [30.48]	6-534206-3	6-147424-3	6-146762-6
28	1.400 [35.56]	1.300 [33.02]	6-534206-4	6-147424-4	6-146762-7
30	1.500 [38.10]	1.400 [35.56]	6-534206-5	6-147424-5	5-146762-4
32	1.600 [40.64]	1.500 [38.10]	6-534206-6	6-147424-6	6-146762-8
34	1.700 [43.18]	1.600 [40.64]	6-534206-7	6-147424-7	6-146762-9
36	1.800 [45.72]	1.700 [43.18]	6-534206-8	6-147424-8	7-146762-0
38	1.900 [48.26]	1.800 [45.72]	6-534206-9	6-147424-9	7-146762-1
40	2.000 [50.80]	1.900 [48.26]	7-534206-0	7-147424-0	5-146762-5

**Notes:** 1. TE recommends mating gold or duplex plated headers with duplex plated receptacle assemblies.

2. To obtain the minimum mating post length, add .020 [0.51] (not including the post lead in chamfer) to the maximum point-of-contact dimension.

**Note:** All part numbers are RoHS compliant.



## Mod IV Receptacle Assemblies, Single-Row, .100 [2.54] Centerline

**Dual Entry, End Stackable, Low Profile with Dual Tine Contacts**



### Material and Finish

**Housing** — Glass-filled thermoplastic, black, 94V-0 rated

**Contacts** — Phosphor bronze, plated as follows:

**Plating A** — Duplex .000030 [0.00076] gold on contact area, .000150-.000300 [0.00381-0.00762] matte tin on solder area all over .000050 [0.00127] nickel

**Plating B** — Duplex .000010 [0.000254] gold on contact area, .000150-.000300 [0.00381-0.00762] matte tin on solder area all over .000050 [0.00127] nickel

**Plating C** — .000150-.000300 [0.00381-0.00762] matte tin on solder leads, all over .000050 [0.00127] nickel

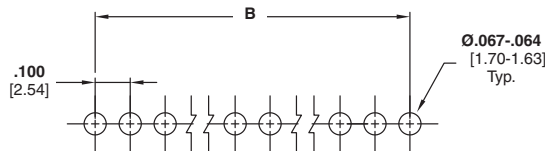
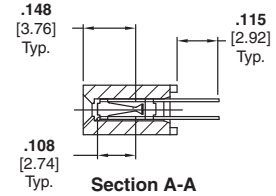
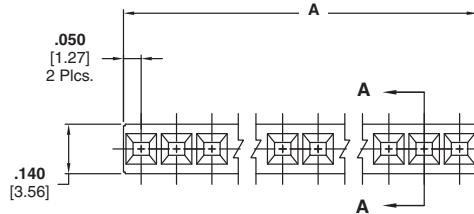
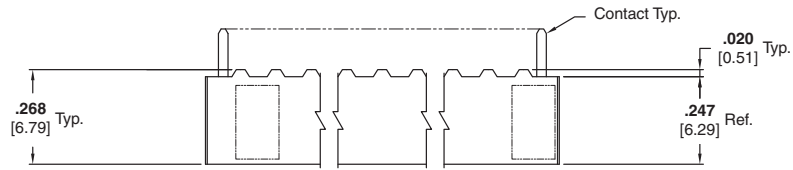

Recommended PC Board Hole Layout

### Related Product Data

**Mateable Headers** — Refer to the Mating Post Selection Guide — page 90

**Performance Characteristics** — page 174

**Technical Documents** — page 276

**Product Specification** 108-25022

**Application Specification** 114-25018

**Additional receptacle assembly sizes are available; minimum order quantities may apply. Consult TE.**

### Keying Plug

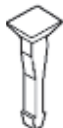

**Part No. 86286-1**  
(Plugs into receptacle contact)

**Material** — Natural color nylon

**Note:** All part numbers are RoHS compliant.

No. of Pos.	Dimensions		Contact Plating/Part Nos.		
	A	B	Plating A	Plating B	Plating C
3	.300 [7.62]	.200 [5.08]	8-87879-7	5-147326-1	5-102742-4
4	.400 [10.16]	.300 [7.62]	8-87879-6	5-147326-2	5-102742-8
5	.500 [12.70]	.400 [10.16]	8-87879-8	5-147326-3	5-102742-9
6	.600 [15.24]	.500 [12.70]	5-87879-3	5-147326-4	6-102742-0
7	.700 [17.78]	.600 [15.24]	5-87879-4	5-147326-5	5-102742-7
8	.800 [20.32]	.700 [17.78]	5-87879-1	5-147326-6	5-102742-3
9	.900 [22.86]	.800 [20.32]	5-87879-5	5-147326-7	5-102742-6
10	1.000 [25.40]	.900 [22.86]	5-87879-2	5-147326-8	6-102742-1
11	1.100 [27.94]	1.000 [25.40]	5-87879-6	5-147326-9	5-102742-1
12	1.200 [30.48]	1.100 [27.94]	5-87879-7	6-147326-0	5-102742-2
13	1.300 [33.02]	1.200 [30.48]	5-87879-8	6-147326-1	6-102742-2
14	1.400 [35.56]	1.300 [33.02]	5-87879-9	6-147326-2	6-102742-3
15	1.500 [38.10]	1.400 [35.56]	6-87879-0	6-147326-3	6-102742-4
16	1.600 [40.64]	1.500 [38.10]	6-87879-1	6-147326-4	5-102742-5
17	1.700 [43.18]	1.600 [40.64]	6-87879-2	6-147326-5	6-102742-5
18	1.800 [45.72]	1.700 [43.18]	6-87879-3	6-147326-6	6-102742-6
19	1.900 [48.26]	1.800 [45.72]	6-87879-4	6-147326-7	6-102742-7
20	2.000 [50.80]	1.900 [48.26]	6-87879-5	6-147326-8	6-102742-8
30	3.000 [76.20]	2.900 [73.66]	7-87879-5	7-147326-8	7-102742-8
40	4.000 [101.60]	3.900 [99.06]	8-87879-5	8-147326-8	8-102742-8

- Notes:** 1. TE recommends mating gold or duplex plated headers with duplex plated receptacle assemblies.  
2. To obtain the minimum mating post length, add .020 [0.51] (not including the post lead in chamfer) to the maximum point-of-contact dimension and .062 for recommended board thickness.

## Mod IV Receptacle Assemblies, Single-Row, .100 [2.54] Centerline

**Closed Top Entry, End Stackable, Low Profile with Single Tine Contacts**

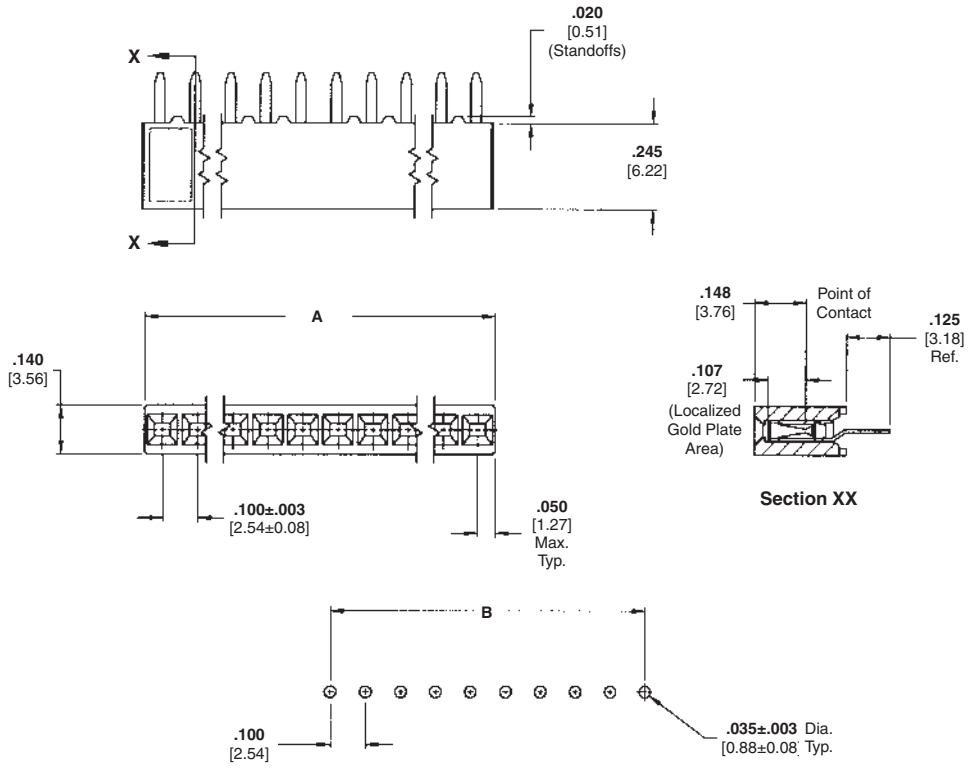

**Recommended PC Board Hole Layout (for .062 [1.57] thick PC board)**

### Material and Finish

**Housing** — Glass-filled thermoplastic, black, 94V-0 rated

**Contacts** — Phosphor bronze, plated as follows:

**Plating A** — Duplex .000030 [0.00076] gold on contact area, .000150-.000300 [0.00381-0.00762] matte tin on solder area all over .000050 [0.00127] nickel

**Plating B** — Duplex .000010 [0.000254] gold on contact area, .000150-.000300 [0.00381-0.00762] matte tin on solder area all over .000050 [0.00127] nickel

**Plating C** — .000150-.000300 [0.00381-0.00762] matte tin on solder leads, all over .000050 [0.00127] nickel

### Related Product Data

**Mateable Headers** — Refer to the Mating Post Selection Guide — page 90

**Performance Characteristics** — page 174

**Technical Documents** — page 276

**Product Specification** 108-25022

**Application Specification** 114-25018

**Additional receptacle assembly sizes are available; minimum order quantities may apply. Consult TE.**

No. of Pos.	Dimensions		Contact Plating/Part Nos.		
	A	B	Plating A	Plating B	Plating C
3	.300 [7.62]	.200 [5.08]	5-535541-1	5-146138-1	5-535584-3
4	.400 [10.16]	.300 [7.62]	5-535541-2	5-146138-2	5-535584-4
5	.500 [12.70]	.400 [10.16]	5-535541-3	5-146138-3	5-535584-5
6	.600 [15.24]	.500 [12.70]	5-535541-4	5-146138-4	5-535584-1
7	.700 [17.78]	.600 [15.24]	5-535541-5	5-146138-5	5-535584-6
8	.800 [20.32]	.700 [17.78]	5-535541-6	5-146138-6	5-535584-7
9	.900 [22.86]	.800 [20.32]	5-535541-7	5-146138-7	5-535584-8
10	1.000 [25.40]	.900 [22.86]	5-535541-8	5-146138-8	5-535584-9
11	1.100 [27.94]	1.000 [25.40]	5-535541-9	5-146138-9	6-535584-0
12	1.200 [30.48]	1.100 [27.94]	6-535541-0	6-146138-0	6-535584-1
13	1.300 [33.02]	1.200 [30.48]	6-535541-1	6-146138-1	6-535584-2
14	1.400 [35.56]	1.300 [33.02]	6-535541-2	6-146138-2	6-535584-3
15	1.500 [38.10]	1.400 [35.56]	6-535541-3	6-146138-3	6-535584-4
16	1.600 [40.64]	1.500 [38.10]	6-535541-4	6-146138-4	6-535584-5
17	1.700 [43.18]	1.600 [40.64]	6-535541-5	6-146138-5	6-535584-6
18	1.800 [45.72]	1.700 [43.18]	6-535541-6	6-146138-6	5-535584-2
19	1.900 [48.26]	1.800 [45.72]	6-535541-7	6-146138-7	6-535584-7
20	2.000 [50.80]	1.900 [48.26]	6-535541-8	6-146138-8	6-535584-8
30	3.000 [76.20]	2.900 [73.66]	7-535541-9	7-146138-9	6-535584-9
40	4.000 [101.60]	3.900 [99.06]	8-535541-9	8-146138-9	7-535584-0

**Notes:** 1. TE recommends mating gold or duplex plated headers with select gold plated receptacle assemblies.  
2. To obtain the minimum mating post length, add .020 [0.51] (not including the post lead in chamfer) to the maximum point-of-contact dimension.

**Note:** All part numbers are RoHS compliant.

Vertical Mount Receptacle Assemblies

5

## Mod IV Receptacle Assemblies, Double-Row, .100 x .100 [2.54 x 2.54] Centerline

**Closed Top Entry, End and Side Stackable, Low Profile, .100 x .100 [2.54 x 2.54] Centerline, .100 [2.54] Tine Spacing**

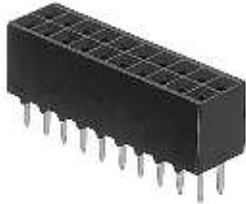

### Material and Finish

**Housing** — Glass-filled thermoplastic, black, 94V-0 rated

**Contacts** — Phosphor bronze, plated as follows:

**Plating A** — Duplex .000030 [0.00076] gold on contact area, .000150-.000300 [0.00381-0.00762] matte tin on solder area all over .000050 [0.00127] nickel

**Plating B** — Duplex .000010 [0.000254] gold on contact area, .000150-.000300 [0.00381-0.00762] matte tin on solder area all over .000050 [0.00127] nickel

**Plating C** — .000150-.000300 [0.00381-0.00762] matte tin on solder leads, all over .000050 [0.00127] nickel

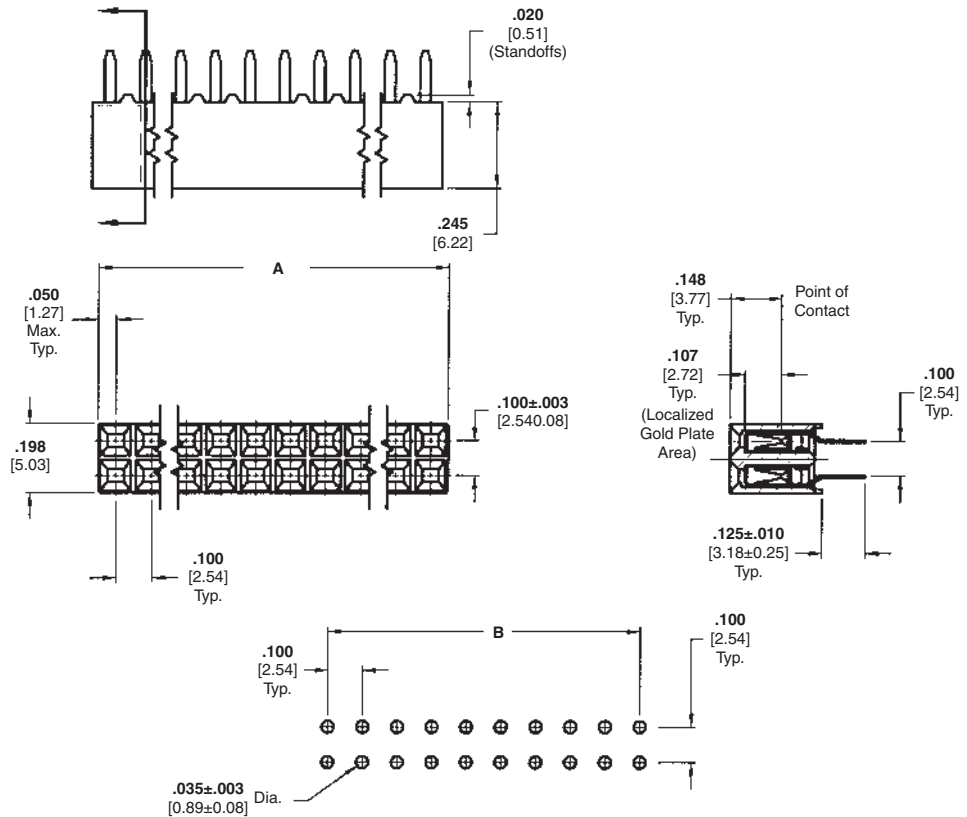

Recommended PC Board Hole Layout

### Related Product Data

**Mateable Headers** — Refer to the Mating Post Selection Guide — page 90

**Performance Characteristics** — page 174

**Technical Documents** — page 276

**Product Specification**  
108-25022

**Application Specification**  
114-25018

No. of Pos.	Dimensions		Contact Plating/Part Nos.		
	A	B	Plating A	Plating B	Plating C
2	.100 [2.54]	—	5-534998-1	5-535598-2	5-535585-3
4	.200 [5.08]	.100 [2.54]	5-534998-2	5-535598-3	5-535585-4
6	.300 [7.62]	.200 [5.08]	5-534998-3	5-535598-4	5-535585-5
8	.400 [10.16]	.300 [7.62]	5-534998-4	5-535598-5	5-535585-6
10	.500 [12.70]	.400 [10.16]	5-534998-5	5-535598-6	5-535585-1
12	.600 [15.24]	.500 [12.70]	5-534998-6	5-535598-7	5-535585-2
14	.700 [17.78]	.600 [15.24]	5-534998-7	5-535598-1	5-535585-7
16	.800 [20.32]	.700 [17.78]	5-534998-8	5-535598-8	5-535585-8
18	.900 [22.86]	.800 [20.32]	5-534998-9	5-535598-9	5-535585-9
20	1.000 [25.40]	.900 [22.86]	6-534998-0	6-535598-0	6-535585-0
22	1.100 [27.94]	1.000 [25.40]	6-534998-1	6-535598-1	6-535585-1
24	1.200 [30.48]	1.100 [27.94]	6-534998-2	6-535598-2	6-535585-2
26	1.300 [33.02]	1.200 [30.48]	6-534998-3	6-535598-3	6-535585-3
28	1.400 [35.56]	1.300 [33.02]	6-534998-4	6-535598-4	6-535585-4
30	1.500 [38.10]	1.400 [35.56]	6-534998-5	6-535598-5	6-535585-5
32	1.600 [40.64]	1.500 [38.10]	6-534998-6	6-535598-6	6-535585-6
34	1.700 [43.18]	1.600 [40.64]	6-534998-7	6-535598-7	6-535585-7
36	1.800 [45.72]	1.700 [43.18]	6-534998-8	6-535598-8	6-535585-8
38	1.900 [48.26]	1.800 [45.72]	6-534998-9	6-535598-9	6-535585-9
40	2.000 [50.80]	1.900 [48.26]	7-534998-0	7-535598-0	7-535585-0

- Notes:**
- TE recommends mating gold or duplex plated headers with duplex plated receptacle assemblies.
  - To obtain the minimum mating post length, add .020 [0.51] (not including the post lead in chamfer) to the maximum point-of-contact dimension.

**Note:** All part numbers are RoHS compliant.

**Mod IV Receptacle Assemblies, Double-Row,  
 .100 x .100 [2.54 x 2.54] Centerline** (Continued)

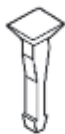
**Keying Plug**

**Part No. 86286-1**

(Plugs into receptacle contact)

**Material** — Natural color nylon

No. of Pos.	Dimensions		Contact Plating/Part Nos.		
	A	B	Plating A	Plating B	Plating C
42	2.100 [53.34]	2.000 [50.80]	7-534998-1	7-535598-4	7-535585-4
44	2.200 [55.88]	2.100 [53.34]	7-534998-2	7-535598-5	7-535585-5
46	2.300 [58.42]	2.200 [55.88]	7-534998-3	7-535598-6	7-535585-6
48	2.400 [60.96]	2.300 [58.42]	7-534998-4	7-535598-7	7-535585-7
50	2.500 [63.50]	2.400 [60.96]	7-534998-5	7-535598-1	7-535585-1
52	2.600 [66.04]	2.500 [63.50]	7-534998-6	7-535598-8	7-535585-8
54	2.700 [68.58]	2.600 [66.04]	7-534998-7	7-535598-9	7-535585-9
56	2.800 [71.12]	2.700 [68.58]	7-534998-8	8-535598-0	8-535585-0
58	2.900 [73.66]	2.800 [71.12]	7-534998-9	8-535598-1	8-535585-1
60	3.000 [76.20]	2.900 [73.66]	8-534998-0	7-535598-2	7-535585-2
62	3.100 [78.74]	3.000 [76.20]	8-534998-1	8-535598-2	8-535585-2
64	3.200 [81.28]	3.100 [78.74]	8-534998-2	8-535598-3	8-535585-3
66	3.300 [83.82]	3.200 [81.28]	8-534998-3	8-535598-4	8-535585-4
68	3.400 [86.36]	3.300 [83.82]	8-534998-4	8-535598-5	8-535585-5
70	3.500 [88.90]	3.400 [86.36]	8-534998-5	8-535598-6	8-535585-6
72	3.600 [91.44]	3.500 [88.90]	8-534998-6	8-535598-7	8-535585-7
74	3.700 [93.98]	3.600 [91.44]	8-534998-7	8-535598-8	8-535585-8
76	3.800 [96.52]	3.700 [93.98]	8-534998-8	8-535598-9	8-535585-9
78	3.900 [99.06]	3.800 [96.52]	8-534998-9	9-535598-0	9-535585-0
80	4.000 [101.60]	3.900 [99.06]	9-534998-0	7-535598-3	7-535585-3

- Notes:** 1. TE recommends mating gold or duplex plated headers with duplex plated receptacle assemblies.  
 2. To obtain the minimum mating post length, add .020 [0.51] (not including the post lead in chamfer) to the maximum point-of-contact dimension.

**Note:** All part numbers are RoHS compliant.

## Mod IV Receptacle Assemblies, Single-Row, Outrigger Design .100 x .100 [2.54 x 2.54] Centerline, End To End Stackable

**Dual Entry, End Stackable,  
Low Profile, .100 x .100  
[2.54 x 2.54] Centerline,  
.200 [5.08] Tine Spacing**

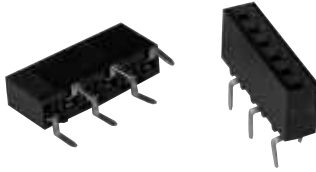

### Material and Finish

**Housing** — Glass-filled thermoplastic, black, 94V-0 rated

**Plating A** — Duplex .000030 [0.00076] gold on contact area, .000150-.000300 [0.00381-0.00762] matte tin on solder area all over .000050 [0.00127] nickel

**Plating B** — Duplex .000010 [0.000254] gold on contact area, .000150-.000300 [0.00381-0.00762] matte tin on solder area all over .000050 [0.00127] nickel

**Plating C** — .000150-.000300 [0.00381-0.00762] matte tin on solder leads, all over .000050 [0.00127] nickel

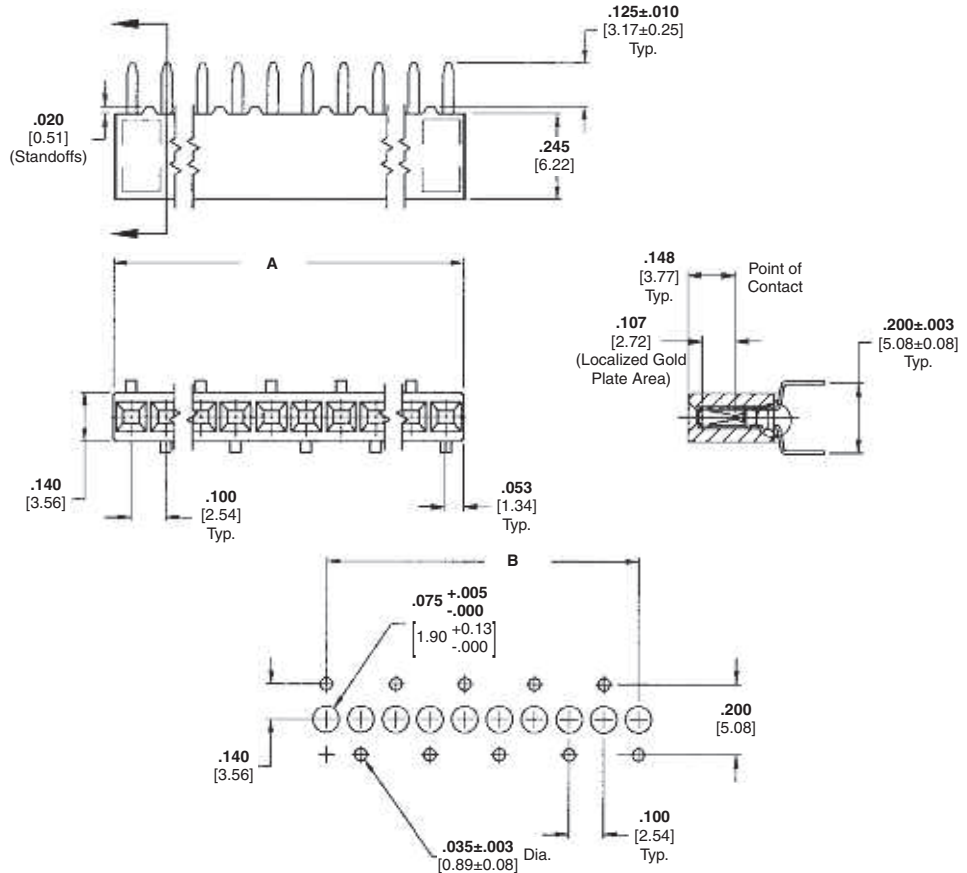

Recommended PC Board Hole Layout

No. of Pos.	Dimensions		Contact Plating/Part Nos.		
	A	B	Plating A	Plating B	Plating C
3	.300 [7.62]	.200 [5.08]	5-147720-2	5-147726-2	5-147727-2
4	.400 [10.16]	.300 [7.62]	5-147720-3	5-147726-3	5-147727-3
5	.500 [12.70]	.400 [10.16]	5-147720-4	5-147726-4	5-147727-4
6	.600 [15.24]	.500 [12.70]	5-147720-5	5-147726-5	5-147727-5
7	.700 [17.78]	.600 [15.24]	5-147720-6	5-147726-6	5-147727-6
8	.800 [20.32]	.700 [17.78]	5-147720-7	5-147726-7	5-147727-7
9	.900 [22.86]	.800 [20.32]	5-147720-8	5-147726-8	5-147727-8
10	1.000 [25.40]	.900 [22.86]	5-147720-9	5-147726-9	5-147727-9
11	1.100 [27.94]	1.000 [25.40]	6-147720-0	6-147726-0	6-147727-0
12	1.200 [30.48]	1.100 [27.94]	6-147720-1	6-147726-1	6-147727-1
13	1.300 [33.02]	1.200 [30.48]	6-147720-2	6-147726-2	6-147727-2
14	1.400 [35.56]	1.300 [33.02]	6-147720-3	6-147726-3	6-147727-3
15	1.500 [38.10]	1.400 [35.56]	6-147720-4	6-147726-4	6-147727-4
16	1.600 [40.64]	1.500 [38.10]	6-147720-5	6-147726-5	6-147727-5
17	1.700 [43.18]	1.600 [40.64]	6-147720-6	6-147726-6	6-147727-6
18	1.800 [45.72]	1.700 [43.18]	6-147720-7	6-147726-7	6-147727-7
19	1.900 [48.26]	1.800 [45.72]	6-147720-8	6-147726-8	6-147727-8
20	2.000 [50.80]	1.900 [48.26]	7-147720-8	7-147726-8	7-147727-8
30	3.000 [76.20]	2.900 [73.66]	8-147720-8	8-147726-8	8-147727-8
40	4.000 [101.60]	3.900 [99.06]	8-147720-9	8-147726-9	8-147727-9

**Notes:** 1. TE recommends mating gold or duplex plated headers with duplex plated receptacle assemblies.

2. To obtain the minimum mating post length, add .020 [0.51] (not including the post lead in chamfer) to the maximum point-of-contact dimension and add .062 [1.57] for recommended board thickness if used in bottom entry application.

**Note:** All part numbers are RoHS compliant.

## Mod IV Receptacle Assemblies, Double-Row, Outtrigger Design, .100 x .100 [2.54 x 2.54] Centerline, End to End Stackable

**Dual Entry, End Stackable, Low Profile, .100 x .100 [2.54 x 2.54] Centerline, .300 [7.62] Tine Spacing**

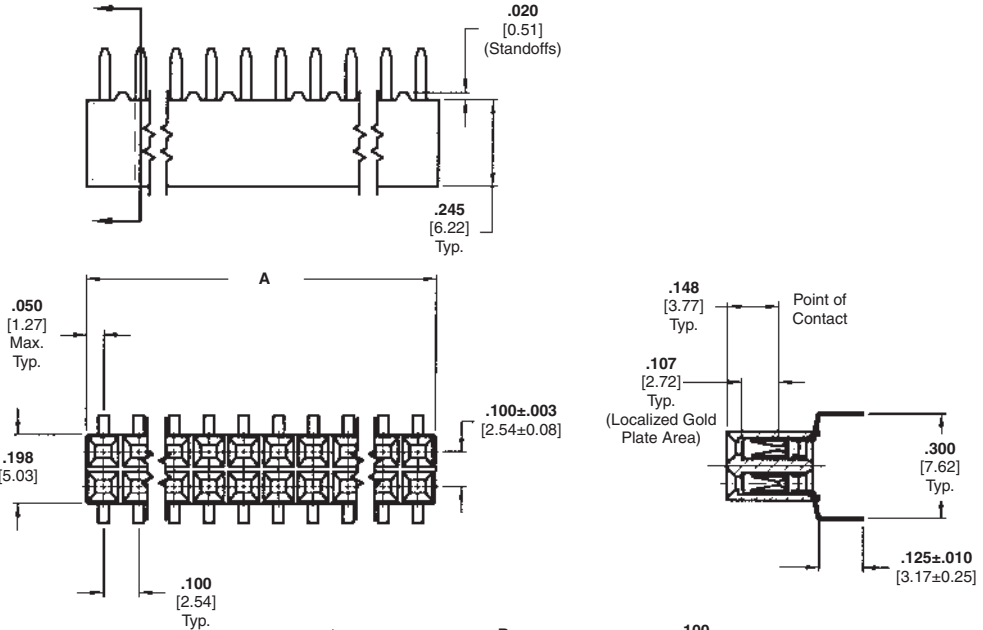
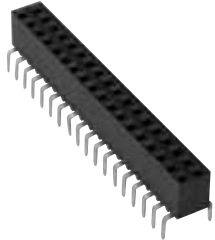

### Material and Finish

**Housing** — Glass-filled thermoplastic, black, 94V-0 rated

**Contacts** — Phosphor bronze, plated as follows:

**Plating A** — Duplex .000030 [0.00076] gold on contact area, .000150-.000300 [0.00381-0.00762] matte tin on solder area all over .000050 [0.00127] nickel

**Plating B** — Duplex .000010 [0.000254] gold on contact area, .000150-.000300 [0.00381-0.00762] matte tin on solder area all over .000050 [0.00127] nickel

**Plating C** — .000150-.000300 [0.00381-0.00762] matte tin on solder leads, all over .000050 [0.00127] nickel

### Related Product Data

**Mateable Headers** — Refer to the Mating Post Selection Guide — page 90

**Performance Characteristics** — page 174

**Technical Documents** — page 276

**Product Specification** 108-25022

**Application Specification** 114-25018

**Additional receptacle assembly sizes are available; minimum order quantities may apply. Consult TE.**

### Keying Plug

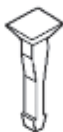

**Part No. 86286-1**  
(Plugs into receptacle contact)

**Material** — Natural color nylon

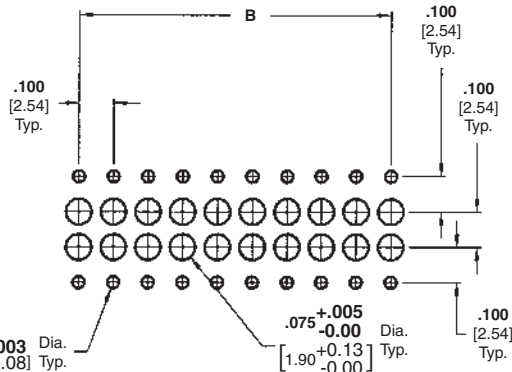

Recommended PC Board Hole Layout

No. of Pos.	Dimensions		Contact Plating/Part Nos.		
	A	B	Plating A	Plating B	Plating C
2	.100 [2.54]	—	6-534267-3	5-147099-1	8-147100-9
4	.200 [5.08]	.100 [2.54]	6-534267-7	5-147099-2	9-147100-0
6	.300 [7.62]	.200 [5.08]	6-534267-4	5-147099-3	5-147100-1
8	.400 [10.16]	.300 [7.62]	5-534267-5	5-147099-4	5-147100-2
14	.700 [17.78]	.600 [15.24]	5-534267-1	5-147099-7	5-147100-5
18	.900 [22.86]	.800 [20.32]	6-534267-0	5-147099-9	5-147100-7
20	1.000 [25.40]	.900 [22.86]	5-534267-2	6-147099-0	5-147100-8
24	1.200 [30.48]	1.100 [27.94]	5-534267-9	6-147099-2	6-147100-0
30	1.500 [38.10]	1.400 [35.56]	6-534267-2	6-147099-5	6-147100-3
36	1.800 [45.72]	1.700 [43.18]	6-534267-5	6-147099-8	6-147100-6
40	2.000 [50.80]	1.900 [48.26]	5-534267-7	7-147099-0	6-147100-8
48	2.400 [60.96]	2.300 [58.42]	6-534267-1	7-147099-4	7-147100-2
50	2.500 [63.50]	2.400 [60.96]	6-534267-8	7-147099-5	7-147100-3
60	3.000 [76.20]	2.900 [73.66]	5-534267-8	8-147099-0	7-147100-8
76	3.800 [96.52]	3.700 [93.98]	6-534267-6	8-147099-8	8-147100-6
80	4.000 [101.60]	3.900 [99.06]	5-534267-4	9-147099-0	8-147100-8

**Notes:** 1. TE recommends mating gold or duplex plated headers with duplex plated receptacle assemblies.  
2. To obtain the minimum mating post length, add .020 [0.51] (not including the post lead in chamfer) to the maximum point-of-contact dimension and .062 for recommended board thickness if used in bottom entry application.

**Note:** All part numbers are RoHS compliant.

## Mod. IV Receptacle Assemblies, Double-Row, .100 x .100 [2.54 x 2.54] Centerline

**Closed Dual Entry, Side and End Stackable Low Profile, .100 x .100 [2.54 x 2.54] Centerline, .150 [3.81] Tine Spacing**

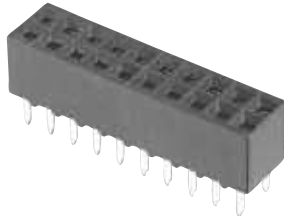

### Material and Finish

**Housing** — Glass-filled thermoplastic, black, 94V-0 rated

**Contacts** — Phosphor bronze, plated as follows:

**Plating A** — Duplex .000030 [0.00076] gold on contact area, .000150-.000300 [0.00381-0.00762] matte tin on solder area all over .000050 [0.00127] nickel

**Plating B** — Duplex .000010 [0.000254] gold on contact area, .000150-.000300 [0.00381-0.00762] matte tin on solder area all over .000050 [0.00127] nickel

**Plating C** — .000150-.000300 [0.00381-0.00762] matte tin on solder leads, all over .000050 [0.00127] nickel

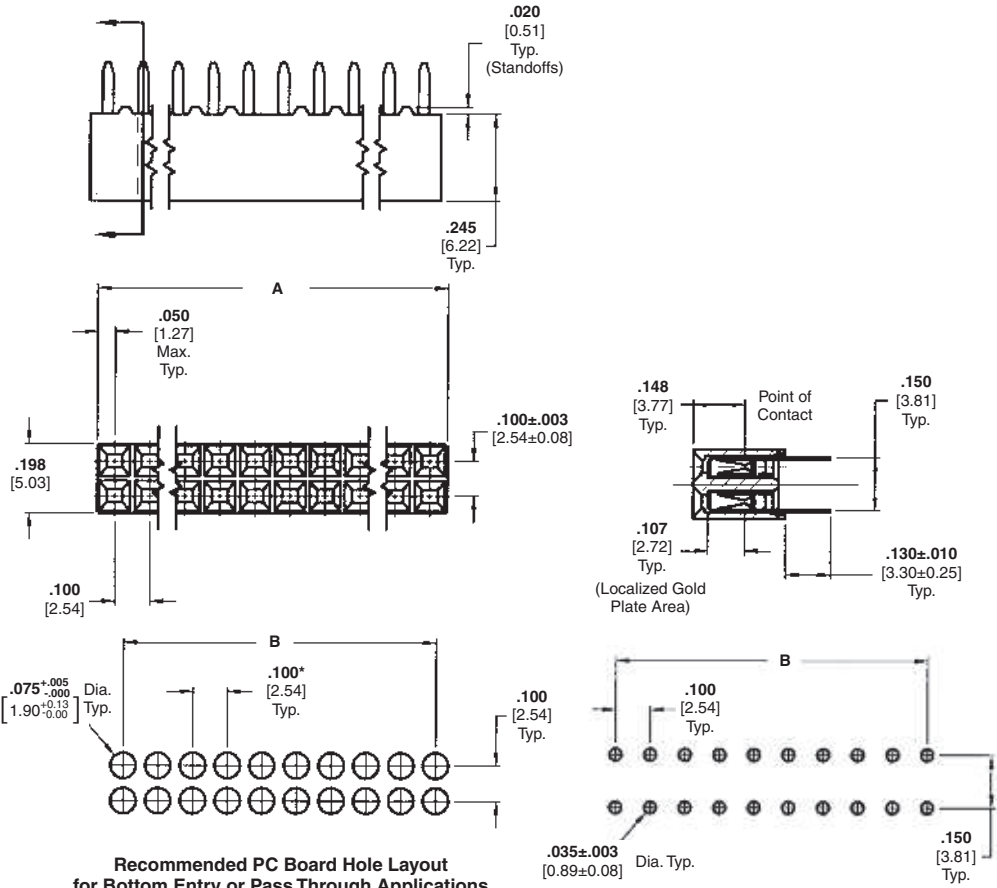

**Recommended PC Board Hole Layout for Bottom Entry or Pass Through Applications**

\*±.003 [±0.08] tolerances not to accumulate within one connector pattern.

**Recommended PC Board Hole Layout for Top Entry**

### Related Product Data

**Mateable Headers** — Refer to the Mating Post Selection Guide — page 90

**Performance Characteristics** — page 174

**Technical Documents** — page 276

**Product Specification**  
108-25022

**Application Specification**  
114-25018

No. of Pos.	Dimensions		Contact Plating/Part Nos.		
	A	B	Plating A	Plating B	Plating C
2	.100 [2.54]	—	5-535542-1	5-147095-1	5-147096-1
4	.200 [5.08]	.100 [2.54]	5-535542-2	5-147095-2	5-147096-2
6	.300 [7.62]	.200 [5.08]	5-535542-3	5-147095-3	5-147096-3
8	.400 [10.16]	.300 [7.62]	5-535542-4	5-147095-4	5-147096-4
10	.500 [12.70]	.400 [10.16]	5-535542-5	5-147095-5	5-147096-5
12	.600 [15.24]	.500 [12.70]	5-535542-6	5-147095-6	5-147096-6
14	.700 [17.78]	.600 [15.24]	5-535542-7	5-147095-7	5-147096-7
16	.800 [20.32]	.700 [17.78]	5-535542-8	5-147095-8	5-147096-8
18	.900 [22.86]	.800 [20.32]	5-535542-9	5-147095-9	5-147096-9
20	1.000 [25.40]	.900 [22.86]	6-535542-0	6-147095-0	6-147096-0
22	1.100 [27.94]	1.000 [25.40]	6-535542-1	6-147095-1	6-147096-1
24	1.200 [30.48]	1.100 [27.94]	6-535542-2	6-147095-2	6-147096-2
26	1.300 [33.02]	1.200 [30.48]	6-535542-3	6-147095-3	6-147096-3
28	1.400 [35.56]	1.300 [33.02]	6-535542-4	6-147095-4	6-147096-4
30	1.500 [38.10]	1.400 [35.56]	6-535542-5	6-147095-5	6-147096-5
32	1.600 [40.64]	1.500 [38.10]	6-535542-6	6-147095-6	6-147096-6
34	1.700 [43.18]	1.600 [40.64]	6-535542-7	6-147095-7	6-147096-7
36	1.800 [45.72]	1.700 [43.18]	6-535542-8	6-147095-8	6-147096-8
38	1.900 [48.26]	1.800 [45.72]	6-535542-9	6-147095-9	6-147096-9
40	2.000 [50.80]	1.900 [48.26]	7-535542-0	7-147095-0	7-147096-0

**Notes:** 1. TE recommends mating gold or duplex plated headers with duplex plated receptacle assemblies.  
2. To obtain the minimum mating post length, add .020 [0.51] (not including the post lead in chamfer) to the maximum point-of-contact dimension, and .062 [1.57] for recommended board thickness if used in bottom entry application.

**Note:** All part numbers are RoHS compliant.

**Mod. IV Receptacle Assemblies, Double-Row,  
.100 x .100 [2.54 x 2.54] Centerline** (Continued)

No. of Pos.	Dimensions		Contact Plating/Part Nos.		
	A	B	Plating A	Plating B	Plating C
42	2.100 [53.34]	2.000 [50.80]	7-535542-1	7-147095-1	7-147096-1
44	2.200 [55.88]	2.100 [53.34]	7-535542-2	7-147095-2	7-147096-2
46	2.300 [58.42]	2.200 [55.88]	7-535542-3	7-147095-3	7-147096-3
48	2.400 [60.96]	2.300 [58.42]	7-535542-4	7-147095-4	7-147096-4
50	2.500 [63.50]	2.400 [60.96]	7-535542-5	7-147095-5	7-147096-5
52	2.600 [66.04]	2.500 [63.50]	7-535542-6	7-147095-6	7-147096-6
54	2.700 [68.58]	2.600 [66.04]	7-535542-7	7-147095-7	7-147096-7
56	2.800 [71.12]	2.700 [68.58]	7-535542-8	7-147095-8	7-147096-8
58	2.900 [73.66]	2.800 [71.12]	7-535542-9	7-147095-9	7-147096-9
60	3.000 [76.20]	2.900 [73.66]	8-535542-0	8-147095-0	8-147096-0
62	3.100 [78.74]	3.000 [76.20]	8-535542-1	8-147095-1	8-147096-1
64	3.200 [81.28]	3.100 [78.74]	8-535542-2	8-147095-2	8-147096-2
66	3.300 [83.82]	3.200 [81.28]	8-535542-3	8-147095-3	8-147096-3
68	3.400 [86.36]	3.300 [83.82]	8-535542-4	8-147095-4	8-147096-4
70	3.500 [88.90]	3.400 [86.36]	8-535542-5	8-147095-5	8-147096-5
72	3.600 [91.44]	3.500 [88.90]	8-535542-6	8-147095-6	8-147096-6
74	3.700 [93.98]	3.600 [91.44]	8-535542-7	8-147095-7	8-147096-7
76	3.800 [96.52]	3.700 [93.98]	8-535542-8	8-147095-8	8-147096-8
78	3.900 [99.06]	3.800 [96.52]	8-535542-9	8-147095-9	8-147096-9
80	4.000 [101.60]	3.900 [99.06]	9-535542-0	9-147095-0	9-147096-0

Vertical Mount  
Receptacle Assemblies



5

**Note:** All part numbers are RoHS compliant.



## Mod IV Surface Mount Vertical Receptacle Assemblies, .100 x .100 [2.54 x 2.54] Centerline

### Product Facts

- Surface Mount Leads
- Contact Material: phosphor bronze
- High temperature, black thermoplastic housings, 94V-0 rated, capable of withstanding IR or vapor-phase reflow
- Gold/tin duplex plating for reliable mating interconnection and solder interface
- Metallic hold downs provide retention in the PC board prior to and during the reflow process ... and strain relief after soldering
- Hold downs provide for proper lead-to-pad registration
- Closed-entry receptacle housings provide lead-in ramp for positive mating
- Receptacle contacts employ dual cantilever beams for reliable connections
- Recognized under the Component Program of Underwriters Laboratories Inc.  File No. E28476
- Certified by Canadian Standards Association,  File No. LR 7189

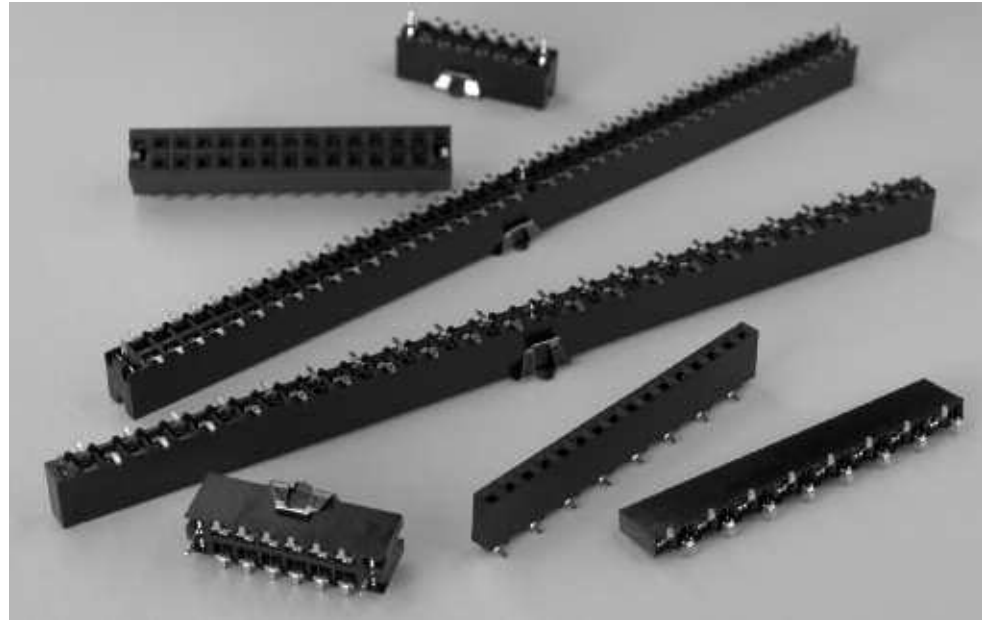

The AMPMODU 0.025 [0.64] square interconnection system is an industry standard that has provided level III and IV thru-hole interconnections to almost every industry and marketplace for years. As technology advances, so has the AMPMODU product line.

Surface mount vertical receptacle assemblies are available to meet your level II packaging needs as process technologies evolve from wave soldering to surface mount reflow (infrared and vapor-phase) processes. AMPMODU surface mount receptacle assemblies are offered in vertical dual entry configurations. These receptacles are available in single-row and double-row configurations with a contact centerline spacing of .100 x .100 [2.54 x 2.54].

AMPMODU surface mount vertical receptacle assemblies continue to provide the proven features and benefits of their thru-hole counterparts in the AMPMODU product family. Closed-entry style housing design provides a lead-in ramp for positive mating of contacts, virtually eliminating the possibility of stubbing. The dual-beam receptacle contact design, coupled with gold plating in the contact area, provides a reliable interface. Tin plating on the solder tails also enhances solderability.

The incorporation of compliant metallic hold downs on receptacle assemblies offers multiple benefits. The hold downs provide for proper lead-to-pad registration and provide retention to the PC board prior to and during processing. Used with a plated thru-hole, the hold

downs are soldered during the reflow process and serve as a strain relief for the solder joints during mating/unmating.

The design of the hold downs results in an excellent ratio of insertion/extraction forces (into the PC board); 20 lb. [89 N] maximum insertion force per pair and 10 lb. [44.5 N] minimum extraction force per pair (unsoldered). No tools are required for insertion.

---

**Mod IV Surface Mount Vertical Receptacle Assemblies,  
.100 x .100 [2.54 x 2.54] Centerline** (Continued)

---

**Performance Specifications****Voltage Rating:** 250 VAC**Current Rating:** 3.0 amperes (max.) for single contact;  
2.0 amperes (max.) per contact when connector is fully energized**Operating Temperature Range (Receptacle Assemblies):** -65°C to +125°C**Operating Temperature Range (Headers):** -65°C to +105°C**Dielectric Withstanding Voltage:** 750 VAC**Termination Resistance:** 12 milliohms (max.)**Insulation Resistance:** 5000 megohms (min.)**Mating Force (Receptacle Assemblies):** 9.0 oz. [2.50N] (max.) per contact**Unmating Force (Receptacle Assemblies):** 1.5 oz. [0.42N] (min.) per contact**Durability:** Tested to 200 cycles (min.) for .000030 [0.00076] gold plated contacts

## Mod IV Receptacle Assemblies, Single-Row, Surface Mount, .100 [2.54] Centerline with Compliant Pin Hold Downs

### Surface Mount, Single-Row, Dual Entry with Compliant Pin Holddowns

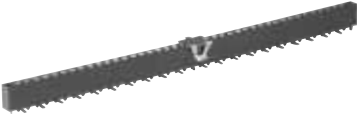

#### Material and Finish

**Housing** — Glass-filled thermoplastic, black, 94V-0 rated

**Contacts** — Phosphor bronze, plated as follows:

**Plating A** — Duplex .000030 [0.00076] gold on contact area, .000150-.000300 [0.00381-0.00762] matte tin on solder area all over .000050 [0.00127] nickel

**Plating B** — Duplex .000010 [0.000254] gold on contact area, .000150-.000300 [0.00381-0.00762] matte tin on solder area all over .000050 [0.00127] nickel

**Plating C** — .000150-.000300 [0.00381-0.00762] matte tin on solder leads, all over .000050 [0.00127] nickel

#### Related Product Data

**Mateable Headers** — Refer to Mating Post Selection Guide — page 90

**Performance Specifications** — page 186

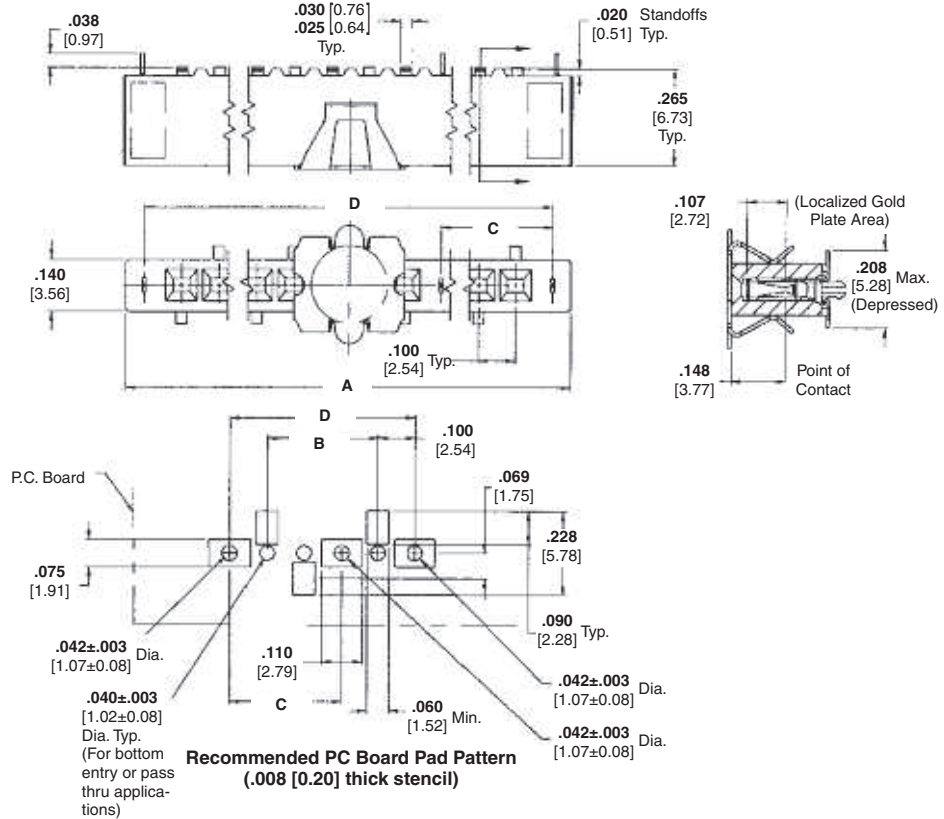

No. of Pos.	Dimensions				Packaged in Tubes			Packaged in Tape & Reel		
	A	B	C	D	Contact Plating/ Part Nos.			Contact Plating/ Part Nos.		
					Plating A	Plating B	Plating C	Plating A	Plating B	Plating C
3	.500 [12.70]	.200 [5.08]	See note 3	.400 [10.16]	5-147744-1	5-147743-1	5-147742-1	5-147724-1	5-147730-1	5-147731-1
4	.600 [15.24]	.300 [7.62]	See note 3	.500 [12.70]	5-147744-2	5-147743-2	5-147742-2	5-147724-2	5-147730-2	5-147731-2
5	.700 [17.78]	.400 [10.16]	See note 3	.600 [15.24]	5-147744-3	5-147743-3	5-147742-3	5-147724-3	5-147730-3	5-147731-3
6	.800 [20.32]	.500 [12.70]	See note 3	.700 [17.78]	5-147744-4	5-147743-4	5-147742-4	5-147724-4	5-147730-4	5-147731-4
7	.900 [22.86]	.600 [15.24]	See note 3	.800 [20.32]	5-147744-5	5-147743-5	5-147742-5	5-147724-5	5-147730-5	5-147731-5
8	1.000 [25.40]	.700 [17.78]	See note 3	.900 [22.86]	5-147744-6	5-147743-6	5-147742-6	5-147724-6	5-147730-6	5-147731-6
9	1.100 [27.94]	.800 [20.32]	See note 3	1.000 [25.40]	5-147744-7	5-147743-7	5-147742-7	5-147724-7	5-147730-7	5-147731-7
10	1.200 [30.48]	.900 [22.86]	See note 3	1.100 [27.94]	5-147744-8	5-147743-8	5-147742-8	5-147724-8	5-147730-8	5-147731-8
11	1.300 [33.02]	1.000 [25.40]	See note 3	1.200 [30.48]	5-147744-9	5-147743-9	5-147742-9	5-147724-9	5-147730-9	5-147731-9
12	1.400 [35.56]	1.100 [27.94]	See note 3	1.300 [33.02]	6-147744-0	6-147743-0	6-147742-0	6-147724-0	6-147730-0	6-147731-0
13	1.500 [38.10]	1.200 [30.48]	See note 3	1.400 [35.56]	6-147744-1	6-147743-1	6-147742-1	6-147724-1	6-147730-1	6-147731-1
14	1.600 [40.64]	1.300 [33.02]	See note 3	1.500 [38.10]	6-147744-2	6-147743-2	6-147742-2	6-147724-2	6-147730-2	6-147731-2
15	1.700 [43.18]	1.400 [35.56]	See note 3	1.600 [40.64]	6-147744-3	6-147743-3	6-147742-3	6-147724-3	6-147730-3	6-147731-3
16	1.800 [45.72]	1.500 [38.10]	See note 3	1.700 [43.18]	6-147744-4	6-147743-4	6-147742-4	6-147724-4	6-147730-4	6-147731-4
17	1.900 [48.26]	1.600 [40.64]	See note 3	1.800 [45.72]	6-147744-5	6-147743-5	6-147742-5	6-147724-5	6-147730-5	6-147731-5
18	2.000 [50.80]	1.700 [43.18]	See note 3	1.900 [48.26]	6-147744-6	6-147743-6	6-147742-6	6-147724-6	6-147730-6	6-147731-6
19	2.100 [53.34]	1.800 [45.72]	See note 3	2.000 [50.80]	6-147744-7	6-147743-7	6-147742-7	6-147724-7	6-147730-7	6-147731-7
20	2.200 [55.88]	1.900 [48.26]	See note 3	2.100 [53.34]	6-147744-8	6-147743-8	6-147742-8	6-147724-8	6-147730-8	6-147731-8
30	3.200 [81.28]	2.900 [73.66]	See note 3	3.100 [78.74]	7-147744-8	7-147743-8	7-147742-8	7-147724-8	7-147730-8	7-147731-8
40	4.300 [109.22]	4.100 [104.14]	2.100 [53.34]	4.200 [106.68]	8-147744-8	8-147743-8	8-147742-8	8-147724-8	8-147730-8	8-147731-8

- Notes:**
1. TE recommends mating gold or duplex plated headers with duplex plated receptacle assemblies.
  2. To obtain the minimum mating post length, add .020 [0.51] (not including the post lead in chamfer) to the maximum point-of-contact dimension, and .062 [1.57] for recommended board thickness if used in bottom entry application
  3. No center hold down.

**Note:** All part numbers are RoHS compliant.

## Mod IV Receptacle Assemblies, Single-Row, Surface Mount, .100 [2.54] x .100 [2.54] Centerline End To End Stackable without Compliant Pin Holdowns

### Surface Mount, Single-Row, Dual Entry, End to End Stackable

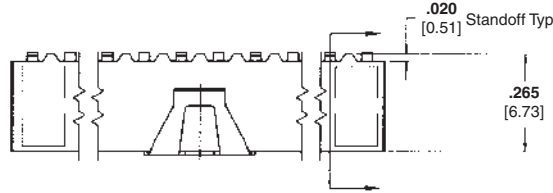

#### Material and Finish

**Housing** — Glass-filled thermoplastic, black, 94V-0 rated

**Contacts** — Phosphor bronze, plated as follows:

**Plating A** — Duplex .000030 [0.00076] gold on contact area, .000150-.000300 [0.00381-0.00762] matte tin on solder area all over .000050 [0.00127] nickel

**Plating B** — Duplex .000010 [0.000254] gold on contact area, .000150-.000300 [0.00381-0.00762] matte tin on solder area all over .000050 [0.00127] nickel

**Plating C** — .000150-.000300 [0.00381-0.00762] matte tin on solder leads, all over .000050 [0.00127] nickel

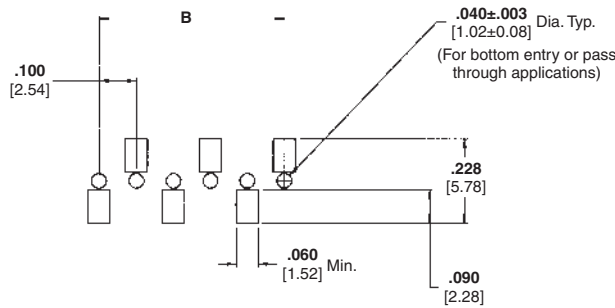
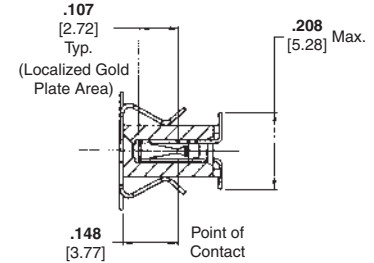
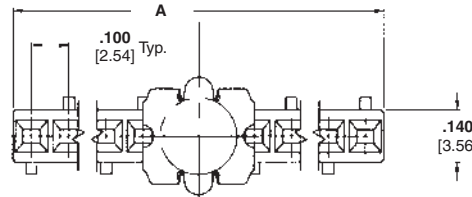

Recommended PC Board Pad Pattern (.008 [0.20] thick stencil)

#### Related Product Data

**Mateable Headers** — Refer to Mating Post Selection Guide — page 90

**Performance Specifications** — page 186

No. of Pos.	Dimensions		Packaged in Tubes			Packaged in Tape & Reel		
	A	B	Contact Plating/ Part Nos.			Contact Plating/ Part Nos.		
			Plating A	Plating B	Plating C	Plating A	Plating B	Plating C
3	.300 [7.62]	.200 [5.08]	5-147738-2	5-147737-2	5-147736-2	5-147723-2	5-147728-2	5-147729-2
4	.400 [10.16]	.300 [7.62]	5-147738-3	5-147737-3	5-147736-3	5-147723-3	5-147728-3	5-147729-3
5	.500 [12.70]	.400 [10.16]	5-147738-4	5-147737-4	5-147736-4	5-147723-4	5-147728-4	5-147729-4
6	.600 [15.24]	.500 [12.70]	5-147738-5	5-147737-5	5-147736-5	5-147723-5	5-147728-5	5-147729-5
7	.700 [17.78]	.600 [15.24]	5-147738-6	5-147737-6	5-147736-6	5-147723-6	5-147728-6	5-147729-6
8	.800 [20.32]	.700 [17.78]	5-147738-7	5-147737-7	5-147736-7	5-147723-7	5-147728-7	5-147729-7
9	.900 [22.86]	.800 [20.32]	5-147738-8	5-147737-8	5-147736-8	5-147723-8	5-147728-8	5-147729-8
10	1.000 [25.40]	.900 [22.86]	5-147738-9	5-147737-9	5-147736-9	5-147723-9	5-147728-9	5-147729-9
11	1.100 [27.94]	1.000 [25.40]	6-147738-0	6-147737-0	6-147736-0	6-147723-0	6-147728-0	6-147729-0
12	1.200 [30.48]	1.100 [27.94]	6-147738-1	6-147737-1	6-147736-1	6-147723-1	6-147728-1	6-147729-1
13	1.300 [33.02]	1.200 [30.48]	6-147738-2	6-147737-2	6-147736-2	6-147723-2	6-147728-2	6-147729-2
14	1.400 [35.56]	1.300 [33.02]	6-147738-3	6-147737-3	6-147736-3	6-147723-3	6-147728-3	6-147729-3
15	1.500 [38.10]	1.400 [35.56]	6-147738-4	6-147737-4	6-147736-4	6-147723-4	6-147728-4	6-147729-4
16	1.600 [40.64]	1.500 [38.10]	6-147738-5	6-147737-5	6-147736-5	6-147723-5	6-147728-5	6-147729-5
17	1.700 [43.18]	1.600 [40.64]	6-147738-6	6-147737-6	6-147736-6	6-147723-6	6-147728-6	6-147729-6
18	1.800 [45.72]	1.700 [43.18]	6-147738-7	6-147737-7	6-147736-7	6-147723-7	6-147728-7	6-147729-7
19	1.900 [48.26]	1.800 [45.72]	6-147738-8	6-147737-8	6-147736-8	6-147723-8	6-147728-8	6-147729-8
20	2.000 [50.80]	1.900 [48.26]	6-147738-9	6-147737-9	6-147736-9	6-147723-9	6-147728-9	6-147729-9
30	3.000 [76.20]	2.900 [73.66]	7-147738-9	7-147737-9	7-147736-9	7-147723-9	7-147728-9	7-147729-9
40	4.000 [101.60]	3.900 [99.06]	8-147738-9	8-147737-9	8-147736-9	8-147723-9	8-147728-9	8-147729-9

- Notes:** 1. TE recommends mating gold or duplex plated headers with duplex plated receptacle assemblies.  
 2. To obtain the minimum mating post length, add .020 [0.51] (not including the post lead in chamfer) to the maximum point-of-contact dimension, and .062 [1.57] for recommended board thickness if used in bottom entry application.

**Note:** All part numbers are RoHS compliant.

## Mod IV Surface Mount Receptacle Assemblies, Double-Row, .100 x .100 [2.54 x 2.54] Centers

### Surface Mount, Double Row, Dual Entry with Holddowns

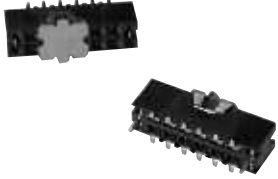

#### Material and Finish

**Housing** — Glass-filled thermoplastic, black, 94V-0 rated

**Contacts** — Phosphor bronze, plated as follows:

**Plating A** — Duplex .000030 [0.00076] gold on contact area, .000150-.000300 [0.00381-0.00762] matte tin on solder area all over .000050 [0.00127] nickel

**Plating B** — Duplex .000010 [0.000254] gold on contact area, .000150-.000300 [0.00381-0.00762] matte tin on solder area all over .000050 [0.00127] nickel

**Plating C** — .000150-.000300 [0.00381-0.00762] matte tin on solder leads, all over .000050 [0.00127] nickel

#### Related Product Data

**Mateable Headers** — Refer to Mating Post Selection Guide — page 90

**Performance Specifications** — page 186

**Technical Documents** — page 276

**Product Specification**  
108-25022

**Application Specification**  
114-25018

**Additional receptacle assembly sizes are available; minimum order quantities may apply. Consult TE.**

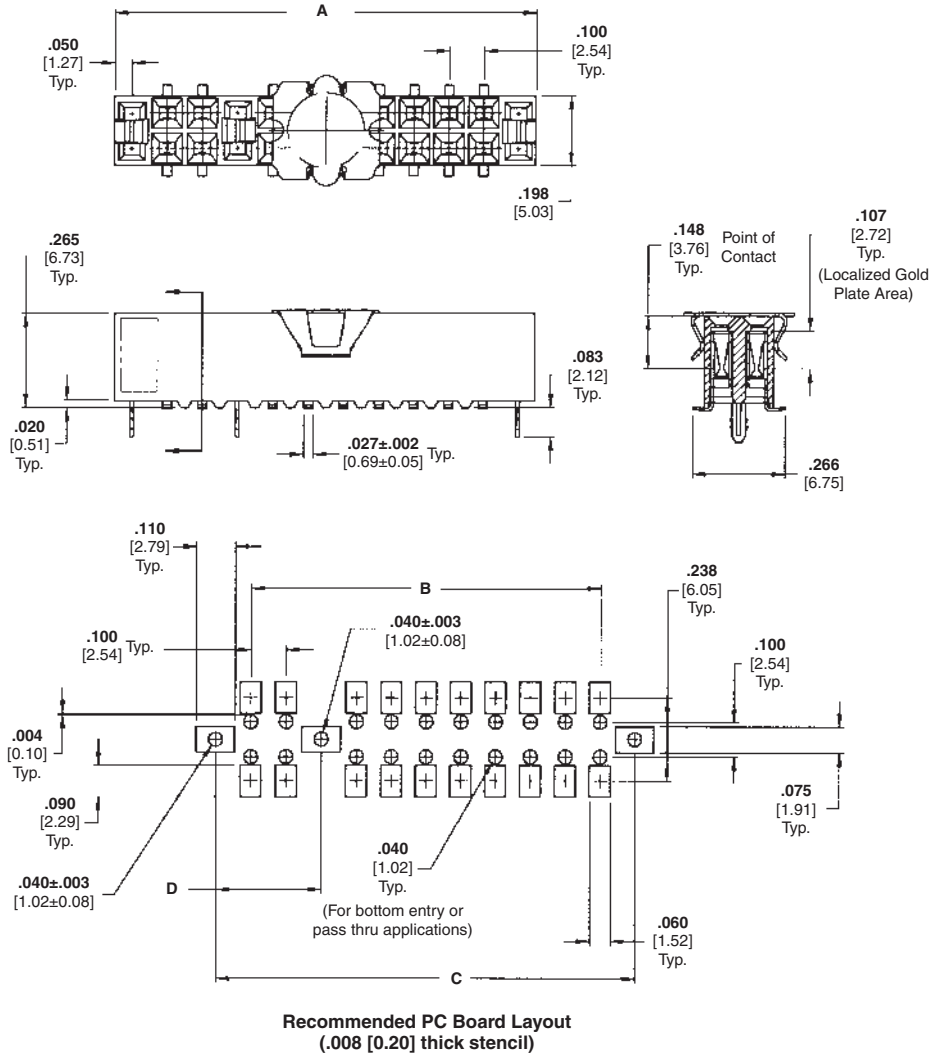

#### Keying Plug

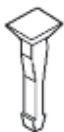

**Part No. 86286-1**  
(Plugs into receptacle contact)

**Material** — Natural color nylon

**Note:** All part numbers are RoHS compliant.

**Mod IV Surface Mount Receptacle Assemblies, Double-Row,  
.100 x .100 [2.54 x 2.54] Centers (Continued)**

No. of Pos.	Dimensions				D	Packaged in Tubes			Packaged in Tape and Reel		
	A	B	C	See Note 1		Contact Plating/Part Nos.			Contact Plating/Part Nos.		
						Plating A	Plating B	Plating C	Plating A	Plating B	Plating C
10	.700 [17.78]	.400 [10.16]	.600 [15.24]	See Note 1	5-147102-5	5-147101-5	5-147103-5	5-147747-5	5-147746-5	5-147745-5	
14	.900 [22.86]	.600 [15.24]	.800 [20.32]	See Note 1	5-147102-7	5-147101-7	5-147103-7	5-147747-7	5-147746-7	5-147745-7	
20	1.200 [30.48]	.900 [22.86]	1.100 [27.94]	See Note 1	6-147102-0	6-147101-0	6-147103-0	6-147747-0	6-147746-0	6-147745-0	
22	1.300 [33.02]	1.000 [25.40]	1.200 [30.48]	See Note 1	6-147102-1	6-147101-1	6-147103-1	6-147747-1	6-147746-1	6-147745-1	
26	1.500 [38.10]	1.200 [30.48]	1.400 [35.56]	See Note 1	6-147102-3	6-147101-3	6-147103-3	6-147747-3	6-147746-3	6-147745-3	
30	1.700 [43.18]	1.400 [35.56]	1.600 [40.64]	See Note 1	6-147102-5	6-147101-5	6-147103-5	6-147747-5	6-147746-5	6-147745-5	
34	1.900 [48.26]	1.600 [40.64]	1.800 [45.72]	See Note 1	6-147102-7	6-147101-7	6-147103-7	6-147747-7	6-147746-7	6-147745-7	
36	2.000 [50.08]	1.700 [43.18]	1.900 [48.26]	See Note 1	6-147102-8	6-147101-8	6-147103-8	6-147747-8	6-147746-8	6-147745-8	
40	2.200 [55.88]	1.900 [48.26]	2.100 [53.34]	See Note 1	7-147102-0	7-147101-0	7-147103-0	7-147747-0	7-147746-0	7-147745-0	
46	2.500 [63.50]	2.200 [55.88]	2.400 [60.96]	See Note 1	7-147102-3	7-147101-3	7-147103-3	7-147747-3	7-147746-3	7-147745-3	
50	2.700 [68.58]	2.400 [60.96]	2.600 [66.04]	See Note 1	7-147102-5	7-147101-5	7-147103-5	7-147747-5	7-147746-5	7-147745-5	
62	3.300 [83.82]	3.000 [76.20]	3.200 [81.28]	See Note 1	8-147102-1	8-147101-1	8-147103-1	8-147747-1	8-147746-1	8-147745-1	
64	3.400 [86.36]	3.100 [78.74]	3.300 [83.82]	See Note 1	8-147102-2	8-147101-2	8-147103-2	8-147747-2	8-147746-2	8-147745-2	
66	3.500 [88.90]	3.200 [81.28]	3.400 [86.36]	See Note 1	8-147102-3	8-147101-3	8-147103-3	8-147747-3	8-147746-3	8-147745-3	
70	3.700 [95.98]	3.400 [86.36]	3.600 [91.44]	See Note 1	8-147102-5	8-147101-5	8-147103-5	8-147747-5	8-147746-5	8-147745-5	
80	4.300 [109.22]	3.900 [99.06]	4.200 [106.68]	2.100 [53.34]	9-147102-0	9-147101-0	9-147103-0	9-147747-0	9-147746-0	9-147745-0	

- Notes:** 1. No center holddown.  
2. To obtain the minimum mating post length, add .020 [0.51] (not including the post lead in chamfer) to the maximum point-of-contact dimension and .062 [1.57] for recommended board thickness in bottom entry applications.

**Note:** All part numbers are RoHS compliant.

## Mod IV Surface Mount Receptacle Assemblies, Double-Row, .100 x .100 [2.54 x 2.54] Centerline

### Surface Mount, Double Row, Dual Entry End to End Stackable

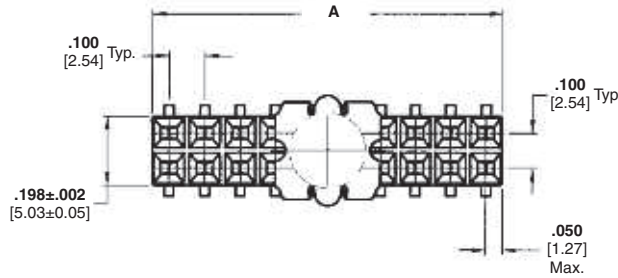
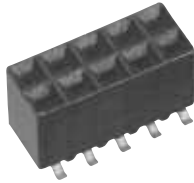

### Material and Finish

**Housing** — Glass-filled thermoplastic, black, 94V-0 rated

**Contacts** — Phosphor bronze, plated as follows:

**Plating A** — Duplex .000030 [0.00076] gold on contact area, .000150-.000300 [0.00381-0.00762] matte tin on solder area all over .000050 [0.00127] nickel

**Plating B** — Duplex .000010 [0.000254] gold on contact area, .000150-.000300 [0.00381-0.00762] matte tin on solder area all over .000050 [0.00127] nickel

**Plating C** — .000150-.000300 [0.00381-0.00762] tin-lead over .000050 [0.00127] nickel

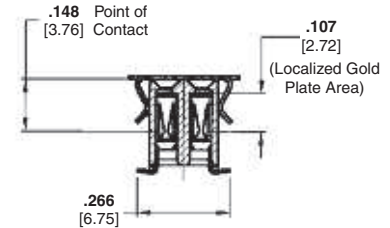
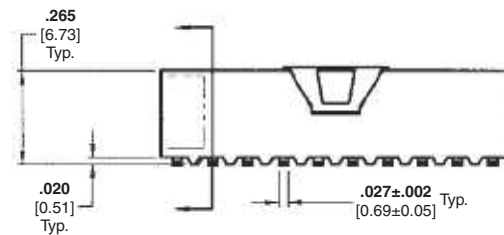

### Related Product Data

**Mateable Headers** — Refer to Mating Post Selection Guide — page 90

**Performance Specifications** — page 186

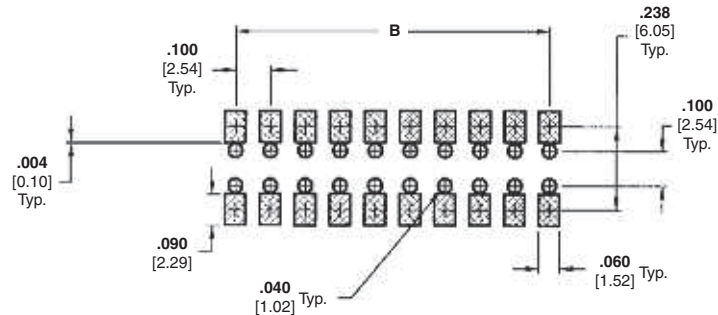

Recommended PC Board Pad Layout  
(.008 [0.20] thick stencil)  
(for Bottom Entry and Pass Through applications)

**Technical Documents** — page 276

**Product Specification**  
108-25022

**Application Specification**  
114-25018

**Additional receptacle assembly sizes are available; minimum order quantities may apply. Consult TE.**

### Keying Plug

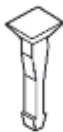

**Part No. 86286-1**  
(Plugs into receptacle contact)

**Material** — Natural color nylon

**Note:** All part numbers are RoHS compliant.

**Mod IV Surface Mount Receptacle Assemblies, Double-Row,  
.100 x .100 [2.54 x 2.54] Centerline** (Continued)

No. of Pos.	Dimensions		Packaged in Tubes			Packaged in Tape & Reel		
	A	B	Contact Plating/ Part Nos.			Contact Plating/ Part Nos.		
			Plating A	Plating B	Plating C	Plating A	Plating B	Plating C
10	.500 [12.70]	.400 [10.16]	5-147741-5	5-147740-5	5-147739-5	5-147105-5	5-147104-5	5-147106-5
14	.700 [17.78]	.600 [15.24]	5-147741-7	5-147740-7	5-147739-7	5-147105-7	5-147104-7	5-147106-7
20	1.000 [25.40]	.900 [22.86]	6-147741-0	6-147740-0	6-147739-0	6-147105-0	6-147104-0	6-147106-0
22	1.100 [27.94]	1.000 [25.40]	6-147741-1	6-147740-1	6-147739-1	6-147105-1	6-147104-1	6-147106-1
26	1.300 [33.02]	1.200 [30.48]	6-147741-3	6-147740-3	6-147739-3	6-147105-3	6-147104-3	6-147106-3
30	1.500 [38.10]	1.400 [35.56]	6-147741-5	6-147740-5	6-147739-5	6-147105-5	6-147104-5	6-147106-5
34	1.700 [43.18]	1.600 [40.64]	6-147741-7	6-147740-7	6-147739-7	6-147105-7	6-147104-7	6-147106-7
36	1.800 [45.72]	1.700 [43.18]	6-147741-8	6-147740-8	6-147739-8	6-147105-8	6-147104-8	6-147106-8
40	2.000 [50.80]	1.900 [48.26]	7-147741-0	7-147740-0	7-147739-0	7-147105-0	7-147104-0	7-147106-0
46	2.300 [58.42]	2.200 [55.88]	7-147741-3	7-147740-3	7-147739-3	7-147105-3	7-147104-3	7-147106-3
50	2.500 [63.50]	2.400 [60.96]	7-147741-5	7-147740-5	7-147739-5	7-147105-5	7-147104-5	7-147106-5
62	3.100 [78.74]	3.000 [76.20]	8-147741-1	8-147740-1	8-147739-1	8-147105-1	8-147104-1	8-147106-1
64	3.200 [81.28]	3.100 [78.74]	8-147741-2	8-147740-2	8-147739-2	8-147105-2	8-147104-2	8-147106-2
66	3.300 [83.82]	3.200 [81.28]	8-147741-3	8-147740-3	8-147739-3	8-147105-3	8-147104-3	8-147106-3
70	3.500 [88.90]	3.400 [86.36]	8-147741-5	8-147740-5	8-147739-5	8-147105-5	8-147104-5	8-147106-5
80	4.000 [101.60]	3.900 [99.06]	9-147741-0	9-147740-0	9-147739-0	9-147105-0	9-147104-0	9-147106-0

**Notes:** 1. To obtain the minimum mating post length, add .020 [0.51] (not including the post lead in chamfer) to the maximum point-of-contact dimension and .062 [1.57] for recommended board thickness in bottom entry applications.

**Note:** All part numbers are RoHS compliant.



## Two-Piece Printed Circuit Board Connectors

### Product Facts

- Two-Piece reliability
- Two- and three-row systems available
- Short signal path for VLSI applications
- Receptacles employ dual cantilever beams and built-in anti-overstress to provide reliable connections
- Built-in guides provide alignment before contact engagement
- Closed entry receptacle housings provide lead-in ramp for positive mating of contacts
- Shrouded headers provide full pin protection
- Polarized headers
- Vertical headers available with ACTION PIN posts or .025 [0.64] square solder posts
- Repairable ACTION PIN posts
- Simple seating tooling for headers with ACTION PIN posts
- Recognized under the Component Program of Underwriters Laboratories Inc., File No. E28476
- Certified by Canadian Standards Association, File No. LR 7189

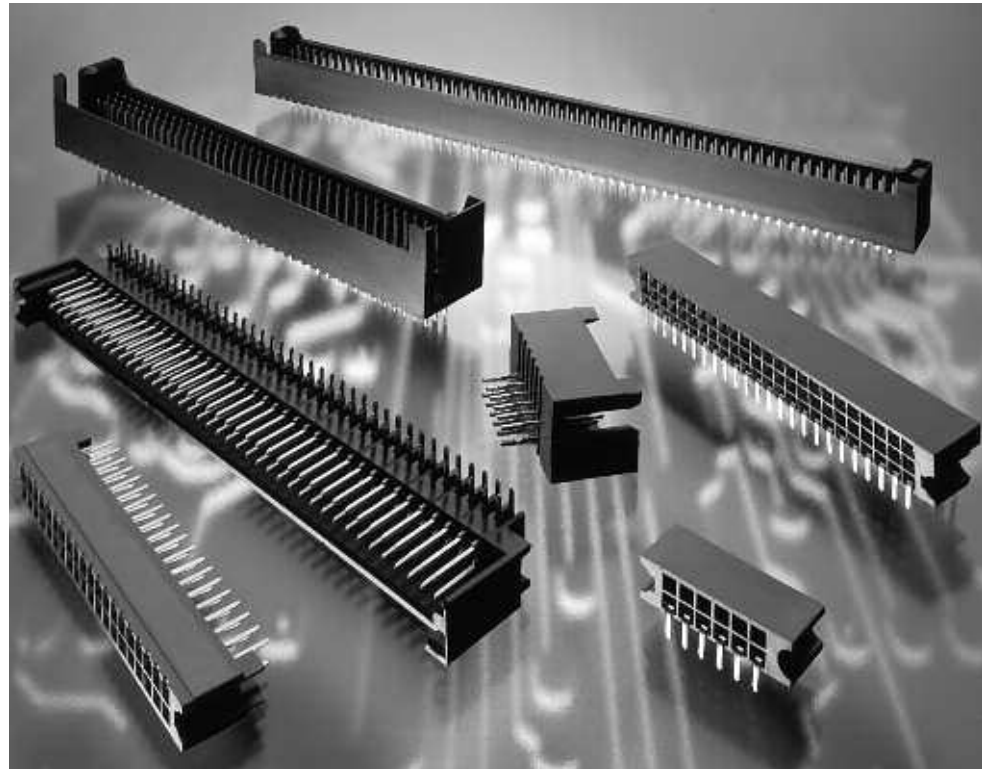

ACTION PIN Posts



Solder Posts



Receptacle Contact  
(Double Beam with Anti-Overstress)  
Board Retention Feature Available

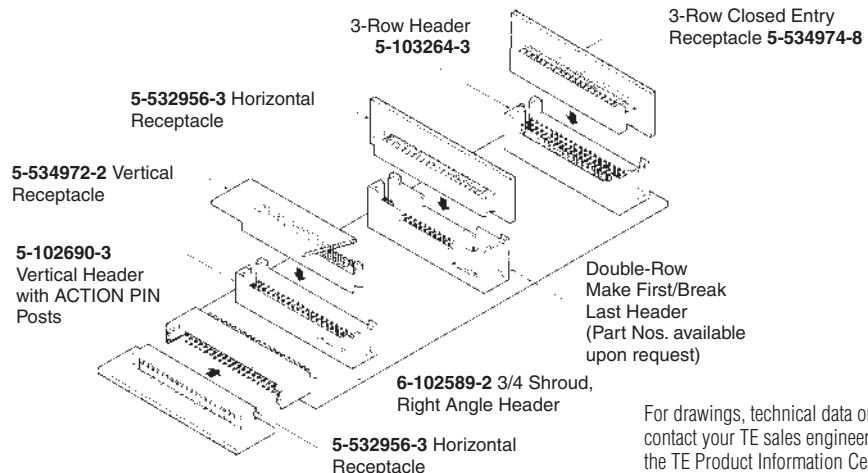

Note: All part numbers are RoHS compliant.

For drawings, technical data or samples, contact your TE sales engineer or call the TE Product Information Center: 1-800-522-6752

**Two-Piece Printed Circuit Board Connectors** (Continued)

AMPMODU Two-Piece Printed Circuit Board connectors are designed to reliably and economically meet the packaging and interconnection requirements of today's sophisticated electronics.

The double row system is produced in 10 thru 200 positions in the vertical headers and horizontal receptacles, and 10 thru 160 positions in the right angle headers and vertical receptacles.

The AMPMODU three-row connector system is produced in 30 through 300 positions (straight post headers and mating horizontal receptacles).

Both two- and three-row vertical headers are available with press-fit ACTION PIN posts or standard .025 [0.64] square solder posts. There is a simple seating tool for headers with ACTION PIN posts.

A board retention feature is offered in the two-row horizontal receptacles, two-row right angle headers and two- and three-row vertical headers. Built-in guides assure accurate header and receptacle alignment before contact engagement.

Closed entry receptacle housings provide a lead-in ramp for positive mating of contacts.

**Performance Specifications**

- Current Rating** — 3 amperes max. for single contact; 2 amperes max. per contact for fully energized connector
- Voltage Rating** — 250 VAC
- Dielectric Rating** — 750 VAC rms between contacts for one minute
- Termination Resistance** — 12 milliohms max. at 100 milliamperes test current, and 50 millivolts open circuit voltage
- Insulation Resistance** — 1000 megohms after temperature/humidity cycling

- Temperature Rating** — Headers and Receptacles — -65°C to +125°C (black thermoplastic housings, 94V-0 rated)
- Durability (Tested to)** — 200 cycles for .000030 [0.00076] gold plating; 75 cycles for .000015 [0.00038] gold plating
- Mating Force** — 8 oz. [2.22N] maximum per contact
- Unmating Force** — .75 oz. [0.2N] minimum per contact during third mating cycle

## Receptacle Assemblies, Board Mount, Double-Row, Closed Entry, .100 x .100 [2.54 x 2.54] Centerline

### Horizontal Mount (with Guide Pin Slots and Standoffs)



#### Material and Finish

**Housing** — Glass-filled thermoplastic, black, 94V-0 rated

**Contacts** — Phosphor bronze, plated as follows:

**Plating A** — Duplex plated .000030 [0.00076] gold on contact area, .000050-.000100 [0.00127-0.00254] matte tin on solder area, with entire contact underplated .000050 [0.00127] nickel

**Plating B** — Duplex plated .000015 [0.00038] gold on contact area, .000050-.000100 [0.00127-0.00254] matte tin on solder area, with entire contact underplated .000050 [0.00127] nickel

#### Related Product Data

**Mateable Headers** — pages 198, 199

**Performance Specifications** — page 194

**Technical Documents** — page 276

#### Product Specification

108-25017

#### Application Specification

114-9009

**Additional receptacle assembly sizes and solder tail lengths are available; minimum order quantities may apply. Consult TE.**

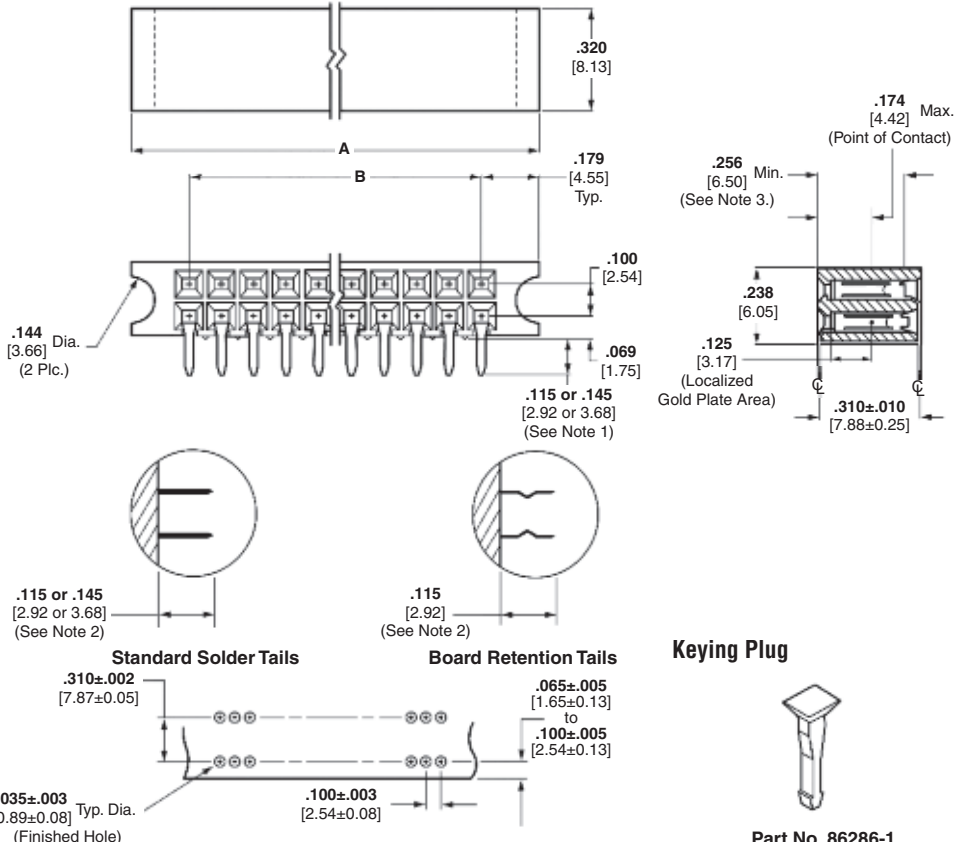

#### Recommended PC Board Hole Layout (for .055 [1.40] min. thick PC board)

Tolerances not to accumulate within one connector pattern.

#### Keying Plug

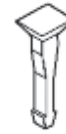

Part No. 86286-1

(Plugs into receptacle contact)

Material — Natural color nylon

No. of Pos.	Dimensions		Receptacle Assembly Part Nos. with .115 [2.92] Solder Tail Lengths				Receptacle Assembly Part Nos. with .145 [3.68] Solder Tail Lengths
	A	B	Standard Solder Tails		Board Retention Tails		Standard Solder Tails
			Plating A	Plating B	Plating A	Plating B	
12	.858 [21.79]	.500 [12.70]	5-532956-1	5-532955-1	5-534204-2	5-534975-5	5-533009-1
14	.958 [24.33]	.600 [15.24]	—	7-532955-5	—	—	—
16	1.058 [26.87]	.700 [17.78]	5-532956-2	—	6-534204-0	6-534975-5	—
20	1.258 [31.95]	.900 [22.86]	5-532956-3	5-532955-3	5-534204-9	5-534975-6	—
24	1.458 [37.03]	1.100 [27.94]	5-532956-4	5-532955-4	6-534204-1	5-534975-7	—
30	1.758 [44.65]	1.400 [35.56]	5-532956-5	5-532955-5	5-534204-4	5-534975-8	5-533009-5
36	2.058 [52.27]	1.700 [43.18]	5-532956-6	5-532955-6	5-534204-3	5-534975-9	—
40	2.258 [57.35]	1.900 [48.26]	5-532956-7	5-532955-7	6-534204-2	6-534975-0	—
50	2.758 [70.05]	2.400 [60.96]	5-532956-8	5-532955-8	5-534204-1	6-534975-1	5-533009-8
60	3.258 [82.75]	2.900 [73.66]	5-532956-9	5-532955-9	5-534204-5	6-534975-2	5-533009-9
70	3.758 [95.45]	3.400 [86.36]	6-532956-0	6-532955-0	6-534204-3	6-534975-3	6-533009-0
72	3.858 [97.99]	3.500 [88.90]	6-532956-1	6-532955-1	6-534204-4	—	—
80	4.258 [108.15]	3.900 [99.06]	6-532956-2	6-532955-2	5-534204-8	6-534975-4	6-533009-2
86	4.558 [115.77]	4.200 [106.68]	6-532956-3	6-532955-3	—	—	6-533009-3
90	4.758 [120.85]	4.400 [111.76]	6-532956-4	6-532955-4	—	—	—
96	5.058 [128.47]	4.700 [119.38]	6-532956-5	6-532955-5	6-534204-5	—	6-533009-5
100	5.258 [133.55]	4.900 [124.46]	6-532956-6	6-532955-6	5-534204-6	5-534975-1	6-533009-6
110	5.758 [146.25]	5.400 [137.16]	6-532956-7	6-532955-7	6-534204-6	—	—
120	6.258 [158.95]	5.900 [149.86]	6-532956-8	6-532955-8	5-534204-7	5-534975-2	6-533009-8
130	6.758 [171.65]	6.400 [162.56]	7-532956-0	7-532955-0	6-534204-7	—	—
200	10.258 [260.55]	9.900 [251.46]	7-532956-3	7-532955-3	7-534204-0	5-534975-4	—

- Notes:** 1. .115 [2.92] tail length is for use with .062 [1.57] PC boards; .145 [3.68] tail length is for use with .093 [2.36] PC boards.  
 2. Receptacle assemblies with low force contacts are available, consult TE.  
 3. .256 [6.50] minimum positive pin stop to prevent shorting between rows.

**Note:** All part numbers are RoHS compliant.

## Receptacle Assemblies, Board Mount, Double-Row, Closed Entry, .100 x .100 [2.54 x 2.54] Centerline (Continued)

### Vertical Mount (with Guide Pin Slots and Standoffs)

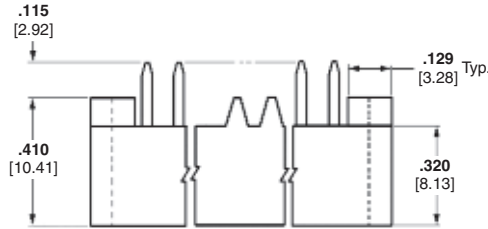
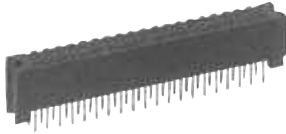

### Material and Finish

**Housing** — Glass-filled thermoplastic, black, 94V-0 rated

**Contacts** — Phosphor bronze, duplex plated .000030 [0.00076] gold on contact area, .000050-.000100 [0.00127-0.00254] matte tin on solder area, with entire contact underplated .000050 [0.00127] nickel

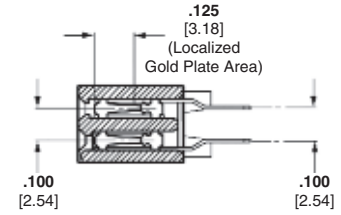
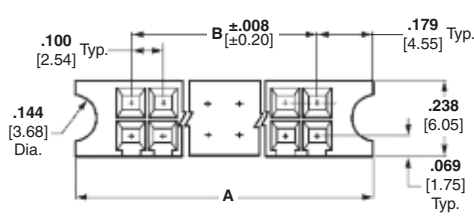

### Related Product Data

**Mateable Headers** — pages 198, 199

**Performance Specifications** — page 194

**Technical Documents** — page 276

**Product Specification**  
108-25017

**Application Specification**  
114-9009

**Additional receptacle assembly sizes and solder tail lengths are available; minimum order quantities may apply. Consult TE.**

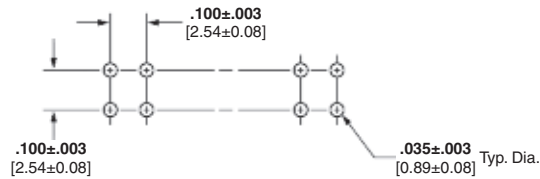

### Recommended PC Board Hole Layout (for .055 [1.40] min. thick PC board)

Tolerances not to accumulate within one connector pattern.

### Keying Plug

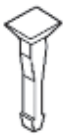

**Part No. 86286-1**

(Plugs into receptacle contact)

**Material** — Natural color nylon

No. of Pos.	Dimensions		Receptacle Assembly Part Nos.
	A	B	
30	1.758 [44.65]	1.400 [35.56]	5-534972-1
40	2.258 [57.35]	1.900 [48.26]	5-534972-2
50	2.758 [70.05]	2.400 [60.96]	5-534972-3
60	3.258 [82.75]	2.900 [73.66]	5-534972-4
70	3.758 [95.45]	3.400 [86.36]	5-534972-5
80	4.258 [108.15]	3.900 [99.06]	5-534972-6
90	4.758 [120.85]	4.400 [111.76]	5-534972-7
100	5.258 [133.55]	4.900 [124.46]	5-534972-8
120	6.258 [158.95]	5.900 [149.86]	6-534972-0

**Note:** All part numbers are RoHS compliant.

## Receptacle Assemblies, Board Mount, Triple-Row, Closed Entry, .100 x .100 [2.54 x 2.54] Centerline

### Horizontal Mount (with Guide Pin Slots and Standoffs)

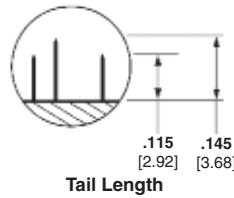
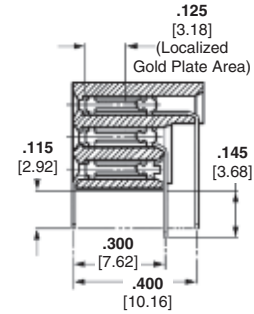
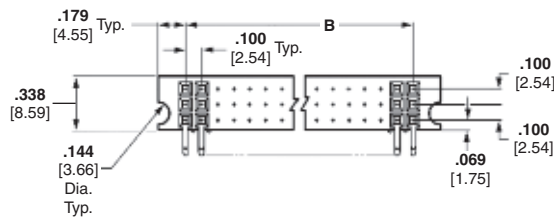
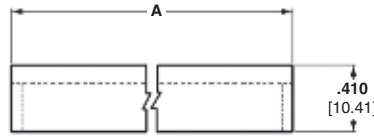

### Material and Finish

**Housing** — Glass-filled thermoplastic, black, 94V-0 rated

**Contacts** — Phosphor bronze, plated .000030 [0.00076] gold in mating area, .000050-.000100 [0.00127-0.00254] matte tin on solder area, with entire contact underplated .000050 [0.00127] nickel

### Related Product Data

**Mateable Headers** — page 201

**Performance Specifications** — page 194

**Technical Documents** — page 276

**Product Specification**  
108-25017

**Application Specification**  
114-9009

**Additional receptacle assembly sizes and solder tail lengths are available; minimum order quantities may apply. Consult TE.**

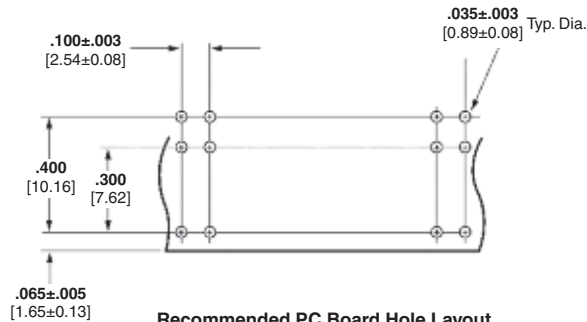

**Recommended PC Board Hole Layout**  
(for .055 [1.40] min. thick PC board)

Tolerances not to accumulate within one connector pattern.

No. of Pos.	Dimensions		Receptacle Assembly Part Nos. Plating A
	A	B	
72	2.658 [67.51]	2.300 [58.42]	5-534974-3
93	3.358 [85.29]	3.000 [76.20]	5-534974-4
96	3.458 [87.83]	3.100 [78.74]	5-534974-5
150	5.258 [133.55]	4.900 [124.46]	5-534974-8
210	7.258 [184.35]	6.900 [175.26]	6-534974-1

### Keying Plug

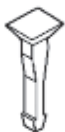

**Part No. 86286-1**

(Plugs into receptacle contact)

**Material** — Natural color nylon

**Note:** All part numbers are RoHS compliant.

## Headers, Straight Post, Double-Row, .100 x .100 [2.54 x 2.54] Centerline

### Solder Posts and ACTION PIN Posts (with Pin Protection and Guide Pins)



#### Material and Finish

**Housing** — Glass-filled thermoplastic, black, 94V-0 rated

**Posts** — Phosphor bronze, plated as follows:

**Plating A** — Duplex plated .000030 [0.00076] gold on contact area, .000100-.000200 [0.00254-0.00508] matte tin on termination end, with entire post underplated .000050 [0.00127] nickel

**Plating B** — Duplex plated .000015 [0.00038] gold on contact area, .000100-.000200 [0.00254-0.00508] matte tin on termination end, with entire post underplated .000050 [0.00127] nickel

**Plating C** — Selectively plated .000030 [0.00076] gold on contact area and .000015 [0.00038] gold on termination end, with gold flash over .000050 [0.00127] nickel on entire post

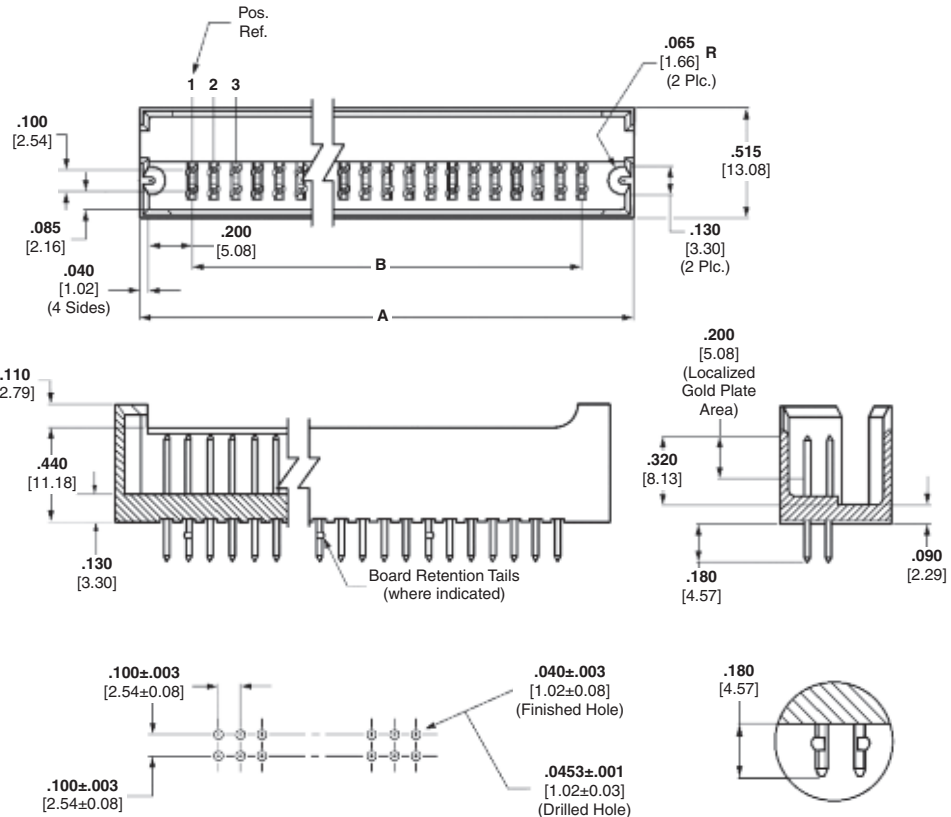

**Recommended PC Board Hole Layout (for .055 [1.40] min. thick PC board)**

Tolerances not to accumulate within one connector pattern.

#### Related Product Data

**Mateable Receptacles** — pages 195, 196

**Performance Specifications** — page 194

**ACTION PIN Posts** — pages 150, 151

**Application Tooling** — pages 152

**Technical Documents** — page 276

#### Product Specification

108-25017

#### Application Specification

114-9009

**Additional header sizes are available; minimum order quantities may apply. Consult TE.**

No. of Pos.	Dimensions		Header Part Nos. with .180 [4.57] Tail Length			
	A	B	Standard Solder Tails		Board Retention Tails	
			Plating A	Plating B	Plating A	Plating B
12	.980 [24.89]	.500 [12.70]	5-102692-1	5-102567-1	6-534978-6	5-534257-5
14	1.080 [27.43]	.600 [15.24]	—	7-102567-3	—	—
16	1.180 [29.97]	.700 [17.78]	6-102692-5	—	5-534978-2	6-534257-4
20	1.380 [35.05]	.900 [22.86]	6-102692-6	6-102567-1	5-534978-3	5-534257-6
24	1.580 [40.13]	1.100 [27.94]	5-102692-2	5-102567-2	5-534978-4	5-534257-7
30	1.880 [47.75]	1.400 [35.56]	6-102692-7	6-102567-3	5-534978-5	5-534257-8
36	2.180 [55.37]	1.700 [43.18]	5-102692-3	5-102567-3	5-534978-6	5-534257-9
40	2.380 [60.45]	1.900 [48.26]	6-102692-3	6-102567-2	5-534978-7	6-534257-0
50	2.880 [73.15]	2.400 [60.96]	5-102692-4	5-102567-6	5-534978-8	6-534257-5
60	3.380 [85.85]	2.900 [73.66]	5-102692-5	5-102567-4	5-534978-9	6-534257-1
70	3.880 [98.55]	3.400 [86.36]	6-102692-4	6-102567-0	6-534978-5	6-534257-2
72	3.980 [101.09]	3.500 [88.90]	6-102692-8	6-102567-6	6-534978-0	—
80	4.380 [111.25]	3.900 [99.06]	5-102692-6	5-102567-8	6-534978-1	5-534257-1
86	4.680 [118.87]	4.200 [106.68]	6-102692-9	6-102567-7	—	—
90	4.880 [123.95]	4.400 [111.76]	6-102692-2	6-102567-4	—	—
96	5.180 [131.57]	4.700 [119.38]	5-102692-7	5-102567-5	6-534978-7	—
100	5.380 [136.65]	4.900 [124.46]	5-102692-8	5-102567-9	6-534978-8	5-534257-2
110	5.880 [149.35]	5.400 [137.16]	6-102692-0	6-102567-5	6-534978-2	—
120	6.380 [162.05]	5.900 [149.86]	5-102692-9	5-102567-7	6-534978-3	5-534257-3
130	6.880 [174.75]	6.400 [162.56]	7-102692-0	6-102567-9	6-534978-9	—
200	10.380 [263.65]	9.900 [251.46]	6-102692-1	7-102567-1	5-534978-1	6-534257-9

**Note:** Headers with make first/break last posts can be made available, consult TE.

**Note:** All part numbers are RoHS compliant.

Printed Circuit Board Connectors

5

## Headers, Straight Post, Double-Row, .100 x .100 [2.54 x 2.54] Centerline (Continued)

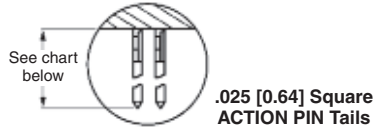

No. of Pos.	Dimensions		Header Part Nos. with ACTION PIN Posts				
	A	B	.250 [6.35] Tail Length		.480 [12.19] Tail Length		.680 [17.27] Tail Length
			Plating A	Plating B	Plating A	Plating C	Plating C
12	.980 [24.89]	.500 [12.70]	5-102690-1	5-103291-4	—	—	—
14	1.080 [27.43]	.600 [15.24]	—	5-103291-3	—	—	—
20	1.380 [35.05]	.900 [22.86]	6-102690-3	5-103291-6	—	—	—
24	1.580 [40.13]	1.100 [27.94]	5-102690-2	5-103291-7	—	—	—
36	2.180 [55.37]	1.700 [43.18]	5-102690-3	5-103291-9	—	—	—
40	2.380 [60.45]	1.900 [48.26]	6-102690-6	5-103291-2	—	—	—
50	2.880 [73.15]	2.400 [60.96]	5-102690-4	6-103291-0	—	—	—
60	3.380 [85.85]	2.900 [73.66]	5-102690-5	6-103291-1	—	—	—
70	3.880 [98.55]	3.400 [86.36]	6-102690-7	6-103291-2	—	—	—
80	4.380 [111.25]	3.900 [99.06]	5-102690-6	6-103291-4	—	—	—
90	4.880 [123.95]	4.400 [111.76]	6-102690-1	6-103291-6	—	—	—
96	5.180 [131.57]	4.700 [119.38]	5-102690-7	6-103291-8	—	—	—
100	5.380 [136.65]	4.900 [124.46]	5-102690-8	6-103291-9	—	—	102777-3
120	6.380 [162.05]	5.900 [149.86]	5-102690-9	7-103291-1	5-102691-9	1-102666-1	102777-1
130	6.880 [174.75]	6.400 [162.56]	—	—	—	102666-9	—

- Notes:** 1. Other header sizes can be made available upon request.  
 Headers with ACTION PIN posts are for use with .093 [2.36] nominal or thicker PC boards.  
 2. Application tooling for installing headers with ACTION PIN posts is shown on pages 152 and 153.  
 3. Headers with .250 [6.35] tail length can be made available with make first/break last contacts, consult TE.  
 4. Plated through holes to be prepared per recommendations found on page 151.

## Headers, Right-Angle Post, Double-Row, .100 x .100 [2.54 x 2.54] Centerline

### Card Extender (with Pin Protection and Guide Pins)



### Material and Finish

**Housing** — Glass-filled thermoplastic, black, 94V-0 rated

**Posts** — Phosphor bronze, plated as follows:

**Plating A** — Duplex plated .000030 [0.00076] gold on contact area, .000100-.000200 [0.00254-0.00508] matte tin on termination end, with entire post underplated .000050 [0.00127] nickel

**Plating B** — Duplex plated .000015 [0.00038] gold on contact area, .000100-.000200 [0.00254-0.00508] matte tin on termination end, with entire post underplated .000050 [0.00127] nickel

### Related Product Data

**Mateable Receptacles** — pages 195, 196

**Performance Specifications** — page 194

**Technical Documents** — page 276

**Product Specification**  
108-25017

**Application Specification**  
114-9009

**Additional header sizes are available; minimum order quantities may apply. Consult TE.**

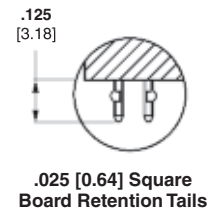
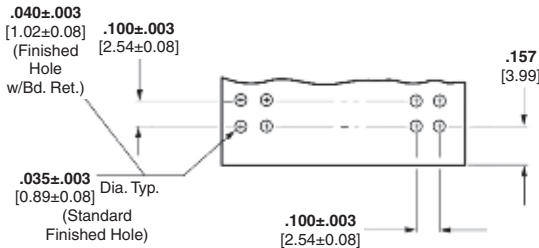
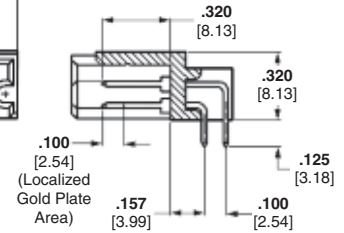
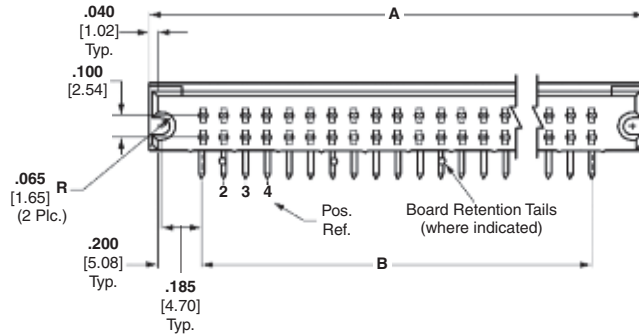

**Recommended PC Board Hole Layout (for .055 [1.40] min. thick PC board)**

Tolerances not to accumulate within one connector pattern.

No. of Pos.	Dimensions		Header Part Nos. with .125 [3.18] Tail Length		
	A	B	Standard Solder Tails		Board Retention Tails
			Plating A	Plating B	Plating A
12	.980 [24.89]	.500 [12.70]	6-102802-2	5-102589-8	5-534245-5
16	1.180 [29.97]	.700 [17.78]	6-102802-4	—	5-534245-4
20	1.380 [35.05]	.900 [22.86]	6-102802-5	6-102589-2	5-534245-6
24	1.580 [40.13]	1.100 [27.94]	6-102802-3	5-102589-6	5-534245-7
30	1.880 [47.75]	1.400 [35.56]	6-102802-6	5-102589-4	5-534245-2
36	2.180 [55.37]	1.700 [43.18]	5-102802-3	5-102589-2	5-534245-8
40	2.380 [60.45]	1.900 [48.26]	5-102802-8	6-102589-3	—
50	2.880 [73.15]	2.400 [60.96]	5-102802-4	5-102589-5	5-534245-1
60	3.380 [85.85]	2.900 [73.66]	5-102802-9	5-102589-7	—
72	3.980 [101.09]	3.500 [88.90]	6-102802-7	6-102589-7	—
80	4.380 [111.25]	3.900 [99.06]	5-102802-5	5-102589-1	6-534245-0
90	4.880 [123.95]	4.400 [111.76]	6-102802-0	6-102589-4	—
100	5.380 [136.65]	4.900 [124.46]	5-102802-6	5-102589-3	6-534245-1
120	6.380 [162.05]	5.900 [149.86]	5-102802-2	6-102589-1	5-534245-3
130	6.880 [174.75]	6.400 [162.56]	6-102802-9	6-102589-9	6-534245-3

**Note:** Headers with make first/break last posts can be made available, consult TE.

**Note:** All part numbers are RoHS compliant.



## Headers, Straight Post, Triple-Row, .100 x .100 [2.54 x 2.54] Centerline

### Solder Posts (with Pin Protection and Guide Pins)



#### Material and Finish

**Housing** — Glass-filled thermoplastic, black, 94V-0 rated

**Posts** — Phosphor bronze, plated as follows:

**Plating A** — Duplex plated .000030 [0.00076] gold on contact area, .000100-.000200 [0.00254-0.00508] matte tin on termination end, with entire post underplated .000050 [0.00127] nickel

#### Related Product Data

**Mateable Receptacles** — page 197

**Performance Specifications** — page 194

**Technical Documents** — page 276

**Product Specification**  
108-25017

**Application Specification**  
114-9009

**Additional header assembly sizes are available; minimum order quantities may apply. Consult TE.**

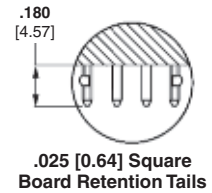
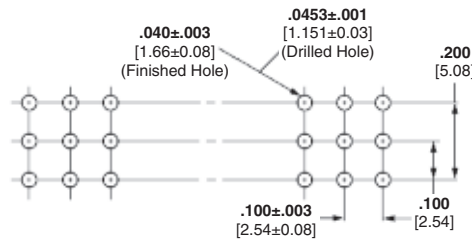
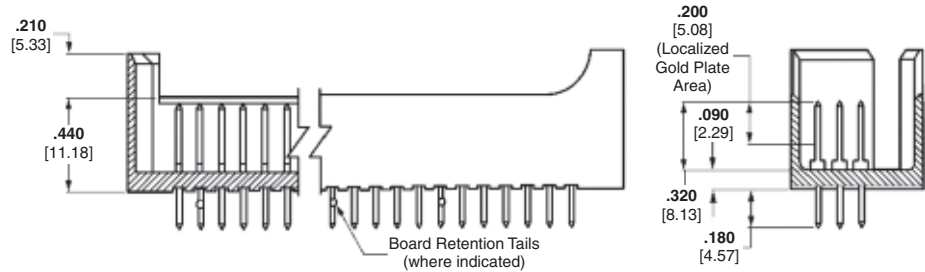
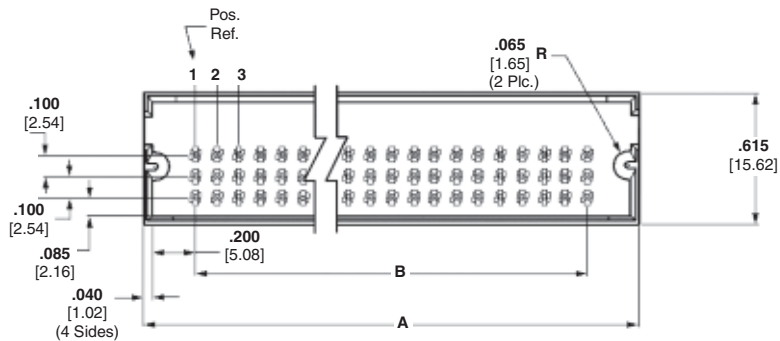

#### Recommended PC Board Hole Layout (for .055 [1.40] min. thick PC board)

Tolerances not to accumulate within one connector pattern.

No. of Pos.	Dimensions		Header Part Nos. with .180 [4.57] Tail Length	
	A	B	Standard Solder Tails Plating A	Board Retention Tails Plating A
72	2.780 [70.61]	2.300 [58.42]	5-103264-1	5-534258-1
96	3.480 [88.39]	3.000 [76.20]	—	5-534258-3
150	5.380 [136.65]	4.900 [124.46]	5-103264-3	—
210	7.380 [187.45]	6.900 [175.26]	5-103264-4	—

**Note:** All part numbers are RoHS compliant.

## Headers, VRM (Voltage Regulator Module), .100 x .100 [2.54 x 2.54] Centerline

### Solder Posts and ACTION PIN Posts (with Pin Protection, Guide Ribs, and Latching)

#### Material and Finish

**Housing** — Glass-filled thermoplastic, black, 94V-0 rated

**Posts** — Copper alloy, duplex plated .000030 [0.00076] gold on contact area, .000100-.000200 [0.00254-0.00508] matte tin on termination end, with entire post underplated .000050 [0.00127] nickel

#### Related Product Data

**Mateable Receptacles** — pages 195, 196

**Performance Specifications** — page 194

**ACTION PIN Posts** — page 150, 151

**Application Tooling** — pages 152

**Technical Documents** — page 276

**Product Specification**  
108-25017

**Application Specification**  
114-9009

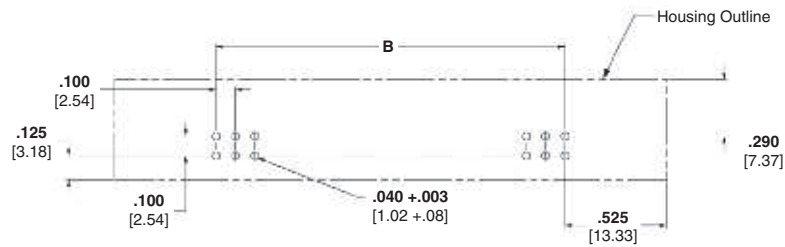
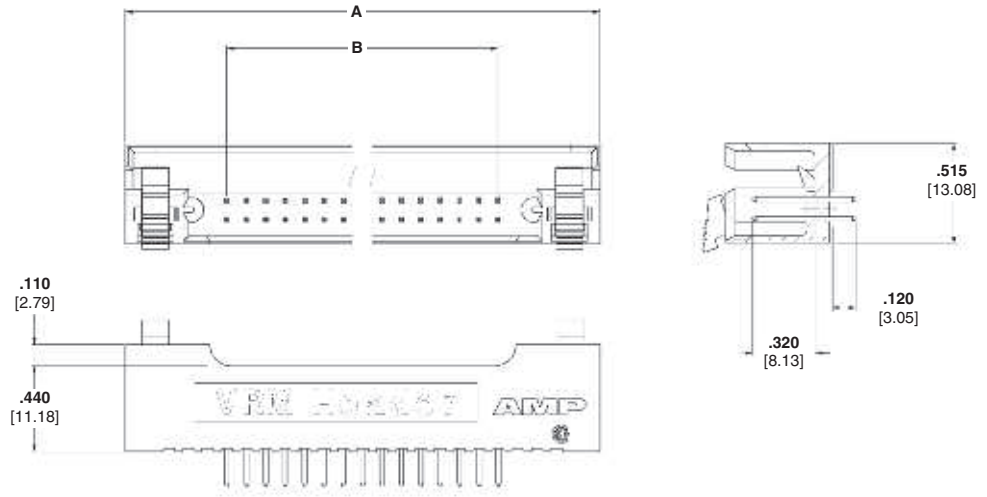

Recommended PC Board Hole Layout

No of Pos	Dimensions		Header Part No.	
	A	B	Standard Solder Tails	.250 Length ACTION PIN Tails
30	2.450 [62.23]	1.400 [35.56]	5-146205-1	—
40	3.095 [78.62]	1.900 [48.26]	—	5-147254-1
	3.100 [78.74]	1.900 [48.26]	5-146315-1	—

**Note:** All part numbers are RoHS compliant.

## Accessories: End Shrouds for Machine-Applied Posts

### Single-Row, .100 [2.54] Centers Part No. 102338-1

**Material** — Black thermoplastic, flame retardant

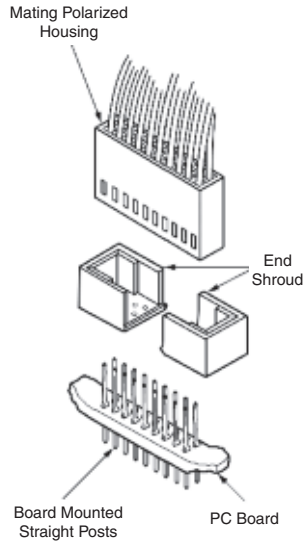

Typical Assembly

Technical Documents — page 276

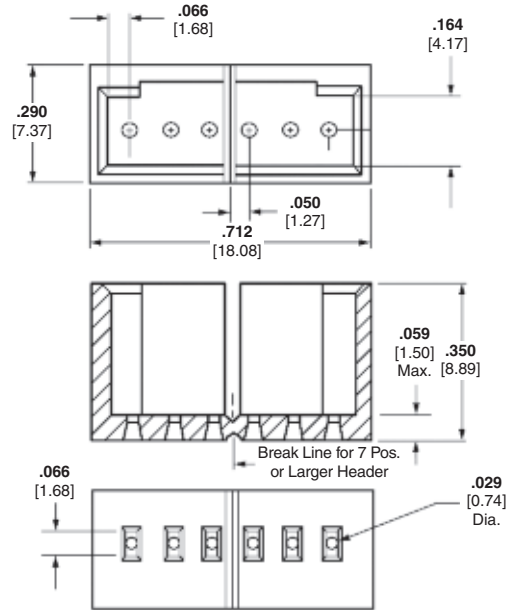

### Double-Row, .100 x .100 [2.54 x 2.54] Centers Part No. 102114-1

**Material** — Black glass-filled polyester

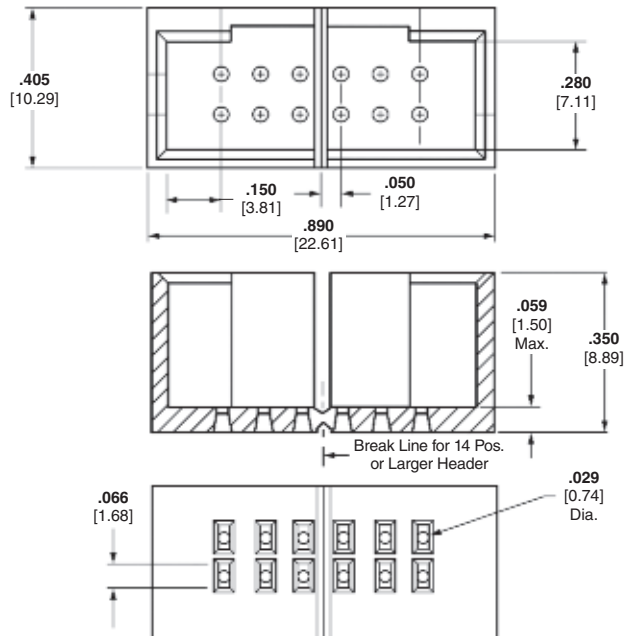

**Note:** All part numbers are RoHS compliant.

## Accessories: Barrier Insert, Part No. 87743-1

### Material

Black polyester

### Technical Documents — page 276

The barrier insert can be used on double row headers (.100 x .100 [2.54 x 2.54] centers), including shrouded versions—3 and 4 sides, as well as unshrouded straight post headers. With one barrier insert several configurations can be obtained, providing headers with capabilities of accepting various combinations of polarized and non-polarized AMPMODU connectors.

For unshrouded headers, the barrier insert is used to establish polarization and to compartmentalize the header. For shrouded headers, the barrier insert is used to compartmentalize the header, while maintaining polarization. The barrier insert itself is notched to facilitate cutting off the ends with a simple tool such as tin snips or scissors to achieve the desired configuration.

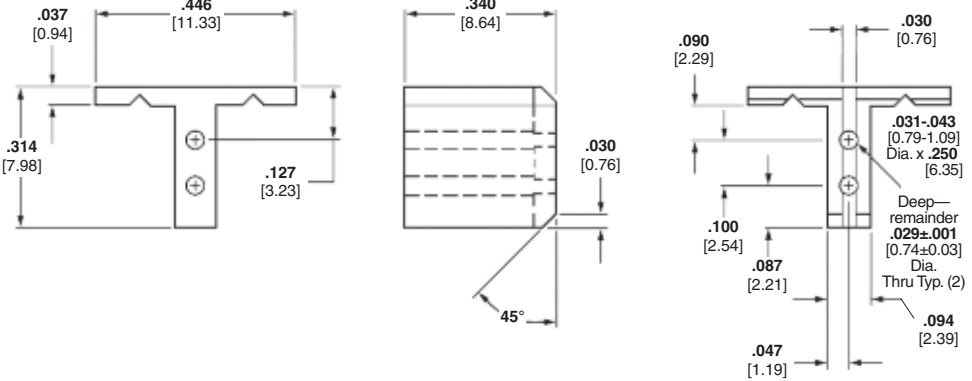

### Barrier Insert Cutoffs

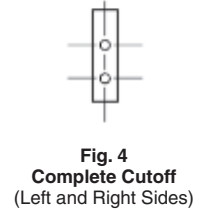
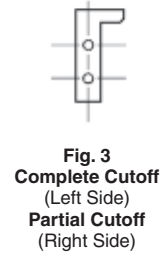
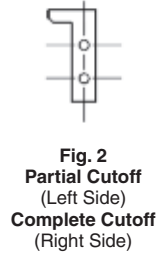
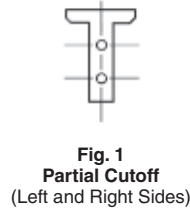

### Typical Barrier Insert Applications

#### For Unshrouded Double-Row, Straight Post Headers, .100 x .100 [2.54 x 2.54] Centers

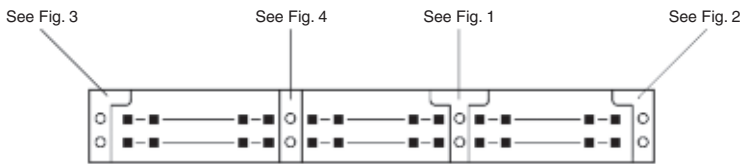

**Note:** All configurations of barrier inserts compartmentalize headers and maintain polarization, except bar (Fig. 4) configuration, which is used primarily for compartmentalizing headers.

#### For Shrouded Double-Row, 3 and 4 Sided Headers, .100 x .100 [2.54 x 2.54] Centers

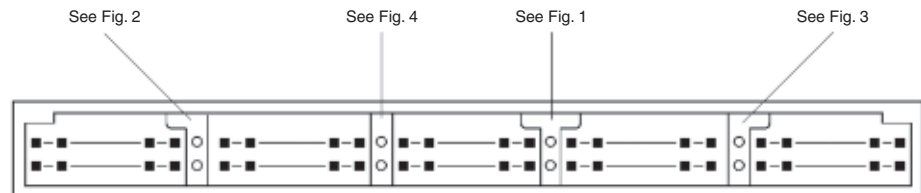

**Note:** Right-angle (Figs. 2 and 3) and “T” (Fig. 1) configurations of barrier insert establish polarization; bar (Fig. 4) configuration of barrier insert compartmentalizes header.

**Note:** All part numbers are RoHS compliant.

## Accessories: Snap-In Polarizer for Low Profile Headers

### Material

Black thermoplastic, flame retardant

### Part Numbers

499991-2 (Packaged 50 per bag)

499991-3 (Packaged 1000 per bag)

### Related Product Data

Low Profile Headers used with —  
pages 135-140

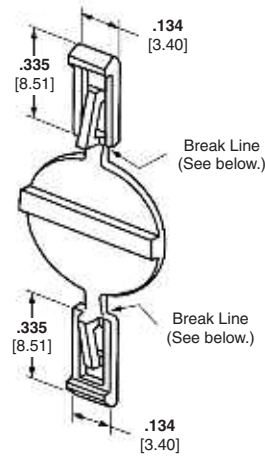

The snap-in polarizer provides military polarization for low profile headers. Installation of the polarizer is as follows:



Orient the polarizer so that the polarizer latch is on the same side as the inner wall (post side) of the header housing.

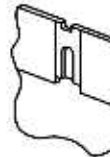

Slide the polarizer over the polarizing slot of the housing until the latch engages the hole. Snap off the tab at the break line next to the housing. Using the remaining polarizer, repeat the process for the other housing location.

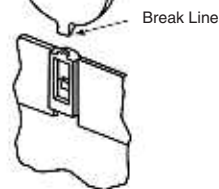



**Note:** For Post Shunts, contact TE.

**Note:** All part numbers are RoHS compliant.

## Locking Clip Contacts and Housings

### Product Facts

- Self-retaining contacts provide permanent connection with quick connect and disconnect
- Fast, easy installation with no additional locking hardware required
- Mates with .025 [0.64] square posts in a variety of configurations
- Single- and double-row configurations in up to 20 positions on .100 [2.54] centers
- Modular design permits end-to-end stacking (double- row only) for circuit grouping
- Choice of tin or select gold plating
- Housings made of 94V-0 rated glass-filled polyester
- Recognized under the Component Program of Underwriters Laboratories Inc., File No. E28476 
- Certified by Canadian Standards Association, File No. LR 7189 

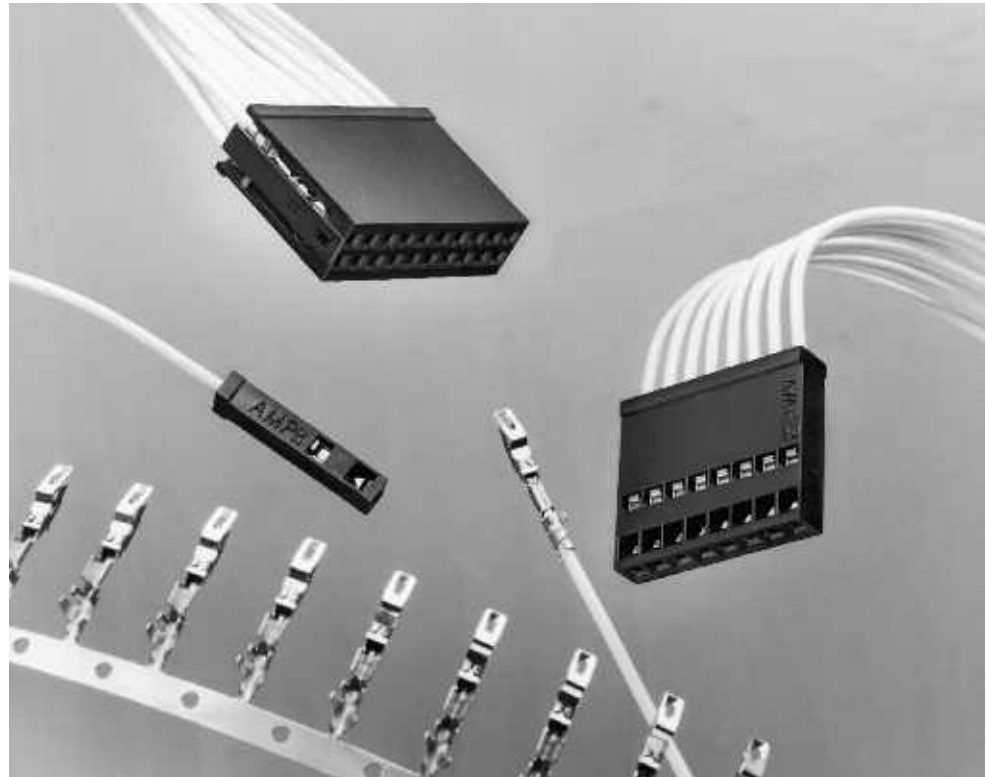

### Typical Application

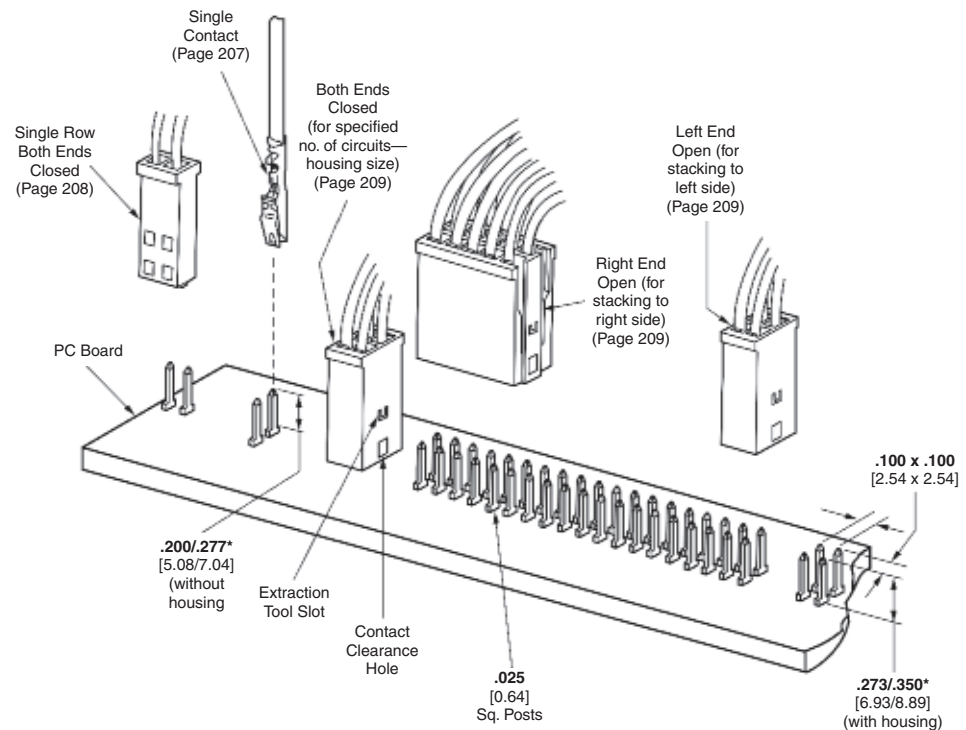

\*If post is longer than maximum specified, post tip may butt against wire ends.  
Dimension defines .025 x .025 [0.64 x 0.64] portion of post.

### Performance Characteristics

**Contact Current Rating** — 3 amperes

**Termination Resistance** —  
12 milliohms (max.) — Gold plated contacts  
16 milliohms (max.) — Tin plated contacts

**Durability** — Ref. Product Specification 108-36028 and 108-36028-1

## Locking Clip Contacts

### Wire Crimp Contacts with Insulation Support

#### Material and Finish

**Contact Spring** — Stainless steel

**Plating A** — Selectively plated .000050 [0.00127] gold on contact area, with gold flash over .000050 [0.00127] nickel on entire contact

**Plating B** — Selectively plated .000030 [0.00076] gold on contact area, with gold flash over .000050 [0.00127] nickel on entire contact

**Plating C** — .000100-.000200 [0.00254-0.00508] bright tin over .000050 [0.00127] nickel on entire contact

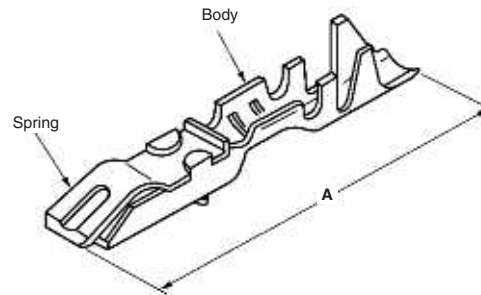

Wire Size Range		Ins. Dia. Range	Dimension A	Finish	Part Nos.		Heavy Duty Miniature Applicator for AMP-O-LECTRIC Machine*	Hand Tool No.
AWG	[mm <sup>2</sup> ]				Strip Form	Loose Piece		
30-28	0.05-0.09	.029-.039 [0.74-0.99]	.550 [13.97]	Plating B	87190-1	87191-1	567310-2	90295-1
				Plating C	5-87190-2	5-87191-2		
26-22	0.12-0.4	.038-.062 [0.97-1.57]	.584 [14.83]	Plating A	87124-3	87165-3	466721-2	91533-1
				Plating B	87124-1	87165-1		
				Plating C	5-87124-2	5-87165-2		
20	0.5-0.6	.038-.062 [0.97-1.57]	.584 [14.83]	Plating B	867052-2	—	679996-2	90431-1
				Plating C	5-867052-1	—		

\*For use with AMP-O-LECTRIC Model "K" machines. Call the Technical Support Center (1-800-522-6752) for part nos. of applicators for use with the AMP-O-LECTRIC Model "G" machines (shown on page 270), as well as other bench machines and fully automatic AMPOMATOR lead making machines.

- Notes:** 1. These contacts must be crimped in accordance with TE Specification No. 114-25006 in order to function properly in a connector housing.  
2. **Extraction Tool No. 91084-1** is used for removing individual contacts from connector housings and for detaching contacts from mating posts.

#### Related Product Data

**Housings Used With** — pages 208, 209

**Application Tooling** — page 272

**Technical Documents** — pages 277, 278

**Product Specification** 108-36028, 108-36028-1

**Application Specification** 114-25006

#### Wire Harnessing

If necessary, wires can be grouped with cable ties and secured to a panel with fixed clamps. However, locking clip contacts must be free to float within the connector housings to allow proper extraction. Therefore, harnessing hardware or the use of multiple terminations per contact must not restrict the free-floating action of contacts in the housing.

For more information request Insulation and Bundling Products Catalog 124132.

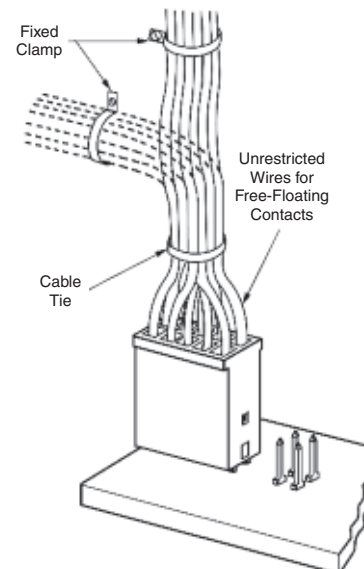

**Extraction Tool No. 91084-1**

**Note:** All part numbers are RoHS compliant.

## Wire-Applied Housings for Locking Clip Contacts, Single-Row, .100 [2.54] Centerline

### Single-Row



#### Material

Glass-filled polyester, 94V-0 rated

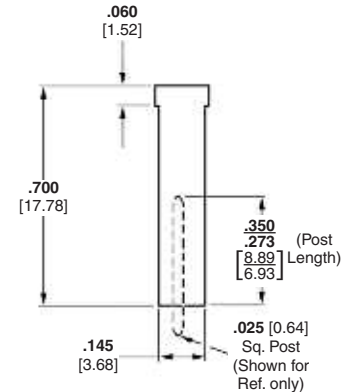
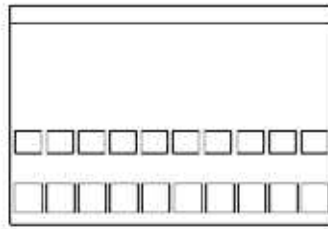

#### Related Product Data

**Contacts** — page 207

**Mateable Headers and Posts** — Refer to the Mating Post Selection Guide — page 90

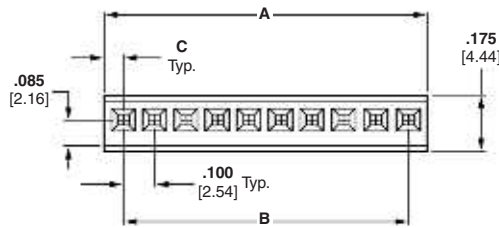

**Note:** Housing illustrated above is the "Both Ends Closed" version.

**Technical Documents** — pages 277, 278

**Product Specification**  
108-36028, 108-36028-1

**Application Specification**  
114-25006

**.125 [3.18] centerline single-row, 2 and 3 position housings are available, Base Part No. 104905. They are designed to be stackable end-to-end and side-by-side. Consult TE.**

### Keying Plug



**Part No. 87179-1**

(Plugs directly into housings for .025 [0.64] square post contacts)

**Material** — Yellow, nylon

**Note:** All part numbers are RoHS compliant.

No. of Pos.	Dimensions			Housing Part No.	
	A	B	C	Unstamped	Stamped
1	.108 [2.74]	—	.054 [1.37]	87175-2	—
2	.216 [5.49]	.100 [2.54]	.058 [1.47]	87175-6	—
3	.316 [8.03]	.200 [5.08]	.058 [1.47]	87175-8	—
4	.416 [10.57]	.300 [7.62]	.058 [1.47]	1-87175-0	—
5	.516 [13.11]	.400 [10.16]	.058 [1.47]	1-87175-2	—
6	.616 [15.65]	.500 [12.70]	.058 [1.47]	1-87175-4	1-87175-3
7	.716 [18.19]	.600 [15.24]	.058 [1.47]	1-87175-6	1-87175-5
8	.816 [20.73]	.700 [17.78]	.058 [1.47]	1-87175-8	1-87175-7
9	.916 [23.27]	.800 [20.32]	.058 [1.47]	2-87175-0	1-87175-9
10	1.016 [25.81]	.900 [22.86]	.058 [1.47]	2-87175-2	2-87175-1
11	1.116 [28.35]	1.000 [25.40]	.058 [1.47]	2-87175-4	2-87175-3
12	1.216 [30.89]	1.100 [27.94]	.058 [1.47]	2-87175-6	2-87175-5
13	1.316 [33.43]	1.200 [30.48]	.058 [1.47]	2-87175-8	2-87175-7
14	1.416 [35.97]	1.300 [33.02]	.058 [1.47]	3-87175-0	2-87175-9
15	1.516 [38.51]	1.400 [35.56]	.058 [1.47]	87175-4	87175-3



## Wire-Applied Housings for Locking Clip Contacts, Double-Row, .100 x .100 [2.54 x 2.54] Centerline

### Double-Row



#### Material

Glass-filled polyester, 94V-0 rated

#### Related Product Data

**Contacts** — page 207

**Mateable Headers and Posts** — Refer to the Mating Post Selection Guide — page 90

**Technical Documents** — pages 277, 278

**Product Specification**  
108-36028, 108-36028-1

**Application Specification**  
114-25006

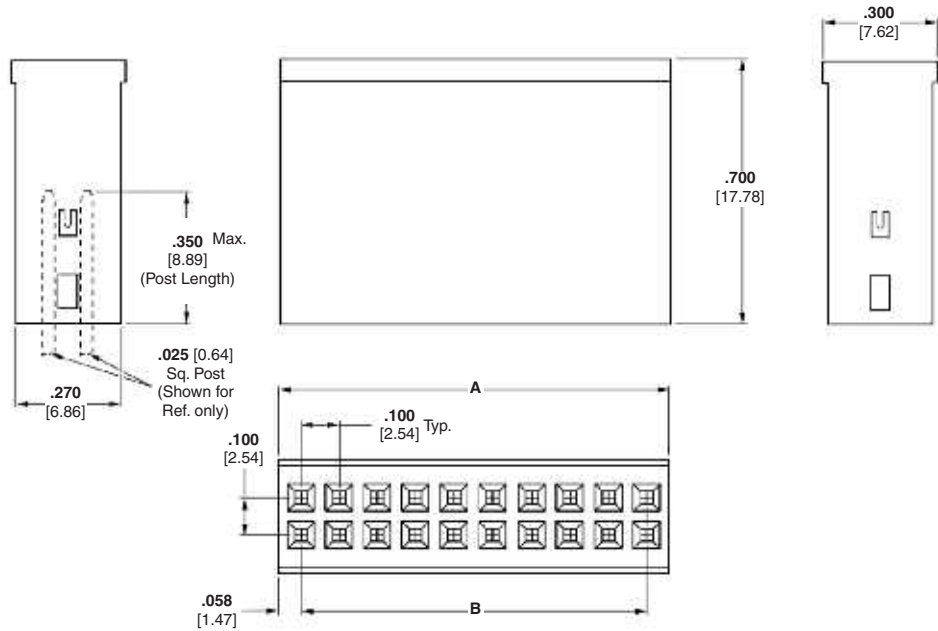

**Note:** Housing illustrated above is the "Both Ends Closed" version.



Both Ends Closed

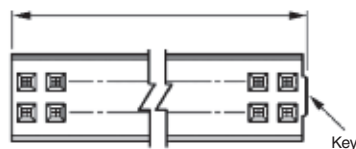

Right End Open



Left End Open

### Keying Plug



**Part No. 87179-1**

(Plugs directly into housings for .025 [0.64] square post contacts)

**Material** — Yellow, nylon

**Note:** All part numbers are RoHS compliant.

Housing Configuration	No. of Pos.	Dimensions		Housing Part No.	
		A	B	Unstamped	Stamped
Both Ends Closed	2	.116 [2.95]	—	87176-2	—
	4	.216 [5.49]	.100 [2.54]	87133-1	—
	6	.316 [8.03]	.200 [5.08]	87133-7	87133-8
	8	.416 [10.57]	.300 [7.62]	87133-9	1-87133-0
	10	.516 [13.11]	.400 [10.16]	87133-2	87133-5
	12	.616 [15.65]	.500 [12.70]	1-87133-1	1-87133-2
	16	.816 [20.73]	.700 [17.78]	1-87133-3	1-87133-4
	18	.916 [23.27]	.800 [20.32]	1-87133-5	1-87133-6
	20	1.016 [25.81]	.900 [22.86]	87133-3	87133-6
	Right End Open	4	.216 [5.49]	.100 [2.54]	87132-1
10		.516 [13.11]	.400 [10.16]	87132-2	87132-5
20		1.016 [25.81]	.900 [22.86]	87132-3	87132-6
Left End Open	4	.216 [5.49]	.100 [2.54]	87131-1	—
	10	.516 [13.11]	.400 [10.16]	87131-2	87131-5
	20	1.016 [25.81]	.900 [22.86]	87131-3	87131-6

## Mod IV Wire-Applied Contacts and Housings

### Product Facts

- Terminates 32-20 AWG [0.03-0.6mm<sup>2</sup>] discrete wire
- Contacts have insulation support
- Choice of three contact mating pressures
- Available in a variety of gold and tin platings
- Receptacles mate with .025 [0.64] square or round posts
- Dual cantilever contact beam with built-in anti-overstress feature for reliable matings
- Housings accept a variety of receptacle and pin contacts
- Housing sizes range up to 100 positions
- Housing configurations include single- and double-rows on .100 [2.54] centerlines
- Housing options include detent latching, polarization and bonded strain relief/pull tabs
- Recognized under the Component Program of Underwriters Laboratories Inc., File No. E28476
- Certified by Canadian Standards Association, File No. LR 7189

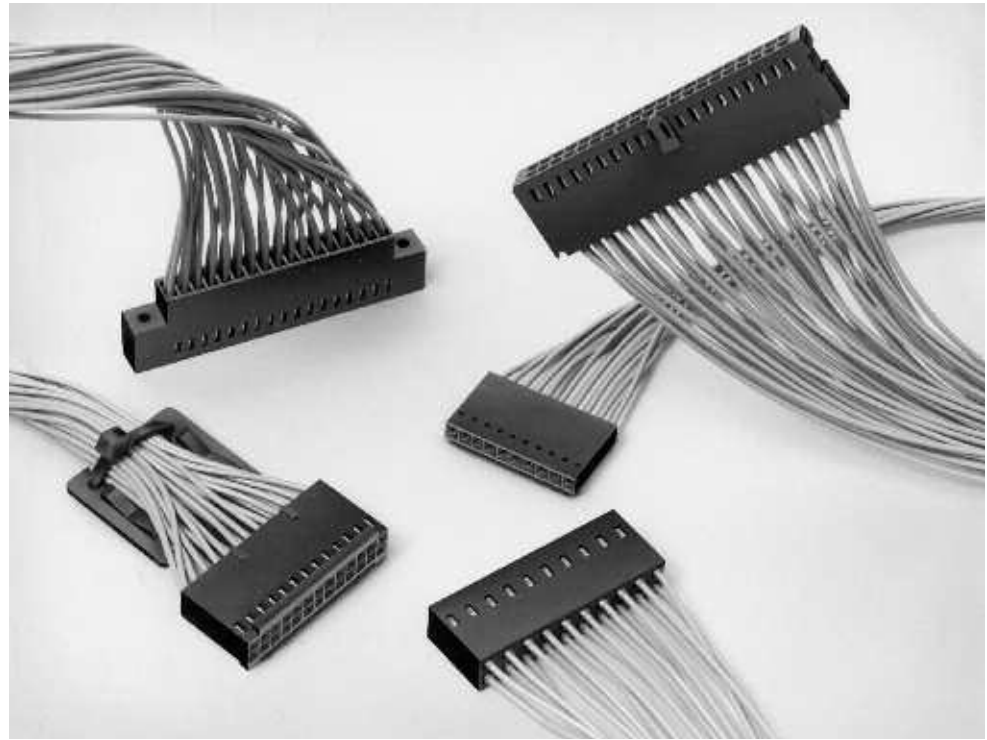

Mod IV Wire-Applied Contacts and Housings

5

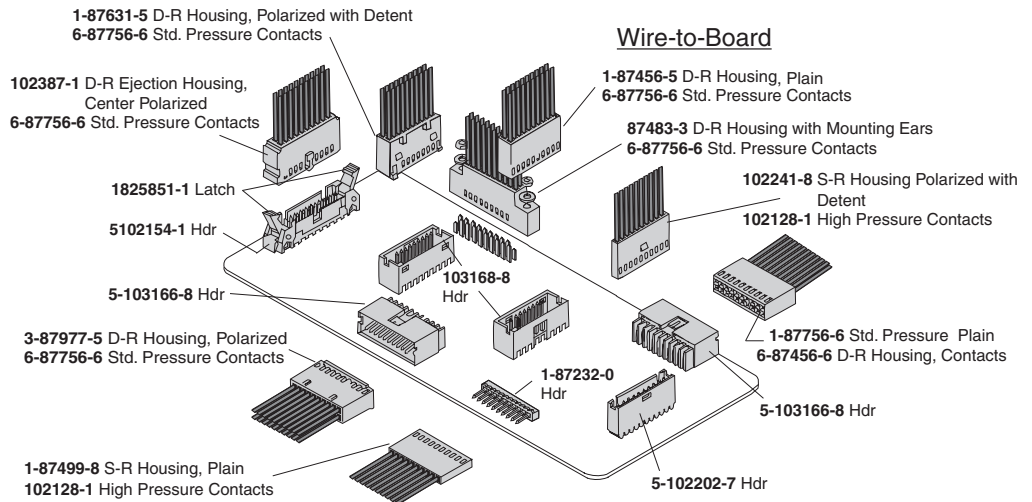

### Performance Characteristics

- Contact Current Rating** — 3 amperes
- Termination Resistance** — 12 milliohms (max.) — Beryllium copper contacts  
20 milliohms (max.) — Copper-tin-phosphor bronze contacts
- Durability** — Ref. Product Specification 108-25020

**Note:** All part numbers are RoHS compliant.

## Mod IV Pin and Receptacle Contacts

### Crimp Snap-In (No-strip) Receptacles and Crimp Snap-In Pins with Insulation Support (Standard Pressure)

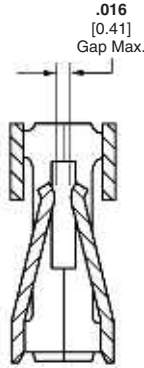

Standard Pressure Configuration

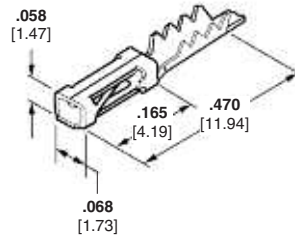

No-Strip Receptacle

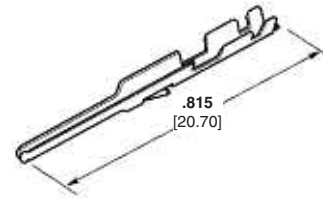

Pin with Insulation Support

### Crimp Snap-In (No-strip) Receptacles

Ins. Dia. Range	Finish	Part Nos.		Heavy Duty Miniature Applicator No. for AMP-O-LECTRIC Machine*	Hand Tool Part No.
		Strip Form	Loose Piece		
.040-.055 [1.02-1.40]	Plating A	87107-5	102348-2	567307-2	90381-1
	Plating C	87107-6	102348-3		

### Material and Finish

Beryllium copper, phosphor bronze, or copper-tin-phosphor bronze (see charts), plated as follows:

**Plating A** — Selectively plated .000030 [0.00076] gold on contact area, with gold flash over .000050 [0.00127] nickel on entire contact

**Plating B** — Selectively plated .000015 [0.00038] gold on contact area, with gold flash over .000050 [0.00127] nickel on entire contact

**Plating C** — .000100-.000200 [0.00254-0.00508] tin over .000030 [0.00076] nickel on entire contact

### Related Product Data

**Housings Used With** — pages 214-220

**Performance Characteristics** — page 210

**Application Tooling** — page 270-272

**Technical Documents** — pages 276-278

**Product Specification** 108-25007, 108-25019, 108-25020, 108-25021

**Application Specification** 114-25003, 114-25016

Additional header sizes are available; minimum order quantities may apply. Consult TE.

### Crimp Snap-In Pins with Insulation Support

Wire Size Range	Ins. Dia. (Max.)	Finish	Part Nos.		Heavy Duty Miniature Applicator No. for AMP-O-LECTRIC Machine*	Hand Tool Part No.	
			Strip Form	Loose Piece		Premium	Commercial
26-22 0.12-0.4	.061 [1.55]	Plating A	102095-3	102107-2	466812-2	91517-1	58641-1†
		Plating B	102095-2	102107-1			
		Plating C	5-102095-4	5-102107-3			

\*For use with AMP-O-LECTRIC Model "K" machines. Call the Technical Support Center (1-800-522-6752) for part nos. of applicators for use with the AMP-O-LECTRIC Model "G" machines (shown on page 270), as well as other bench machines and fully automatic AMPOMATOR lead making machines.

†PRO-CRIMPER II hand tool frame with die set assembly. Die Set Part No. 58641-2

**Note:** All part numbers are RoHS compliant.

## Mod IV Receptacle Contacts

### Crimp Snap-In Receptacles with Insulation Support (Standard, Intermediate and High Pressure)

#### Material and Finish

Beryllium copper, phosphor bronze or copper-tin-phosphor bronze (see charts, on following page), plated as follows:

**Plating A** — Duplex plated .000030 [0.00076] gold on contact area, .000100-.000200 [0.00254-0.00508] tin on crimp area, with entire contact underplated .000050 [0.00127] nickel

**Plating B** — Duplex plated .000015 [0.00038] gold on contact area, .000100-.000200 [0.00254-0.00508] tin on crimp area, with entire contact underplated .000050 [0.00127] nickel

**Plating D** — Selectively plated .000050 [0.00127] gold on contact area, with gold flash over .000050 [0.00127] nickel on entire contact

**Plating E** — Selectively plated .000030 [0.00076] gold on contact area, with gold flash over .000050 [0.00127] nickel on entire contact

**Plating F** — Selectively plated .000015 [0.00038] gold on contact area, with gold flash over .000050 [0.00127] nickel on entire contact

**Plating G** — .000100-.000200 [0.00254-0.00508] tin over .000030 [0.00076] nickel on entire contact

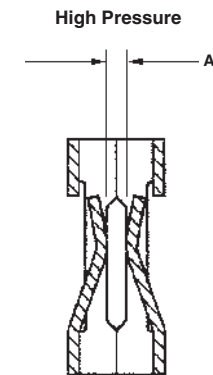
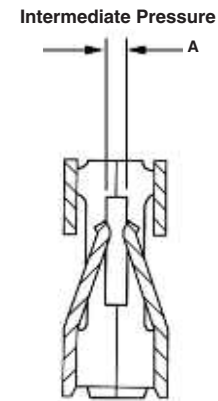
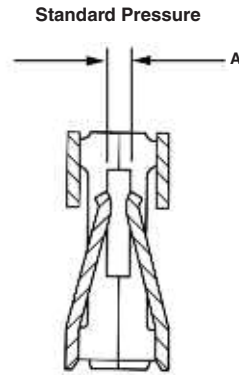
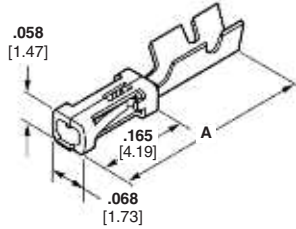

#### Related Product Data

**Housings Used With** — pages 214-220

**Performance Characteristics** — page 210

**Application Tooling** — pages 270-272

**Technical Documents** — pages 277, 278

**Product Specification**  
108-25007, 108-25019, 108-25020, 108-25021

**Application Specification**  
114-25003, 114-25016

	Mating Force	Unmating Force	A-Gap Dimension
Standard Pressure	9 oz. Max.	1.5 oz. Min.	.008/.014
Intermediate Pressure	16 oz. Max.	2 oz. Min.	.008/.014
High Pressure	20 oz. Max.	3 oz. Min.	.013±.002

**Mod IV Receptacle Contacts** (Continued)

**Standard Pressure (Mod IV)**

Wire Size Range AWG [mm <sup>2</sup> ]	Ins. Dia. (Max.)	Dimension A	Material	Finish	Part Nos.		Heavy Duty Miniature Applicator for AMP-O-LECTRIC Machine*	Applicator for Stripper/Crimper Machine	Hand Tool Part Nos.	
					Strip Form	Loose Piece			Premium	Commercial
32-27 0.03-0.1	.040 [1.02]	.445 [11.30]	Cu-Sn-Ph Bz	Plating A	5-102316-8	6-102316-4	466655-2	466921-1	91541-1	—
			Cu-Sn-Ph Bz	Plating B	5-102316-6	6-102316-3				
			Be Cu	Plating D	1-102917-1	1-102917-2				
			Be Cu	Plating E	102917-1	102917-2				
			Be Cu	Plating F	102917-5	102917-6				
26-22 0.12-0.4	.061 [1.55]	.445 [11.30]	Cu-Sn-Ph Bz	Plating G	102316-5	1-102316-2	466571-2	466918-1	91517-1	58641-1†
			Cu-Sn-Ph Bz	Plating A	6-87756-7	6-87756-8				
			Cu-Sn-Ph Bz	Plating B	6-87756-2	6-87756-6				
			Cu-Sn-Ph Br	Plating G	87756-6	87756-7				
			Be Cu	Plating D	1-87666-6	87667-5				
			Be Cu	Plating E	87666-2	87667-2				
			Be Cu	Plating F	87666-5	87667-5				
24-20 0.2-0.6	.069 [1.75]	.470 [11.94]	Cu-Sn-Ph Bz	Plating G	87666-3	87667-3	466562-2	466905-1	91516-1	—
			Cu-Sn-Ph Bz	Plating A	6-87523-8	6-87523-9				
			Cu-Sn-Ph Bz	Plating B	2-87523-3	2-87523-4				
			Be Cu	Plating E	85969-8	86016-2				
			Be Cu	Plating F	85969-6	86016-5				
			Cu-Sn-Ph Br	Plating G	87523-5	87523-6				
			Be Cu	Plating G	85969-9	86016-3				

**Intermediate Pressure (Mod IV.v)**

Wire Size Range AWG [mm <sup>2</sup> ]	Ins. Dia. (Max.)	Dimension A	Material	Finish	Part Nos.		Heavy Duty Miniature Applicator for AMP-O-LECTRIC Machine*	Applicator for Stripper/Crimper Machine	Hand Tool Part Nos.	
					Strip Form	Loose Piece			Premium	Commercial
32-27 0.03-0.1	.040 [1.02]	.445 [11.30]	Cu-Sn-Ph Bz	Plating A	5-102920-1	5-102920-2	466655-2	466921-1	91541-1	—
			Be Cu	Plating E	102918-1	102918-2				
26-22 0.12-0.4	.061 [1.55]	.445 [11.30]	Cu-Sn-Ph Bz	Plating A	5-103171-4	5-103171-5	466571-2	466918-1	91517-1	58641-1†
			Cu-Sn-Ph Bz	Plating B	5-103171-1	5-103171-2				
			Be Cu	Plating E	102548-5	102548-6				
			Be Cu	Plating F	102548-1	102548-3				
24-20 0.2-0.6	.069 [1.75]	.470 [11.94]	Cu-Sn-Ph Bz	Plating A	2-87195-3	2-87195-6	466562-2	466905-1	91516-1	—
			Cu-Sn-Ph Bz	Plating B	2-87195-4	2-87195-5				
			Be Cu	Plating E	86492-6	87046-3				
			Be Cu	Plating F	86492-2	87046-1				
			Be Cu	Plating G	86492-9	87046-4				

**High Pressure (Mod V)\*\***

Wire Size Range AWG [mm <sup>2</sup> ]	Ins. Dia. (Max.)	Dimension A	Material	Finish	Part Nos.		Heavy Duty Miniature Applicator for AMP-O-LECTRIC Machine*	Applicator for AMP-O-MATIC Stripper/Crimper Machine	Hand Tool Part Nos.
					Strip Form	Loose Piece			
32-27 0.03-0.1	.040 [1.02]	.445 [11.30]	Ph Bz	Plating E	103455-1	103455-2	466655-2	466921-1	91541-1
26-22 0.12-0.4	.061 [1.55]	.445 [11.30]	Ph Bz	Plating E	87809-1	102128-1	466571-2	466918-1	91517-1
			Ph Bz	Plating G	87809-2	102128-2			
24-20 0.2-0.6	.069 [1.75]	.470 [11.94]	Ph Bz	Plating E	87309-9	1-87309-4	466562-2	466905-1	91516-1
			Ph Bz	Plating G	87309-8	1-87309-3			

\*For use with AMP-O-LECTRIC Model "K" machines. Call the Technical Support Center (1-800-522-6752) for part nos. of applicators for use with the AMP-O-LECTRIC Model "G" machines (shown on page 270), as well as other bench machines and fully automatic AMPOMATOR lead making machines.

\*\*Contact material is phosphor bronze.

†PRO-CRIMPER II hand tool frame with die set assembly. Die Set Part No. 58641-2

**Note:** All part numbers are RoHS compliant.

## Mod IV Wire-Applied Housings, Single-Row, .100 [2.54] Centerline

### Non-Polarized



### Material

Black thermoplastic, flame retardant

### Related Product Data

**Contacts** — pages 211-213

**Mateable Headers and Posts** — pages 93-95, 101-103

### Technical Documents —

pages 277, 278

### Product Specification

108-25007, 108-25019, 108-25020, 108-25021

### Application Specification

114-25003, 114-25016

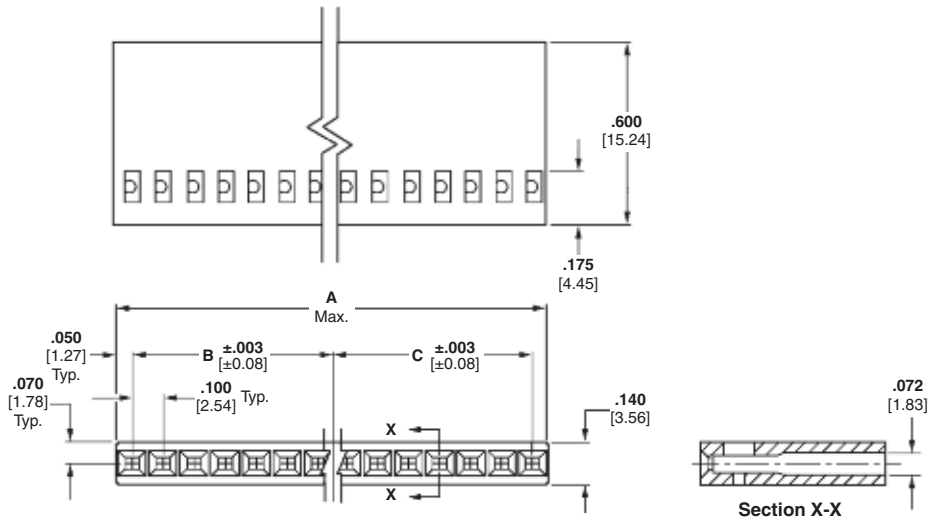

No. of Pos.	Dimensions			Part No.	
	A	B	C	Stamped*	Unstamped**
1	.105 [2.67]	—	—	—	7-87499-2
2	.205 [5.21]	.100 [2.54]	—	87499-3	87499-4
3	.305 [7.75]	.100 [2.54]	.100 [2.54]	87499-5	87499-6
4	.405 [10.29]	.200 [5.08]	.100 [2.54]	87499-7	87499-8
5	.505 [12.83]	.200 [5.08]	.200 [5.08]	87499-9	1-87499-0
6	.605 [15.37]	.300 [7.62]	.200 [5.08]	1-87499-1	1-87499-2
7	.705 [17.91]	.300 [7.62]	.300 [7.62]	87499-1	87499-2
8	.805 [20.45]	.400 [10.16]	.300 [7.62]	1-87499-3	1-87499-4
9	.905 [22.99]	.400 [10.16]	.400 [10.16]	1-87499-5	1-87499-6
10	1.005 [25.53]	.500 [12.70]	.400 [10.16]	1-87499-7	1-87499-8
11	1.105 [28.01]	.500 [12.70]	.500 [12.70]	1-87499-9	2-87499-0
12	1.205 [30.61]	.600 [15.24]	.500 [12.70]	2-87499-1	2-87499-2
13	1.305 [33.15]	.600 [15.24]	.600 [15.24]	2-87499-3	2-87499-4
14	1.405 [35.69]	.700 [17.78]	.600 [15.24]	2-87499-5	2-87499-6
15	1.505 [38.23]	.700 [17.78]	.700 [17.78]	2-87499-7	2-87499-8
16	1.605 [40.77]	.800 [20.32]	.700 [17.78]	2-87499-9	3-87499-0
17	1.700 [43.18]	.800 [20.32]	.800 [20.32]	—	3-87499-2
18	1.805 [45.85]	.900 [22.86]	.800 [20.32]	—	3-87499-4
19	1.900 [48.26]	.900 [22.86]	.900 [22.86]	—	3-87499-6
20	2.005 [50.93]	1.000 [25.40]	.900 [22.86]	3-87499-7	3-87499-8
21	2.100 [53.34]	1.000 [25.40]	1.000 [25.40]	—	4-87499-0
22	2.205 [56.01]	1.100 [27.94]	1.000 [25.40]	—	4-87499-2
23	2.300 [58.42]	1.100 [27.94]	1.100 [27.94]	—	4-87499-4
24	2.400 [60.96]	1.200 [30.48]	1.100 [27.94]	—	4-87499-6
25	2.500 [63.50]	1.200 [30.48]	1.200 [30.48]	—	4-87499-8
26	2.605 [66.17]	1.300 [33.02]	1.200 [30.48]	—	5-87499-0
27	2.700 [68.58]	1.300 [33.02]	1.300 [33.02]	—	5-87499-2
28	2.800 [71.12]	1.400 [35.56]	1.300 [33.02]	—	5-87499-4
29	2.900 [73.66]	1.400 [35.56]	1.400 [35.56]	—	5-87499-6
30	3.005 [76.33]	1.500 [38.10]	1.400 [35.56]	—	5-87499-8
31	3.100 [78.74]	1.500 [38.10]	1.500 [38.10]	—	6-87499-0
32	3.200 [81.28]	1.600 [40.64]	1.500 [38.10]	—	6-87499-2
33	3.300 [83.82]	1.600 [40.64]	1.600 [40.64]	—	6-87499-4
34	3.400 [86.36]	1.700 [43.18]	1.600 [40.64]	—	6-87499-6
35	3.500 [88.98]	1.700 [43.18]	1.700 [43.18]	—	6-87499-8
36	3.600 [91.44]	1.800 [45.72]	1.700 [43.18]	—	7-87499-0

\*Cavity identification, part number and date code stamped on housing where size permits.

\*\*No marking on housing.

**Notes:** 1. Strain reliefs are available and may be purchased separately. Consult TE.  
2. Contact **Extraction/Lance Reset Tool No. 843996-3**.

**Note:** All part numbers are RoHS compliant.

### Keying Plugs

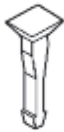

**Part No. 86286-1**

(Plugs into standard or intermediate pressure receptacle contact)

**Material** — Natural color nylon

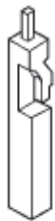

**Part No. 87077-2**

(Plugs directly into housing)

**Mod IV Wire-Applied Housings, Single-Row, .100 [2.54] Centerline** (Continued)

**Polarized (with Detent Latching)**

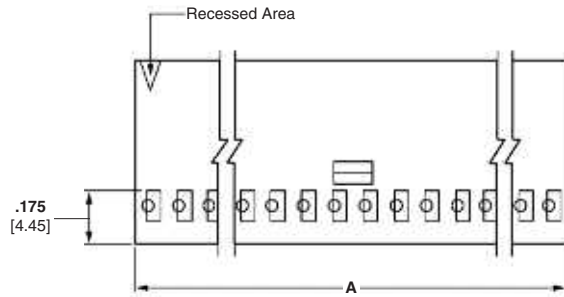

**Material**

Black thermoplastic, flame retardant

**Related Product Data**

- Contacts** — pages 211-213
- Mateable Headers and Posts** — pages 115, 116
- Flexible Film Connectors, Single-Row Pin Assemblies** — Catalog 82007

**Technical Documents** — pages 277, 278

**Product Specification**  
108-25007, 108-25019, 108-25020, 108-25021

**Application Specification**  
114-25003, 114-25016

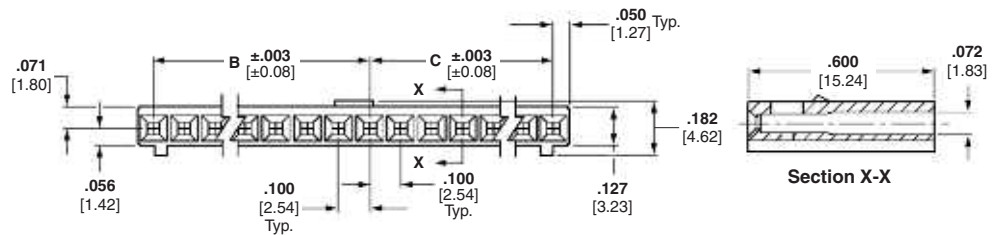

No. of Pos.	Dimensions			Part Nos. Unstamped*
	A	B	C	
3	.300 [7.62]	.100 [2.54]	.100 [2.54]	102241-1
4	.400 [10.16]	.200 [5.08]	.100 [2.54]	102241-2
5	.500 [12.70]	.200 [5.08]	.200 [5.08]	102241-3
6	.600 [15.24]	.300 [7.62]	.200 [5.08]	102241-4
7	.700 [17.78]	.300 [7.62]	.300 [7.62]	102241-5
8	.800 [20.32]	.400 [10.16]	.300 [7.62]	102241-6
9	.900 [22.86]	.400 [10.16]	.400 [10.16]	102241-7
10	1.000 [25.40]	.500 [12.70]	.400 [10.16]	102241-8
11	1.100 [27.94]	.500 [12.70]	.500 [12.70]	102241-9
12	1.200 [30.48]	.600 [15.24]	.500 [12.70]	1-102241-0
13	1.300 [33.02]	.600 [15.24]	.600 [15.24]	1-102241-1
14	1.400 [35.56]	.700 [17.78]	.600 [15.24]	1-102241-2
15	1.500 [38.10]	.700 [17.78]	.700 [17.78]	1-102241-3
16	1.600 [40.64]	.800 [20.32]	.700 [17.78]	1-102241-4
17	1.700 [43.18]	.800 [20.32]	.800 [20.32]	1-102241-5
18	1.800 [45.72]	.900 [22.86]	.800 [20.32]	1-102241-6
19	1.900 [48.26]	.900 [22.86]	.900 [22.86]	1-102241-7
20	2.000 [50.80]	1.000 [25.40]	.900 [22.86]	1-102241-8
21	2.100 [53.34]	1.000 [25.40]	1.000 [25.40]	1-102241-9
22	2.200 [55.88]	1.100 [27.94]	1.000 [25.40]	2-102241-0
23	2.300 [58.42]	1.100 [27.94]	1.100 [27.94]	2-102241-1
24	2.400 [60.96]	1.200 [30.48]	1.100 [27.94]	2-102241-2
25	2.500 [63.50]	1.200 [30.48]	1.200 [30.48]	2-102241-3
26	2.600 [66.04]	1.300 [33.02]	1.200 [30.48]	2-102241-4
27	2.700 [68.58]	1.300 [33.02]	1.300 [33.02]	2-102241-5
28	2.800 [71.12]	1.400 [35.56]	1.300 [33.02]	2-102241-6
29	2.900 [73.66]	1.400 [35.56]	1.400 [35.56]	2-102241-7
30	3.000 [76.20]	1.500 [38.10]	1.400 [35.56]	2-102241-8
31	3.100 [78.74]	1.500 [38.10]	1.500 [38.10]	2-102241-9
32	3.200 [81.28]	1.600 [40.64]	1.500 [38.10]	3-102241-0
33	3.300 [83.82]	1.600 [40.64]	1.600 [40.64]	3-102241-1
34	3.400 [86.36]	1.700 [43.18]	1.600 [40.64]	3-102242-2
35	3.500 [88.90]	1.700 [43.18]	1.700 [43.18]	3-102241-3
36	3.600 [91.44]	1.800 [45.72]	1.700 [43.18]	3-102241-4

**Keying Plugs**

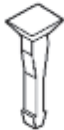

**Part No. 86286-1**  
(Plugs into standard or intermediate pressure receptacle contact)

**Material** — Natural color nylon

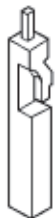

**Part No. 87077-2**  
(Plugs directly into housing)

\*No marking on housing.  
**Note:** Contact Extraction/Lance Reset Tool No. 843996-3.

**Note:** All part numbers are RoHS compliant.

## Mod IV Wire-Applied Housings, Double-Row, .100 x .100 [2.54 x 2.54] Centerline

### Non-Polarized

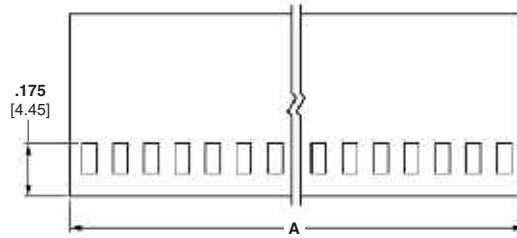

### Material

Black thermoplastic, flame retardant

### Related Product Data

**Contacts** — pages 211-213  
**Mateable Headers and Posts** — pages 96-99, 104, 105, 117-120

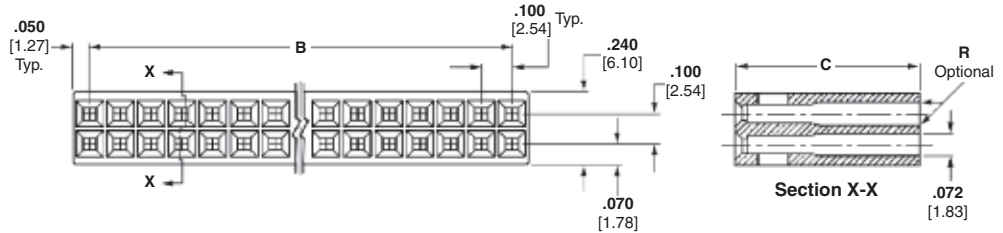

### Technical Documents —

pages 277, 278

**Product Specification**  
 108-25007, 108-25019, 108-25020, 108-25021

**Application Specification**  
 114-25003, 114-25016

### Keying Plugs

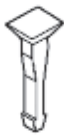

**Part No. 86286-1**  
 (Plugs into standard or intermediate pressure receptacle contact)

**Material** — Natural color nylon

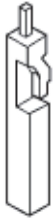

**Part No. 87077-1**  
 (for .645 high housings)  
**Part No. 87077-2**  
 (for .600 high housings)  
 (Plugs directly into housing)

No. of Pos.	Dimensions		Part Nos.		
	A	B	C = .600 [15.24]		C = .645 [16.38]
			Stamped*	Unstamped**	Unstamped**
2	.100 [2.54]	—	—	5-87456-3	—
4	.200 [5.08]	.100 [2.54]	5-87456-0	4-87456-9	2-86177-5
6	.300 [7.62]	.200 [5.08]	87456-2	87456-1	1-86177-8
8	.400 [10.16]	.300 [7.62]	87456-4	87456-3	2-86177-0
10	.500 [12.70]	.400 [10.16]	87456-6	87456-5	1-86177-2
12	.600 [15.24]	.500 [12.70]	87456-8	87456-7	1-86177-3
14	.700 [17.78]	.600 [15.24]	1-87456-0	87456-9	1-86177-4
16	.800 [20.32]	.700 [17.78]	1-87456-2	1-87456-1	1-86177-5
18	.900 [22.86]	.800 [20.32]	1-87456-4	1-87456-3	1-86177-6
20	1.000 [25.40]	.900 [22.86]	1-87456-6	1-87456-5	86177-1
22	1.100 [27.94]	1.000 [25.40]	—	1-87456-7	86177-2
24	1.200 [30.48]	1.100 [27.94]	2-87456-0	1-87456-9	86177-3
26	1.300 [33.02]	1.200 [30.48]	2-87456-2	2-87456-1	86177-4
28	1.400 [35.56]	1.300 [33.02]	2-87456-4	2-87456-3	86177-5
30	1.500 [38.10]	1.400 [35.56]	2-87456-6	2-87456-5	86177-6
32	1.600 [40.64]	1.500 [38.10]	2-87456-8	2-87456-7	86177-7
34	1.700 [43.18]	1.600 [40.64]	3-87456-0	2-87456-9	86177-8
36	1.800 [45.72]	1.700 [43.18]	3-87456-2	3-87456-1	86177-9
38	1.900 [48.26]	1.800 [45.72]	—	3-87456-3	1-86177-0
40	2.000 [50.80]	1.900 [48.26]	3-87456-6	3-87456-5	1-86177-1
42	2.100 [53.34]	2.000 [50.80]	4-87456-4	4-87456-3	—
44	2.200 [55.88]	2.100 [53.34]	3-87456-8	3-87456-7	1-86177-7
48	2.400 [60.96]	2.300 [58.42]	6-87456-0	5-87456-9	2-86177-3
50	2.500 [63.50]	2.400 [60.96]	4-87456-0	3-87456-9	2-86177-1
52	2.600 [66.04]	2.500 [63.50]	4-87456-2	4-87456-1	1-86177-9
54	2.700 [68.58]	2.600 [66.04]	—	4-87456-5	—
56	2.800 [71.12]	2.700 [68.58]	—	6-87456-1	—
58	2.900 [73.66]	2.800 [71.12]	—	6-87456-3	—
60	3.000 [76.20]	2.900 [73.66]	5-87456-2	5-87456-1	—
64	3.200 [81.28]	3.100 [78.74]	6-87456-6	6-87456-5	—
66	3.300 [83.82]	3.200 [81.28]	5-87456-4	5-87456-7	—
70	3.500 [88.90]	3.400 [86.36]	—	5-87456-5	2-86177-4
72	3.600 [91.44]	3.500 [88.90]	4-87456-8	4-87456-7	—

\*Cavity identification, part number and date code stamped on housing where size permits.

\*\*No marking on housing.

**Notes:** 1. Strain reliefs are available and may be purchased separately. Consult TE.

2. Contact **Extraction/Lance Reset Tool No. 843996-3**.

**Note:** All part numbers are RoHS compliant.



## Mod IV Wire-Applied Housings, Double-Row, .100 x .100 [2.54 x 2.54] Centerline (Continued)

### Polarized



### Material

Black thermoplastic, flame retardant

### Related Product Data

**Contacts** — pages 211-213  
**Mateable Headers and Posts** — pages 117-131

**Technical Documents** — pages 277, 278

**Product Specification**  
 108-25007, 108-25019, 108-25020, 108-25021

**Application Specification**  
 114-25003, 114-25016

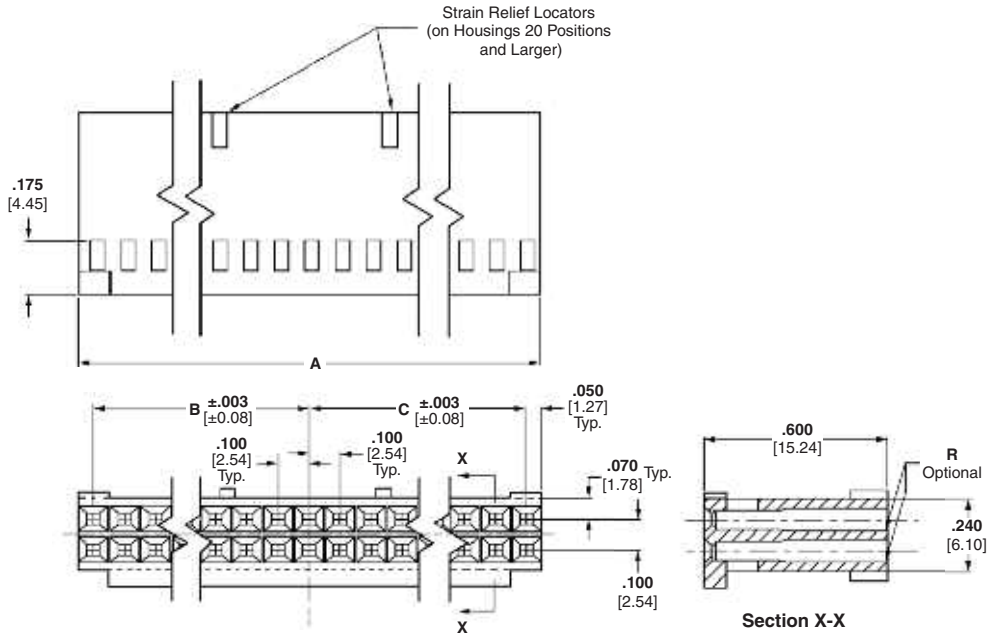

No. of Pos.	Dimensions			Part Nos.	
	A	B	C	Stamped*	Unstamped**
6	.300 [7.62]	.100 [2.54]	.100 [2.54]	87977-1	2-87977-8
8	.400 [10.16]	.200 [5.08]	.100 [2.54]	87977-2	2-87977-9
10	.500 [12.70]	.200 [5.08]	.200 [5.08]	87977-3	3-87977-0
12	.600 [15.24]	.300 [7.62]	.200 [5.08]	87977-4	3-87977-1
14	.700 [17.78]	.300 [7.62]	.300 [7.62]	87977-5	3-87977-2
16	.800 [20.32]	.400 [10.16]	.300 [7.62]	87977-6	3-87977-3
18	.900 [22.86]	.400 [10.16]	.400 [10.16]	—	3-87977-4
20	1.000 [25.40]	.500 [12.70]	.400 [10.16]	87977-8	3-87977-5
22	1.100 [27.94]	.500 [12.70]	.500 [12.70]	—	3-87977-6
24	1.200 [30.48]	.600 [15.24]	.500 [12.70]	1-87977-0	3-87977-7
26	1.300 [33.02]	.600 [15.24]	.600 [15.24]	1-87977-1	3-87977-8
28	1.400 [35.56]	.700 [17.78]	.600 [15.24]	—	3-87977-9
30	1.500 [38.10]	.700 [17.78]	.700 [17.78]	—	4-87977-0
32	1.600 [40.64]	.800 [20.32]	.700 [17.78]	—	4-87977-1
34	1.700 [43.18]	.800 [20.32]	.800 [20.32]	—	4-87977-2
36	1.800 [45.72]	.900 [22.86]	.800 [20.32]	—	4-87977-3
38	1.900 [48.26]	.900 [22.86]	.900 [22.86]	—	4-87977-4
40	2.000 [50.80]	1.000 [25.40]	.900 [22.86]	1-87977-8	4-87977-5
42	2.100 [53.34]	1.000 [25.40]	1.000 [25.40]	—	4-87977-6
44	2.200 [55.88]	1.100 [27.94]	1.000 [25.40]	—	4-87977-7
48	2.400 [60.96]	1.200 [30.48]	1.100 [27.94]	—	5-87977-6
50	2.500 [63.50]	1.200 [30.48]	1.200 [30.48]	2-87977-1	4-87977-8
52	2.600 [66.04]	1.300 [33.02]	1.200 [30.48]	—	4-87977-9
54	2.700 [68.58]	1.300 [33.02]	1.300 [33.02]	—	5-87977-0
56	2.800 [71.12]	1.400 [35.56]	1.300 [33.02]	—	5-87977-8
58	2.900 [73.66]	1.400 [35.56]	1.400 [35.56]	—	6-87977-0
60	3.000 [76.20]	1.500 [38.10]	1.400 [35.56]	2-87977-4	5-87977-1
64	3.200 [81.28]	1.600 [40.64]	1.500 [38.10]	—	6-87977-2
66	3.300 [83.82]	1.600 [40.64]	1.600 [40.64]	—	5-87977-2
70	3.500 [88.90]	1.700 [43.18]	1.700 [43.18]	—	5-87977-3
72	3.600 [91.44]	1.800 [45.72]	1.700 [43.18]	—	5-87977-4

\*Cavity identification, part number and date code stamped on housing where size permits.

\*\*No marking on housing or strain relief.

**Notes:** 1. Strain reliefs are available and may be purchased separately. Consult TE.  
 2. Contact **Extraction/Lance Reset Tool No. 843996-3**.

**Note:** All part numbers are RoHS compliant.

### Keying Plugs

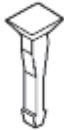

**Part No. 86286-1**

(Plugs into standard or intermediate pressure receptacle contact)

**Material** — Natural color nylon

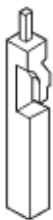

**Part No. 87077-2**

(Plugs directly into housing)

## Mod IV Wire-Applied Housings, Double-Row, .100 x .100 [2.54 x 2.54] Centerline (Continued)

**Polarized (with Detent Latching, with and without Strain Relief/Pull Tab)**



**Material**

Black thermoplastic, flame retardant

**Related Product Data**

**Contacts** — pages 211-213  
**Mateable Headers and Posts** — pages 117-125, 127-133

**Technical Documents** — pages 277, 278

**Product Specification**  
 108-25007, 108-25019, 108-25020, 108-25021

**Application Specification**  
 114-25003, 114-25016

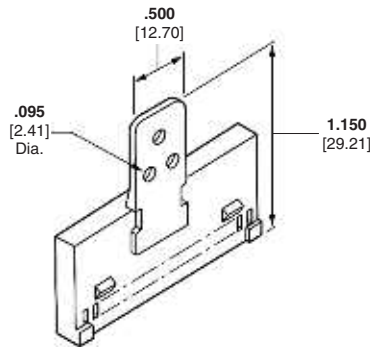
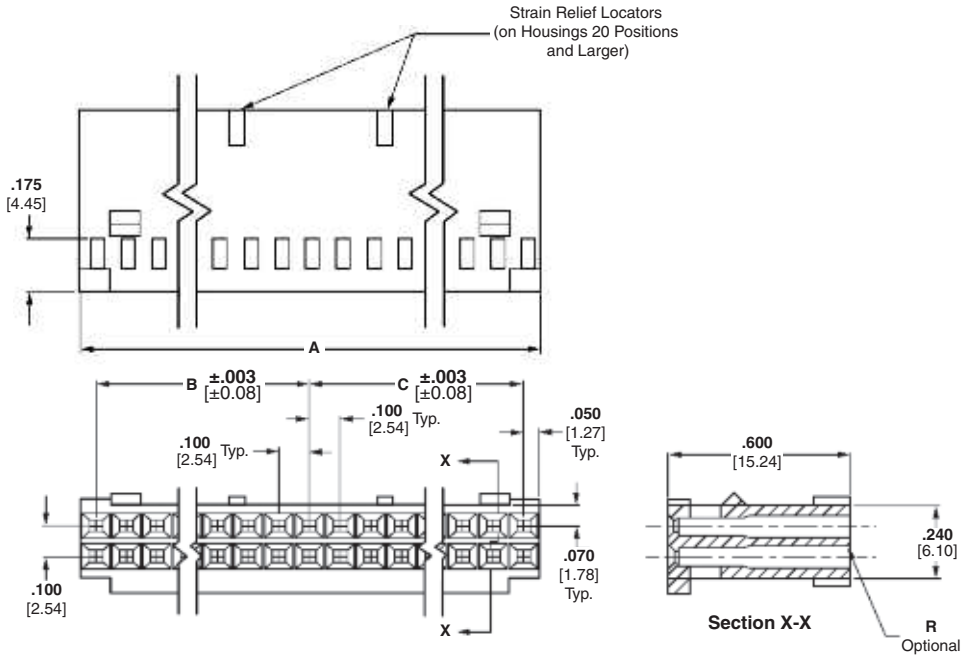

**Housing with Strain Relief/Pull Tab**  
 Strain Relief Part No. 87921-1  
 (10 thru 18 positions)

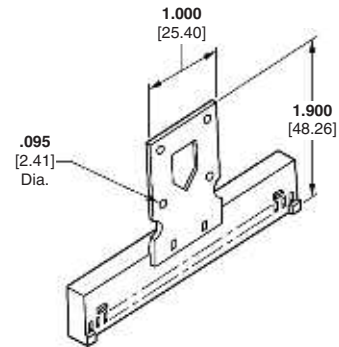

**Housing with Strain Relief/Pull Tab**  
 Strain Relief Part No. 87710-1  
 (20 positions and larger)

**Keying Plugs**

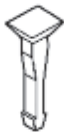

**Part No. 86286-1**  
 (Plugs into standard or intermediate pressure receptacle contact)

**Material** — Natural color nylon

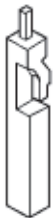

**Part No. 87077-2**  
 (Plugs directly into housing)

No. of Pos.	Dimensions			No. of Detents	Part Nos.		
	A	B	C		Without Strain Relief		With Strain Relief
					Stamped*	Unstamped**	
6	.300 [7.62]	.100 [2.54]	.100 [2.54]	1	87631-2	87631-1	—
8	.400 [10.16]	.200 [5.08]	.100 [2.54]	1	87631-4	87631-3	—
10	.500 [12.70]	.200 [5.08]	.200 [5.08]	1	87631-6	87631-5	87922-1
12	.600 [15.24]	.300 [7.62]	.200 [5.08]	1	87631-8	87631-7	87922-2
14	.700 [17.78]	.300 [7.62]	.300 [7.62]	1	1-87631-0	87631-9	87922-3
16	.800 [20.32]	.400 [10.16]	.300 [7.62]	1	1-87631-2	1-87631-1	87922-4

\*Cavity identification, part number and date code stamped on housing and/or strain relief where size permits.

\*\*No marking on housing or strain relief.

- Notes:**
1. The Strain Relief/Pull Tab can be bonded to any thermoplastic connector housing.
  2. Strain reliefs may be purchased separately.
  3. Contact **Extraction/Lance Reset Tool No. 843996-3**.

**Note:** All part numbers are RoHS compliant.

**Mod IV Wire-Applied Housings, Double-Row,  
.100 x .100 [2.54 x 2.54] Centerline** (Continued)

No. of Pos.	Dimensions			No. of Detents	Part Nos.		
	A	B	C		Without Strain Relief		With Strain Relief
					Stamped*	Unstamped**	Stamped*
18	.900 [22.86]	.400 [10.16]	.400 [10.16]	1	1-87631-4	1-87631-3	87922-5
20	1.000 [25.40]	.500 [12.70]	.400 [10.16]	2	1-87631-6	1-87631-5	87733-1
22	1.100 [27.94]	.500 [12.70]	.500 [12.70]	2	1-87631-8	1-87631-7	—
24	1.200 [30.48]	.600 [15.24]	.500 [12.70]	2	2-87631-0	1-87631-9	87733-3
26	1.300 [33.02]	.600 [15.24]	.600 [15.24]	2	2-87631-2	2-87631-1	87733-4
28	1.400 [35.56]	.700 [17.78]	.600 [15.24]	2	2-87631-4	2-87631-3	—
30	1.500 [38.10]	.700 [17.78]	.700 [17.78]	2	2-87631-6	2-87631-5	87733-6
32	1.600 [40.64]	.800 [20.32]	.700 [17.78]	2	2-87631-8	2-87631-7	87733-7
34	1.700 [43.18]	.800 [20.32]	.800 [20.32]	2	3-87631-0	2-87631-9	87733-8
36	1.800 [45.72]	.900 [22.86]	.800 [20.32]	2	3-87631-2	3-87631-1	—
38	1.900 [48.26]	.900 [22.86]	.900 [22.86]	2	—	3-87631-3	—
40	2.000 [50.80]	1.000 [25.40]	.900 [22.86]	2	3-87631-6	3-87631-5	1-87733-1
42	2.100 [53.34]	1.000 [25.40]	1.000 [25.40]	2	3-87631-8	3-87631-7	—
44	2.200 [55.88]	1.100 [27.94]	1.000 [25.40]	2	4-87631-0	3-87631-9	—
48	2.400 [60.96]	1.200 [30.48]	1.100 [27.94]	2	—	5-87631-9	—
50	2.500 [63.50]	1.200 [30.48]	1.200 [30.48]	2	4-87631-2	4-87631-1	1-87733-4
52	2.600 [66.04]	1.300 [33.02]	1.200 [30.48]	2	—	4-87631-3	—
54	2.700 [68.58]	1.300 [33.02]	1.300 [33.02]	2	4-87631-6	4-87631-5	—
58	2.900 [73.66]	1.400 [35.56]	1.400 [35.56]	2	—	6-87631-3	—
60	3.000 [76.20]	1.500 [38.10]	1.400 [35.56]	2	5-87631-2	5-87631-1	1-87733-7
64	3.200 [81.28]	1.600 [40.64]	1.500 [38.10]	2	6-87631-6	6-87631-5	—
66	3.300 [83.82]	1.600 [40.64]	1.600 [40.64]	2	—	5-87631-3	—
70	3.500 [88.90]	1.700 [43.18]	1.700 [43.18]	2	—	5-87631-5	—
72	3.800 [96.52]	1.800 [45.72]	1.700 [43.18]	2	5-87631-8	5-87631-7	—

\*Cavity identification, part number and date code stamped on housing and/or strain relief where size permits.

\*\*No marking on housing or strain relief.

- Notes:** 1. The Strain Relief/Pull Tab can be bonded to any thermoplastic connector housing.  
2. Strain reliefs may be purchased separately.  
3. Contact **Extraction/Lance Reset Tool No. 843996-3**.

**Note:** All part numbers are RoHS compliant.

## Mod IV Wire-Applied Housings, Double-Row, .100 x .100 [2.54 x 2.54] Centerline (Continued)

### Center Polarized



#### Material

Black thermoplastic, flame retardant

#### Related Product Data

**Contacts** — pages 211-213  
**Mateable Headers and Posts** —  
**AMP-LATCH Low Profile Headers, Shrouded** — pages 135-140

**Technical Documents** —  
 pages 277, 278

**Product Specification**  
 108-25007, 108-25019, 108-25020,  
 108-25021

**Application Specification**  
 114-25003, 114-25016

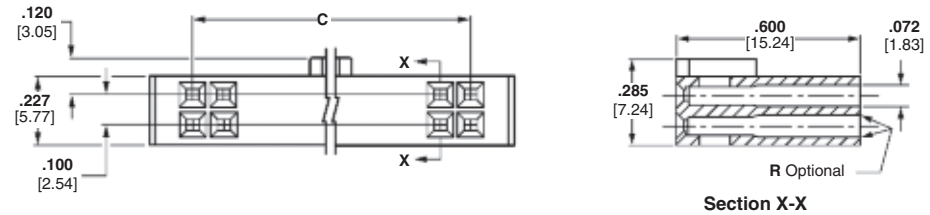
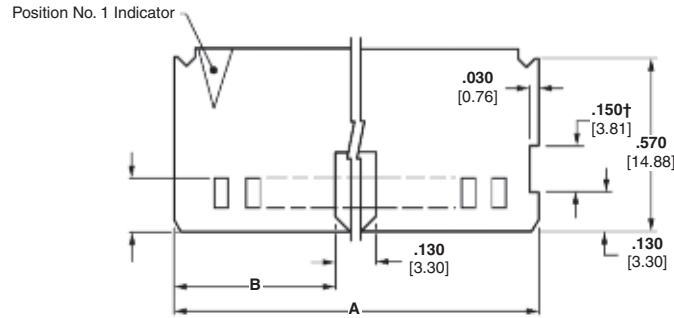

No. of Pos.	Dimensions			Part Nos. (Stamped*)
	A	B	C	
8	.580 [14.73]	.225 [5.72]	.300 [7.62]	1-102387-4
10	.680 [17.27]	.275 [6.98]	.400 [10.16]	102387-1
14	.880 [22.35]	.375 [9.53]	.600 [15.24]	102387-2
16	.980 [24.89]	.425 [10.80]	.700 [17.78]	102387-3
20	1.180 [29.97]	.525 [13.34]	.900 [22.86]	102387-4
22	1.280 [32.51]	.575 [14.61]	1.000 [25.40]	1-102387-5
24	1.380 [35.05]	.625 [15.88]	1.100 [27.94]	102387-5
26	1.480 [37.59]	.675 [17.15]	1.200 [30.48]	102387-6
30	1.680 [42.67]	.775 [19.69]	1.400 [35.56]	102387-7
34	1.880 [47.75]	.875 [22.23]	1.600 [40.64]	102387-8
40	2.180 [55.37]	1.025 [26.04]	1.900 [48.26]	102387-9
44	2.380 [60.45]	1.125 [28.58]	2.100 [53.34]	1-102387-3
50	2.680 [68.07]	1.275 [32.39]	2.400 [60.96]	1-102387-0
60	3.180 [80.77]	1.525 [38.74]	2.900 [73.66]	1-102387-1
64	3.380 [85.85]	1.625 [41.28]	3.100 [78.74]	1-102387-2

\*Cavity identification and TE stamped on housing.

†Non-functional slot is used for gating purposes during injection molding process. This gating feature is not inherent in all production molds. Therefore, the depicted slot will only be present on housings produced on mold tooling requiring this gating feature.

**Note:** Contact **Extraction/Lance Reset Tool No. 843996-3**.

### Keying Plugs

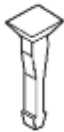

**Part No. 86286-1**

(Plugs into standard or intermediate pressure receptacle contact)

**Material** — Natural color nylon

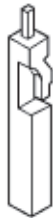

**Part No. 87077-2**

(Plugs directly into housing)

**Note:** All part numbers are RoHS compliant.

## Short Point, Crimp Snap-In Wire-Applied Contacts and Housings

### Product Facts

- Short point of contact mates with .169 [4.29] to .259 [6.58] long post
- Double-row housings are end-to-end and side-to-side stackable
- Terminates 32-20 AWG [0.03-0.6 mm<sup>2</sup>] discrete wire
- Contacts have insulation support to accept a maximum insulation diameter of .060 [1.52]
- Available with .000015 [0.00038] or .000030 [0.00076] gold duplex, or tin plating
- Mates with .025 [0.64] square posts
- Dual cantilever contact beams for reliable matings
- Locking retention latch provides approximately 3 lb [13.34 N] of retention force
- Unique locking latch design helps prevent latch from protruding through latch window
- Contacts snap into AMPMODU MTE single-row housings
- Double-row housing configurations include .100 [2.54] centerline, plain and polarized
- Housing sizes range from 4 to 52 positions
- Recognized under the Component Program of Underwriters Laboratories Inc., File No. E28476
- Certified by Canadian Standards Association, File No. LR7189
- Produced under a Quality Management System certified to ISO 9001



A copy of the certificate is available upon request

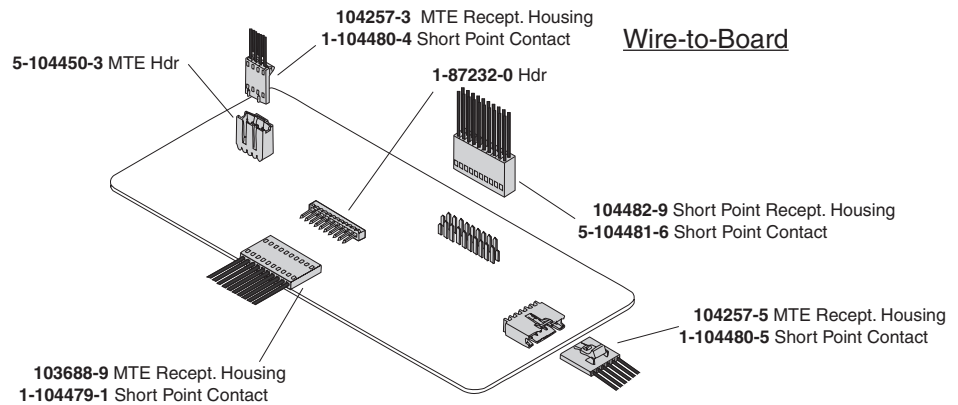
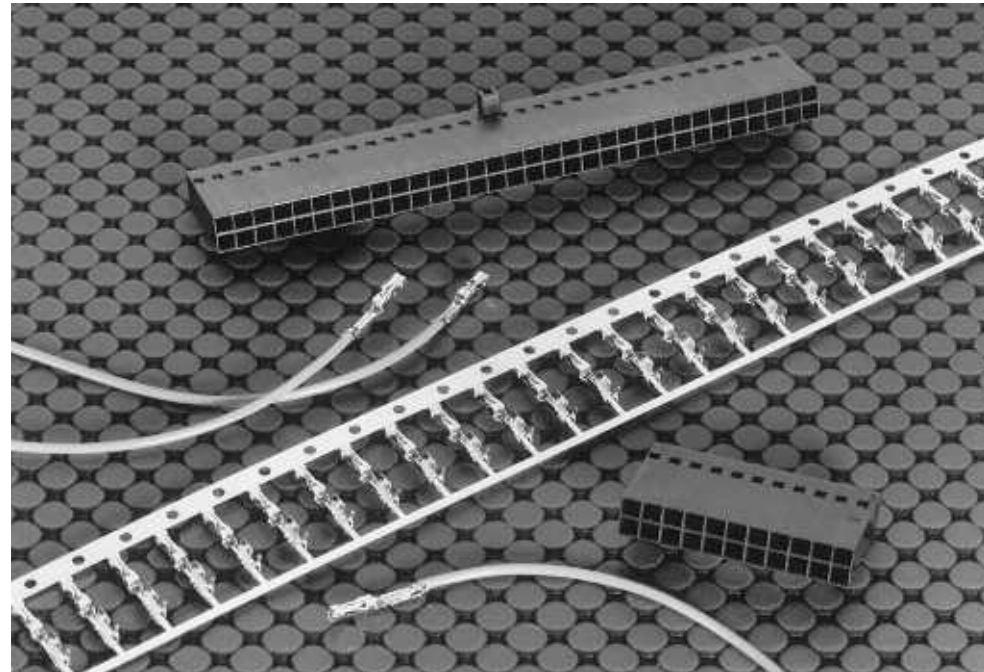

AMPMODU Short Point receptacle contacts are designed to mate with .025 [0.64] square posts. They will mate with posts as short as .169 [4.29].

Short Point double-row housings are end-to-end and side-to-side stackable on .100 [2.54] centers. Contacts also can be used in single-row AMPMODU MTE housings to provide a complete wire-crimp system, or to serve as replacement contacts.

### Performance Characteristics

**Contact Current Rating** — 3 amperes

**Termination Resistance** — 12 milliohms (max.)

**Durability** — Ref. Product Specification 108-1472

**Note:** All part numbers are RoHS compliant.

## Short Point Crimp Snap-In Receptacle Contacts

### Material and Finish

Copper alloy C7025, plated as follows:

**Plating A** — Duplex plated .000030 [0.00076] min. gold on contact area, .000050 [0.00127] min. tin in crimp area, with entire contact underplated .000050 [0.00127] min. nickel

**Plating B** — Duplex plated .000015 [0.00038] min. gold on contact area, .000050 [0.00127] min. tin in crimp area, with entire contact underplated .000050 [0.00127] min. nickel

**Plating C** — .000100 [0.00254] min. tin over .000050 [0.00127] min. nickel on entire contact

### Related Product Data

**Performance Characteristics** — page 221

**Housings used in** — Short Point—pages 223, 224

**AMPMODU MTE Unloaded Housings** — pages 228-233

**Application Tooling** — page 270-272

**Technical Documents** — pages 276-278

**Product Specification** 108-1472

**Application Specification** 114-25038

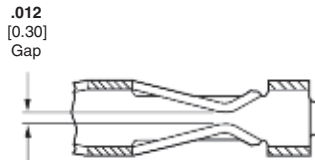
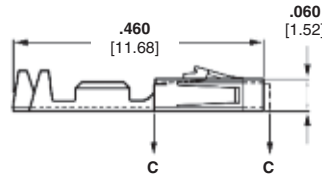
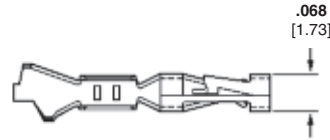

Section C - C



**Keying Plug**  
Part No. 104072-1

Ten plugs are supplied per strip. Order quantity reflects the number of strips required.



**Extraction/Lance Reset**  
Tool No. 843477-1

Wire Size Range		Ins. Dia. Range	Finish	Contact Part No. (Standard Pressure)		Quick-Change Applicator for AMP-O-LECTRIC Machine*	Applicator for AMP-O-MATIC Stripper/Crimper Machine	Hand Tool Nos.
AWG	[mm <sup>2</sup> ]			Strip Form	Loose Piece			
32-28	0.03-0.08	.025-.060 [0.64-1.52]	Plating A	1-104481-1	1-104481-3	567296-2	466980-1	91518-1
			Plating B	1-104481-0	1-104481-2			
			Plating C	5-104481-2	5-104481-6			
26-22	0.13-0.3	.025-.060 [0.64-1.52]	Plating A	1-104480-3	1-104480-6	567297-2	466981-1	91518-1
			Plating B	1-104480-2	1-104480-5			
			Plating C	1-104480-7	1-104480-4			
24-20	0.2-0.5	.025-.060 [0.64-1.52]	Plating A	1-104479-0	1-104479-3	567298-2	466982-1	91551-1
			Plating B	104479-9	1-104479-2			
			Plating C	104479-8	1-104479-1			

\*For use with Model "K" machines. Call the Tooling/Technical Assistance Center (1-800-722-1111) for part nos. of applicators for use with the Model "G" machines (shown on page 288), as well as other bench machines and fully automatic AMPOMATOR lead making machines.

**Note:** All part numbers are RoHS compliant.

## Short Point Wire-Applied Housings, Double-Row, Non-Polarized, .100 x .100 [2.54 x 2.54] Centerline

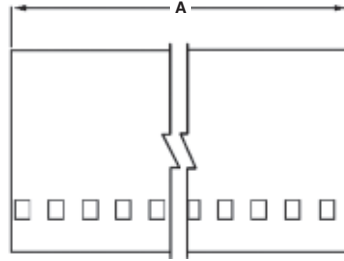

### Material

Black thermoplastic, flame retardant, 94V-0 rated

### Related Product Data

**Performance Characteristics** — page 221

**Contacts** — page 222

**Mateable Headers** — pages 104, 105

**Technical Documents** — pages 276-278

**Product Specification** 108-1472

**Application Specification** 114-25038

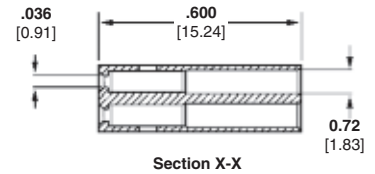
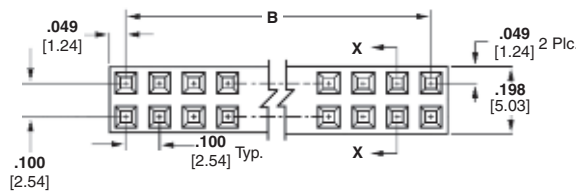

No. of Pos.	Dimensions		Housing Part No.
	A	B	
4	.198 [5.03]	.100 [2.54]	104482-1
6	.298 [7.57]	.200 [5.08]	104482-2
8	.398 [10.11]	.300 [7.62]	104482-3
10	.498 [12.65]	.400 [10.16]	104482-4
12	.598 [15.19]	.500 [12.70]	104482-5
14	.698 [17.73]	.600 [15.24]	104482-6
16	.798 [20.27]	.700 [17.78]	104482-7
18	.898 [22.81]	.800 [20.32]	104482-8
20	.998 [25.35]	.900 [22.86]	104482-9
22	1.098 [27.89]	1.000 [25.40]	1-104482-0
26	1.298 [32.97]	1.200 [30.48]	1-104482-1
28	1.398 [35.51]	1.300 [33.02]	1-104482-2
30	1.498 [38.05]	1.400 [35.56]	1-104482-3
32	1.598 [40.59]	1.500 [38.10]	1-104482-4
34	1.698 [43.13]	1.600 [40.64]	1-104482-5
36	1.798 [45.67]	1.700 [43.18]	1-104482-6
38	1.898 [48.21]	1.800 [45.72]	1-104482-7
40	1.998 [50.75]	1.900 [48.26]	1-104482-8
44	2.198 [55.83]	2.100 [53.34]	1-104482-9
52	2.598 [65.99]	2.500 [63.50]	2-104482-0

**Note:** All part numbers are RoHS compliant.

## Short Point Wire-Applied Housings, Double-Row, Polarized, .100 x .100 [2.54 x 2.54] Centerline

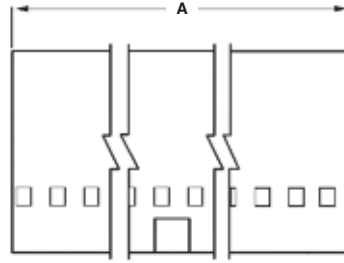

### Material

Black thermoplastic, flame retardant, 94V-0 rated

### Related Product Data

**Performance Characteristics** — page 221

**Contacts** — page 222

**Mateable Headers** — pages 104, 105, 135-138

**Technical Documents** — pages 276-278

**Product Specification** 108-1472

**Application Specification** 114-25038

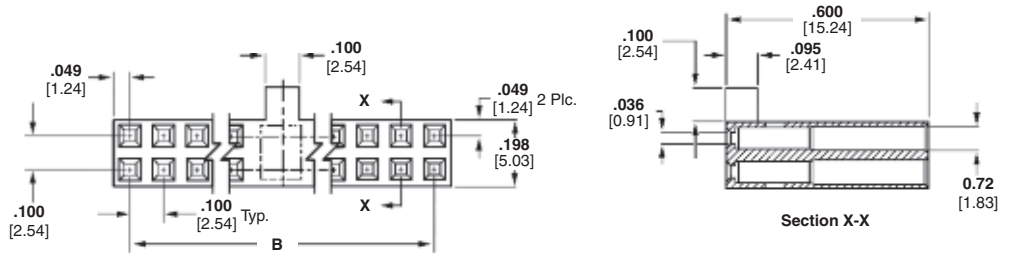

No. of Pos.	Dimensions		Housing Part No.
	A	B	
8	.398 [10.11]	.300 [7.62]	104483-1
10	.498 [12.65]	.400 [10.16]	1-104483-1
12	.598 [15.19]	.500 [12.70]	1-104483-2
14	.698 [17.73]	.600 [15.24]	104483-9
18	.898 [22.81]	.800 [20.32]	104483-2
20	.998 [25.35]	.900 [22.86]	104483-3
26	1.298 [32.97]	1.200 [30.48]	104483-4
30	1.498 [38.05]	1.400 [35.56]	104483-5
38	1.898 [48.21]	1.800 [45.72]	104483-6
50	2.498 [63.45]	2.400 [60.96]	1-104483-3
52	2.598 [65.99]	2.500 [63.50]	1-104483-0
54	2.698 [68.53]	2.600 [66.04]	104483-7
64	3.198 [81.23]	3.100 [78.74]	104483-8



**Note:** Other sizes can be made available on request.

**Note:** All part numbers are RoHS compliant.



## MTE Interconnection System

### Product Facts

- Receptacle assemblies mate with .025 [0.64] sq. posts; mating post length is .200 [5.08] min., .250 [6.35] max.
- Proven AMPMODU receptacle contact design; dual cantilever beams, built-in anti-overstress, completely enclosed "box" design, standard or high-pressure
- Insulation displacement technology
- Two contact sizes for terminating 30-22 AWG [0.05-0.3 mm<sup>2</sup>] wire range; .054 [1.37] max. insulation diameter with an insulation wall thickness of .015 [0.38] max.
- Choice of gold duplex or tin plated contacts
- Interchangeable crimp snap-in pin and receptacle contacts available
- Housing sizes 2 through 25 positions, single-row .100 [2.54] centers
- Plain housings are end-to-end and/or back-to-back stackable for open pin field applications
- Optional header with "swaged tail" feature helps prevent movement prior to flow soldering
- Integral latch provides positive retention between header and receptacle housing
- Coupling shrouds permit ganging of smaller connectors with guide ribs to form larger single- or double-row latching connectors
- Mass terminating tooling provides lowest applied cost for most production needs
- SMT and SMT compatible, high-temp headers available
- Recognized under the Component Program of Underwriters Laboratories Inc., File No. E28476 
- Certified by Canadian Standards Association, File No. LR7189 

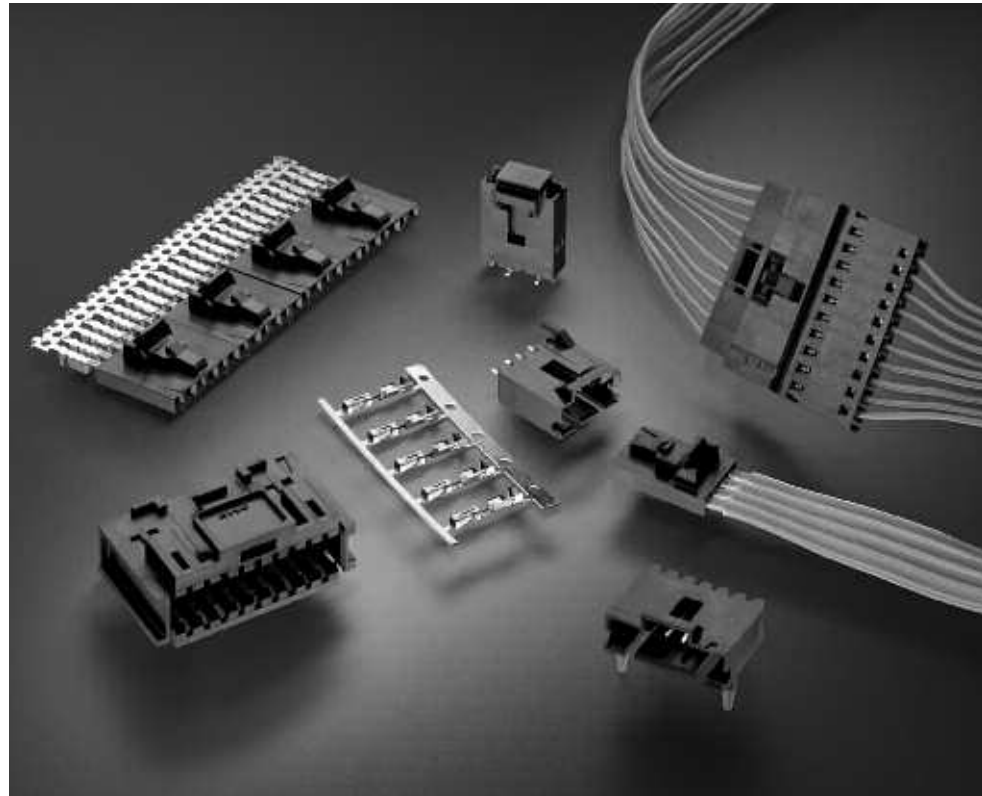

The AMPMODU MTE Interconnection System offers both wire-to-board and wire-to-wire connectors using .025 [0.64] sq. post technology.

The AMPMODU MTE Interconnection System consists of single-row housings with contacts preloaded on .100 [2.54] centers. Housings are furnished with contacts partially inserted, leaving the termination areas exposed. Final contact insertion can be accomplished automatically with TE application equipment, and manually when terminated with the TE pistol grip hand tool.

The heart of the system is the insulation displacement contact design, featured in both pin and receptacle contacts. The receptacle contact, available in either

standard or high-pressure, features dual cantilever beams in an enclosed "box." The post stop helps prevent a mating post from disturbing the wire termination and also limits the mating depth of a long post to protect a wrap-type termination at the base of the post. The forward contact stop helps prevent contact overinsertion prior to termination. All contacts are furnished on carrier strips which are interlocked for stability and positive location during termination.

Single-row housings are available in sizes 2 through 25 positions. Included are three styles of receptacle housings—plain, polarized/latching and ribbed and two styles of pin housings, shrouded with polarizing/latching feature and ribbed.

### Performance Specifications

#### Electrical Characteristics

##### Contact Current Rating —

3 amperes for single contact in free air (Amperage could vary due to ambient temperature, wire size and duty cycles.)

##### Contact Termination Resistance —

15 milliohms (max.)

##### Dielectric Withstanding Voltage —

At Sea Level—600 VAC, rms  
At 70,000 Ft. [21 336 m]—225 VAC, rms

##### Insulation Resistance —

5,000 megohms (min.)

#### Environmental Characteristics

##### Operating Temperature —

-65°C to +105°C

##### Vibration —

15 G's (gold), 10 G's (tin)

##### Physical Shock —

50 G's

##### Industrial Mixed Flow Gasing —

Class 1 (20 days) (gold)

##### Product Specification

108-25034

##### Application Specification

114-25026

**MTE Interconnection System** (Continued)

**Wire-to-Board**

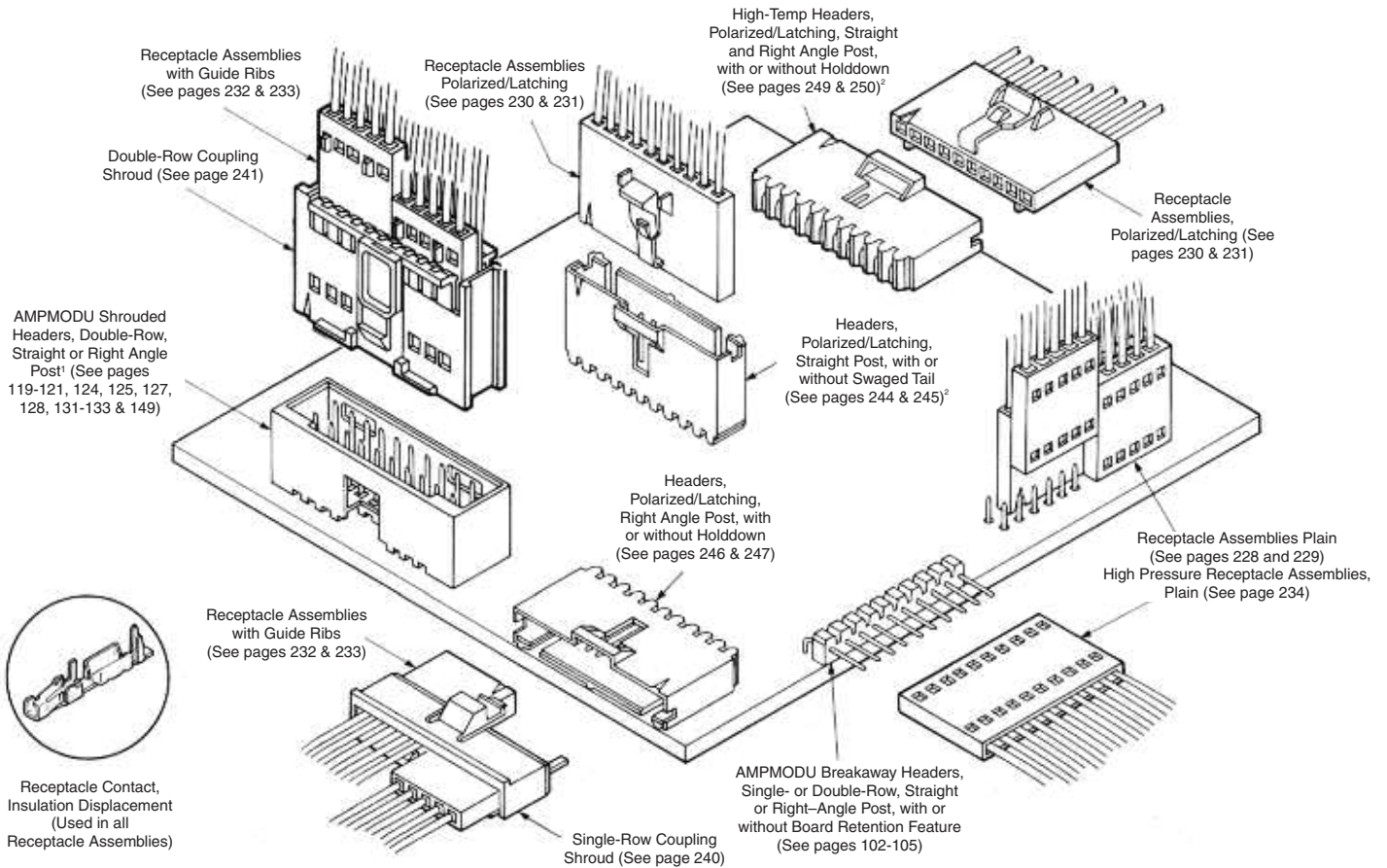

<sup>1</sup>Mating AMPMODU Double-Row Shrouded Header Assemblies must have .318 [8.08] mating post length and .150 [3.81] dimension from centerline of last post to inside of end shroud wall.

<sup>2</sup>Surface Mount Right-Angle and Vertical Headers are also available (see pages 251 and 252)

MTE Interconnection System

5

**MTE Interconnection System** (Continued)

**Wire-to-Wire**

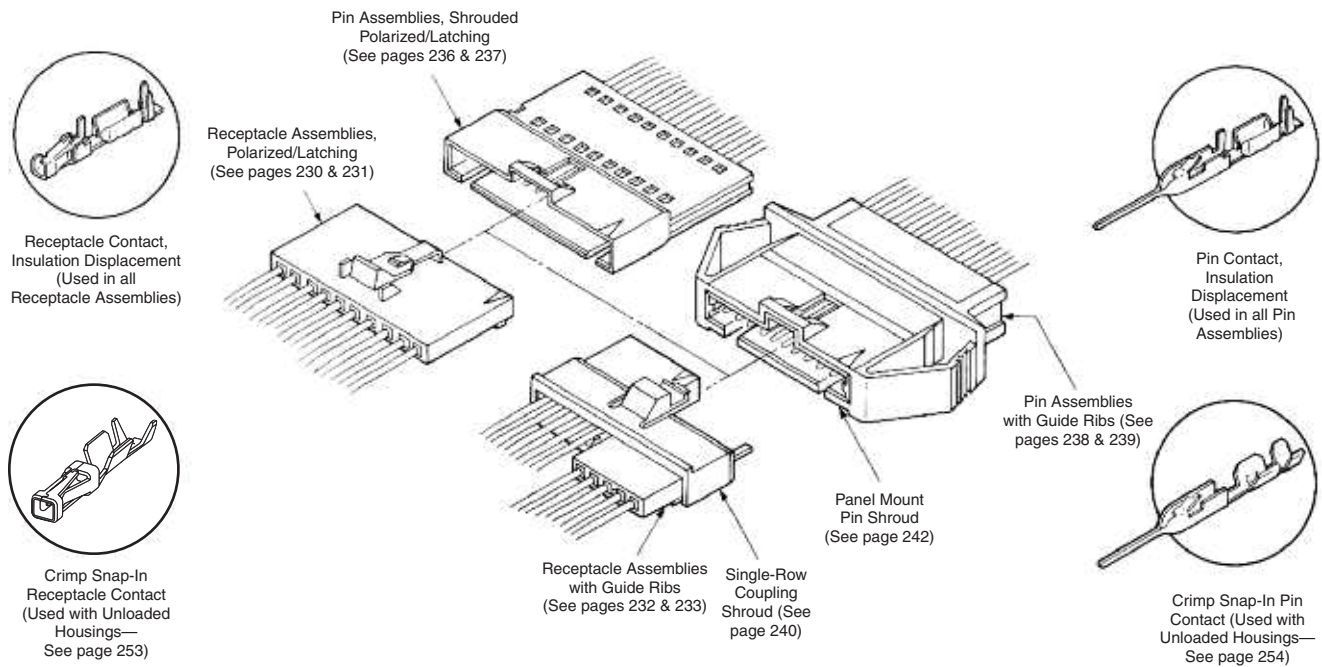

**Note:** For wire-to-wire applications shown above, all pin and receptacle assembly combinations are intermateable.

**MTE Receptacle Assemblies—Plain, Single-Row, .100 [2.54] Centerline**



Preassembled housings in strip form are available in positions 2 thru 12. For ease of handling, positions 2 thru 5 are recommended when using the TE Manual Pistol Grip Tool.

**Material and Finish**

**Housing** — Black thermoplastic, 94V-0 rated

**Contacts** — Phosphor Bronze, plated as follows:

**Plating A** — Duplex plated .000030 [0.00076] gold on contact area, .000050 [0.00127] min. tin in crimp area, with entire contact underplated .000050 [0.00127] nickel

**Plating B** — Duplex plated .000015 [0.00038] gold on contact area, .000050 [0.00127] min. tin in crimp area, with entire contact underplated .000050 [0.00127] nickel

**Plating C** — .000100 [0.00254] tin over .000050 [0.00127] nickel on entire contact

**Note:** Insulation displacement contacts accept an insulation diameter of .030 [0.76] min. to .054 [1.37] max. with an insulation wall thickness of .015 [0.38] max. Mating post length for preloaded housings is .200 [5.08] min., .250 [6.35] max.

**Related Product Data**

**Mateable AMPMODU Products Breakaway Headers** — pages 102-110 (with .230 mating length)

**Reeled Breakaway Headers** — pages 106, 107 (with .230 mating length)

**Machine Applied Bandolier Posts** — page 163

**Single-Row Shrouded Headers with .066 [1.68] End Dimension** — pages 115, 116

**Interchangeable Crimp Contacts (Short Point)** — page 253

**Application Tooling** — page 273

**Performance Specifications** — page 225

**Technical Documents** — pages 277, 278

**Product Specification** 108-25034

**Application Specification** 114-25026

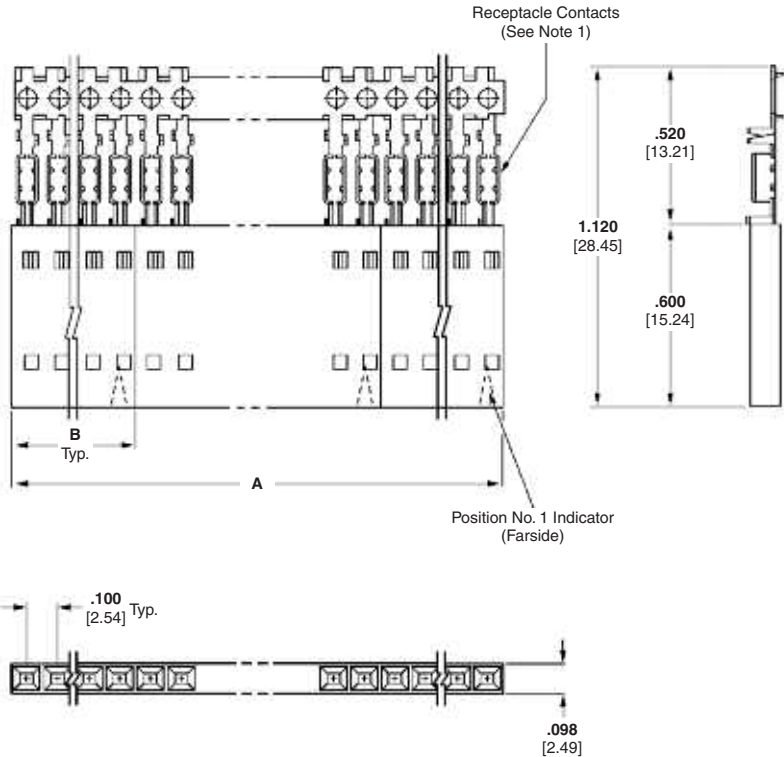

These receptacle assemblies with plain housings can be stacked end-to-end and/or side-to-side for single or double-row connections to an open pin field with a .100 [2.54] centerline grid.

MTE Receptacle Assemblies

5

### MTE Receptacle Assemblies—Strip Form Plain, Single-Row, .100 [2.54] Centerline (Continued)

No. of Pos.	Dimensions		Housing Quantities Per Strip Segment	Strip Form Receptacle Assembly 30-26 AWG [0.05-0.15mm <sup>2</sup> ] Wire			Strip Form Receptacle Assembly 26-22 AWG [0.12-0.3mm <sup>2</sup> ] Wire			Unloaded Housings
	A	B		Plating A	Plating B	Plating C	Plating A	Plating B	Plating C	
2	2.000 [50.80]	.198 [5.03]	10	5-103979-1	5-103978-1	5-103977-1	5-103976-1	5-103975-1	5-103974-1	103688-1
3	2.400 [60.96]	.298 [7.57]	8	5-103979-2	5-103978-2	5-103977-2	5-103976-2	5-103975-2	5-103974-2	103688-2
4	1.990 [50.55]	.398 [10.11]	5	5-103979-3	5-103978-3	5-103977-3	5-103976-3	5-103975-3	5-103974-3	103688-3
5	1.990 [50.55]	.498 [12.65]	4	5-103979-4	5-103978-4	5-103977-4	5-103976-4	5-103975-4	5-103974-4	103688-4
6	2.390 [60.71]	.598 [15.19]	4	5-103979-5	5-103978-5	5-103977-5	5-103976-5	5-103975-5	5-103974-5	103688-5
7	1.400 [35.56]	.698 [17.73]	2	5-103979-6	5-103978-6	5-103977-6	5-103976-6	5-103975-6	5-103974-6	103688-6
8	1.600 [40.64]	.798 [20.27]	2	5-103979-7	5-103978-7	5-103977-7	5-103976-7	5-103975-7	5-103974-7	103688-7
9	1.800 [45.72]	.898 [22.81]	2	5-103979-8	5-103978-8	5-103977-8	5-103976-8	5-103975-8	5-103974-8	103688-8
10	2.000 [50.80]	.998 [23.35]	2	5-103979-9	5-103978-9	5-103977-9	5-103976-9	5-103975-9	5-103974-9	103688-9
11	2.200 [55.88]	1.098 [27.89]	2	6-103979-0	6-103978-0	6-103977-0	6-103976-0	6-103975-0	6-103974-0	1-103688-0
12	2.400 [60.96]	1.198 [30.43]	2	6-103979-1	6-103978-1	6-103977-1	6-103976-1	6-103975-1	6-103974-1	1-103688-1

### MTE Receptacle Assemblies—Individual Form Plain, Single-Row, .100 [2.54] Centerline

No. of Pos.	Dimensions B	Individual Receptacle Assembly 30-26 AWG [0.05-0.15mm <sup>2</sup> ] Wire			Individual Receptacle Assembly 26-22 AWG [0.12-0.3mm <sup>2</sup> ] Wire			Unloaded Housings
		Plating A	Plating B	Plating C	Plating A	Plating B	Plating C	
13	1.298 [32.96]	6-103903-2	6-103684-2	6-103685-2	6-103902-2	6-103686-2	6-103687-2	1-103688-2
14	1.398 [35.51]	6-103903-3	6-103684-3	6-103685-3	6-103902-3	6-103686-3	6-103687-3	1-103688-3
15	1.498 [38.05]	6-103903-4	6-103684-4	6-103685-4	6-103902-4	6-103686-4	6-103687-4	1-103688-4
16	1.598 [40.59]	6-103903-5	6-103684-5	6-103685-5	6-103902-5	6-103686-5	6-103687-5	1-103688-5
17	1.698 [43.13]	6-103903-6	6-103684-6	6-103685-6	6-103902-6	6-103686-6	6-103687-6	1-103688-6
18	1.798 [45.67]	6-103903-7	6-103684-7	6-103685-7	6-103902-7	6-103686-7	6-103687-7	1-103688-7
19	1.898 [48.20]	6-103903-8	6-103684-8	6-103685-8	6-103902-8	6-103686-8	6-103687-8	1-103688-8
20	1.998 [50.75]	6-103903-9	6-103684-9	6-103685-9	6-103902-9	6-103686-9	6-103687-9	1-103688-9
21	2.098 [53.29]	7-103903-0	7-103684-0	7-103685-0	7-103902-0	7-103686-0	7-103687-0	2-103688-0
22	2.198 [55.83]	7-103903-1	7-103684-1	7-103685-1	7-103902-1	7-103686-1	7-103687-1	2-103688-1
23	2.298 [58.37]	7-103903-2	7-103684-2	7-103685-2	7-103902-2	7-103686-2	7-103687-2	2-103688-2
24	2.398 [60.91]	7-103903-3	7-103684-3	7-103685-3	7-103902-3	7-103686-3	7-103687-3	2-103688-3
25	2.498 [63.45]	7-103903-4	7-103684-4	7-103685-4	7-103902-4	7-103686-4	7-103687-4	2-103688-4

- Notes:** 1. Receptacle assemblies are furnished with strip contacts partially inserted into housing—contacts latched into “preload” windows. Contacts are fully inserted into housings automatically when terminated with TE application machines, or manually when terminated with TE pistol grip hand tool.  
 2. Use **Extraction/Lance Reset Tool No. 843477-1** to remove receptacle contacts.  
 3. Keying plugs are available, see page 253.

**Note:** All part numbers are RoHS compliant.

## MTE Receptacle Assemblies—Polarized/Latching, Single-Row, .100 [2.54] Centerline



Preassembled housings in strip form are available in positions 2 thru 12. For ease of handling, positions 2 thru 5 are recommended when using the TE Manual Pistol Grip Tool.

### Material and Finish

**Housing** — Black thermoplastic, 94V-0 rated

**Contacts** — Phosphor Bronze, plated as follows:

**Plating A** — Duplex plated .000030 [0.00076] gold on contact area, .000050 [0.00127] min. tin in crimp area, with entire contact underplated .000050 [0.00127] nickel

**Plating B** — Duplex plated .000015 [0.00038] gold on contact area, .000050 [0.00127] min. tin in crimp area, with entire contact underplated .000050 [0.00127] nickel

**Plating C** — .000100 [0.00254] tin over .000050 [0.00127] nickel on entire contact

**Note:** Insulation displacement contacts accept an insulation diameter of .030 [0.76] min. to .054 [1.37] max. with an insulation wall thickness of .015 [0.38] max. Mating post length for preloaded housings is .200 [5.08] min., .250 [6.35] max.

### Related Product Data

#### Mateable AMPMODU Products

**Pin Assemblies (Polarized/Latching)** — pages 236, 237

**Pin Assemblies with Guide Ribs (installed in Panel Mount Pin Shroud)** — pages 238, 239, 242

**Headers (Polarized/Latching)** — pages 244-252

**Interchangeable Crimp Contacts (Short Point)** — page 253

**Application Tooling** — page 273

**Performance Specifications** — page 225

**Technical Documents** — pages 277, 278

**Product Specification**  
108-25034

**Application Specification**  
114-25026

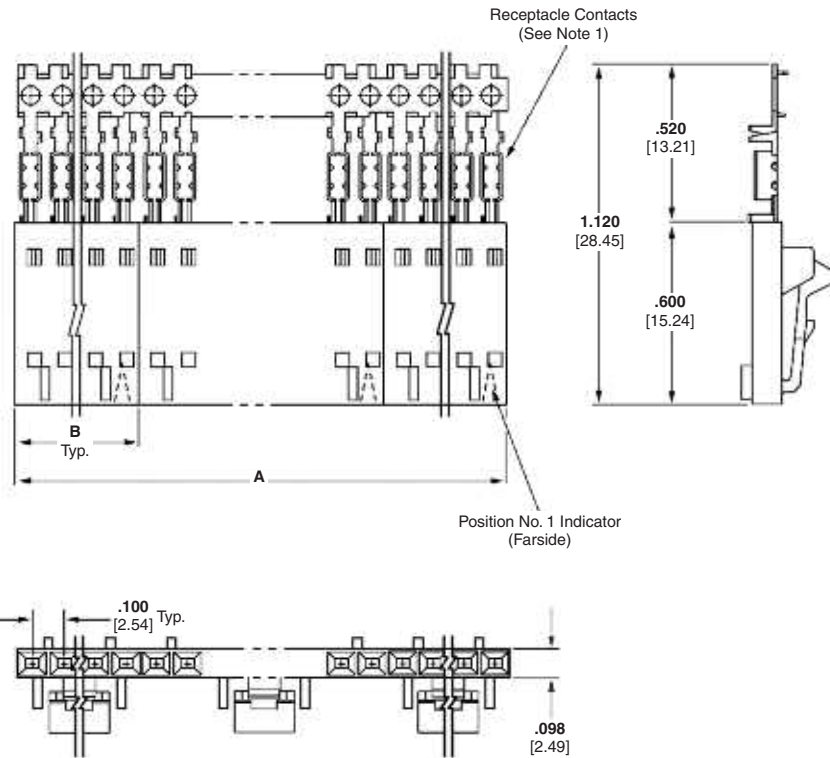

### MTE Receptacle Assemblies—Strip Form Polarized/Latching, Single-Row, .100 [2.54] Centerline (Continued)

No. of Pos.	Dimensions		Housing Quantities Per Strip Segment	Strip Form Receptacle Assembly 30-26 AWG [0.05-0.15mm <sup>2</sup> ] Wire			Strip Form Receptacle Assembly 26-22 AWG [0.12-0.3mm <sup>2</sup> ] Wire			Unloaded Housings
	A	B		Plating A	Plating B	Plating C	Plating A	Plating B	Plating C	
2	2.000 [50.80]	.198 [5.03]	10	5-103961-1	5-103960-1	5-103959-1	5-103958-1	5-103957-1	5-103956-1	104257-1
3	2.400 [60.96]	.298 [7.57]	8	5-103961-2	5-103960-2	5-103959-2	5-103958-2	5-103957-2	5-103956-2	104257-2
4	1.990 [50.55]	.398 [10.11]	5	5-103961-3	5-103960-3	5-103959-3	5-103958-3	5-103957-3	5-103956-3	104257-3
5	1.990 [50.55]	.498 [12.65]	4	5-103961-4	5-103960-4	5-103959-4	5-103958-4	5-103957-4	5-103956-4	104257-4
6	2.390 [60.71]	.598 [15.19]	4	5-103961-5	5-103960-5	5-103959-5	5-103958-5	5-103957-5	5-103956-5	104257-5
7	1.400 [35.56]	.698 [17.73]	2	5-103961-6	5-103960-6	5-103959-6	5-103958-6	5-103957-6	5-103956-6	104257-6
8	1.600 [40.64]	.798 [20.27]	2	5-103961-7	5-103960-7	5-103959-7	5-103958-7	5-103957-7	5-103956-7	104257-7
9	1.800 [45.72]	.898 [22.81]	2	5-103961-8	5-103960-8	5-103959-8	5-103958-8	5-103957-8	5-103956-8	104257-8
10	2.000 [50.80]	.998 [23.35]	2	5-103961-9	5-103960-9	5-103959-9	5-103958-9	5-103957-9	5-103956-9	104257-9
11	2.200 [55.88]	1.098 [27.89]	2	6-103961-0	6-103960-0	6-103959-0	6-103958-0	6-103957-0	6-103956-0	1-104257-0
12	2.400 [60.96]	1.198 [30.43]	2	6-103961-1	6-103960-1	6-103959-1	6-103958-1	6-103957-1	6-103956-1	1-104257-1

### MTE Receptacle Assemblies—Individual Form Polarized/Latching, Single-Row, .100 [2.54] Centerline

No. of Pos.	Dimensions B	Individual Receptacle Assembly 30-26 AWG [0.05-0.15mm <sup>2</sup> ] Wire			Individual Receptacle Assembly 26-22 AWG [0.12-0.3mm <sup>2</sup> ] Wire			Unloaded Housings
		Plating A	Plating B	Plating C	Plating A	Plating B	Plating C	
13	1.298 [32.96]	6-103897-2	6-103640-2	6-103641-2	6-103734-2	6-103644-2	6-103645-2	1-104257-2
14	1.398 [35.51]	6-103897-3	6-103640-3	6-103641-3	6-103734-3	6-103644-3	6-103645-3	1-104257-3
15	1.498 [38.05]	6-103897-4	6-103640-4	6-103641-4	6-103734-4	6-103644-4	6-103645-4	1-104257-4
16	1.598 [40.59]	6-103897-5	6-103640-5	6-103641-5	6-103734-5	6-103644-5	6-103645-5	1-104257-5
17	1.698 [43.13]	6-103897-6	6-103640-6	6-103641-6	6-103734-6	6-103644-6	6-103645-6	1-104257-6
18	1.798 [45.67]	6-103897-7	6-103640-7	6-103641-7	6-103734-7	6-103644-7	6-103645-7	1-104257-7
19	1.898 [48.20]	6-103897-8	6-103640-8	6-103641-8	6-103734-8	6-103644-8	6-103645-8	1-104257-8
20	1.998 [50.75]	6-103897-9	6-103640-9	6-103641-9	6-103734-9	6-103644-9	6-103645-9	1-104257-9
21	2.098 [53.29]	7-103897-0	7-103640-0	7-103641-0	7-103734-0	7-103644-0	7-103645-0	2-104257-0
22	2.198 [55.83]	7-103897-1	7-103640-1	7-103641-1	7-103734-1	7-103644-1	7-103645-1	2-104257-1
23	2.298 [58.37]	7-103897-2	7-103640-2	7-103641-2	7-103734-2	7-103644-2	7-103645-2	2-104257-2
24	2.398 [60.91]	7-103897-3	7-103640-3	7-103641-3	7-103734-3	7-103644-3	7-103645-3	2-104257-3
25	2.498 [63.45]	7-103897-4	7-103640-4	7-103641-4	7-103734-4	7-103644-4	7-103645-4	2-104257-4

**Notes:** 1. Receptacle assemblies are furnished with strip contacts partially inserted into housing—contacts latched into “preload” windows. Contacts are fully inserted into housings automatically when terminated with TE application machines, or manually when terminated with TE pistol grip hand tool.  
 2. Use **Extraction/Lance Reset Tool No. 843477-1** to remove receptacle contacts.  
 3. Keying plugs are available, see page 253.

**Note:** All part numbers are RoHS compliant.

## MTE Receptacle Assemblies—Guide Ribs, Single-Row, .100 [2.54] Centerline



Preassembled housings in strip form are available in positions 2 thru 12. For ease of handling, positions 2 thru 5 are recommended when using the TE Manual Pistol Grip Tool.

### Material and Finish

**Housing** — Black thermoplastic, 94V-0 rated

**Contacts** — Phosphor Bronze, plated as follows:

**Plating A** — Duplex plated .000030 [0.00076] gold on contact area, .000050 [0.00127] min. tin in crimp area, with entire contact underplated .000050 [0.00127] nickel

**Plating B** — Duplex plated .000015 [0.00038] gold on contact area, .000050 [0.00127] min. tin in crimp area, with entire contact underplated .000050 [0.00127] nickel

**Plating C** — .000100 [0.00254] tin over .000050 [0.00127] nickel on entire contact

**Note:** Insulation displacement contacts accept an insulation diameter of .030 [0.76] min. to .054 [1.37] max. with an insulation wall thickness of .015 [0.38] max. Mating post length for preloaded housings is .200 [5.08] min., .250 [6.35] max.

### Related Product Data

**Coupling Shrouds used with —**  
**Single-Row** — page 240  
**Double-Row** — page 241

**Mateable AMPMODU Products (with Receptacle Assemblies Installed in Single-Row Coupling Shrouds) —**

**Pin Assemblies (Polarized/Latching)** — pages 236, 237

**Pin Assemblies with Guide Ribs (installed in Panel Mount Pin Shroud)** — pages 238, 239, 242

**Headers (Polarized/Latching)** — pages 244-252

**Mateable AMPMODU Products (with Receptacle Assemblies Installed in Double-Row Coupling Shrouds) —**

**Headers, Shrouded, Double-Row (.318 [8.08] mating post length, .150 [3.81] end dimension)** — pages 119-121, 124, 125, 128, 129, 131-133

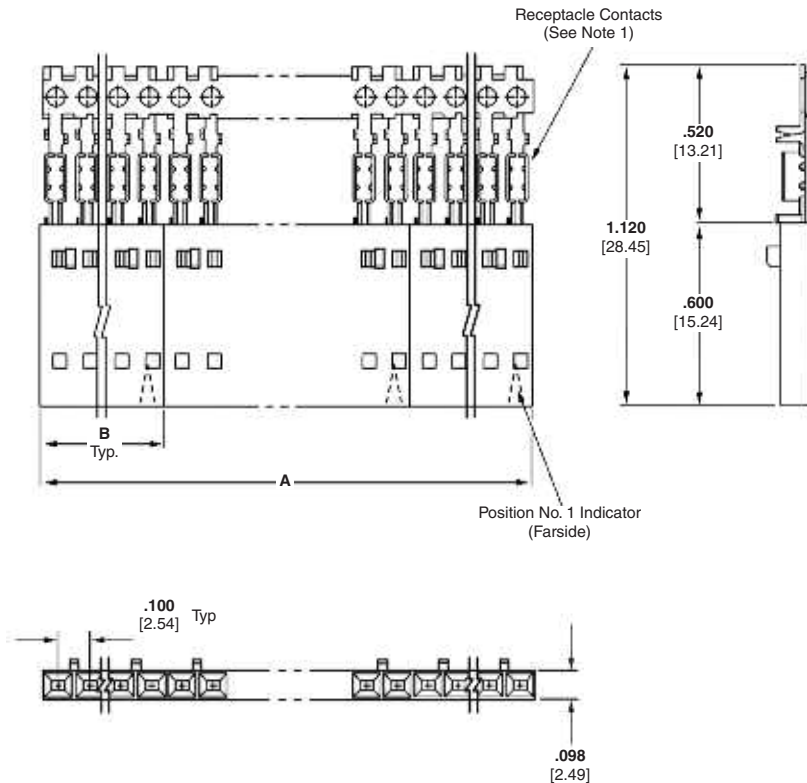

**Interchangeable Crimp Contacts—**  
 (Short Point) — page 253

**Application Tooling** — page 273

**Performance Specifications** — page 225

**Technical Documents** — pages 277, 278

**Product Specification**  
 108-25034

**Application Specification**  
 114-25026



### MTE Receptacle Assemblies—Strip Form with Guide Ribs, Single-Row, .100 [2.54] Centerline (Continued)

No. of Pos.	Dimensions		Housing Quantities Per Strip Segment	Strip Form Receptacle Assembly 30-26 AWG [0.05-0.15mm <sup>2</sup> ] Wire			Strip Form Receptacle Assembly 26-22 AWG [0.12-0.3mm <sup>2</sup> ] Wire			Unloaded Housings
	A	B		Plating A	Plating B	Plating C	Plating A	Plating B	Plating C	
2	2.000 [50.80]	.198 [5.03]	10	5-103973-1	5-103972-1	5-103971-1	5-103970-1	5-103969-1	5-103968-1	103648-1
3	2.400 [60.96]	.298 [7.57]	8	5-103973-2	5-103972-2	5-103971-2	5-103970-2	5-103969-2	5-103968-2	103648-2
4	1.990 [50.55]	.398 [10.11]	5	5-103973-3	5-103972-3	5-103971-3	5-103970-3	5-103969-3	5-103968-3	103648-3
5	1.990 [50.55]	.498 [12.65]	4	5-103973-4	5-103972-4	5-103971-4	5-103970-4	5-103969-4	5-103968-4	103648-4
6	2.390 [60.71]	.598 [15.19]	4	5-103973-5	5-103972-5	5-103971-5	5-103970-5	5-103969-5	5-103968-5	103648-5
7	1.400 [35.56]	.698 [17.73]	2	5-103973-6	5-103972-6	5-103971-6	5-103970-6	5-103969-6	5-103968-6	103648-6
8	1.600 [40.64]	.798 [20.27]	2	5-103973-7	5-103972-7	5-103971-7	5-103970-7	5-103969-7	5-103968-7	103648-7
9	1.800 [45.72]	.898 [22.81]	2	5-103973-8	5-103972-8	5-103971-8	5-103970-8	5-103969-8	5-103968-8	103648-8
10	2.000 [50.80]	.998 [23.35]	2	5-103973-9	5-103972-9	5-103971-9	5-103970-9	5-103969-9	5-103968-9	103648-9
11	2.200 [55.88]	1.098 [27.89]	2	6-103973-0	6-103972-0	6-103971-0	6-103970-0	6-103969-0	6-103968-0	1-103648-0
12	2.400 [60.96]	1.198 [30.43]	2	6-103973-1	6-103972-1	6-103971-1	6-103970-1	6-103969-1	6-103968-1	1-103648-1

### MTE Receptacle Assemblies—Individual Form with Guide Ribs, Single-Row, .100 [2.54] Centerline

No. of Pos.	Dimensions B	Individual Receptacle Assembly 30-26 AWG [0.05-0.15mm <sup>2</sup> ] Wire			Individual Receptacle Assembly 26-22 AWG [0.12-0.3mm <sup>2</sup> ] Wire			Unloaded Housings
		Plating A	Plating B	Plating C	Plating A	Plating B	Plating C	
13	1.298 [32.96]	6-103901-2	6-103649-2	6-103650-2	6-103900-2	6-103651-2	6-103652-2	1-103648-2
14	1.398 [35.51]	6-103901-3	6-103649-3	6-103650-3	6-103900-3	6-103651-3	6-103652-3	1-103648-3
15	1.498 [38.05]	6-103901-4	6-103649-4	6-103650-4	6-103900-4	6-103651-4	6-103652-4	1-103648-4
16	1.598 [40.59]	6-103901-5	6-103649-5	6-103650-5	6-103900-5	6-103651-5	6-103652-5	1-103648-5
17	1.698 [43.13]	6-103901-6	6-103649-6	6-103650-6	6-103900-6	6-103651-6	6-103652-6	1-103648-6
18	1.798 [45.67]	6-103901-7	6-103649-7	6-103650-7	6-103900-7	6-103651-7	6-103652-7	1-103648-7
19	1.898 [48.20]	6-103901-8	6-103649-8	6-103650-8	6-103900-8	6-103651-8	6-103652-8	1-103648-8
20	1.998 [50.75]	6-103901-9	6-103649-9	6-103650-9	6-103900-9	6-103651-9	6-103652-9	1-103648-9
21	2.098 [53.29]	7-103901-0	7-103649-0	7-103650-0	7-103900-0	7-103651-0	7-103652-0	2-103648-0
22	2.198 [55.83]	7-103901-1	7-103649-1	7-103650-1	7-103900-1	7-103651-1	7-103652-1	2-103648-1
23	2.298 [58.37]	7-103901-2	7-103649-2	7-103650-2	7-103900-2	7-103651-2	7-103652-2	2-103648-2
24	2.398 [60.91]	7-103901-3	7-103649-3	7-103650-3	7-103900-3	7-103651-3	7-103652-3	2-103648-3
25	2.498 [63.45]	7-103901-4	7-103649-4	7-103650-4	7-103900-4	7-103651-4	7-103652-4	2-103648-4

- Notes:** 1. Receptacle assemblies are furnished with strip contacts partially inserted into housing—contacts latched into “preload” windows. Contacts are fully inserted into housings automatically when terminated with TE application machines, or manually when terminated with TE pistol grip hand tool.  
 2. Use **Extraction/Lance Reset Tool No. 843477-1** to remove receptacle contacts.  
 3. Keying plugs are available, see page 253.

**Note:** All part numbers are RoHS compliant.

## MTE High Pressure Receptacle Assemblies—Plain, Single-Row, .100 [2.54] Centerline



Preassembled housings in strip form are available in positions 2 thru 12. For ease of handling, positions 2 thru 5 are recommended when using the TE Manual Pistol Grip Tool.

### Material and Finish

**Housing** — Black thermoplastic, 94V-0 rated

**Contacts** — Phosphor Bronze, duplex plated .000030 [0.00076] gold on contact area, .000050 [0.00127] min. tin in crimp area, with entire contact underplated .000050 [0.00127] nickel

**Note:** Insulation displacement contacts accept an insulation diameter of .030 [0.76] min. to .054 [1.37] max. with an insulation wall thickness of .015 [0.38] max. Mating post length for preloaded housings is .200 [5.08] min., .250 [6.35] max.

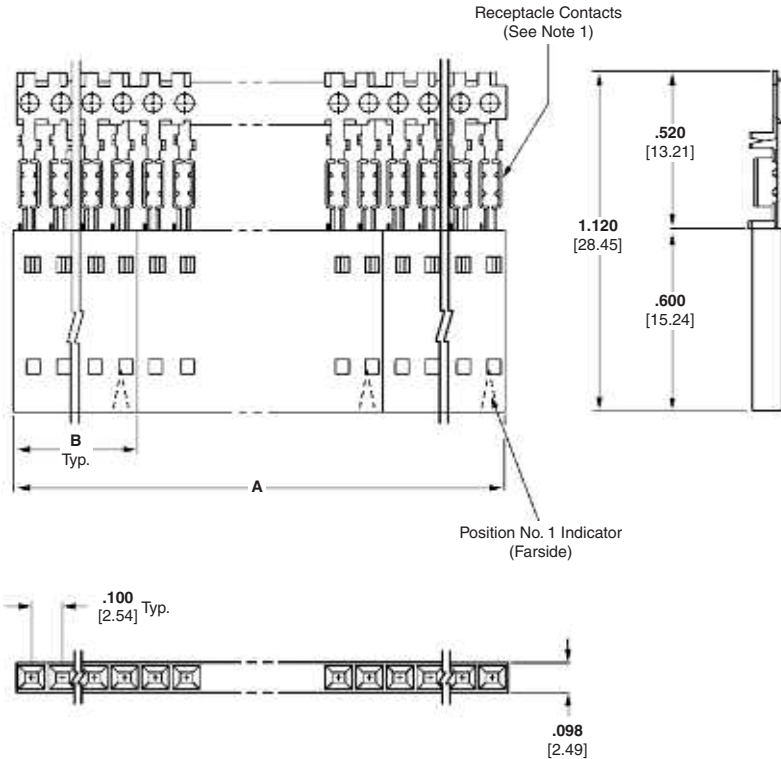

### Related Product Data

#### Mateable AMPMODU Products

**Breakaway Headers** — pages 102-110, (with .230 mating length)

**Reeled Breakaway Headers** — pages 106, 107 (with .230 mating length)

**Machine Applied Bandolier Posts** — page 163

**Application Tooling** — page 273

**Performance Specifications** — page 225

**Technical Documents** — pages 277, 278)

**Product Specification** 108-25034

**Application Specification** 114-25026

No. of Pos.	Dimensions		Housings Quantities Per Strip Segment	Strip Form Receptacle Assembly	Strip Form Receptacle Assembly
	A	B		30-26 AWG [.05-.15mm <sup>2</sup> ] Wire	26-22 AWG [.12-.30mm <sup>2</sup> ] Wire
2	1.980 [50.29]	.198 [5.03]	10	5-104438-1	5-104439-1
3	1.490 [37.85]	.298 [7.57]	5	5-104438-2	5-104439-2
4	1.990 [50.55]	.398 [10.11]	5	5-104438-3	5-104439-3
5	1.990 [50.55]	.498 [12.65]	4	5-104438-4	5-104439-4
6	2.390 [60.71]	.598 [15.19]	4	5-104438-5	5-104439-5
7	1.400 [35.56]	.698 [17.73]	2	5-104438-6	5-104439-6
8	1.600 [40.64]	.798 [20.27]	2	5-104438-7	5-104439-7
9	1.800 [45.72]	.898 [22.81]	2	5-104438-8	5-104439-8
10	2.000 [50.80]	.998 [23.35]	2	5-104438-9	5-104439-9
11	2.200 [55.88]	1.098 [27.89]	2	6-104438-0	6-104439-0
12	2.400 [60.96]	1.198 [30.43]	2	6-104438-1	6-104439-1

- Notes:**
1. Receptacle assemblies are furnished with strip contacts partially inserted into housing—contacts latched into “preload” windows. Contacts are fully inserted into housings automatically when terminated with TE application machines, or manually when terminated with TE pistol grip hand tool.
  2. High pressure receptacle contacts can be made available in other housing styles and position sizes. Contact your TE sales representative.

**Note:** All part numbers are RoHS compliant.

## MTE High Pressure Receptacle Assemblies – Guide Ribs



Preassembled housings in strip form are available in positions 2 thru 12. For ease of handling, positions 2 thru 5 are recommended when using the TE Manual Pistol Grip Tool.

### Material and Finish

**Housing** — Thermoplastic, black, 94V-0 rated

**Contacts** — Phosphor Bronze, duplex plated .000030 [0.00076] gold on contact area, .000050 [0.00127] min. tin on crimp area, with entire contact underplated .000050 [0.00127] nickel.

### Related Product Data

**Coupling Shrouds used with — Single-Row** — page 240

**Double-Row** — page 241

**Mateable AMPMODU Products (with Receptacle Assemblies Installed in Single-Row Coupling Shrouds)** —

**Pin Assemblies (Polarized/Latching)** — pages 236, 237

**Pin Assemblies with Guide Ribs (installed in Panel Mount Pin Shroud)** — pages 238, 239, 242

**Headers (Polarized/Latching)** — pages 244-252

**Mateable AMPMODU Products (with Receptacle Assemblies Installed in Double-Row Coupling Shrouds)** —

**Headers, Shrouded, Double-Row (.318 [8.08] mating post length, .150 [3.81] end dimension)** — pages 119-121, 124, 125, 128, 129, 131-133

**Application Tooling** — page 273

**Performance Specifications** — page 225

**Technical Documents** — pages 277, 278

**Product Specification** 108-25034

**Application Specification** 114-25026

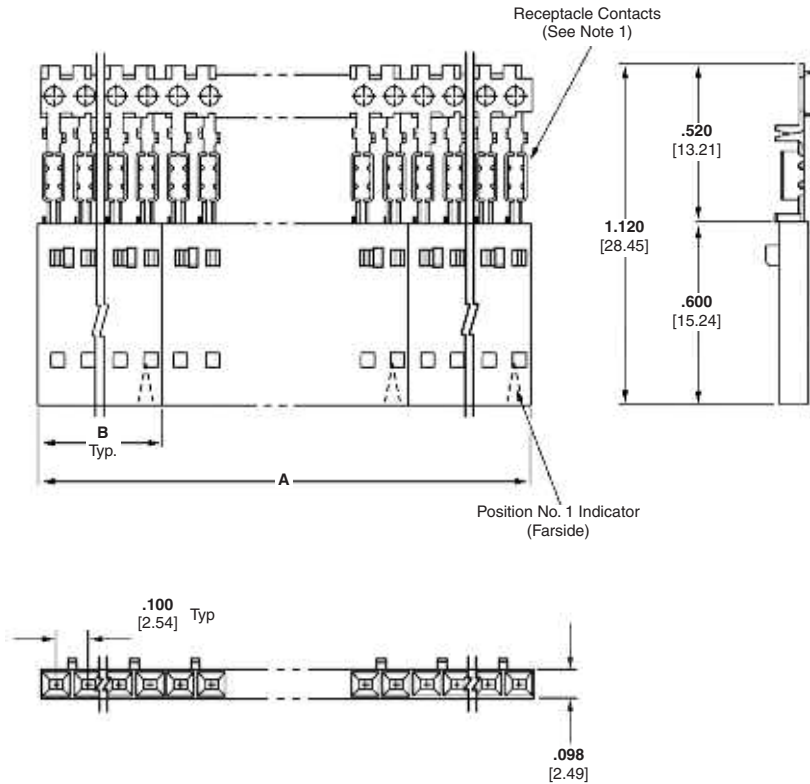

No. of Pos.	Dimensions		Housings Quantities Per Strip Segment	Strip Form Receptacle Assembly 30-26 AWG [.05-.15mm <sup>2</sup> ] Wire	Strip Form Receptacle Assembly 26-22 AWG [.12-.30mm <sup>2</sup> ] Wire
	A	B			
2	1.980 [50.29]	.198 [5.03]	10	5-147396-1	5-147030-3
3	1.490 [37.85]	.298 [7.57]	5	5-147396-2	5-147030-4
4	1.990 [50.55]	.398 [10.11]	5	5-147396-3	5-147030-1
5	1.990 [50.55]	.498 [12.65]	4	5-147396-4	5-147030-2
6	2.390 [60.71]	.598 [15.19]	4	5-147396-5	5-147030-5
7	1.400 [35.56]	.698 [17.73]	2	5-147396-6	5-147030-6
8	1.600 [40.64]	.798 [20.27]	2	5-147396-7	5-147030-7
9	1.800 [45.72]	.898 [22.81]	2	5-147396-8	5-147030-8
10	2.000 [50.80]	.998 [23.35]	2	5-147396-9	5-147030-9
11	2.200 [55.88]	1.098 [27.89]	2	6-147396-0	6-147030-0
12	2.400 [60.96]	1.198 [30.43]	2	6-147396-1	6-147030-1

**Note:** All part numbers are RoHS compliant.

## MTE Pin Assemblies, Shrouded—Polarized/Latching, Single-Row, .100 [2.54] Centerline

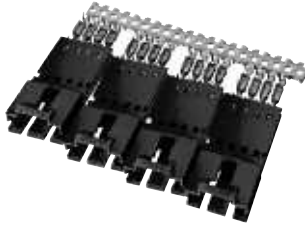

Preassembled housings in strip form are available in positions 2 thru 12. For ease of handling, positions 2 thru 5 are recommended when using the TE Manual Pistol Grip Tool.

### Material and Finish

**Housing** — Black thermoplastic, 94V-0 rated

**Contacts** — Phosphor Bronze, plated as follows:

**Plating A** — Duplex plated .000030 [0.00076] gold on contact area, .000050 [0.00127] min. tin in crimp area, with entire contact underplated .000050 [0.00127] nickel

**Plating B** — Duplex plated .000015 [0.00038] gold on contact area, .000050 [0.00127] min. tin in crimp area, with entire contact underplated .000050 [0.00127] nickel

**Plating C** — .000100 [0.00254] tin over .000050 [0.00127] nickel on entire contact

**Note:** Insulation displacement contacts accept an insulation diameter of .030 [0.76] min. to .054 [1.37] max. with an insulation wall thickness of .015 [0.38] max.

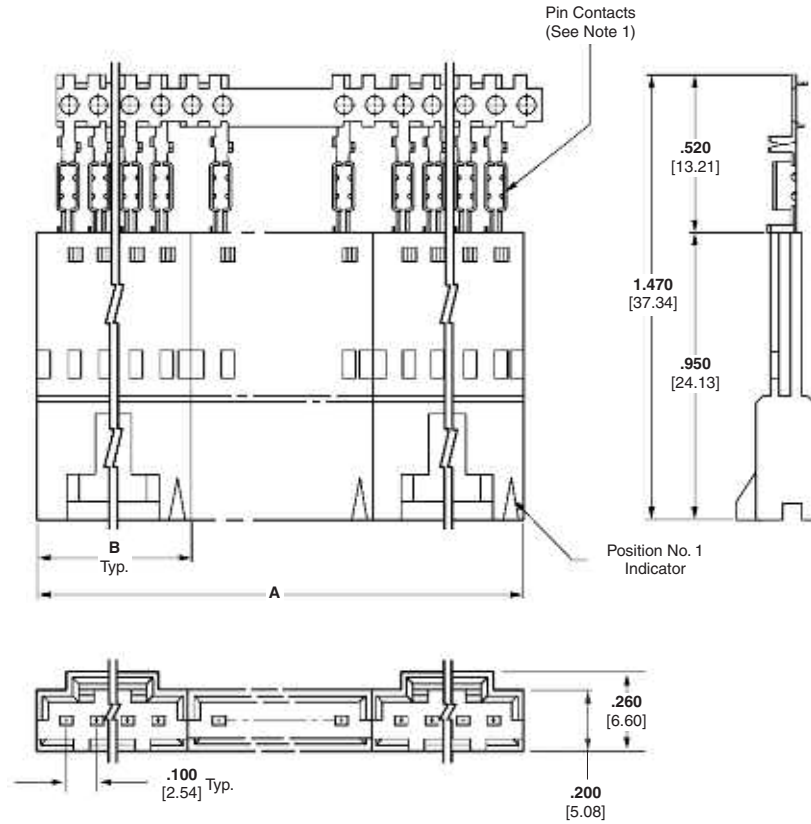

### Related Product Data

**Mateable AMPMODU Products** —

**Receptacle Assemblies (Polarized/Latching)** — pages 230, 231

**Receptacle Assemblies with Guide Ribs (installed in Single-Row Coupling Shroud)** — pages 232, 233, 235, 240

**Interchangeable Crimp Contacts** — page 254

**Application Tooling** — page 273

**Performance Specifications** — page 225

**Technical Documents** — pages 277, 278

**Product Specification**  
108-25034

**Application Specification**  
114-25026

**MTE Pin Assemblies, Shrouded—Strip Form Polarized/Latching, Single-Row, .100 [2.54] Centerline** (Continued)

No. of Pos.	Dimensions		Housing Quantities Per Strip Segment	Strip Form Pin Assembly 30-26 AWG [0.05-0.15mm <sup>2</sup> ] Wire			Strip Form Pin Assembly 26-22 AWG [0.12-0.3mm <sup>2</sup> ] Wire			Unloaded Housings
	A	B		Plating A	Plating B	Plating C	Plating A	Plating B	Plating C	
2	2.360 [59.94]	.295 [7.49]	8	5-103949-1	5-103948-1	5-103947-1	5-103946-1	5-103945-1	5-103944-1	103653-1
3	1.980 [50.29]	.395 [10.03]	5	5-103949-2	5-103948-2	5-103947-2	5-103946-2	5-103945-2	5-103944-2	103653-2
4	1.980 [50.29]	.495 [12.57]	4	5-103949-3	5-103948-3	5-103947-3	5-103946-3	5-103945-3	5-103944-3	103653-3
5	2.380 [60.45]	.595 [15.11]	4	5-103949-4	5-103948-4	5-103947-4	5-103946-4	5-103945-4	5-103944-4	103653-4
6	1.390 [35.31]	.695 [17.65]	2	5-103949-5	5-103948-5	5-103947-5	5-103946-5	5-103945-5	5-103944-5	103653-5
7	2.390 [60.71]	.795 [20.19]	3	5-103949-6	5-103948-6	5-103947-6	5-103946-6	5-103945-6	5-103944-6	103653-6
8	1.790 [45.47]	.895 [22.73]	2	5-103949-7	5-103948-7	5-103947-7	5-103946-7	5-103945-7	5-103944-7	103653-7
9	1.990 [50.57]	.995 [25.27]	2	5-103949-8	5-103948-8	5-103947-8	5-103946-8	5-103945-8	5-103944-8	103653-8
10	2.190 [55.63]	1.095 [27.81]	2	5-103949-9	5-103948-9	5-103947-9	5-103946-9	5-103945-9	5-103944-9	103653-9
11	2.390 [60.71]	1.195 [30.35]	2	6-103949-0	6-103948-0	6-103947-0	6-103946-0	6-103945-0	6-103944-0	1-103653-0
12	2.590 [65.79]	1.295 [32.89]	2	6-103949-1	6-103948-1	6-103947-1	6-103946-1	6-103945-1	6-103944-1	1-103653-1

**MTE Pin Assemblies, Shrouded—Individual Form Polarized/Latching, Single-Row, .100 [2.54] Centerline**

No. of Pos.	Dimensions B	Individual Pin Assembly 30-26 AWG [0.05-0.15mm <sup>2</sup> ] Wire			Individual Pin Assembly 26-22 AWG [0.12-0.3mm <sup>2</sup> ] Wire			Unloaded Housings
		Plating A	Plating B	Plating C	Plating A	Plating B	Plating C	
13	1.395 [35.43]	6-103894-2	6-103658-2	6-103659-2	6-103893-2	6-103660-2	6-103661-2	1-103653-2
14	1.495 [37.97]	6-103894-3	6-103658-3	6-103659-3	6-103893-3	6-103660-3	6-103661-3	1-103653-3
15	1.595 [40.51]	6-103894-4	6-103658-4	6-103659-4	6-103893-4	6-103660-4	6-103661-4	1-103653-4
16	1.695 [43.05]	6-103894-5	6-103658-5	6-103659-5	6-103893-5	6-103660-5	6-103661-5	1-103653-5
17	1.795 [45.59]	6-103894-6	6-103658-6	6-103659-6	6-103893-6	6-103660-6	6-103661-6	1-103653-6
18	1.895 [48.13]	6-103894-7	6-103658-7	6-103659-7	6-103893-7	6-103660-7	6-103661-7	1-103653-7
19	1.995 [50.67]	6-103894-8	6-103658-8	6-103659-8	6-103893-8	6-103660-8	6-103661-8	1-103653-8
20	2.095 [53.21]	6-103894-9	6-103658-9	6-103659-9	6-103893-9	6-103660-9	6-103661-9	1-103653-9
21	2.195 [55.75]	7-103894-0	7-103658-0	7-103659-0	7-103893-0	7-103660-0	7-103661-0	2-103653-0
22	2.295 [58.29]	7-103894-1	7-103658-1	7-103659-1	7-103893-1	7-103660-1	7-103661-1	2-103653-1
23	2.395 [60.83]	7-103894-2	7-103658-2	7-103659-2	7-103893-2	7-103660-2	7-103661-2	2-103653-2
24	2.495 [63.37]	7-103894-3	7-103658-3	7-103659-3	7-103893-3	7-103660-3	7-103661-3	2-103653-3
25	2.595 [65.91]	7-103894-4	7-103658-4	7-103659-4	7-103893-4	7-103660-4	7-103661-4	2-103653-4

**Notes:** 1. Pin assemblies are furnished with strip contacts partially inserted into housing—contacts latched into “preload” windows. Contacts are fully inserted into housings automatically when terminated with TE application machines, or manually when terminated with TE pistol grip hand tool.  
 2. Use **Extraction/Lance Reset Tool No. 843477-1** to remove pin contacts.

**Note:** All part numbers are RoHS compliant.

## MTE Pin Assemblies—Guide Ribs, Single-Row, .100 [2.54] Centerline



Preassembled housings in strip form are available in positions 2 thru 12. For ease of handling, positions 2 thru 5 are recommended when using the TE Manual Pistol Grip Tool.

### Material and Finish

**Housing** — Black thermoplastic, 94V-0 rated

**Contacts** — Phosphor Bronze, plated as follows:

**Plating A** — Duplex plated .000030 [0.00076] gold on contact area, .000050 [0.00127] min. tin in crimp area, with entire contact underplated .000050 [0.00127] nickel

**Plating B** — Duplex plated .000015 [0.00038] gold on contact area, .000050 [0.00127] min. tin in crimp area, with entire contact underplated .000050 [0.00127] nickel

**Plating C** — .000100 [0.00254] tin over .000050 [0.00127] nickel on entire contact

**Note:** Insulation displacement contacts accept an insulation diameter of .030 [0.76] min. to .054 [1.37] max. with an insulation wall thickness of .015 [0.38] max.

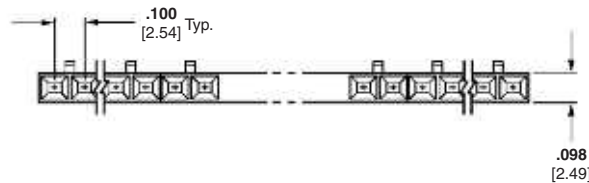
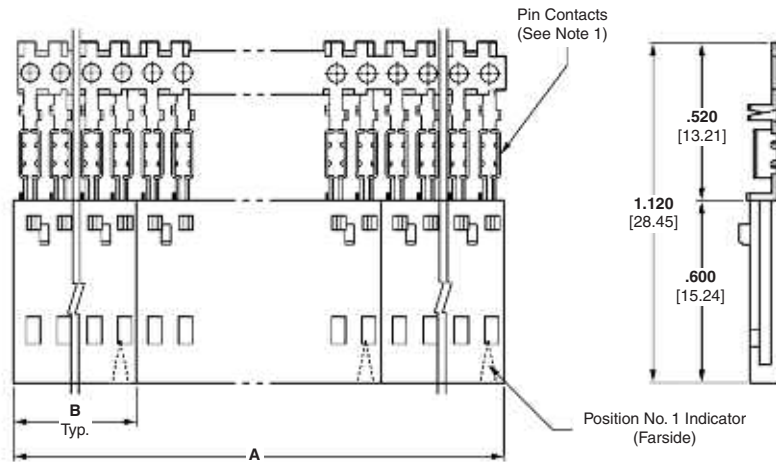

### Related Product Data

**Mateable AMPMODU MTE Products (with Pin Assembly Installed in Panel Mount Pin Shroud)** — pages 242, 243

**Receptacle Assemblies (Polarized/Latching)** — pages 230, 231

**Receptacle Assemblies with Guide Ribs (installed in Single Row Coupling Shroud)** — pages 232, 233, 235, 240

**Interchangeable Crimp Contacts** — page 254

**Application Tooling** — page 273

**Performance Specifications** — page 225

**Technical Documents** — pages 277, 278

**Product Specification**  
108-25034

**Application Specification**  
114-25026

### MTE Pin Assemblies—Strip Form with Guide Ribs, Single-Row, .100 [2.54] Centerline (Continued)

No. of Pos.	Dimensions		Housing Quantities Per Strip Segment	Strip Form Pin Assembly 30-26 AWG [0.05-0.15mm <sup>2</sup> ] Wire			Strip Form Pin Assembly 26-22 AWG [0.12-0.3mm <sup>2</sup> ] Wire			Unloaded Housings
	A	B		Plating A	Plating B	Plating C	Plating A	Plating B	Plating C	
2	1.980 [50.29]	0.198 [5.03]	10	5-103955-1	5-103954-1	5-103953-1	5-103952-1	5-103951-1	5-103950-1	104503-1
3	1.490 [37.85]	0.298 [7.57]	5	5-103955-2	5-103954-2	5-103953-2	5-103952-2	5-103951-2	5-103950-2	104503-2
4	1.990 [50.55]	0.398 [10.11]	5	5-103955-3	5-103954-3	5-103953-3	5-103952-3	5-103951-3	5-103950-3	104503-3
5	1.990 [50.55]	0.498 [12.65]	4	5-103955-4	5-103954-4	5-103953-4	5-103952-4	5-103951-4	5-103950-4	104503-4
6	2.390 [60.71]	0.598 [15.19]	4	5-103955-5	5-103954-5	5-103953-5	5-103952-5	5-103951-5	5-103950-5	104503-5
7	1.400 [35.56]	0.698 [17.73]	2	5-103955-6	5-103954-6	5-103953-6	5-103952-6	5-103951-6	5-103950-6	104503-6
8	1.600 [40.64]	0.798 [20.27]	2	5-103955-7	5-103954-7	5-103953-7	5-103952-7	5-103951-7	5-103950-7	104503-7
9	1.800 [45.72]	0.898 [22.81]	2	5-103955-8	5-103954-8	5-103953-8	5-103952-8	5-103951-8	5-103950-8	104503-8
10	2.000 [50.80]	0.998 [25.35]	2	5-103955-9	5-103954-9	5-103953-9	5-103952-9	5-103951-9	5-103950-9	104503-9
11	2.200 [55.88]	1.098 [27.89]	2	6-103955-0	6-103954-0	6-103953-0	6-103952-0	6-103951-0	6-103950-0	1-104503-0
12	2.400 [60.96]	1.198 [30.43]	2	6-103955-1	6-103954-1	6-103953-1	6-103952-1	6-103951-1	6-103950-1	1-104503-1

### MTE Pin Assemblies—Individual Form with Guide Ribs, Single-Row, .100 [2.54] Centerline

No. of Pos.	Dimensions B	Individual Pin Assembly 30-26 AWG [0.05-0.15mm <sup>2</sup> ] Wire			Individual Pin Assembly 26-22 AWG [0.12-0.3mm <sup>2</sup> ] Wire			Unloaded Housings
		Plating A	Plating B	Plating C	Plating A	Plating B	Plating C	
13	1.398 [35.51]	6-103896-2	6-103657-2	6-103656-2	6-103895-2	6-103655-2	6-103654-2	1-104503-2
14	1.498 [38.05]	6-103896-3	6-103657-3	6-103656-3	6-103895-3	6-103655-3	6-103654-3	1-104503-3
15	1.598 [40.59]	6-103896-4	6-103657-4	6-103656-4	6-103895-4	6-103655-4	6-103654-4	1-104503-4
16	1.698 [43.13]	6-103896-5	6-103657-5	6-103656-5	6-103895-5	6-103655-5	6-103654-5	1-104503-5
17	1.798 [45.67]	6-103896-6	6-103657-6	6-103656-6	6-103895-6	6-103655-6	6-103654-6	1-104503-6
18	1.898 [48.20]	6-103896-7	6-103657-7	6-103656-7	6-103895-7	6-103655-7	6-103654-7	1-104503-7
19	1.998 [50.75]	6-103896-8	6-103657-8	6-103656-8	6-103895-8	6-103655-8	6-103654-8	1-104503-8
20	2.098 [53.29]	6-103896-9	6-103657-9	6-103656-9	6-103895-9	6-103655-9	6-103654-9	1-104503-9
21	2.198 [55.83]	7-103896-0	7-103657-0	7-103656-0	7-103895-0	7-103655-0	7-103654-0	2-104503-0
22	2.298 [58.37]	7-103896-1	7-103657-1	7-103656-1	7-103895-1	7-103655-1	7-103654-1	2-104503-1
23	2.398 [60.91]	7-103896-2	7-103657-2	7-103656-2	7-103895-2	7-103655-2	7-103654-2	2-104503-2
24	2.498 [63.45]	7-103896-3	7-103657-3	7-103656-3	7-103895-3	7-103655-3	7-103654-3	2-104503-3
25	2.598 [65.99]	7-103896-4	7-103657-4	7-103656-4	7-103895-4	7-103655-4	7-103654-4	2-104503-4

- Notes:** 1. Pin assemblies are furnished with strip contacts partially inserted into housing—contacts latched into “preload” windows. Contacts are fully inserted into housings automatically when terminated with TE application machines, or manually when terminated with TE pistol grip hand tool.  
 2. Use **Extraction/Lance Reset Tool No. 843477-1** to remove pin contacts.

**Note:** All part numbers are RoHS compliant.

## Coupling Shrouds for MTE Receptacle Assemblies with Guide Ribs

### Single-Row

#### Material

Black thermoplastic, 94V-0 rated

**Technical Documents** —  
pages 277, 278

**Product Specification**  
108-25034

**Application Specification**  
114-25026

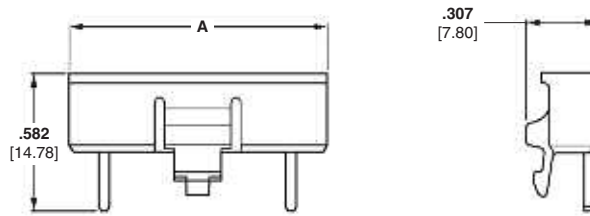

No. of Pos.	Dimension A	Single-Row Coupling Shroud
4	.485 [12.32]	103680-1
5	.585 [14.86]	103680-2
6	.685 [17.40]	103680-3
7	.785 [19.94]	103680-4
8	.885 [22.48]	103680-5
9	.985 [25.02]	103680-6
10	1.085 [27.56]	103680-7
11	1.185 [30.10]	103680-8
12	1.285 [32.64]	103680-9
13	1.385 [35.18]	1-103680-0
14	1.485 [37.72]	1-103680-1

No. of Pos.	Dimension A	Single-Row Coupling Shroud
15	1.585 [40.26]	1-103680-2
16	1.685 [42.80]	1-103680-3
17	1.785 [45.34]	1-103680-4
18	1.885 [47.88]	1-103680-5
19	1.985 [50.42]	1-103680-6
20	2.085 [52.96]	1-103680-7
21	2.185 [55.50]	1-103680-8
22	2.285 [58.04]	1-103680-9
23	2.385 [60.58]	2-103680-0
24	2.485 [63.12]	2-103680-1
25	2.585 [65.66]	2-103680-2

MTE Coupling Shrouds

5

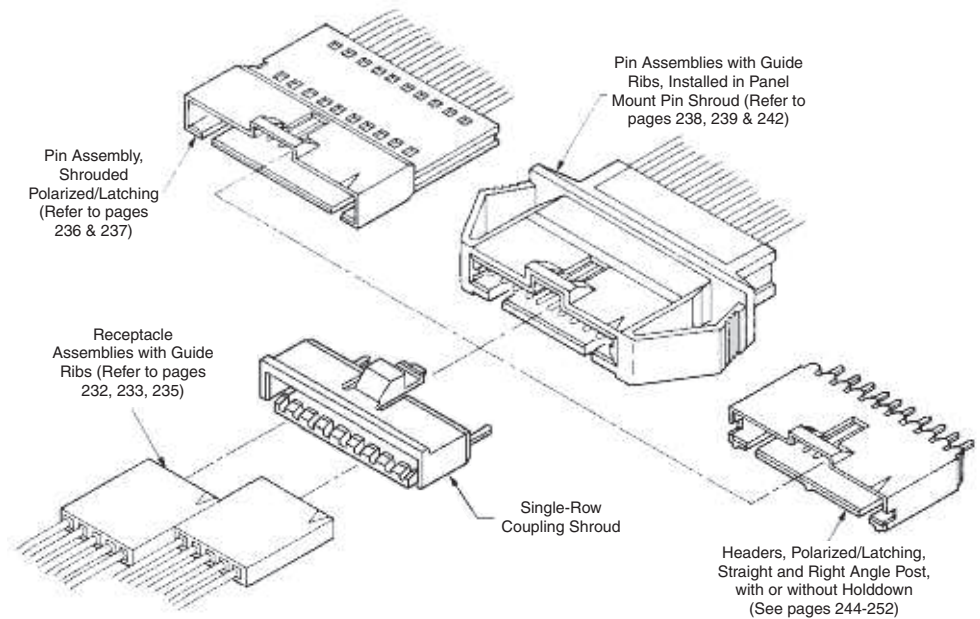

**Typical Application of Single-Row Coupling Shroud and Mating AMPMODU MTE Products**

**Note:** All part numbers are RoHS compliant.



**Coupling Shrouds for MTE Receptacle Assemblies with Guide Ribs** (Continued)

**Double-Row**

**Material**

Black thermoplastic, 94V-0 rated

**Technical Documents** —  
pages 277, 278

**Product Specification**  
108-25034

**Application Specification**  
114-25026

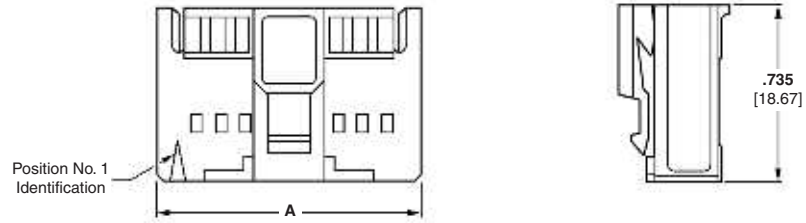

No. of Pos.	Dimension A	Double-Row Coupling Shroud
8	.585 [14.86]	103681-1
10	.685 [17.40]	103681-2
12	.785 [19.94]	103681-3
14	.885 [22.48]	103681-4
16	.985 [25.02]	103681-5
18	1.085 [27.56]	104500-1
20	1.185 [30.10]	104500-2
22	1.285 [32.64]	104500-3
24	1.385 [35.18]	104500-4
26	1.485 [37.72]	104500-5
28	1.585 [40.26]	104500-6
30	1.685 [42.80]	104500-7
32	1.785 [45.34]	104500-8
34	1.885 [47.88]	104500-9
40	2.185 [55.50]	1-104500-0
50	2.685 [68.20]	1-104500-1

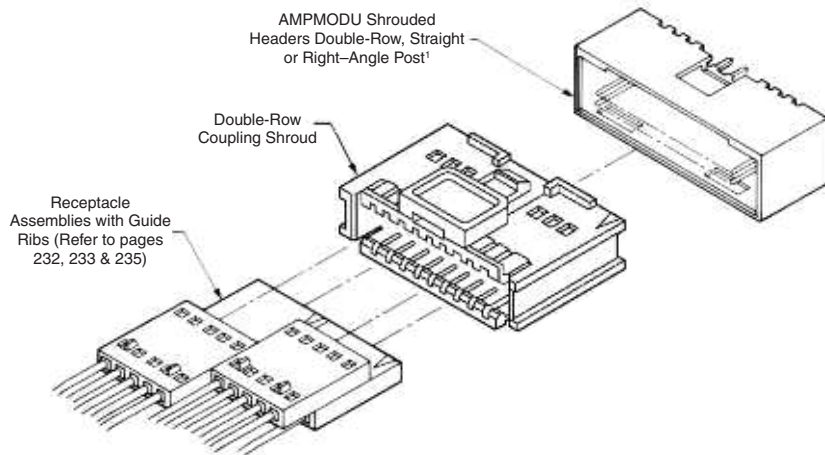

¹Mating AMPMODU Double-Row Shrouded Headers must have .318 [8.08] mating post length and .150 [3.81] dimension from centerline of last post to inside of end shroud wall.

**Typical Application of Double-Row Coupling Shroud and Mating AMPMODU Products**

**Note:** All part numbers are RoHS compliant.

## Panel Mount Pin Shrouds for MTE Pin Assemblies with Guide Ribs, Single-Row

### Material

Black thermoplastic, 94V-0 rated

**Technical Documents** —  
pages 277, 278

**Product Specification**  
108-25034

**Application Specification**  
114-25026

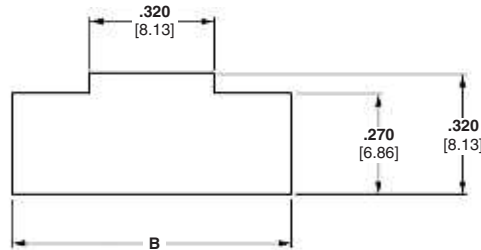
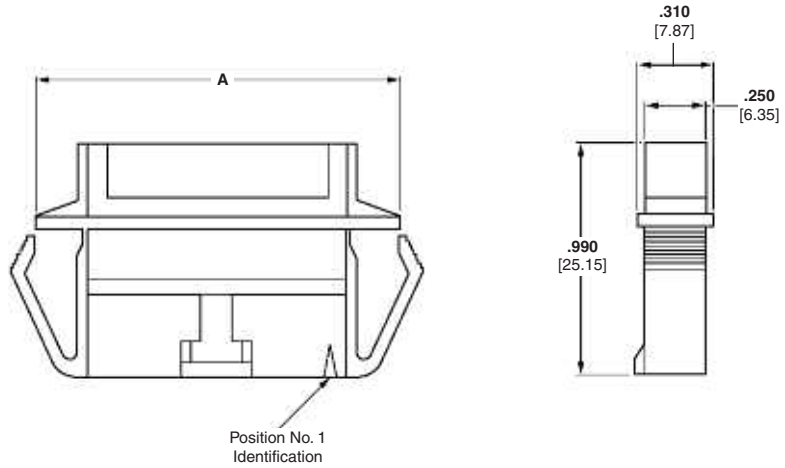

No. of Pos.	Dimensions		Panel Mount Pin Shroud
	A	B	
2	.735 [18.67]	.625 [15.88]	103682-1
3	.835 [21.21]	.725 [18.42]	103682-2
4	.935 [23.75]	.825 [20.96]	103682-3
5	1.035 [26.29]	.925 [23.50]	103682-4
6	1.135 [28.83]	1.025 [26.04]	103682-5
7	1.235 [31.37]	1.125 [28.58]	103682-6
8	1.335 [33.91]	1.225 [31.12]	103682-7
9	1.435 [36.45]	1.325 [33.66]	103682-8
10	1.535 [38.99]	1.425 [36.20]	103682-9
11	1.635 [41.53]	1.525 [38.74]	1-103682-0
12	1.735 [44.07]	1.625 [41.28]	1-103682-1
13	1.835 [46.61]	1.725 [43.82]	1-103682-2

No. of Pos.	Dimensions		Panel Mount Pin Shroud
	A	B	
14	1.935 [49.15]	1.825 [46.36]	1-103682-3
15	2.035 [51.69]	1.925 [48.90]	1-103682-4
16	2.135 [54.23]	2.025 [51.44]	1-103682-5
17	2.235 [56.77]	2.125 [53.98]	1-103682-6
18	2.335 [59.31]	2.225 [56.52]	1-103682-7
19	2.435 [61.85]	2.325 [59.06]	1-103682-8
20	2.535 [64.39]	2.425 [61.60]	1-103682-9
21	2.635 [66.93]	2.525 [64.14]	2-103682-0
22	2.735 [69.47]	2.625 [66.68]	2-103682-1
23	2.835 [72.01]	2.725 [69.22]	2-103682-2
24	2.935 [74.55]	2.825 [71.76]	2-103682-3
25	3.035 [77.09]	2.925 [74.30]	2-103682-4

**Note:** All part numbers are RoHS compliant.

## Panel Mount Pin Shrouds for MTE Pin Assemblies with Guide Ribs, Single-Row (Continued)

### Material

Black thermoplastic, 94V-0 rated

**Technical Documents** —  
pages 277, 278

**Product Specification**  
108-25034

**Application Specification**  
114-25026

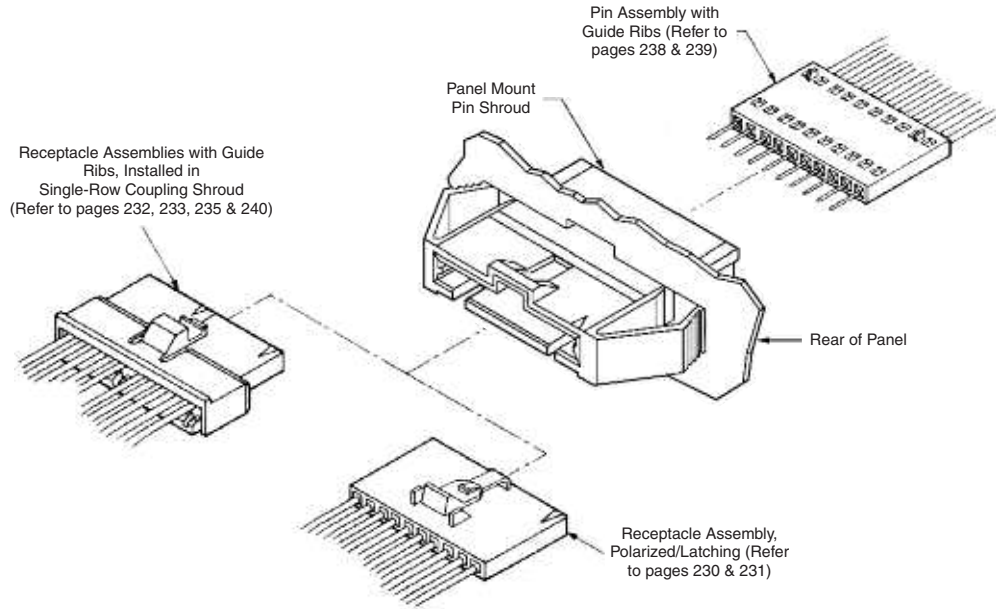

Typical Application of Panel Mount Pin Shroud and Mating AMPMODU Products

## MTE Headers, Shrouded Polarized/Latching, Single-Row .100 [2.54] Centerline

**.025 [0.64] Square Straight Post (With or Without Swaged Tail)**

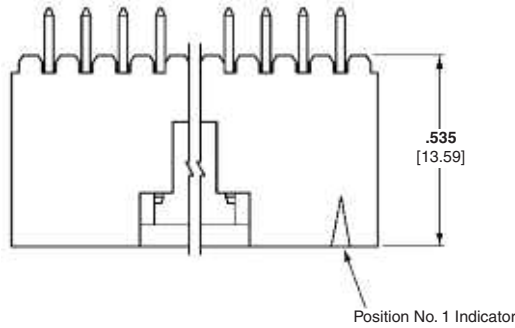

Swaged Retention Tail (See Note)

### Material and Finish

**Housing** — Black thermoplastic, 94V-0 rated

**Posts** — Brass, plated as follows:

**Plating A** — Duplex plated .000030 [0.00076] gold on contact area, .000100 [0.00254] min. tin on solder area, with entire post underplated .000050 [0.00127] nickel

**Plating B** — Duplex plated .000015 [0.00038] gold on contact area, .000100 [0.00254] min. tin on solder area, with entire post underplated .000050 [0.00127] nickel

**Plating C** — .000100 [0.00254] tin over .000050 [0.00127] nickel on entire post

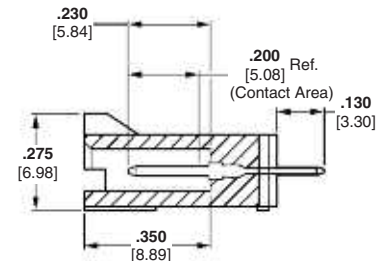
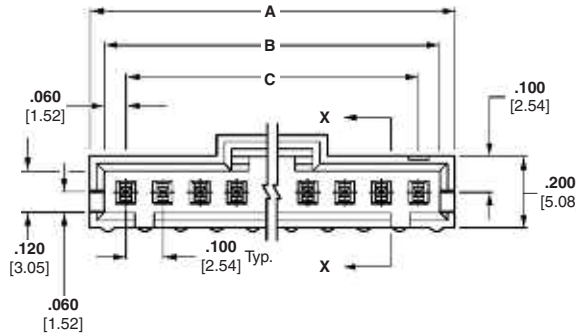

Section X-X

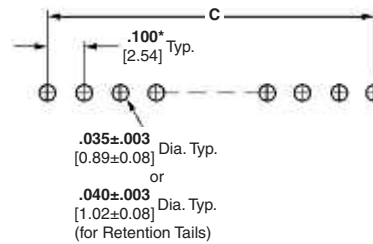

Recommended PC Board Hole Layout

\*±.003 [±0.08]; tolerances not to accumulate within one connector pattern.

**Note:** Swaged retention tails are provided in a minimum of two locations per header.

### Related Product Data

**Mateable AMPMODU MTE Products** —

**Receptacle Assemblies (Polarized/Latching)** — pages 230, 231

**Receptacle Assemblies with Guide Ribs (installed in Single-Row Coupling Shroud)** — pages 232, 233, 235, 240

**Technical Documents** — pages 277, 278

**Product Specification**  
108-25034

**Application Specification**  
114-25026

**MTE Headers, Shrouded Polarized/Latching,  
Single-Row .100 [2.54] Centerline** (Continued)

No. of Pos.	Dimensions			Polarized/Latching Header With Swage			Polarized/Latching Header Without Swage		
	A	B	C	Plating A	Plating B	Plating C	Plating A	Plating B	Plating C
2	.300 [7.62]	.220 [5.59]	.100 [2.54]	5-103908-1	5-104362-1	5-103669-1	5-103735-1	5-104363-1	5-103639-1
3	.400 [10.16]	.320 [8.13]	.200 [5.08]	5-103908-2	5-104362-2	5-103669-2	5-103735-2	5-104363-2	5-103639-2
4	.500 [12.70]	.420 [10.67]	.300 [7.62]	5-103908-3	5-104362-3	5-103669-3	5-103735-3	5-104363-3	5-103639-3
5	.600 [15.24]	.520 [13.21]	.400 [10.16]	5-103908-4	5-104362-4	5-103669-4	5-103735-4	5-104363-4	5-103639-4
6	.700 [17.78]	.620 [15.75]	.500 [12.70]	5-103908-5	5-104362-5	5-103669-5	5-103735-5	5-104363-5	5-103639-5
7	.800 [20.32]	.720 [18.29]	.600 [15.24]	5-103908-6	5-104362-6	5-103669-6	5-103735-6	5-104363-6	5-103639-6
8	.900 [22.86]	.820 [20.83]	.700 [17.78]	5-103908-7	5-104362-7	5-103669-7	5-103735-7	5-104363-7	5-103639-7
9	1.000 [25.40]	.920 [23.37]	.800 [20.32]	5-103908-8	5-104362-8	5-103669-8	5-103735-8	5-104363-8	5-103639-8
10	1.100 [27.94]	1.020 [25.91]	.900 [22.86]	5-103908-9	5-104362-9	5-103669-9	5-103735-9	5-104363-9	5-103639-9
11	1.200 [30.48]	1.120 [28.45]	1.000 [25.40]	6-103908-0	6-104362-0	6-103669-0	6-103735-0	6-104363-0	6-103639-0
12	1.300 [33.02]	1.220 [30.99]	1.100 [27.94]	6-103908-1	6-104362-1	6-103669-1	6-103735-1	6-104363-1	6-103639-1
13	1.400 [35.56]	1.320 [33.53]	1.200 [30.48]	6-103908-2	6-104909-2	6-103669-2	6-103735-2	6-104910-2	6-103639-2
14	1.500 [38.10]	1.420 [36.07]	1.300 [33.02]	6-103908-3	6-104909-3	6-103669-3	6-103735-3	6-104910-3	6-103639-3
15	1.600 [40.64]	1.520 [38.61]	1.400 [35.56]	6-103908-4	6-104909-4	6-103669-4	6-103735-4	6-104910-4	6-103639-4
16	1.700 [43.18]	1.620 [41.15]	1.500 [38.10]	6-103908-5	6-104909-5	6-103669-5	6-103735-5	6-104910-5	6-103639-5
17	1.800 [45.72]	1.720 [43.69]	1.600 [40.64]	6-103908-6	6-104909-6	6-103669-6	6-103735-6	6-104910-6	6-103639-6
18	1.900 [48.26]	1.820 [46.23]	1.700 [43.18]	6-103908-7	6-104909-7	6-103669-7	6-103735-7	6-104910-7	6-103639-7
19	2.000 [50.80]	1.920 [48.77]	1.800 [45.72]	6-103908-8	6-104909-8	6-103669-8	6-103735-8	6-104910-8	6-103639-8
20	2.100 [53.34]	2.020 [51.31]	1.900 [48.26]	6-103908-9	6-104909-9	6-103669-9	6-103735-9	6-104910-9	6-103639-9
21	2.200 [55.88]	2.120 [53.85]	2.000 [50.80]	7-103908-0	7-104909-0	7-103669-0	7-103735-0	7-104910-0	7-103639-0
22	2.300 [58.42]	2.220 [56.39]	2.100 [53.34]	7-103908-1	7-104909-1	7-103669-1	7-103735-1	7-104910-1	7-103639-1
23	2.400 [60.96]	2.320 [58.93]	2.200 [55.88]	7-103908-2	7-104909-2	7-103669-2	7-103735-2	7-104910-2	7-103639-2
24	2.500 [63.50]	2.420 [61.47]	2.300 [58.42]	7-103908-3	7-104909-3	7-103669-3	7-103735-3	7-104910-3	7-103639-3
25	2.600 [66.04]	2.520 [64.01]	2.400 [60.96]	7-103908-4	7-104909-4	7-103669-4	7-103735-4	7-104910-4	7-103639-4

Notes: 1. Selectively loaded headers are available, consult TE.  
2. Use Keying Tool No. 91417-1 to remove post for keying.

Note: All part numbers are RoHS compliant.

## MTE Headers, Shrouded Latching, Single-Row .100 [2.54] Centerline

### .025 [0.64] Square Right-Angle Post



#### Material and Finish

**Housing** — Black thermoplastic, 94V-0 rated

**Posts** — Brass, plated as follows:

**Plating A** — Duplex plated .000030 [0.00076] gold on contact area, .000100 [0.00254] min. tin on solder area, with entire post underplated .000050 [0.00127] nickel

**Plating B** — Duplex plated .000015 [0.00038] gold on contact area, .000100 [0.00254] min. tin on solder area, with entire post underplated .000050 [0.00127] nickel

**Plating C** — .000100 [0.00254] tin over .000050 [0.00127] nickel on entire post

### With Holddown

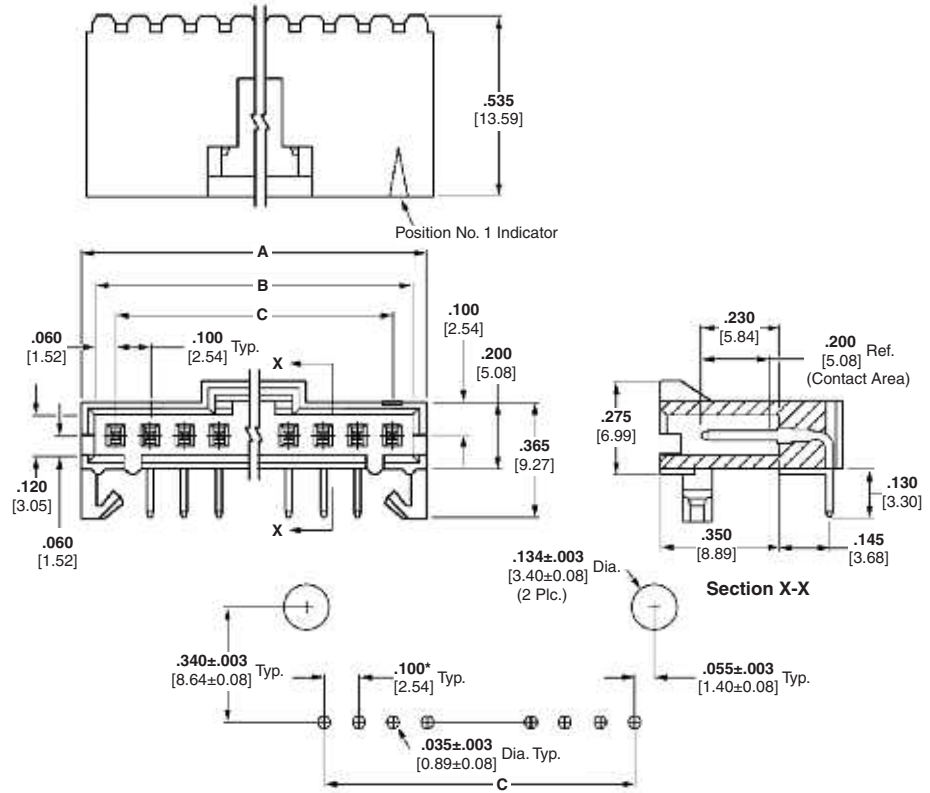

**Recommended PC Board Hole Layout**  
(PC board thickness (for Holddown Feature) is .062±.008 [1.57±0.20])  
\*±.003 [±0.08]; tolerance not to accumulate within one connector pattern.

### Without Holddown

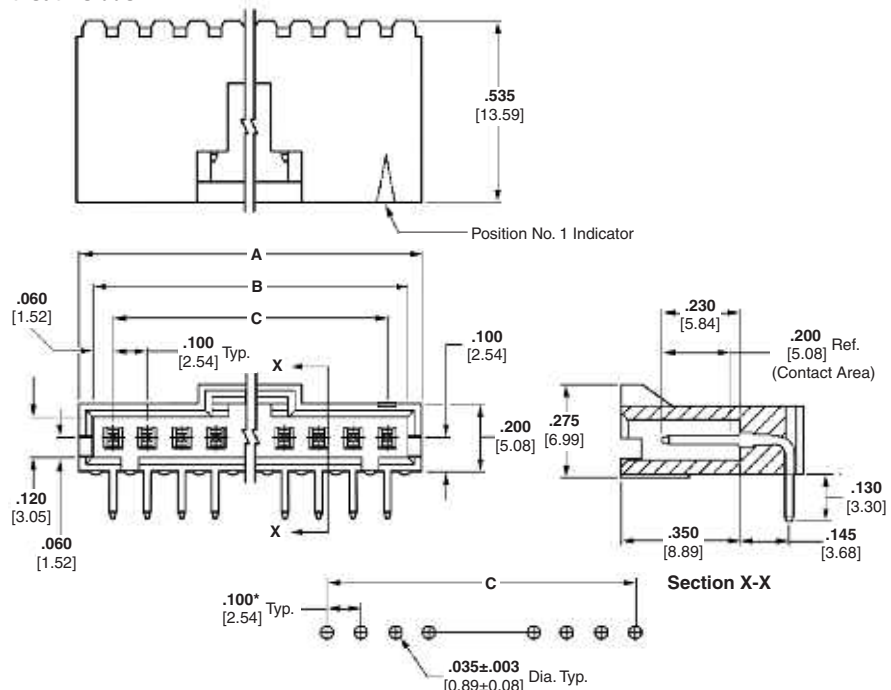

**Recommended PC Board Hole Layout**  
\*±.003 [±0.08]; tolerance not to accumulate within one connector pattern.

#### Related Product Data

**Mateable AMPMODU MTE Products** —

**Receptacle Assemblies (Latching)** — pages 230, 231  
**Receptacle Assemblies with Guide Ribs (installed in Single-Row Coupling Shroud)** — pages 232, 233, 235, 240

**Technical Documents** — pages 277, 278

**Product Specification**  
108-25034

**Application Specification**  
114-25026

**MTE Headers, Shrouded Latching, Single-Row .100 [2.54] Centerline** (Continued)

No. of Pos.	Dimensions			Latching Header With Hold Down			Latching Header Without Hold Down		
	A	B	C	Plating A	Plating B	Plating C	Plating A	Plating B	Plating C
2	.300 [7.62]	.220 [5.59]	.100 [2.54]	5-103904-1	5-103673-1	5-103672-1	5-104935-5	5-103635-1	5-103634-1
3	.400 [10.16]	.320 [8.13]	.200 [5.08]	5-103904-2	5-103673-2	5-103672-2	5-104935-3	5-103635-2	5-103634-2
4	.500 [12.70]	.420 [10.67]	.300 [7.62]	5-103904-3	5-103673-3	5-103672-3	5-104935-1	5-103635-3	5-103634-3
5	.600 [15.24]	.520 [13.21]	.400 [10.16]	5-103904-4	5-103673-4	5-103672-4	5-104935-6	5-103635-4	5-103634-4
6	.700 [17.78]	.620 [15.75]	.500 [12.70]	5-103904-5	5-103673-5	5-103672-5	5-104935-7	5-103635-5	5-103634-5
7	.800 [20.32]	.720 [18.29]	.600 [15.24]	5-103904-6	5-103673-6	5-103672-6	5-104935-8	5-103635-6	5-103634-6
8	.900 [22.86]	.820 [20.83]	.700 [17.78]	5-103904-7	5-103673-7	5-103672-7	5-104935-2	5-103635-7	5-103634-7
9	1.000 [25.40]	.920 [23.37]	.800 [20.32]	5-103904-8	5-103673-8	5-103672-8	5-104935-9	5-103635-8	5-103634-8
10	1.100 [27.94]	1.020 [25.91]	.900 [22.86]	5-103904-9	5-103673-9	5-103672-9	6-104935-0	5-103635-9	5-103634-9
11	1.200 [30.48]	1.120 [28.45]	1.000 [25.40]	6-103904-0	6-103673-0	6-103672-0	6-104935-1	6-103635-0	6-103634-0
12	1.300 [33.02]	1.220 [30.99]	1.100 [27.94]	6-103904-1	6-103673-1	6-103672-1	5-104935-4	6-103635-1	6-103634-1
13	1.400 [35.56]	1.320 [33.53]	1.200 [30.48]	6-103904-2	6-103673-2	6-103672-2	6-104935-2	6-103635-2	6-103634-2
14	1.500 [38.10]	1.420 [36.07]	1.300 [33.02]	6-103904-3	6-103673-3	6-103672-3	6-104935-3	6-103635-3	6-103634-3
15	1.600 [40.64]	1.520 [38.61]	1.400 [35.56]	6-103904-4	6-103673-4	6-103672-4	6-104935-4	6-103635-4	6-103634-4
16	1.700 [43.18]	1.620 [41.15]	1.500 [38.10]	6-103904-5	6-103673-5	6-103672-5	6-104935-5	6-103635-5	6-103634-5
17	1.800 [45.72]	1.720 [43.69]	1.600 [40.64]	6-103904-6	6-103673-6	6-103672-6	6-104935-6	6-103635-6	6-103634-6
18	1.900 [48.26]	1.820 [46.23]	1.700 [43.18]	6-103904-7	6-103673-7	6-103672-7	6-104935-7	6-103635-7	6-103634-7
19	2.000 [50.80]	1.920 [48.77]	1.800 [45.72]	6-103904-8	6-103673-8	6-103672-8	6-104935-8	6-103635-8	6-103634-8
20	2.100 [53.34]	2.020 [51.31]	1.900 [48.26]	6-103904-9	6-103673-9	6-103672-9	6-104935-9	6-103635-9	6-103634-9
21	2.200 [55.88]	2.120 [53.85]	2.000 [50.80]	7-103904-0	7-103673-0	7-103672-0	7-104935-0	7-103635-0	7-103634-0
22	2.300 [58.42]	2.220 [56.39]	2.100 [53.34]	7-103904-1	7-103673-1	7-103672-1	7-104935-1	7-103635-1	7-103634-1
23	2.400 [60.96]	2.320 [58.93]	2.200 [55.88]	7-103904-2	7-103673-2	7-103672-2	7-104935-2	7-103635-2	7-103634-2
24	2.500 [63.50]	2.420 [61.47]	2.300 [58.42]	7-103904-3	7-103673-3	7-103672-3	7-104935-3	7-103635-3	7-103634-3
25	2.600 [66.04]	2.520 [64.01]	2.400 [60.96]	7-103904-4	7-103673-4	7-103672-4	7-104935-4	7-103635-4	7-103634-4

Notes: 1. Selectively loaded headers are available, consult TE.  
 2. Use Keying Tool No. 91417-1 to remove post for keying.

Note: All part numbers are RoHS compliant.

## MTE Headers, Shrouded Latching, Single-Row .100 [2.54] Centerline

### .025 [0.64] Square Straight Post (With Swaged Tails and PC Board Orientation)

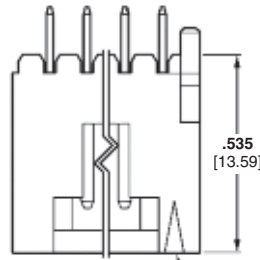

Swaged Retention Tail (See Note)

Position No. 1 Indicator

#### Material and Finish

**Housing** — Black thermoplastic, 94V-0 rated

**Posts** — Brass, plated .000100 [0.00254] tin over .000050 [0.00127] nickel on entire post

#### Related Product Data

**Mateable AMPMODU MTE Products** —

**Receptacle Assemblies (Polarized/Latching)** — pages 230, 231

**Receptacle Assemblies with Guide Ribs (installed in Single-Row Coupling Shroud)** — pages 232, 233, 235, 240

**Technical Documents** — pages 277, 278

**Product Specification** 108-25034

**Application Specification** 114-25026

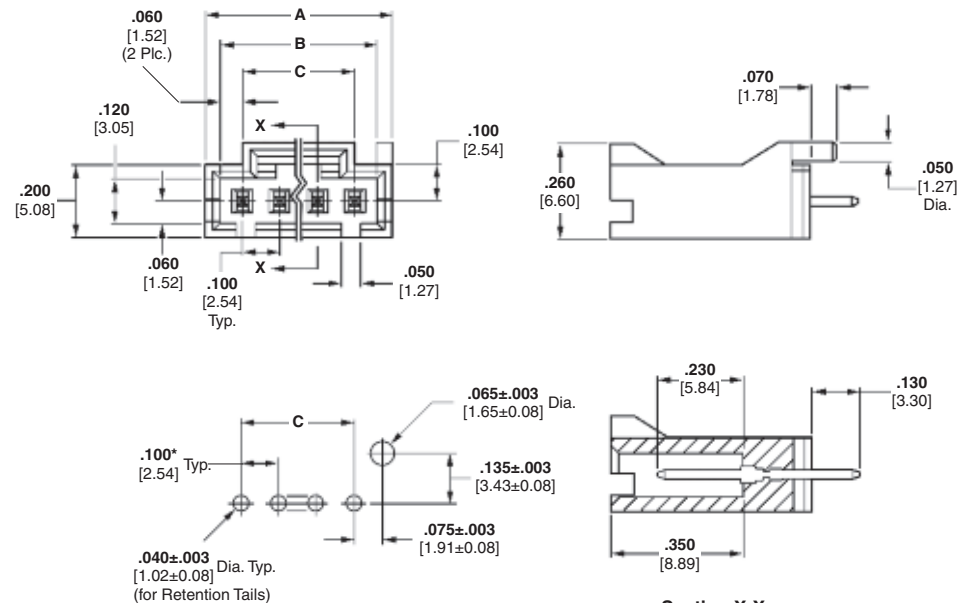

Recommended PC Board Hole Layout

\*±.003 [±0.08]; tolerances not to accumulate within one connector pattern.

**Note:** Swaged retention tails are provided in a minimum of two locations per header.

No. of Pos.	Dimensions			Latching Header
	A	B	C	
2	.300 [7.62]	.220 [5.59]	.100 [2.54]	5-104450-1
3	.400 [10.16]	.320 [8.13]	.200 [5.08]	5-104450-2
4	.500 [12.70]	.420 [10.67]	.300 [7.62]	5-104450-3
5	.600 [15.24]	.520 [13.21]	.400 [10.16]	5-104450-4
6	.700 [17.78]	.620 [15.75]	.500 [12.70]	5-104450-5
7	.800 [20.32]	.720 [18.29]	.600 [15.24]	5-104450-6
8	.900 [22.86]	.820 [20.83]	.700 [17.78]	5-104450-7
9	1.000 [25.40]	.920 [23.37]	.800 [20.32]	5-104450-8
10	1.100 [27.94]	1.020 [25.91]	.900 [22.86]	5-104450-9

**Note:** All part numbers are RoHS compliant.



## MTE Headers, Through-hole, Surface Mount Compatible, Shrouded Polarized/Latching, Single-Row .100 [2.54] Centerline

**.025 [0.64] Square Straight Post (With Swaged Tails and PC Board Orientation)**



**Material and Finish**

**Housing** — Black thermoplastic, 94V-0 rated

**Posts** — Brass, duplex plated .000015 [0.00038] gold on contact area, .000100 [0.00254] min tin on solder tail, with entire post underplated .000050 [0.00127] nickel

**Related Product Data**

**Mateable AMPMODU MTE Products** —

**Receptacle Assemblies with Guide Ribs (installed in Single-Row Coupling Shroud)** — pages 232, 233, 235, 240

**Receptacle Assemblies (Polarized Latching)** — pages 230, 231

**Technical Documents** — pages 277, 278

**Product Specification** 108-25034

**Application Specification** 114-25026

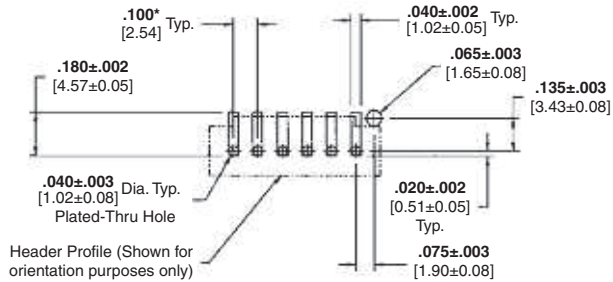
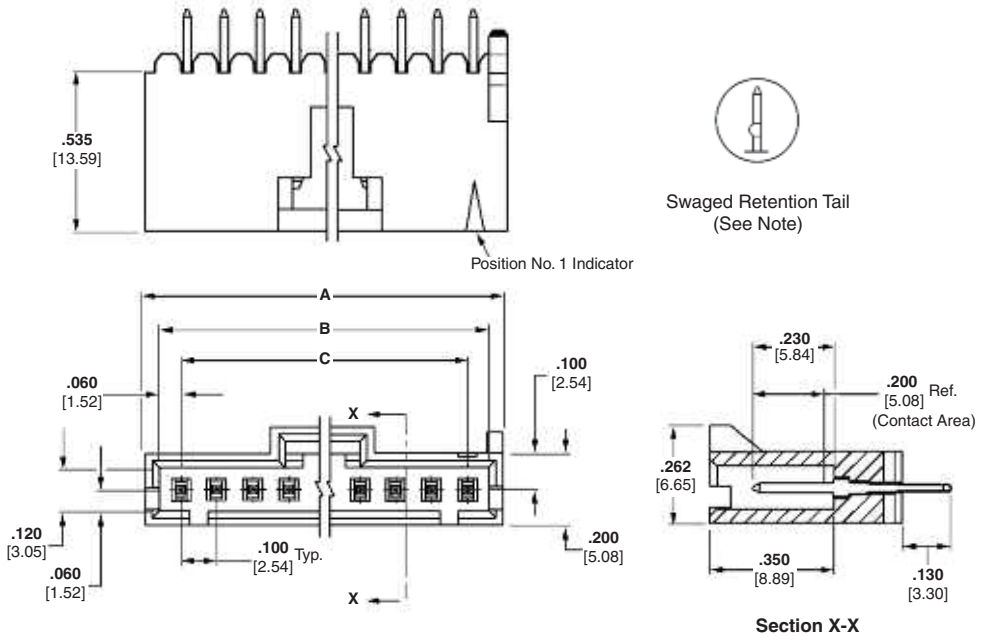

**Recommended PC Board Hole Layout (Stencil Thickness = .010 [0.25])**

\*±.003 [±0.08] tolerance not to accumulate within one connector pattern

No. of Pos.	Dimensions			Polarized/Latching Header, High-Temp
	A	B	C	
2	.300 [7.62]	.220 [5.59]	.100 [2.54]	5-104809-1
3	.400 [10.16]	.320 [8.13]	.200 [5.08]	5-104809-2
4	.500 [12.70]	.420 [10.67]	.300 [7.62]	5-104809-3
5	.600 [15.24]	.520 [13.21]	.400 [10.16]	5-104809-4
6	.700 [17.78]	.620 [15.75]	.500 [12.70]	5-104809-5
7	.800 [20.32]	.720 [18.29]	.600 [15.24]	5-104809-6
8	.900 [22.86]	.820 [20.83]	.700 [17.78]	5-104809-7
9	1.000 [25.40]	.920 [23.37]	.800 [20.32]	5-104809-8
10	1.100 [27.94]	1.020 [25.91]	.900 [22.86]	5-104809-9
11	1.200 [30.48]	1.120 [28.45]	1.000 [25.40]	6-104809-0
12	1.300 [33.02]	1.220 [30.99]	1.100 [27.94]	6-104809-1

**Note:** All part numbers are RoHS compliant.

## MTE Headers, Polarized/Latching, Through-Hole, Surface Mount Compatible, Single-Row, .100 [2.54] Centerline

### .025 [0.64] Square Right-Angle Post (With Holddown)



#### Material and Finish

**Housing** — Black thermoplastic, 94V-0 rated

**Posts** — Brass, duplex plated .000015 [0.00038] gold on contact area, .000100 [0.00254] min. tin on solder tail, with entire post underplated .000050 [0.00127] nickel

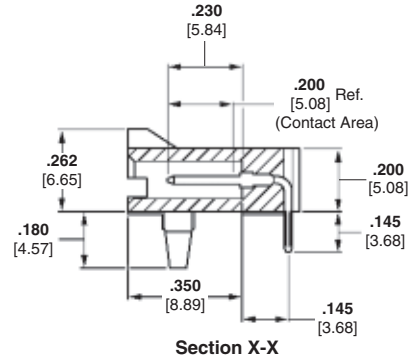
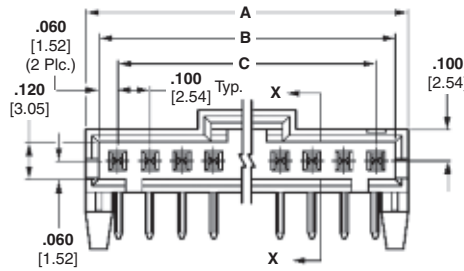
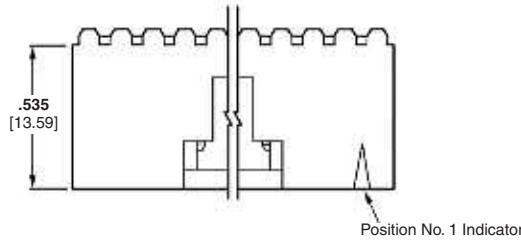

#### Related Product Data

**Mateable AMPMODU MTE Products** —

**Receptacle Assemblies (Polarized/Latching)** — pages 230, 231

**Receptacle Assemblies with Guide Ribs (installed in Single-Row Coupling Shroud)** — pages 232, 233, 235, 240

**Technical Documents** — pages 277, 278

**Product Specification** 108-25034

**Application Specification** 114-25026

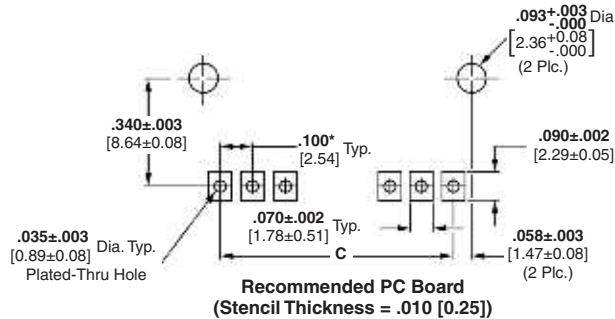

**Recommended PC Board (Stencil Thickness = .010 [0.25])**

\*±.003 [±0.08]; tolerance is not to accumulate within one connector pattern.

No. of Pos.	Dimensions			Right-Angle Header with Hold Down
	A	B	C	
2	.300 [7.62]	.220 [5.59]	.100 [2.54]	5-104361-1
3	.400 [10.16]	.320 [8.13]	.200 [5.08]	5-104361-2
4	.500 [12.70]	.420 [10.67]	.300 [7.62]	5-104361-3
5	.600 [15.24]	.520 [13.21]	.400 [10.16]	5-104361-4
6	.700 [17.78]	.620 [15.75]	.500 [12.70]	5-104361-5
7	.800 [20.32]	.720 [18.29]	.600 [15.24]	5-104361-6
8	.900 [22.86]	.820 [20.83]	.700 [17.78]	5-104361-7
9	1.000 [25.40]	.920 [23.37]	.800 [20.32]	5-104361-8
10	1.100 [27.94]	1.020 [25.91]	.900 [22.86]	5-104361-9
11	1.200 [30.48]	1.120 [28.44]	1.000 [25.40]	6-104361-0
12	1.300 [33.02]	1.220 [30.99]	1.100 [27.94]	6-104361-1
13	1.400 [35.56]	1.320 [33.53]	1.200 [30.48]	6-104361-2

No. of Pos.	Dimensions			Right-Angle Header with Hold Down
	A	B	C	
14	1.500 [38.10]	1.420 [36.07]	1.300 [33.02]	6-104361-3
15	1.600 [40.64]	1.520 [38.61]	1.400 [35.56]	6-104361-4
16	1.700 [43.18]	1.620 [41.15]	1.500 [38.10]	6-104361-5
17	1.800 [45.72]	1.720 [43.69]	1.600 [40.64]	6-104361-6
18	1.900 [48.26]	1.820 [46.23]	1.700 [43.18]	6-104361-7
19	2.000 [50.80]	1.920 [48.77]	1.800 [45.72]	6-104361-8
20	2.100 [53.34]	2.020 [51.31]	1.900 [48.26]	6-104361-9
21	2.200 [55.88]	2.120 [53.85]	2.000 [50.80]	7-104361-0
22	2.300 [58.42]	2.220 [56.39]	2.100 [53.34]	7-104361-1
23	2.400 [60.96]	2.320 [58.93]	2.200 [55.88]	7-104361-2
24	2.500 [63.50]	2.420 [61.47]	2.300 [58.42]	7-104361-3
25	2.600 [66.04]	2.520 [64.01]	2.400 [60.96]	7-104361-4

**Note:** All part numbers are RoHS compliant.

## MTE Headers, Right-Angle, Polarized/Latching, Surface Mount

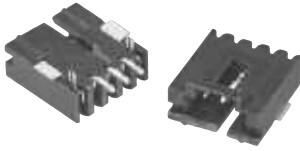

### Material and Finish

**Housing** — Black thermoplastic, 94V-0 rated

**Posts** — Brass, plated as follows:

**Plating A** — Duplex plated .000030 [.00076] gold on contact area, .000100 [.00254] min. tin on solder area, with entire post underplated .000050 [.00127] nickel.

**Plating B** — Duplex plated .000015 [.00038] gold on contact area, .000100 [.00254] min. tin on solder area, with entire post underplated .000050 [.00127] nickel.

**Plating C** — .000100 [.00254] tin over .000050 [.00127] nickel on entire post

### Recommended PC Board Layout

(Refer to MTE Application Spec. 114-25026 for Stencil Aperture Layout Using .006 [0.152] or .008 [0.203] Stencil Thickness)

### Related Product Data

**Mateable AMPMODU MTE Products** —

**Receptacle Assemblies (Polarized/Latching)** — pages 230, 231

**Receptacle Assemblies with Guide Ribs (installed in Single-Row Coupling Shroud)** — pages 232, 233, 235, 240

**Technical Documents** — pages 277, 278

**Product Specification**  
108-25034

**Application Specification**  
114-25026

**Note:** All part numbers are RoHS compliant.

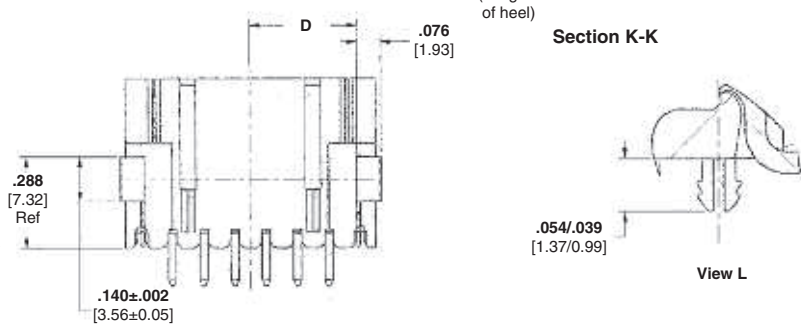
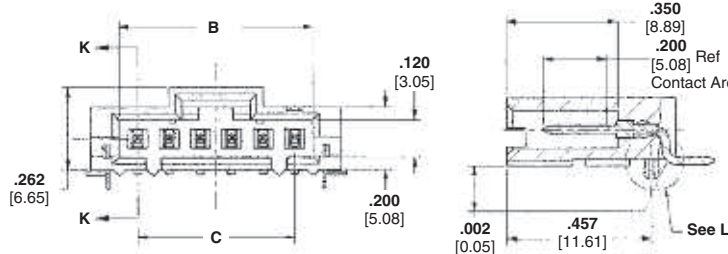
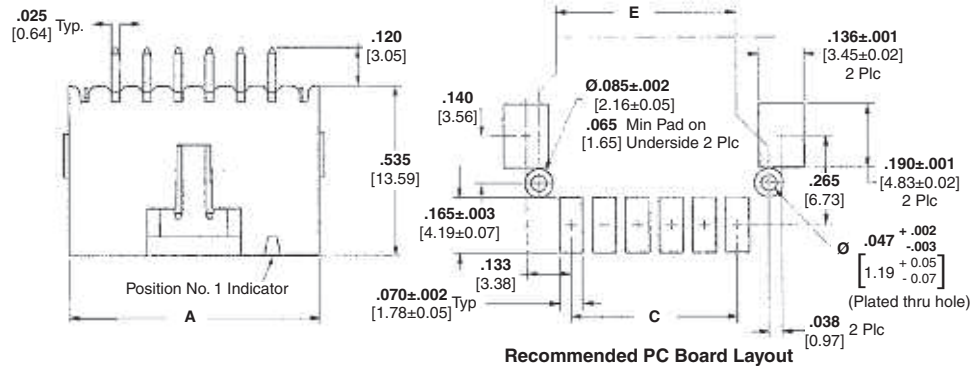

No. of Pos.	Dimensions					Right-Angle Latching SMT Headers		
	A	B	C	D	E	Plating A	Plating B	Plating C
2	.400 [10.16]	.220 [5.59]	.100 [2.54]	.140 [3.56]	.290 [7.37]	5-147323-1	5-147278-1	5-147324-1
3	.500 [12.70]	.320 [8.13]	.200 [5.08]	.190 [4.83]	.390 [9.91]	5-147323-2	5-147278-2	5-147324-2
4	.600 [15.24]	.420 [10.67]	.300 [7.62]	.240 [6.10]	.490 [12.45]	5-147323-3	5-147278-3	5-147324-3
5	.700 [17.78]	.520 [13.21]	.400 [10.16]	.290 [7.37]	.590 [14.99]	5-147323-4	5-147278-4	5-147324-4
6	.800 [20.32]	.620 [15.75]	.500 [12.70]	.340 [8.64]	.690 [17.53]	5-147323-5	5-147278-5	5-147324-5
7	.900 [22.86]	.720 [18.29]	.600 [15.24]	.390 [9.91]	.790 [20.07]	5-147323-6	5-147278-6	5-147324-6
8	1.000 [25.40]	.820 [20.83]	.700 [17.78]	.440 [11.18]	.890 [22.61]	5-147323-7	5-147278-7	5-147324-7
9	1.100 [27.94]	.920 [23.37]	.800 [20.32]	.490 [12.45]	.990 [25.15]	5-147323-8	5-147278-8	5-147324-8
10	1.200 [30.48]	1.020 [25.91]	.900 [22.86]	.540 [13.72]	1.090 [27.69]	5-147323-9	5-147278-9	5-147324-9
11	1.300 [33.02]	1.120 [28.45]	1.000 [25.40]	.590 [14.99]	1.190 [30.23]	6-147323-0	6-147278-0	6-147324-0
12	1.400 [35.56]	1.220 [30.99]	1.100 [27.94]	.640 [16.26]	1.290 [32.77]	6-147323-1	6-147278-1	6-147324-1
13	1.500 [38.10]	1.320 [33.53]	1.200 [30.48]	.690 [17.53]	1.390 [35.31]	6-147323-2	6-147278-2	6-147324-2
14	1.600 [40.64]	1.420 [36.07]	1.300 [33.02]	.740 [18.80]	1.490 [37.85]	6-147323-3	6-147278-3	6-147324-3
15	1.700 [43.18]	1.520 [38.61]	1.400 [35.56]	.790 [20.07]	1.590 [40.39]	6-147323-4	6-147278-4	6-147324-4
16	1.800 [45.72]	1.620 [41.15]	1.500 [38.10]	.840 [21.34]	1.690 [42.93]	6-147323-5	6-147278-5	6-147324-5
17	1.900 [48.26]	1.720 [43.69]	1.600 [40.64]	.890 [22.61]	1.790 [45.47]	6-147323-6	6-147278-6	6-147324-6
18	2.000 [50.80]	1.820 [46.23]	1.700 [43.18]	.940 [23.88]	1.890 [48.01]	6-147323-7	6-147278-7	6-147324-7
19	2.100 [53.34]	1.920 [48.77]	1.800 [45.72]	.990 [25.15]	1.990 [50.55]	6-147323-8	6-147278-8	6-147324-8
20	2.200 [55.88]	2.020 [51.31]	1.900 [48.26]	1.040 [26.42]	2.090 [53.09]	6-147323-9	6-147278-9	6-147324-9
21	2.300 [58.42]	2.120 [53.85]	2.000 [50.80]	1.090 [27.69]	2.190 [55.63]	7-147323-0	7-147278-0	7-147324-0
22	2.400 [60.96]	2.220 [56.39]	2.100 [53.34]	1.140 [28.96]	2.290 [58.17]	7-147323-1	7-147278-1	7-147324-1
23	2.500 [63.50]	2.320 [58.93]	2.200 [55.88]	1.190 [30.23]	2.390 [60.71]	7-147323-2	7-147278-2	7-147324-2
24	2.600 [66.04]	2.420 [61.47]	2.300 [58.42]	1.240 [31.50]	2.490 [63.25]	7-147323-3	7-147278-3	7-147324-3
25	2.700 [68.58]	2.520 [64.01]	2.400 [60.96]	1.290 [32.77]	2.590 [65.79]	7-147323-4	7-147278-4	7-147324-4

## MTE Headers, Vertical, Polarized/Latching, Surface Mount

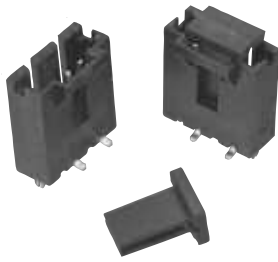

### Material and Finish

**Housing** — Black thermoplastic, 94V-0 rated

**Posts** — Brass, plated as follows:

**Plating A** — Duplex plated .000030 [.00076] gold on contact area, .000100 [.00254] min. tin on solder area, with entire post underplated .000050 [.00127] nickel.

**Plating B** — Duplex plated .000015 [.00038] gold on contact area, .000100 [.00254] min. tin on solder area, with entire post underplated .000050 [.00127] nickel.

**Plating C** — .000100 [.00254] tin over .000050 [.00127] nickel on entire post

### Recommended PC Board Layout

(Refer to MTE Application Spec. 114-25026 for Stencil Aperture Layout using .006 [0.152] or .008 [0.203] stencil thickness

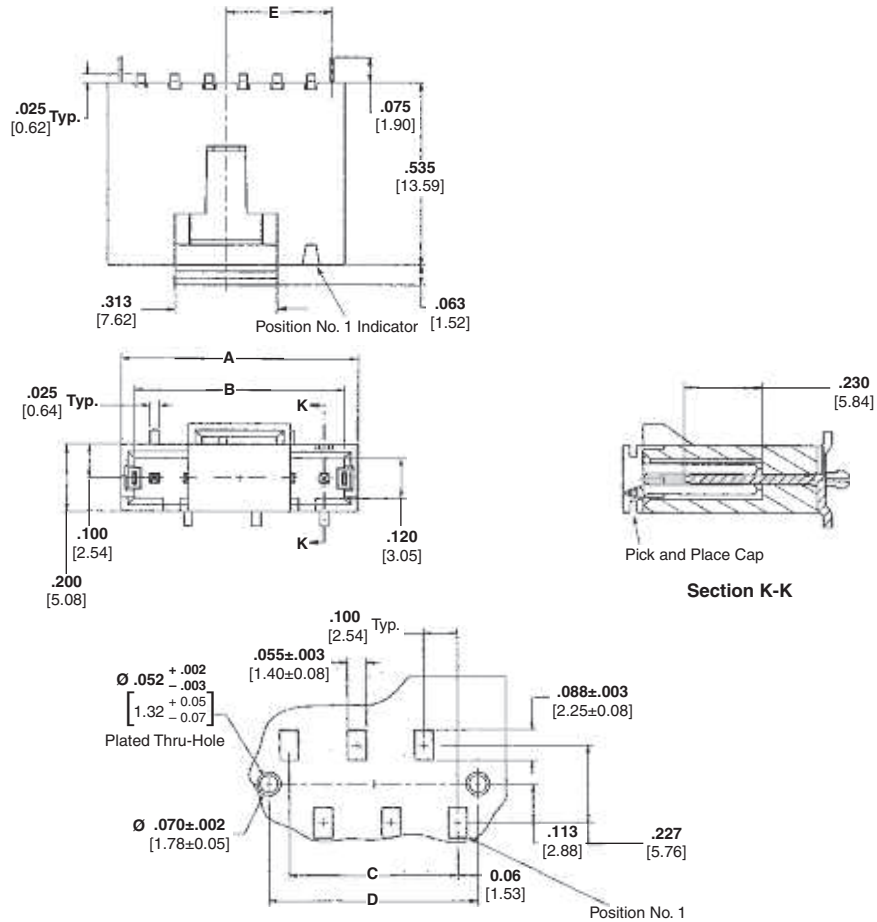

Recommended PC Board Layout

### Related Product Data

**Mateable AMPMODU MTE Products** —

**Receptacle Assemblies (Polarized/Latching)** — pages 230, 231

**Receptacle Assemblies with Guide Ribs (installed in Single-Row Coupling Shroud)** — pages 232, 233, 235, 240

**Technical Documents** — pages 277, 278

**Product Specification** 108-25034

**Application Specification** 114-25026

**Note:** All part numbers are RoHS compliant.

No. of Pos.	Dimensions					Vertical SMT Headers		
	A	B	C	D	E	Plating A	Plating B	Plating C
2	.300[7.62]	.220[5.59]	.100[2.54]	.220[5.60]	.110[2.80]	5-1375583-1	5-1375582-1	5-1375549-1
3	.400[10.16]	.320[8.13]	.200[5.08]	.320[8.14]	.160[4.07]	5-1375583-2	5-1375582-2	5-1375549-2
4	.500[12.70]	.420[10.67]	.300[7.62]	.420[10.68]	.210[5.34]	5-1375583-3	5-1375582-3	5-1375549-3
5	.600[15.24]	.520[13.21]	.400[10.16]	.520[13.22]	.260[6.61]	5-1375583-4	5-1375582-4	5-1375549-4
6	.700[17.78]	.620[15.75]	.500[12.70]	.620[15.76]	.310[7.88]	5-1375583-5	5-1375582-5	5-1375549-5
7	.800[20.32]	.720[18.29]	.600[15.24]	.720[18.30]	.360[9.15]	5-1375583-6	5-1375582-6	5-1375549-6
8	.900[22.86]	.820[20.83]	.700[17.78]	.820[20.84]	.410[10.42]	5-1375583-7	5-1375582-7	5-1375549-7
9	1.000[25.40]	.920[23.37]	.800[20.32]	.920[23.38]	.460[11.69]	5-1375583-8	5-1375582-8	5-1375549-8
10	1.100[27.94]	1.020[25.91]	.900[22.86]	1.020[25.92]	.510[12.96]	5-1375583-9	5-1375582-9	5-1375549-9
11	1.200[30.48]	1.120[28.45]	1.000[25.40]	1.120[28.46]	.560[14.23]	6-1375583-0	6-1375582-0	6-1375549-0
12	1.300[33.02]	1.220[30.99]	1.100[27.94]	1.220[31.00]	.610[15.50]	6-1375583-1	6-1375582-1	6-1375549-1
13	1.400[35.56]	1.320[33.53]	1.200[30.48]	1.320[33.54]	.660[16.77]	6-1375583-2	6-1375582-2	6-1375549-2
14	1.500[38.10]	1.420[36.07]	1.300[33.02]	1.420[36.08]	.710[18.04]	6-1375583-3	6-1375582-3	6-1375549-3
15	1.600[40.64]	1.520[38.61]	1.400[35.56]	1.520[38.62]	.760[19.31]	6-1375583-4	6-1375582-4	6-1375549-4
16	1.700[43.18]	1.620[41.15]	1.500[38.10]	1.620[41.16]	.810[20.58]	6-1375583-5	6-1375582-5	6-1375549-5
17	1.800[45.72]	1.720[43.69]	1.600[40.64]	1.720[43.70]	.860[21.85]	6-1375583-6	6-1375582-6	6-1375549-6
18	1.900[48.26]	1.820[46.23]	1.700[43.18]	1.820[46.24]	.910[23.12]	6-1375583-7	6-1375582-7	6-1375549-7
19	2.000[50.80]	1.920[48.77]	1.800[45.72]	1.920[48.78]	.960[24.39]	6-1375583-8	6-1375582-8	6-1375549-8
20	2.100[53.34]	2.020[51.31]	1.900[48.26]	2.020[51.32]	1.010[25.66]	6-1375583-9	6-1375582-9	6-1375549-9
21	2.200[55.88]	2.120[53.85]	2.000[50.80]	2.120[53.86]	1.060[26.93]	7-1375583-0	7-1375582-0	7-1375549-0
22	2.300[58.42]	2.220[56.39]	2.100[53.34]	2.220[56.40]	1.110[28.20]	7-1375583-1	7-1375582-1	7-1375549-1
23	2.400[60.96]	2.320[58.93]	2.200[55.88]	2.320[58.94]	1.160[29.47]	7-1375583-2	7-1375582-2	7-1375549-2
24	2.500[63.50]	2.420[61.47]	2.300[58.42]	2.420[61.48]	1.210[30.74]	7-1375583-3	7-1375582-3	7-1375549-3
25	2.600[66.04]	2.520[64.01]	2.400[60.96]	2.520[64.02]	1.260[32.01]	7-1375583-4	7-1375582-4	7-1375549-4

## Interchangeable Contacts, Wire Crimp (Snap-In)

### Material and Finish

Copper alloy C7025, plated as follows:

**Plating A** — Duplex plated .000030 [0.00076] min. gold on contact area, .000050 [0.00127] min. tin in crimp area, with entire contact underplated .000050 [0.00127] min. nickel

**Plating B** — Duplex plated .000015 [0.00038] min. gold on contact area, .000050 [0.00127] min. tin in crimp area, with entire contact underplated .000050 [0.00127] min. nickel

**Plating C** — .000100 [0.00254] min. tin over .000050 [0.00127] min. nickel on entire contact



**Keying Plug**

**Part No. 104072-1**

Ten plugs are supplied per strip.  
Order quantity reflects the number of strips required.



**Extraction/Lance Reset**  
**Tool No. 843477-1**

### Short Point Receptacles

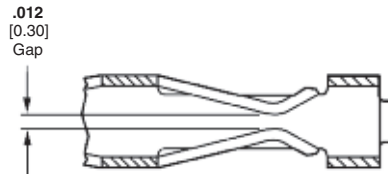
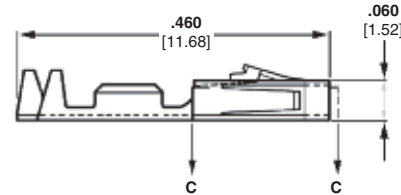
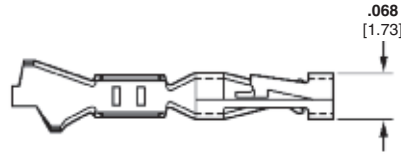

**Section C - C**

### Related Product Data

**Performance Characteristics** — page 221

**Housings used in** — Short Point—pages 223, 224

**AMPMODU MTE Unloaded Housings** — pages 228-233

**Application Tooling** — pages 270-272

**Technical Documents** — pages 277, 278

**Product Specification**  
108-1472, 108-1472-1

**Application Specification**  
114-25038

Wire Size Range AWG	Ins. Dia. Range [mm <sup>2</sup> ]	Finish	Contact Part No. (Standard Pressure)		Heavy Duty Miniature Applicator for AMP-O-ELECTRIC Machine*	Applicator for AMP-O-MATIC Stripper/Crimper Machine	Hand Tool Nos.	
			Strip Form	Loose Piece				
32-28	0.03-0.08	.025-.060 0.64-1.52	Plating A	1-104481-1	1-104481-3	567296-2	466980-1	91518-1
			Plating B	1-104481-0	1-104481-2			
			Plating C	5-104481-2	5-104481-6			
26-22	0.13-0.3	.025-.060 0.64-1.52	Plating A	1-104480-3	1-104480-6	567297-2	466981-1	91518-1
			Plating B	1-104480-2	1-104480-5			
			Plating C	1-104480-7	1-104480-4			
24-20	0.2-0.5	.025-.060 0.64-1.52	Plating A	1-104479-0	1-104479-3	567298-2	466982-1	91551-1
			Plating B	1-104479-9	1-104479-2			
			Plating C	1-104479-8	1-104479-1			

\*For use with Model "K" machines. Call the Technical Support Center (1-800-522-6752) for part nos. of applicators for use with the Model "G" machines (shown on page 270), as well as other bench machines and fully automatic AMPOMATOR lead making machines.

**Note:** These wire crimp contacts can be intermixed with insulation displacement crimp contacts.

**Note:** All part numbers are RoHS compliant.

**Interchangeable Contacts, Wire Crimp (Snap-In) (Continued)**

**Material and Finish**

Phosphor bronze, plated as follows:

**Plating A** — Duplex plated .000030 [0.00076] gold on contact area, .000030 [0.00076] min. tin in crimp area, with entire contact underplated .000050 [0.00127] nickel

**Plating B** — Duplex plated .000015 [0.00038] gold on contact area, .000030 [0.00076] min. tin on solder area, with entire contact underplated .000050 [0.00127] nickel

**Plating C** — .000100 [0.00254] tin over .000050 [0.00127] nickel on entire contact

**Pins**

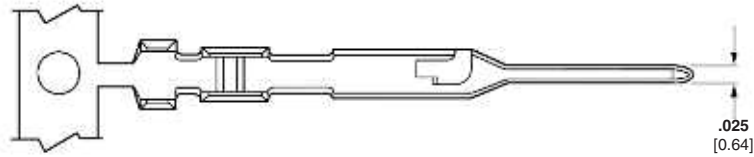

Extraction/Lance Reset  
Tool No. 843477-1

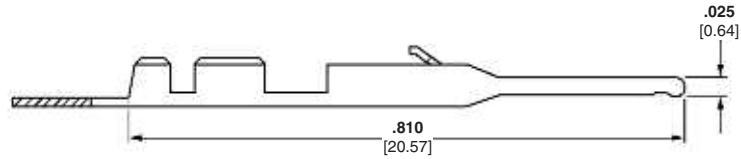

**Related Product Data**

**Performance Characteristics** — page 221

**AMPMODU MTE Unloaded Housings** — pages 228-233

**Application Tooling** — pages 270-272

**Technical Documents** — pages 277, 278

**Product Specification** 108-25034

**Application Specification** 114-25026

Wire Size Range AWG [mm <sup>2</sup> ]	Ins. Dia. Range	Finish	Contact Part No. (Standard Pressure)		Heavy Duty Miniature Applicator for AMP-O-LECTRIC Machine*	Applicator for AMP-O-MATIC Stripper/Crimper Machine	Hand Tool Nos.
			Strip Form	Loose Piece			
32-28 0.03-0.08	.025-.054 0.64-1.37	Plating A	5-104506-6	5-104506-7	—	—	58342-2
		Plating B	5-104506-4	5-104506-5			
		Plating C	5-104506-2	5-104506-3			
26-22 0.14-0.32	.036-.054 0.91-1.37	Plating A	5-104505-6	5-104505-7	567239-2	466983-1	91531-1
		Plating B	5-104505-4	5-104505-5			
		Plating C	5-104505-2	5-104505-3			

\*For use with AMP-O-LECTRIC Model "K" machines. Call Technical Support Center (1-800-522-6752) for part nos. of applicators for use with the AMP-O-LECTRIC Model "G" machines (shown on page 270), as well as other bench machines and fully automatic AMPOMATOR lead making machines.  
**Note:** These wire crimp contacts can be intermixed with insulation displacement crimp contacts.

**Note:** All part numbers are RoHS compliant.

## MT and Shielded MT Interconnection System

### Product Facts

- Full line of mass termination tooling offers lowest installed cost for most production needs
- Dual cantilever beams with anti-overstress features provide redundant contact of mating post and limit beam deflection, preventing permanent deformation
- Redundant insulation displacement slots provide for maximum reliability
- Integral wire strain relief on contact can prevent wire motion from being transmitted to wire termination areas
- Built-in contact post stop can protect terminated wire from being disturbed by over-insertion of mating post, prevents wire from entering contact area and positively limits mating connector depth
- Insulation displacement contacts and crimp, snap-in contacts are interchangeable
- Complete serviceability with replacement contacts
- Cover styles include low profile (polarized, non-polarized, latching and ejection) and standard profile (hermaphroditic and ejection)
- Connector housings may be stacked end-to-end within one pair of covers. All varieties of covers in this catalog are suitable for multiple housing stacking applications similar to the example illustrated in the photograph to the right
- Recognized under the Component Program of Underwriters Laboratories Inc., File No. E28476 
- Certified by Canadian Standards Association, File No. LR 7189 

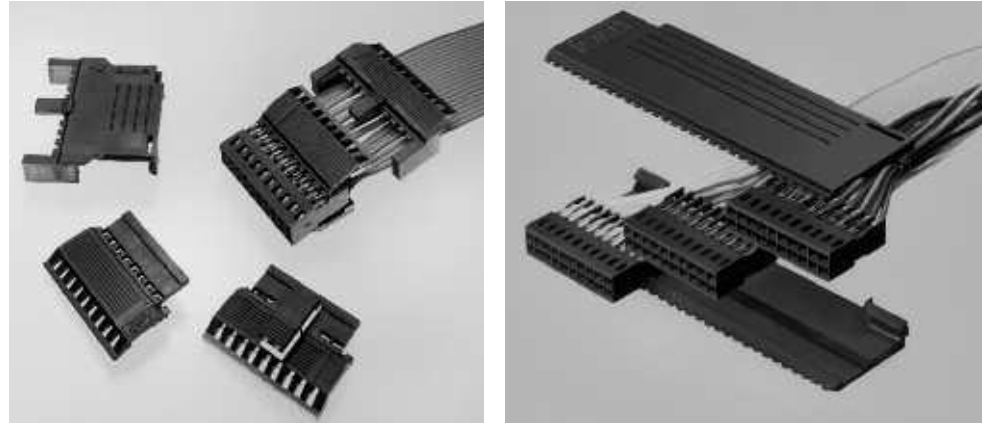

Typical Application of End-to-End Stacking

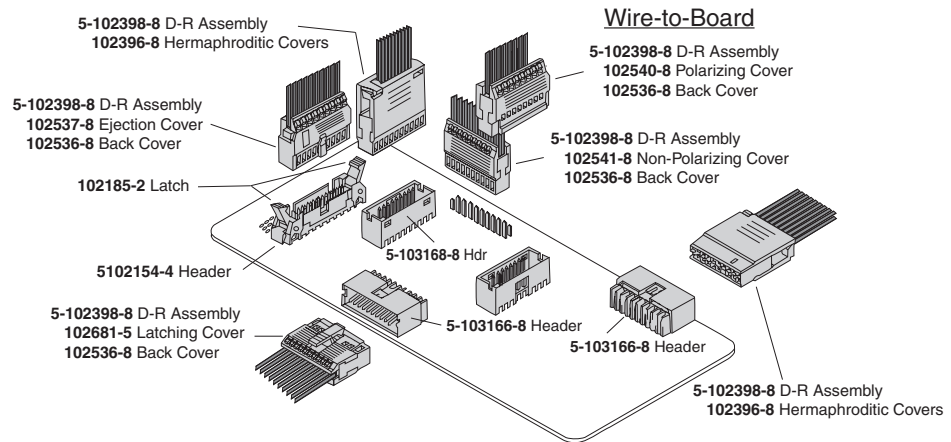

The AMPMODU MT and Shielded MT Interconnection System offers labor and cost savings through mass termination technology, while maintaining the time-proven reliability of the AMPMODU product family. The MT system is comprised of preloaded, double-row receptacle assemblies with snap-on covers and a variety of shielding hardware and accessories. The system is supported by a full line of mass termination tooling to meet virtually most production needs.

The insulation displacement contact, the heart of the MT

system, features a mating interface that is the same as the conventional AMPMODU crimp, snap-in contact, featuring dual cantilever beams, built-in overstress protection and a completely enclosed "box" design.

To reduce EMI/ESD (electromagnetic interference/electrostatic discharge) at the input-output interface, add-on metal shields can be used to convert standard MT connectors to shielded MT connectors.

### Performance Characteristics

- Contact Current Rating** — 3 amperes for single contact in free air. (Amperage could vary due to ambient temperature, wire size and duty cycles.)
- Operating Temperature** — -65°C to +105°C
- Termination Resistance** — 12 milliohms max.
- Max. Mating Force** — High pressure - 26 oz. [7.23 N]  
Standard pressure - 9 oz. [2.50 N]
- Min. Unmating Force** — High pressure — 5 oz. [1.39 N]  
Standard pressure — 1.5 oz. [0.417 N]
- Contact Retention in Housing** — 5 lb. [22.24 N] per contact min.

**Note:** All part numbers are RoHS compliant.

## MT Receptacle Assemblies, Double-Row .100 x .100 [2.54 x 2.54] Centerline

### Housings Pre-loaded with Standard Pressure Contacts



### Material and Finish

**Housing** — Glass-filled thermoplastic, black, 94V-0 rated

**Contacts** — Copper alloy, duplex plated .000030 [0.00076] gold in mating area, .000050 [0.00127] tin on solder tail, with entire contact underplated .000050 [0.00127] nickel

### Related Product Data

**Mateable Connectors** — pages 117, 122, 126, 130, 264

**Cable Insulation Wall Thickness** — .015 [0.39] max.

**Cable Insulation Diameter** — .050 [1.27] max.

**Mating Post Length** — .222-.273 [5.64-6.94] max.

**Performance Characteristics** — page 255

**Replacement Contacts** — page 265

**Connector Covers** — pages 258, 259

**Application Tooling** — pages 273-275

**Technical Documents** — pages 277, 278

**Product Specification**  
108-25015, 108-25018, 108-25030

**Application Specification**  
114-25032

**Instruction Sheet**  
408-6532

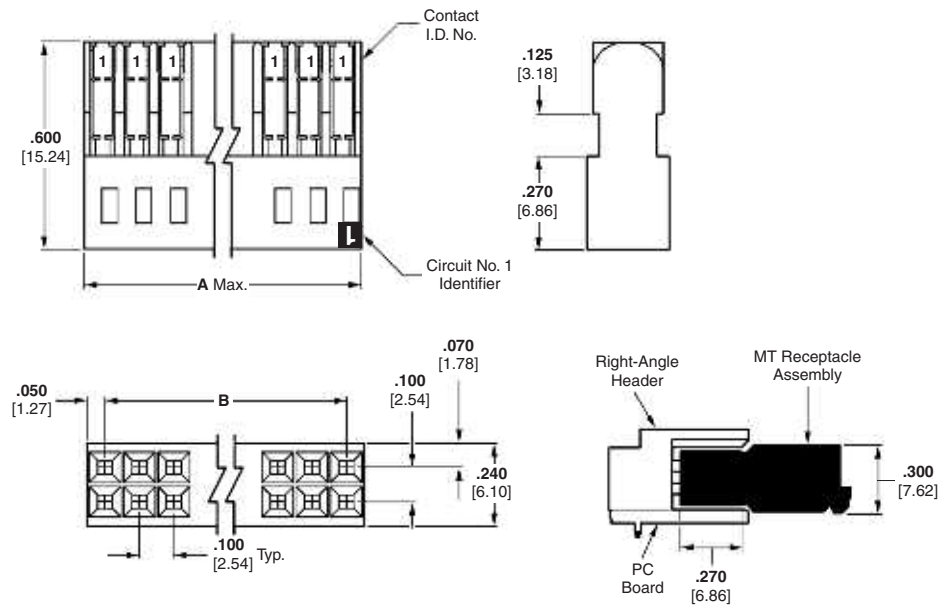

No. of Pos.	Dimensions		Part Nos. (Stamped)			Unloaded Housings
			Wire Size Range			
			30-26 AWG [0.05-0.15 mm <sup>2</sup> ]	26-22 AWG [0.12-0.3 mm <sup>2</sup> ]	22-20 AWG [0.3-0.6 mm <sup>2</sup> ]	
6	.300 [7.62]	.200 [5.08]	5-102393-1	5-102398-1	5-102448-1	102394-1
8	.400 [10.16]	.300 [7.62]	5-102393-2	5-102398-2	5-102448-2	102394-2
10	.500 [12.70]	.400 [10.16]	5-102393-3	5-102398-3	5-102448-3	102394-3
12	.600 [15.24]	.500 [12.70]	5-102393-4	5-102398-4	5-102448-4	102394-4
14	.700 [17.78]	.600 [15.24]	5-102393-5	5-102398-5	5-102448-5	102394-5
16	.800 [20.32]	.700 [17.78]	5-102393-6	5-102398-6	5-102448-6	102394-6
18	.900 [22.86]	.800 [20.32]	5-102393-7	5-102398-7	5-102448-7	102394-7
20	1.000 [25.40]	.900 [22.86]	5-102393-8	5-102398-8	5-102448-8	102394-8
22	1.100 [27.94]	1.000 [25.40]	5-102393-9	5-102398-9	5-102448-9	102394-9
24	1.200 [30.48]	1.100 [27.94]	6-102393-0	6-102398-0	6-102448-0	1-102394-0
26	1.300 [33.02]	1.200 [30.48]	6-102393-1	6-102398-1	6-102448-1	1-102394-1
28	1.400 [35.56]	1.300 [33.02]	6-102393-2	6-102398-2	6-102448-2	1-102394-2
30	1.500 [38.10]	1.400 [35.56]	6-102393-3	6-102398-3	6-102448-3	1-102394-3
32	1.600 [40.64]	1.500 [38.10]	6-102393-4	6-102398-4	6-102448-4	1-102394-4
34	1.700 [43.18]	1.600 [40.64]	6-102393-5	6-102398-5	6-102448-5	1-102394-5
40	2.000 [50.80]	1.900 [48.26]	6-102393-8	6-102398-8	6-102448-8	1-102394-8
50	2.500 [63.50]	2.400 [60.96]	7-102393-3	7-102398-3	7-102448-3	2-102394-3
60	3.000 [76.20]	2.900 [73.66]	7-102393-8	7-102398-8	7-102448-8	2-102394-8
64	3.200 [81.28]	3.100 [78.74]	8-102393-0	8-102398-0	8-102448-0	3-102394-0

**Note:** Contact Extraction/Lance Reset Tool No. 843477-3, see page 265.

### Keying Plugs

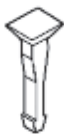

**Part No. 86286-1**  
(Plugs into receptacle contact)

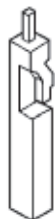

**Part No. 87077-2**  
(Plugs directly into housing)

**Material** — Natural color nylon

**Note:** All part numbers are RoHS compliant.



## MT Receptacle Assemblies, Double-Row .100 x .100 [2.54 x 2.54] Centerline (Continued)

### Housings Pre-loaded with High Pressure Contacts

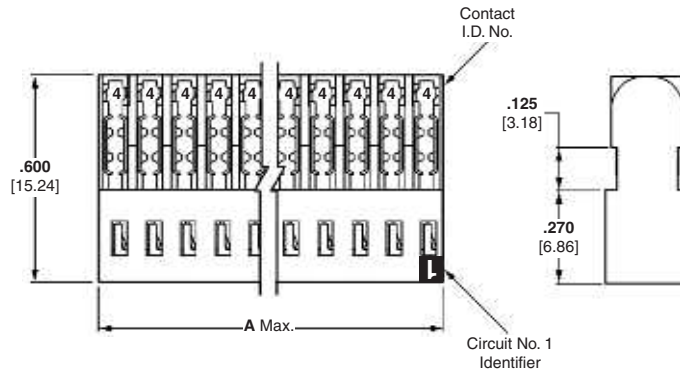

### Material and Finish

**Housing** — Glass-filled thermoplastic, black, 94V-0 rated

**Contacts** — Copper alloy, duplex plated .000030 [0.00076] gold in mating area, .000050 [0.00127] tin on solder tails, with entire contact underplated .000050 [0.00127] nickel

### Related Product Data

**Mateable Connectors** — pages 117, 122, 126, 130, 264

**Cable Insulation Wall Thickness** — .015 [0.39] max.

**Cable Insulation Diameter** — .050 [1.27] max.

**Mating Post Length** — .200-.273 [5.64-6.94] max.

**Performance Characteristics** — page 255

**Replacement Contacts** — page 265

**Connector Covers** — pages 258, 259

**Application Tooling** — pages 273-275

**Technical Documents** — pages 277, 278

**Product Specification** 108-25015, 108-25018, 108-25030

**Application Specification** 114-25032

**Instruction Sheet** 408-6532

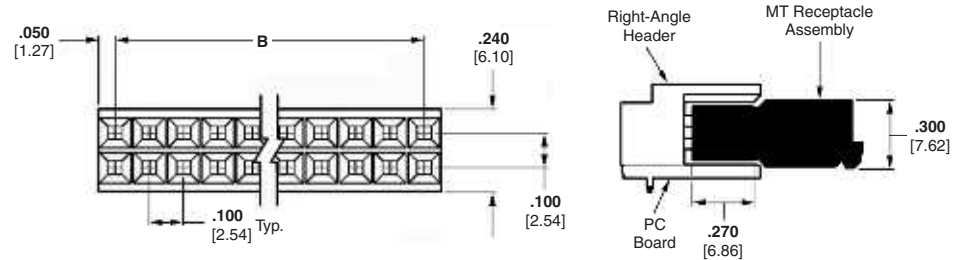

No. of Pos.	Dimensions		Part Nos. (Stamped*)		
	A	B	Wire Size Range		
			30-26 AWG [0.05-0.15 mm <sup>2</sup> ]	26-22 AWG [0.12-0.3 mm <sup>2</sup> ]	22-20 AWG [0.3-0.6 mm <sup>2</sup> ]
6	.300 [7.62]	.200 [5.08]	5-102693-1	5-102694-1	5-102695-1
8	.400 [10.16]	.300 [7.62]	5-102693-2	5-102694-2	5-102695-2
10	.500 [12.70]	.400 [10.16]	5-102693-3	5-102694-3	5-102695-3
12	.600 [15.24]	.500 [12.70]	5-102693-4	5-102694-4	5-102695-4
14	.700 [17.78]	.600 [15.24]	5-102693-5	5-102694-5	5-102695-5
16	.800 [20.32]	.700 [17.78]	5-102693-6	5-102694-6	5-102695-6
18	.900 [22.86]	.800 [20.32]	5-102693-7	5-102694-7	5-102695-7
20	1.000 [25.40]	.900 [22.86]	5-102693-8	5-102694-8	5-102695-8

\*Cavity identification — first cavity (one side); TE Part No. and date code stamped on housing where size permits.

**Note:** Contact Extraction/Lance Reset Tool No. 843477-3, see page 265.

### Keying Plugs

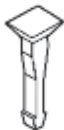

**Part No. 86286-1**  
(Plugs into receptacle contact)



**Part No. 87077-2**  
(Plugs directly into housing)

**Material** — Natural color nylon

**Note:** All part numbers are RoHS compliant.

## Low Profile Covers for Double-Row MT Receptacle Assemblies

### Material

Black thermoplastic, flame retardant

### Related Product Data

For use on Double-Row MT Receptacle Assemblies — pages 256, 257

**Technical Documents** —  
pages 277, 278

**Product Specification**  
108-25015, 108-25018, 108-25030

**Application Specification**  
114-25032

**Instruction Sheet**  
408-6532

**Note:** See page 259 for Low Profile Cover Part Nos.

### Front Covers

#### A - Polarizing Cover

(Mates with AMPMODU 4-sided shrouded headers. Refer to pages 117, 122, 126, 130.)

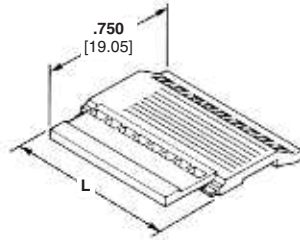

#### B - Latching Cover

(Mates with AMPMODU 4-sided shrouded headers with extraction slot. Refer to pages 117, 122, 126, 130.)

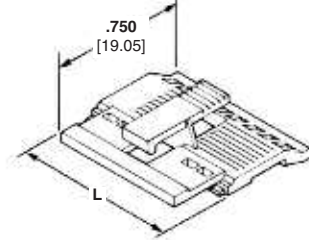

#### C - Ejection Cover

(Mates with AMP-LATCH universal ejection style pin headers equipped with latching ears, Part No. 102185-2 (with push tabs) or Part No. 102312-2 (without push tabs), see TE Catalog 82012.

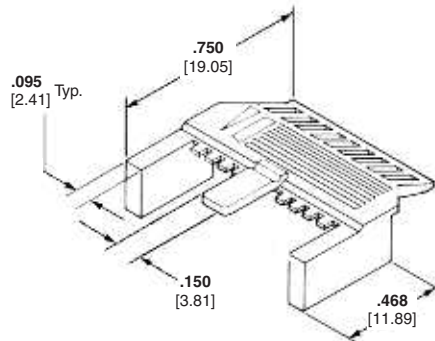

#### D - Non-Polarizing Cover

(Designed for use with shielded connectors, pages 261 & 262; or for non-polarizing applications.)

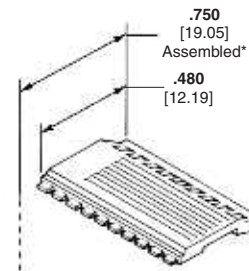

\*Dimension applies to cover when installed on connector housing.

### Back Covers

#### E - For Shielding and Non-Shielding Applications

(For use with any low profile cover.)

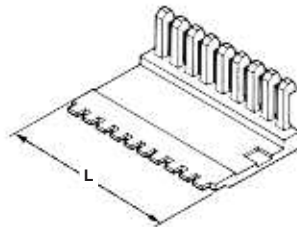

#### F - For Shielding Applications

(For use with Non-Polarizing Cover only.)

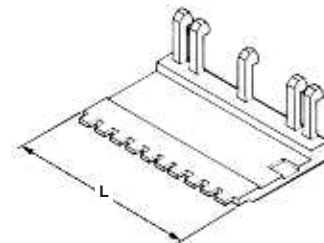

**Note:** All part numbers are RoHS compliant.

## Standard Profile Covers for Double-Row MT Receptacle Assemblies

### Material

Black thermoplastic, flame retardant

### Related Product Data

For use on Double-Row MT Receptacle Assemblies — pages 256, 257

### Technical Documents — pages 277, 278

**Product Specification**  
108-25015, 108-25018, 108-25030

**Application Specification**  
114-25032

**Instruction Sheet**  
408-6532

### G - Hermaphroditic Cover

(Two hermaphroditic covers can be used or one hermaphroditic cover can be used with an H Ejection Cover.)

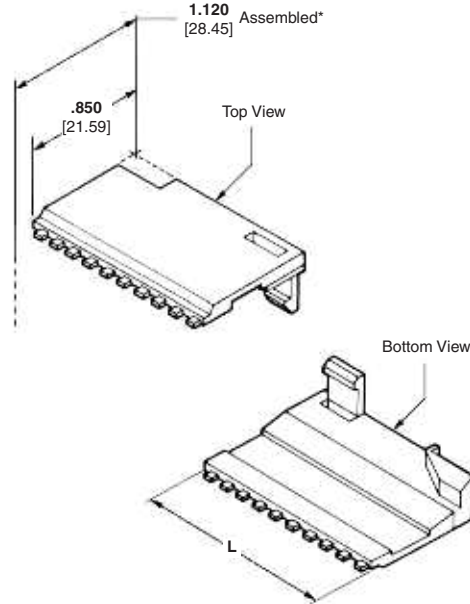

### H - Ejection Cover

(Mates with AMP-LATCH universal ejection style pin headers equipped with latching ears, Part No. 102185-2 (with push tabs) or Part No. 102312-2 (without push tabs), see TE Catalog 82012.)

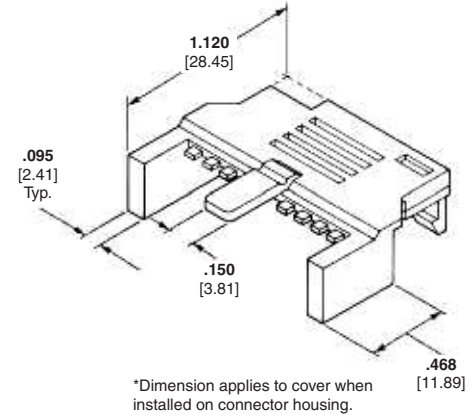

No. of Pos.	Dimension L	Low Profile Covers						Standard Profile Covers	
		Front Covers				Back Covers		G Hermaphroditic	H Ejection
		A Polarizing	B Latching	C Ejection	D Non-Polarizing	E Shielding and Non-Shielding Applications	F Shielding Applications		
6	.300 [7.62]	102540-1	—	102537-1	102541-1	102536-1	—	102396-1	—
8	.400 [10.16]	102540-2	—	102537-2	102541-2	102536-2	—	102396-2	—
10	.500 [12.70]	102540-3	—	102537-3	102541-3	102536-3	—	102396-3	—
12	.600 [15.24]	102540-4	102681-1	102537-4	102541-4	102536-4	102823-5	102396-4	—
14	.700 [17.78]	102540-5	102681-2	102537-5	102541-5	102536-5	102823-6	102396-5	—
16	.800 [20.32]	102540-6	102681-3	102537-6	102541-6	102536-6	102823-7	102396-6	—
18	.900 [22.86]	102540-7	102681-4	102537-7	102541-7	102536-7	102823-1	102396-7	—
20	1.000 [25.40]	102540-8	102681-5	102537-8	102541-8	102536-8	102823-4	102396-8	103268-6
22	1.100 [27.94]	102540-9	102681-6	102537-9	102541-9	102536-9	102823-8	102396-9	—
24	1.200 [30.48]	1-102540-0	102681-7	1-102537-0	1-102541-0	1-102536-0	102823-9	1-102396-0	103268-7
26	1.300 [33.02]	1-102540-1	102681-8	1-102537-1	1-102541-1	1-102536-1	1-102823-0	1-102396-1	103268-8
28	1.400 [35.56]	1-102540-2	102681-9	1-102537-2	1-102541-2	1-102536-2	1-102823-1	1-102396-2	—
30	1.500 [38.10]	1-102540-3	1-102681-0	1-102537-3	1-102541-3	1-102536-3	1-102823-2	1-102396-3	103268-9
32	1.600 [40.64]	—	1-102681-1	1-102537-4	1-102541-4	1-102536-4	1-102823-3	1-102396-4	—
34	1.700 [43.18]	—	1-102681-2	1-102537-5	1-102541-5	1-102536-5	1-102823-4	1-102396-5	1-103268-0
40	2.000 [50.80]	—	1-102681-5	1-102537-8	1-102541-8	1-102536-8	102823-2	1-102396-8	—
50	2.500 [63.50]	—	2-102681-0	2-102537-3	2-102541-3	2-102536-3	102823-3	2-102396-3	1-103268-3
60	3.000 [76.20]	—	—	2-102537-8	2-102541-8	2-102536-8	—	2-102396-8	—
64	3.200 [81.28]	—	—	3-102537-0	3-102541-0	3-102536-0	—	3-102396-0	—

**Note:** All part numbers are RoHS compliant.

## Shielding Hardware and Accessories for MT Interconnection System

### Product Facts

- Add-on shielding accessories for existing AMPMODU Standard MT and PC board mounted headers
- Compact design
- Tin plated copper alloy material
- Redundant cantilever beams provide for good peripheral contact, eliminating the need for a separate RF gasket
- Polarized mating
- 360° cable braid termination with cable jacket support
- Cable shielding hardware permits molded cable terminations after assembly
- Must be used with braided shielded cables
- Solder tabs on right-angle header shields are self-retaining in a PC board



Shielded MT Receptacles

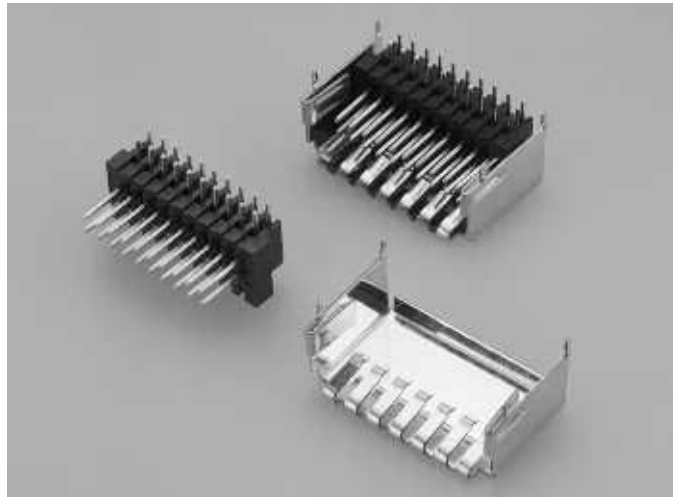

Shielded Right-Angle Headers

The shielded AMPMODU MT system features add-on metal shielding kits for double-row standard MT receptacle assemblies and double-row right-angle headers.

Cable shielding hardware consists of a ferrule and two stamped and formed shell halves. The inner shell half has a series of integral cantilever beams to provide

good peripheral contact with the mating outer shell half. This feature also eliminates the need for a separate RF gasket. Detents in the cantilever beam provide a positive lock when the two halves are mated. During assembly the inner and outer shell halves are snapped together over a terminated standard MT connector.

Shields for right-angle headers have integral cantilever beams which provide good contact with the mating shielded MT receptacle assembly, without the use of a separate RF gasket.

## Shielding Hardware and Accessories for Double-Row MT Receptacle Assemblies

### Two-Piece Shields—Straight Exit

#### Material and Finish

**Shell Halves** — Copper alloy, .020 [0.51] thick; pretinned .000030 [0.00076] min.

#### Related Product Data

**Double-Row MT Receptacle Assemblies** — pages 256, 257

**Non-Polarizing Covers (Part No. Series 102541 with back cover 102536 or 102823)** — pages 258, 259

**Shield Ferrules** — page 263

**Technical Documents** — pages 277, 278

**Product Specification**  
108-25015, 108-25018, 108-25030

**Application Specification**  
114-25032

**Instruction Sheet**  
408-6532

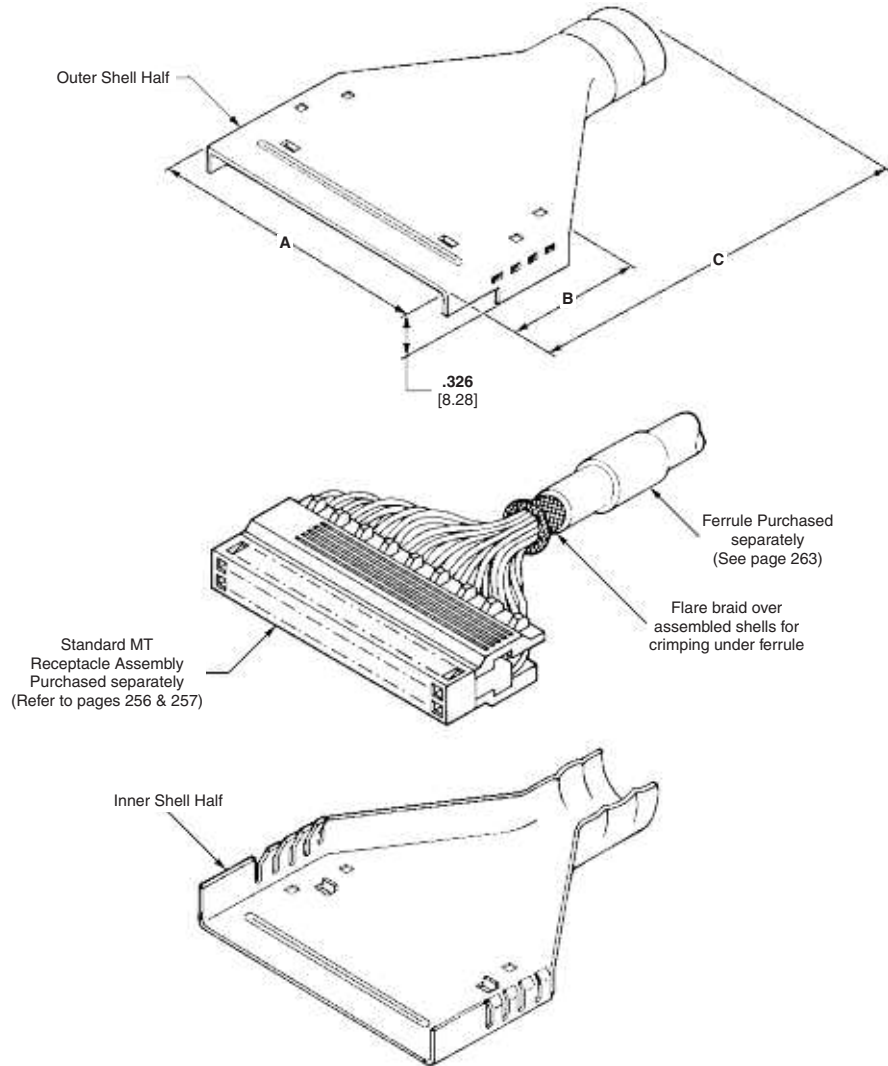

No. of Pos.	Dimensions			Part Nos.	
	A	B	C	Outer Shell	Inner Shell
6	.410 [10.41]	.817 [20.75]	1.268 [32.21]	102988-2	102987-6
10	.610 [15.49]	.817 [20.75]	1.667 [42.34]	103137-2	103136-2
16	.910 [23.11]	.950 [24.13]	1.925 [48.90]	103153-2	103152-2
26	1.410 [35.81]	.950 [24.13]	1.925 [48.90]	103341-2	103340-2
40	2.110 [53.59]	1.325 [33.66]	2.468 [62.69]	104272-1	104271-1
50	2.610 [66.29]	.950 [24.13]	2.468 [62.69]	103158-2	103157-2

**Note:** Match shield size to number of connector positions.

**Note:** All part numbers are RoHS compliant.

## Shielding Hardware and Accessories for Double-Row MT Receptacle Assemblies (Continued)

### Two-Piece Shields— Right-Angle Exit

#### Material and Finish

**Shell Halves** — Copper alloy, .020 [0.51] thick; pretinned .000030 [0.00076] min.

#### Related Product Data

**Double-Row MT Receptacle Assemblies** — pages 256, 257

**Non-Polarizing Covers (Part No. Series 102541 with back cover 102536 or 102823)** — pages 258, 259

**Shield Ferrules** — page 263

**Technical Documents** — pages 277, 278

**Product Specification**  
108-25015, 108-25018, 108-25030

**Application Specification**  
114-25032

**Instruction Sheet**  
408-6532

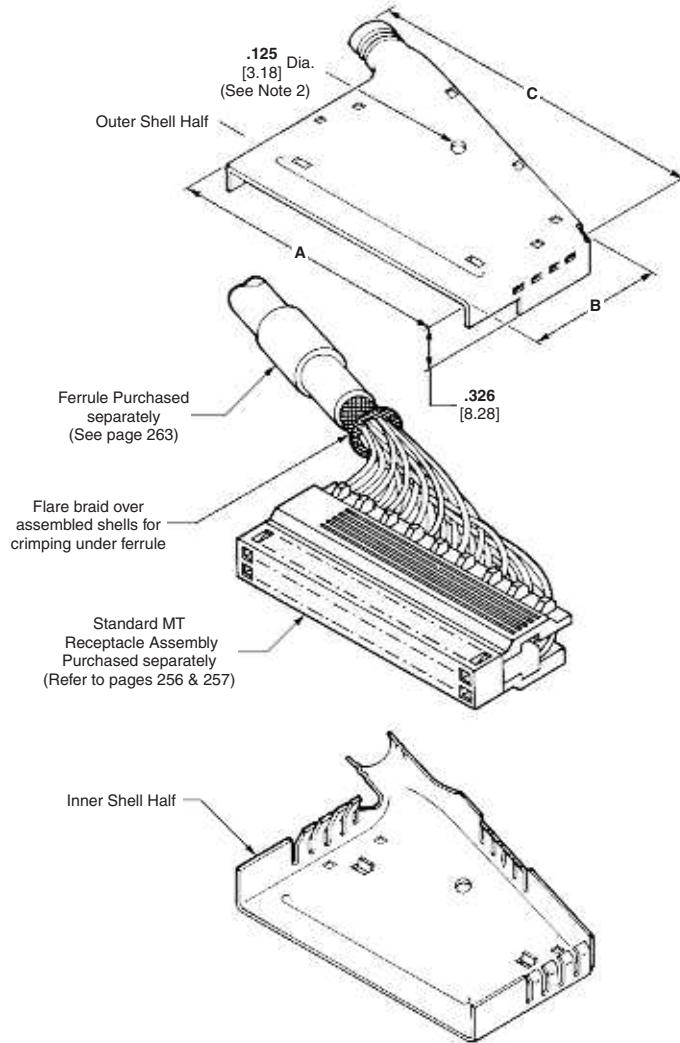

No. of Pos.	Dimensions			Part Nos.	
	A	B	C	Outer Shell	Inner Shell
18	1.010 [25.65]	1.120 [28.45]	1.413 [35.89]	102784-2	102783-2
26	1.410 [35.81]	1.166 [29.62]	1.975 [50.17]	103139-2	103138-2
40	2.110 [53.59]	1.135 [28.83]	2.633 [66.88]	102786-2	102785-2
50	2.610 [66.29]	.983 [24.97]	3.133 [79.58]	102788-2	102787-2
60	3.110 [78.99]	1.118 [28.40]	3.606 [91.59]	103141-2	103140-2

**Notes:** 1. Match shield size to number of connector positions.  
2. Hole is provided in 26 through 60-position cable shields for application of optional cable tie pull ring after assembly.

**Note:** All part numbers are RoHS compliant.

## Shielding Hardware and Accessories for Double-Row MT Receptacle Assemblies (Continued)

### Ferrules for Shielding Kits

#### Material and Finish

Soft copper, tin plated

#### Related Product Data

Used with Shielding Kits —  
pages 261, 262

#### Technical Documents —

pages 277, 278

#### Product Specification

108-25015, 108-25018, 108-25030

#### Application Specification

114-25032

#### Instruction Sheet

408-6532

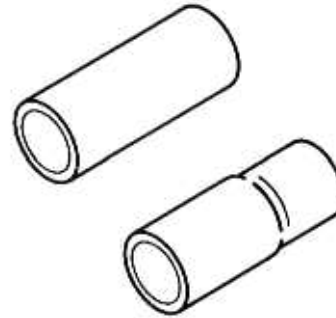

#### Application Tooling



AMP-O-LECTRIC Model "G" Terminating Machine



TE Hand Tool 91410-1 (Die Set required, see table below)

No. of Pos.	Straight-Exit Shields		Right-Angle Exit Shields		Cable Dia. Range	Ferrule Part Number	Applicator Die* Assembly Part No.	Hand Tool Die Sets	
	Outer	Inner	Outer	Inner				Insulation	Braid
6	102988-2	102987-6	—	—	0.200-0.250 [5.08-6.35]	102985-4	812665-2	1-527116-8	527116-4
					0.250-0.300 [6.35-7.62]	5-102903-2	812665-5	1-527116-6	527116-3
					0.310-0.360 [7.87-9.14]	5-102903-1	812665-4	1-527116-5	527116-3
10	103137-2	103136-2	—	—	0.370-0.420 [9.40-10.67]	5-102789-1	812665-3	1-527116-4	527116-3
					0.190-0.240 [4.83-6.10]	5-102903-3	812665-6	1-527116-7	527116-3
					0.250-0.300 [6.35-7.62]	5-102903-2	812665-5	1-527116-6	527116-3
16	103153-2	103152-2	—	—	0.310-0.360 [7.87-9.14]	5-102903-1	812665-4	1-527116-5	527116-3
					0.370-0.420 [9.40-10.67]	5-102789-1	812665-3	1-527116-4	527116-3
					0.190-0.240 [4.83-6.10]	5-102903-3	812665-6	1-527116-7	527116-3
18	—	—	102784-2	102783-2	0.250-0.300 [6.35-7.62]	5-102903-2	812665-5	1-527116-6	527116-3
					0.310-0.360 [7.87-9.14]	5-102903-1	812665-4	1-527116-5	527116-3
					0.370-0.420 [9.40-10.67]	5-102903-1	812665-3	1-527116-4	527116-3
26	103341-2	103340-2	103139-2	103138-2	0.320-0.370 [8.13-9.40]	5-102903-4	812665-9	1-527116-3	527116-2
					0.430-0.460 [10.92-11.68]	5-102789-2	812665-7	1-527116-1	527116-2
					0.320-0.370 [8.13-9.40]	5-102903-4	812665-9	1-527116-3	527116-2
40	104272-1	104271-1	102786-2	102785-2	0.430-0.460 [10.92-11.68]	5-102789-2	812665-7	1-527116-1	527116-2
					0.380-0.420 [9.65-10.67]	5-102903-6	1-812665-5	1-527116-2	527116-1
					0.430-0.460 [10.92-11.68]	5-102903-5	1-812665-4	1-527116-1	527116-1
50	103158-2	103157-2	102788-2	102787-2	0.470-0.520 [11.94-13.21]	5-102789-3	1-812665-3	1-527116-0	527116-1
					0.470-0.520 [11.94-13.21]	5-102903-8	1-812665-8	—	—
					0.500-0.545 [12.70-13.84]	5-102903-7	1-812665-7	—	—
60	—	—	103141-2	103140-2	0.550-0.600 [13.97-15.24]	5-102789-4	1-812665-6	—	—
					—	—	—	—	—

\*For use with Model "K" machines. Call the TE Technical Support Center (1-800-522-6752) for part nos. of applicators for use with the AMP-O-LECTRIC Model "G" machines (also shown on page 270), as well as other bench machines and fully automatic AMPOMATOR lead making machines.

- Notes:** 1. Ferrules are used with shielding kits shown on pages 261 & 262, and are purchased separately.  
2. Individual anvils and crimpers also may be purchased separately.  
3. Ferrule Part Number 1-102903-8 also requires Spacer Part Number 527116-9.

**Note:** All part numbers are RoHS compliant.

## Shielded MT Headers for use with Shielded MT Receptacle Assemblies

### AMPMODU Right-Angle Headers PC Board Mounted

#### Material and Finish

**Housing** — Black thermoplastic, flame retardant

**Posts** — Copper alloy, plated .000030 [0.00076] gold over .000050 [0.00127] nickel on entire post

**Shield** — Copper alloy, .020 [0.51] thick; pretinned .000030 [0.00076] min.

#### Related Product Data

**Mating Connectors** — Double-Row MT Receptacle Assemblies with Shielding Hardware — pages 256-263

**Technical Documents** — pages 277, 278

**Product Specification** 108-25015, 108-25018, 108-25030

**Application Specification** 114-25032.

**Instruction Sheet** 408-6532

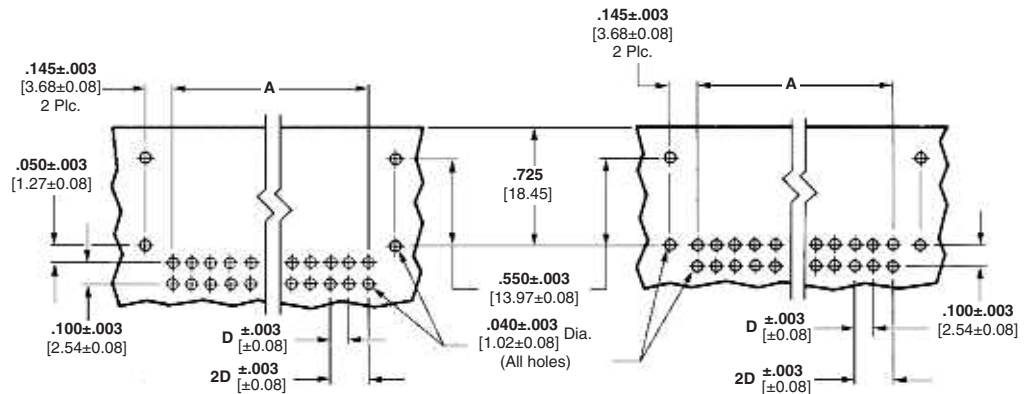
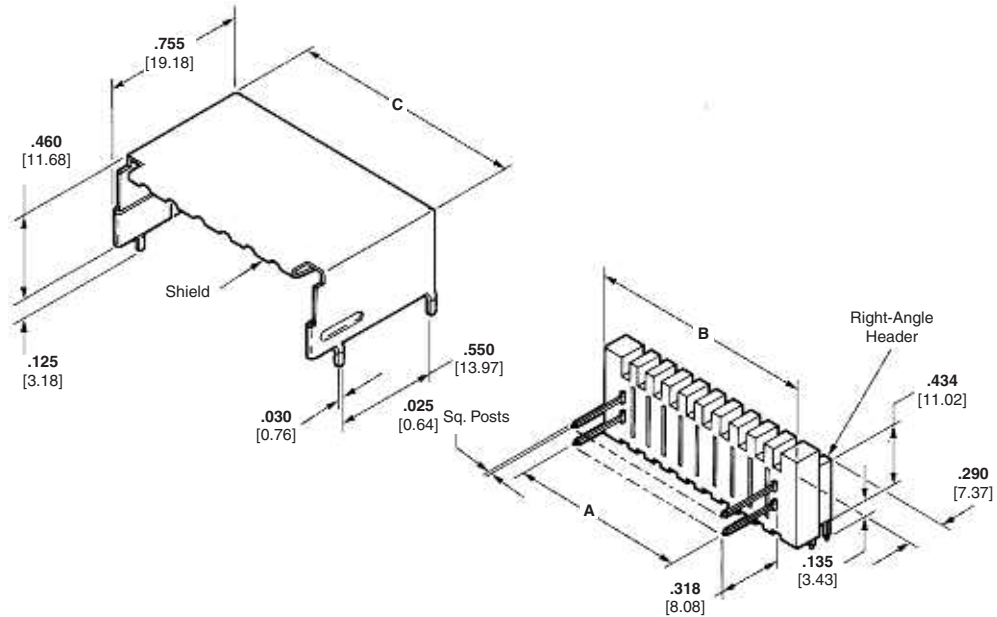

Recommended PC Board Hole Layout for 6, 8 and 10 Positions

Recommended PC Board Hole Layout for 16 thru 50 Positions

D - Contact centerline is .100 [2.54] ±.003 [0.08] tolerances not to accumulate within one connector pattern.

No. of Pos.	Dimensions			Header Part Nos.	Shield Part Nos.
	A	B	C		
6	.200 [5.08]	.430 [10.92]	.510 [12.95]	102792-6	102991-1
8	.300 [7.62]	.530 [13.46]	.610 [15.49]	102792-8	102991-2
10	.400 [10.16]	.630 [16.00]	.710 [18.03]	102792-1	102791-2
16	.700 [17.78]	.930 [23.62]	1.010 [25.65]	102792-7	102791-3
18	.800 [20.32]	1.030 [26.16]	1.110 [28.19]	102792-2	102791-4
20	.900 [22.86]	1.130 [28.70]	1.210 [30.73]	102792-5	1-102791-0
26	1.200 [30.48]	1.430 [36.32]	1.510 [38.35]	102792-9	102791-1
50	2.400 [60.96]	2.630 [66.80]	2.710 [68.83]	102792-4	102791-8

**Note:** All part numbers are RoHS compliant.



## Replacement MT Receptacle Contacts

### Insulation Displacement Contacts

#### Material and Finish

Copper alloy, duplex plated .000030 [0.00076] gold in mating area, .000100-.000200 [0.00254-0.00508] tin in crimp area, with entire contact underplated .000050 [0.00127] nickel

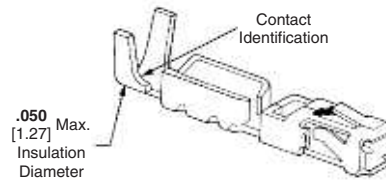

#### Related Product Data

**Performance Characteristics** — page 255

**Application Tooling** — pages 273-275

**Technical Documents** — pages 277, 278

**Product Specification**  
108-25015, 108-25018, 108-25030

**Application Specification**  
114-25032

**Instruction Sheet**  
408-6532

Wire Size Range		Standard Pressure Receptacle		High Pressure Receptacle	
AWG	[mm <sup>2</sup> ]	Contact Ident.	Part No.	Contact Ident.	Part No.
30-26	0.05-0.15	1	5-102395-2	4	5-102641-6
26-22	0.12-0.3	2	5-102399-1	5	5-102642-6
22-20	0.3-0.6	3	5-102449-6	—	—

**Note:** Termination tooling for MT receptacle insulation displacement contacts is shown on pages 273-275.

MT receptacle contacts incorporate the following features.

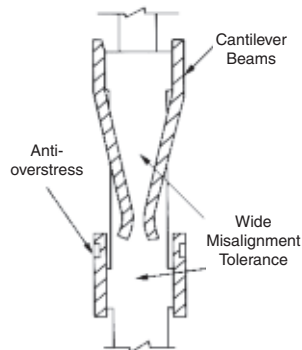

The MT receptacle contact cross-section is primarily rectangular, with rounded corners. Two integral cantilever beams contact the mating square male posts. Deflection of these spring members is limited by anti-overstress and excessive permanent deformation is prevented. This feature allows a wide range for tolerance of misalignment of mating contacts.

The configuration of the receptacle completely encloses the spring members helping to prevent damage during handling and assembly, and makes the system compatible with automatic application techniques.





**Extraction/Lance Reset Tool  
No. 843477-3**

**Note:** All part numbers are RoHS compliant.

## Mini-Tandem Spring Receptacle Housings and Contacts

### Product Facts

- Individual contacts mate with .025 [0.64] sq. posts, .125 [3.18] long
- Crimp snap-in contacts accept 32-22 AWG [0.03-0.32 mm<sup>2</sup>] wire
- Retention latch provides for positive installation
- No insertion tool required
- High durability design provides long life
- Available with .000015 [0.00038] or .000030 [0.00076] thick gold inlay in contact areas, or bright tin plated
- Closed-entry housings
- Mini-contact box size: .060 [1.52] sq.
- Mini-Tandem Spring Housings can be stacked on .100 [2.54] centers in either direction
- Mini-Tandem Spring Housings are Recognized under the Component Program of Underwriters Laboratories Inc.,  File No. E28476
- Certified by Canadian Standards Association,  File No. LR 7189

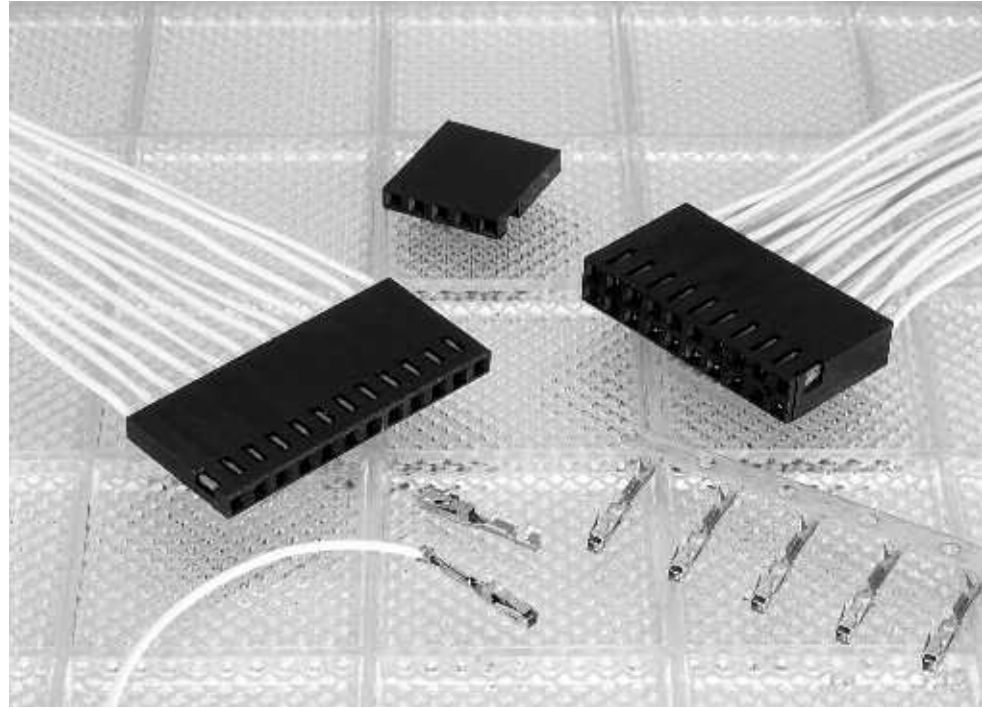

Mini-Tandem Spring Receptacle Contacts are designed to mate with .025 [0.64] posts. When used individually, they will mate with posts as short as .125 [3.18] and when used in a housing, they will mate with .140 [3.55] long posts. These versatile contacts may be used for interconnecting posted pc panels, I/O wiring and cross-connecting pin arrays.

The receptacle contact's box configuration provides for long contact life with controlled contact mating forces which minimize wear. An external retention spring facilitates quick assembly and provides firm seating in a contact housing.

Mini-Tandem Spring Receptacle Contacts are used in single- or double-row housings with .100 [2.54] centerline spacing. Single-row housings can be converted into double-row connectors on .100 x .200 [2.54 x 5.08] centers with the use of stacking clips.

Mini-Tandem Spring Housings can be stacked side-by-side or end-to-end on .100 [2.54] centers.

### Specifications

**Contact Current Rating** — 3 amperes

**Termination Resistance** — 12 milliohms (max.) — gold plated contacts  
18 milliohms (max.) — tin plated contacts

**Durability** — Ref. Product Specification 108-25031

## Mini-Tandem Spring Housings, Single-Row

### .100 [2.54] Centerline



**Material** — Black glass-filled polyester, 94V-0 rated

**Technical Documents** — pages 277, 278

**Product Specification**  
108-25031

**Application Specification**  
114-25021

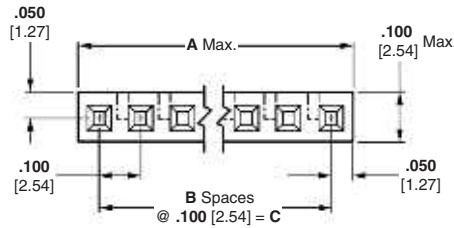
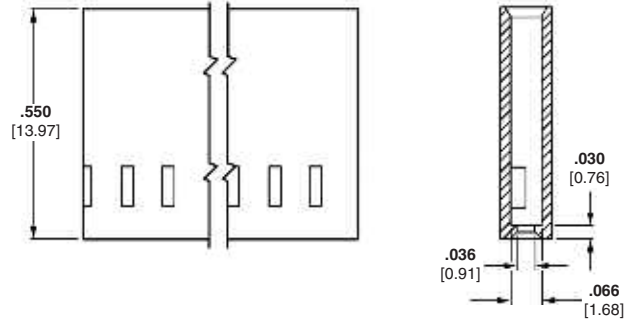

Minimum mating post length is .140 [3.55].

**Material**—Natural color nylon, 94V-2 rated

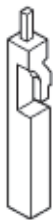

**Keying Plug**  
**Part No. 531226-1**  
(Plugs directly into housing)

**Note:** Mini-Tandem Spring contacts for use in these housings are shown on page 269.

No. of Pos.	Dimensions			Housing Part No.
	A	B	C	
2	.200 [5.08]	1	.100 [2.54]	530554-1
4	.400 [10.16]	3	.300 [7.62]	530554-3
8	.800 [20.32]	7	.700 [17.78]	530554-7
12	1.200 [30.48]	11	1.100 [27.94]	1-530554-1
16	1.600 [40.64]	15	1.500 [38.10]	1-530554-5
18	1.800 [45.72]	17	1.700 [43.18]	1-530554-7
20	2.000 [50.80]	19	1.900 [48.26]	1-530554-9
22	2.200 [55.88]	21	2.100 [53.34]	2-530554-1

**Note:** All part numbers are RoHS compliant.

## Mini-Tandem Spring Housings, Double-Row

### .100 [2.54] Centerline



**Material** — Black glass-filled polyester, 94V-0 rated\*

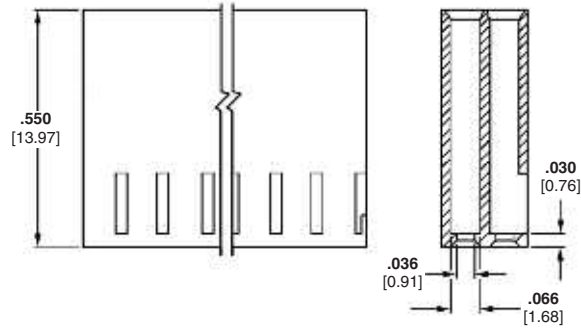

**Technical Documents** —  
pages 277, 278

**Product Specification**  
108-25031

**Application Specification**  
114-25021

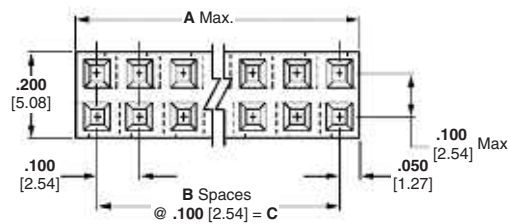

Minimum mating post length is .140 [3.55].

Mini-Tandem Spring Contacts

5

**Material** — Natural color nylon, 94V-2 rated



**Keying Plug**  
Part No. 531226-1  
(Plugs directly into housing)

No. of Pos.	Dimensions			Housing Part No.
	A	B	C	
6	.300 [7.62]	2	.200 [5.08]	530902-1
8	.400 [10.16]	3	.300 [7.62]	530902-6
12	.600 [15.24]	5	.500 [12.70]	2-530902-0
16	.800 [20.32]	7	.700 [17.78]	3-530902-0

**Note:** Mini-Tandem Spring contacts for use in these housings are shown on page 269.

\*Consult TE for specific UL recognition.

**Note:** All part numbers are RoHS compliant.

## Mini-Tandem Spring Contacts

### Receptacle Contacts

#### Material and Finish

Phosphor bronze, plated as follows:  
**Plating A** — Duplex plated .000030 [0.00076] gold inlay on contact area, matte tin in crimp area, with entire contact underplated .000050 [0.00127] nickel  
**Plating B** — Duplex plated .000015 [0.00038] gold inlay on contact area, matte tin in crimp area, with entire contact underplated .000050 [0.00127] nickel  
**Plating C** — Duplex plated .000050 [0.00127] over matte tin in contact area, over .000030 [0.00076] nickel on entire contact  
**Plating D** — .000100 [0.00254] min. matte tin over .000030 [0.00076] nickel on entire contact

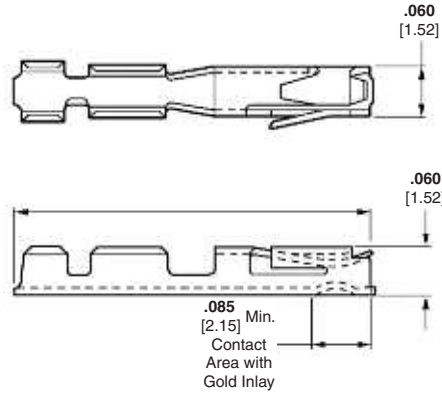

#### Technical Documents — pages 277, 278

**Product Specification**  
108-25031

**Application Specification**  
114-25021

#### Low Pressure Contacts

Wire Size Range AWG	mm <sup>2</sup>	Ins. Dia. Range	Finish	Contact Part No.		Miniature Applicator for AMP-O-LECTRIC Machine*	Applicator for AMP-O-MATIC Stripper/Crimper Machine
				Strip Form	Loose Piece		
26-22	0.14-0.32	.036-.054 [0.64-1.37]	Plating A	5531216-3	5531216-4	466819-2	466943-1
			Plating B	5531216-1	5531216-2		

#### Standard Pressure Contacts

Wire Size Range AWG	mm <sup>2</sup>	Ins. Dia. Range	Finish	Contact Part No.		Miniature Applicator for AMP-O-LECTRIC Machine*	Applicator for AMP-O-MATIC Stripper/Crimper Machine
				Strip Form	Loose Piece		
32-28	0.03-0.08	.025-.054 [0.64-1.37]	Plating B	530901-2	530901-3	466723-1	466952-1
			Plating C	5530901-6	5530901-7		
			Plating D	5530901-4	5530901-5		
26-22	0.14-0.32	.036-.054 [0.91-1.37]	Plating B	5530553-4	—	466819-2	466943-1
			Plating C	5530553-6	—		
			Plating D	5530553-2	—		

#### High Pressure Contacts

Wire Size Range AWG	mm <sup>2</sup>	Ins. Dia. Range	Finish	Contact Part No.		Miniature Applicator for AMP-O-LECTRIC Machine*	Applicator for AMP-O-MATIC Stripper/Crimper Machine
				Strip Form	Loose Piece		
32-28	0.03-0.08	.025-.054 [0.64-1.37]	Plating B	5531225-6	—	466723-1	466952-1
26-22	0.14-0.32	.036-.054 [0.91-1.37]	Plating B	5531224-6	—	466819-2	466943-1

\*For use with AMP-O-LECTRIC Model "K" machines. Call the Tooling/Technical Assistance Center (1-800-522-6752) for part nos. of applicators for use with the AMP-O-LECTRIC Model "G" machines (shown on page 270), as well as other bench machines and fully automatic AMPOMATOR lead making machines.

- Notes:**
1. Mini-Tandem Spring Receptacle Contacts are for use only in the housings shown on pages 267 & 268. They cannot be used in AMPMODU Mod IV Housings.
  2. Use Hand Tool No. 91540-1 for crimping loose-piece receptacles to all wire sizes listed above.
  3. Application tooling is described on pages 270 & 275.

**Note:** All part numbers are RoHS compliant.

## Application Tooling for Wire Crimp Contacts

Tooling shown on this page is designed to terminate wire crimp contacts used in various AMPMODU wire-to-board connectors. Refer to page 88 to determine the applicable connectors.

### AMP-O-LECTRIC Model "G" Terminating Machine (Shown with Optional Crimp Force Monitor)

A totally new design of our most popular machine for bench-top operation. It features a quiet and reliable direct motor drive, electronic controls for easy setup and operation, and improved guarding and lighting for operator convenience and safety. All versions include either manual or automatic precision adjustment for crimp height.

For further details, request TE Catalog 65828.



### AMP-O-MATIC Stripper/Crimper Machine

#### Applicators

Several terminating machines, including the AMP-O-LECTRIC Model "G", AMP-O-MATIC Stripper/Crimper and AMPOMATOR CLS machines, are designed for use with interchangeable applicators. Basic styles are quickly interchangeable to minimize costly downtimes, and feature dial-in wire and insulation crimp height settings. Special applicators are available for use with the Crimp Force Monitor (see page 272), for measuring the crimp height of each termination as it is made, plus evaluating the quality of each crimp.



This machine automatically strips as well as terminates individual wires. Similar to the AMP-O-LECTRIC Model "G" machine, applicators are quickly interchangeable, and it includes precision adjustment for crimp height. All adjustments can be made from the front of the machine, without special tools.

For further details, request TE Catalog 65004.



#### Heavy Duty Miniature Applicators



#### EDGE, Electronic Applicator Counter

The new versatile EDGE applicator counter tracks wearable tool usage for the most effective maintenance planning. The completely electronic counter with clear LCD display, indicates cycles since installation. By performing maintenance at measured intervals with pre-set limits, operators avoid breakdowns and rejects caused by tool wear or mid-adjustment. For more information, request catalog 1773385.

## Application Tooling for Wire Crimp Contacts (Continued)

### AMP 3K/40 and AMP 5K/40 Terminators

As a value oriented terminator, the AMP 3K/40 and AMP 5K/40 are designed for customers that require the increased output and quality of a semiautomatic machine at a competitive price. By incorporating the most commonly requested features as standard and offering a long list of optional equipment, these terminators offer flexibility to meet the specific needs of various applications at the lowest possible cost.



AMP 5K/40 Terminator

### Optional Stripping Module for the AMP 3K/40, AMP 5K/40 and the AMP-O-LECTRIC Model G

The combination of the Stripping Module with the AMP-O-LECTRIC Model G Terminator or the AMP 3K/40, 5K/40 provides an economical, proficient method of stripping wire and crimping terminals on the same machine. Wires are stripped moments before crimping, meaning there is virtually no chance of damaging wire conductors during handling or storage. Once the wire is fed into the start sensor, the Stripping Module does the rest, improving placement accuracy. For more information, request catalog 1309085.

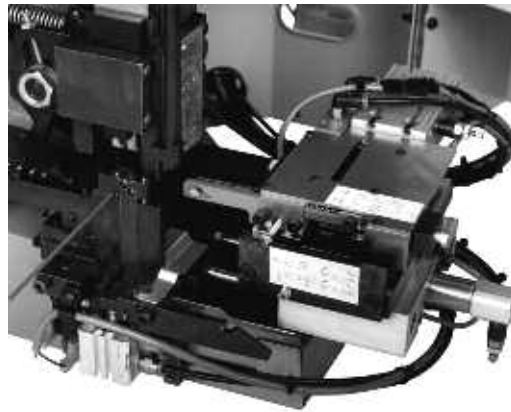

## Application Tooling for Wire Crimp Contacts (Continued)

Tooling shown on this page is designed to terminate wire crimp contacts used in various AMPMODU wire-to-board connectors. Refer to page 88 to determine the applicable connectors.

### Crimp Force Monitor (CFM)



Your quality program calls for more than a good crimping system. It demands proof - the proof you get with the SLE Crimp Force Monitor. It has high-resolution piezo-quartz sensor technology for a more precise identification of typical crimping faults. The monitor features Zone & Peak Force Analysis, 128x128 Dot Matrix, Force Trigger and Encoder Proximity Trigger, and Absolute Force Measurement for real-time monitoring of every crimp. The CFM can be used with bench or fully-automatic machines. Special applicators are not required.

Sure, you can sample and test crimp height with a micrometer. In fact, that's how you standardize your process. But for ongoing quality control, testing every crimp, SLE is the choice. It's known worldwide, and meets our standards for a high performance terminating system. That's how you can be sure.

High quality crimping - with verification - means higher production and productivity.

### AMPOMATOR System III Leadmaker



The AMPOMATOR System III is an automatic machine for the production of terminated wire leads. The machine combines state of the art technology to process single and double wire application utilizing the wire processing industry's best and most friendly subsystems and accessories available to meet the latest market requirements for wire lead production.

The new machine incorporates a servo-driven, software-controlled AMP-O-LECTRIC ST III terminator and the next generation System III Applicator.

See catalog 1654956-5 for more information.



### Commercial PRO-CRIMPER III Hand Tool



Commercial grade hand tool for crimping various products. Features ratchet control to provide complete crimp cycle. Accepts both pinned- and shouldered-style die sets. Locators are provided with pinned-style die sets for proper contact and wire positioning, and to help minimize contact rotation and bending during crimping. Approximate weight 1.3 lb [0.60 kg].

### Premium CERTI-CRIMP Straight Action Hand Tool (SAHT)



TE hand tools are ideal for small production and prototype applications. They feature ratchet control to help eliminate partial crimps,

straight-line die closure, terminal locator and support, and insulation crimp adjustment. TE hand tools also can be adapted for use with pneumatic tooling assemblies, providing air operated crimping capabilities.

For further details on TE straight action hand tools, request TE Catalog 65780. For more details on TE pneumatic tooling assemblies, call the TE Technical Support Center, 1-800-522-6752.





## Application Tooling for Insulation Displacement Crimp (IDC) Contacts and Connectors

Tooling shown on this page is designed to terminate IDC contacts for various AMPMODU wire-to-board connectors. Refer to page 88 to determine the applicable connectors.

### Pistol Grip Manual and Air Powered Tools

The manual pistol grip tool features an interchangeable modular terminating head which also can be used in the pneumatic version, the Bench Mount Pneumatic Power Assembly and the IDC Electric Power Unit. The head terminates one unstripped wire per cycle and indexes the connector to the next terminating position. The head rotates to permit optimum access to the wiring area.

The Bench Mount Pneumatic Power Assembly is air actuated with either a foot or knee switch. This capability frees the operator's hands for optimum positioning.

#### Modular Heads:

- 58062-1** (for MT connectors)
- 58336-1** (for MTE connectors)
- 58395-1** (for Level V IDC connectors)
- 58540-1** (for MTE connectors, discrete wire or flat ribbon cable)



Manual Pistol Grip  
Tool No. 58074-1



Pneumatic Pistol Grip  
Tool No. 58075-1



Bench Mounted Pneumatic Power Assembly  
No. 58338-1

### Modular Head Tool No. 58540-1



This modular head tool can be used on any pistol grip tool. It was designed for discrete wire or flat ribbon cable applications.



IDC Electric Power Unit  
No. 931800-1

### IDC Electric Power Unit

This electrically powered semiautomatic bench machine is designed for applying AMPMODU MTE and MT connectors to discrete wires. It is portable and compact and uses existing pistol grip modular heads. The heads are easily interchanged to run different products. \*The IDC Electric Power Unit's cycle rate is approximately 7,200 cycles per hour, with exact production rates depending upon operator dexterity.

#### Modular Heads:

- 58062-1** (for MT connectors)
- 58336-1** (for MTE connectors)

\*A tube-fed track assembly, Part No. 856675-1, also can be used with MTE Connectors.

**Note:** All part numbers are RoHS compliant.

## Application Tooling for Insulation Displacement Crimp (IDC) Contacts and Connectors (Continued)

Tooling shown on this page is designed to terminate IDC contacts for various AMPMODU wire-to-board connectors. Refer to page 88 to determine the applicable connectors.

### Tube-Fed Ribbon Cable Machine



**Tube-Fed Ribbon Cable Machine No. 856002-1**

Designed for bench applications, this machine is pneumatically operated and controlled by a foot pedal. It terminates connectors onto end-notched ribbon cable. \*The connectors are supplied in strip form and in plastic tubes. The machine consists of three basic sub-assemblies: a feed track, a terminating station and a seating station. The feed track is a constant force,

spring-driven unit which conveys connectors through the product tube to the terminating station. The air-operated terminating station positions and terminates contacts onto the notched cable. The seating station is manually operated and seats connector housings onto the terminated contacts.

\*At a rate of 13-25 positions at a time.

### 2700 lb. Power Unit With Cable Notching Die



**2700 lb. Power Unit No. 312522-1**

Equipped with a cable notching die an adapter kit, this fully pneumatic bench machine provides the 2700 lb [12 010N] force required for end-notching ribbon cable. It features a grooved cable support plate, a pressure plate and a cable stop to facilitate cable alignment and positioning during the notching process.

#### Notching Dies:

**854449-1** (for 24-22 AWG [0.2-0.6 mm<sup>2</sup>] Wire)

**854449-2** (for 28-26 AWG [0.08-0.15 mm<sup>2</sup>] Wire)

**Note:** All part numbers are RoHS compliant.

## Application Tooling for Insulation Displacement Crimp (IDC) Contacts and Connectors (Continued)

Tooling shown on this page is designed to terminate IDC contacts for various AMPMODU wire-to-board connectors. Refer to page 88 to determine the applicable connectors.

### CHAMPOMATOR Model 2.5 Terminating Machine No. 354786-(\* )



This compact bench machine terminates wires manually sorted from multiconductor cables. Termination sequence may include full termination of all contacts, or selective termination. Designed for easy programming, the machine is microprocessor controlled

and programmed by a membrane switch keyboard. It also has an internal storage capability for retaining up to 350 cable assemblies. Connectors can be terminated with either straight or right-angle wire dress.

\*For applicable dash nos., call the Technical Support Center: 1-800-522-6752. For further details, request TE Catalog 82247

### CHAMPOMATOR Model 3A Terminating Machine No. 761420-(\* )



This floor model machine automatically sorts wires from multiconductor jacketed cable and terminates them in a user-determined sequence; either full termination of all contacts, or selective termination. Designed for easy programming, the machine is microprocessor

controlled and programmed by a touchscreen. It also has an internal storage capability for retaining up to 50 cable assemblies. Connectors can be terminated with either straight or right-angle wire dress. All cable assemblies are tested for continuity and shorts.

\*For applicable dash nos., call the Technical Support Center: 1-800-522-6752. For further details, request TE Catalog 82247

**Note:** All part numbers are RoHS compliant.

## Technical Documents for Board-to-Board Products

Various technical documents are available for your use.

**Product Specifications** describe technical performance characteristics and verification tests. They are intended for the Design, Component and Quality Engineers.

**PC/104 and PC/104-Plus Connectors — Pages 5-12:**

108-1956 PC/104 and PC/104-Plus Connector Systems

**Receptacle Assemblies and Unshrouded Breakaway Headers, Surface-Mount — Pages 109, 110, 185-192:**

108-25017 AMPMODU Interconnection System, Two-Piece

108-25022 AMPMODU Mod. IV Interconnection System, Vertical Assemblies

108-25026 AMPMODU Mod. II Interconnection System, Standard Pressure Receptacle Assembly and Header

**Two-Piece Printed Circuit Board Connectors — Pages 193-202:**

108-16 ACTION PIN Contacts

108-25017 AMPMODU Interconnection System, Two-Piece

108-25027 AMPMODU Mod. II Interconnection System, Short-Point Receptacle Assembly and Header

**Receptacle Assemblies, Horizontal and Vertical Board Mount — Pages 168-192:**

108-25022 AMPMODU Mod. IV Interconnection System, Vertical Assemblies

108-25026 AMPMODU Mod. II Interconnection System, Standard Pressure Receptacle Assembly and Header

108-25027 AMPMODU Mod. II Interconnection System, Short-Point Receptacle Assembly and Header

**.025 [0.64] Square Posts, Headers, Accessories and Tooling — Pages 92-105, 114-140, 145-153, 163:**

108-16 ACTION PIN Contacts

108-25026 AMPMODU Mod. II Interconnection System, Standard Pressure Receptacle Assembly and Header

**Application Specifications** describe requirements for using the product in its intended application, and/or crimping information. They are intended for the Packaging and Design Engineers and the Setup person.

**PC/104 and PC/104-Plus Connectors — Pages 5-12:**

114-13021 PC/104 and PC/104-Plus Connectors

**Two-Piece Printed Circuit Board Connectors — Pages 193-202:**

114-9009 AMPMODU Header, Two-Piece, Double Row, Application of

**Receptacle Assemblies, Horizontal and Vertical Board Mount — Pages 168-192:**

114-25018 AMPMODU Mod. II and IV Receptacle Assembly, PC Board Mounted, Vertical, Application of

**.025 [0.64] Square Posts, Headers, Accessories and Tooling — Pages 92-105, 114-140, 145-153, 163-167:**

114-25028 ACTION PIN Contacts with TE Headers, Application

114-13011 AMPMODU .025 and .045 Square Continuous Posts

**Instruction Sheets** provide instructions for assembling or applying the product. They are intended for the Manufacturing Assembler or Operator.

**PC/104 and PC/104-Plus Connectors — Pages 5-12:**

408-8502 Future Board Assembly 1424685 for PC/104 and PC/104-Plus Connectors

408-8503 Seating Tool Assembly 1424686 for PC/104 and PC/104-Plus Connectors

408-8504 Pneumatic Seating Tool Assembly 1424930-1 for PC/104 and PC/104-Plus Connectors

408-8505 Manual Seating Tool Assembly 1424931-1 for PC/104 and PC/104-Plus Connectors

**Two-Piece Printed Circuit Board Connectors — Pages 193-202:**

408-2636 ACTION PIN Contact Rear Insertion/Extraction Tool 265871-7

408-9054 Seating Tools

**Receptacle Assemblies, Horizontal and Vertical Board Mount — Pages 168-192:**

408-7411 Suggestions for Wave Soldering Vertical AMPMODU Receptacles

**.025 [0.64] Square Posts, Headers, Accessories and Tooling — Pages 92-105, 114-140, 145-153, 163:**

408-2636 ACTION PIN Contact Rear Insertion/Extraction Tool 265871-7

408-6944 TE Uninsulated Bandolier Post Insertion Tool 91419-1

408-7977 AMPMODU Double Row, Straight Posts, End Shrouds .100 x .100 [0.64 x 0.64] Centers

408-7878 AMPMODU Header Barrier Inserts

408-9054 ACTION PIN Contact Headers Seating Tool, 91170 Series

408-9707 Tool Kit 314818-1 for Breakaway Headers

**Handbook**  
5697

**Guide to Application of ACTION PIN Contact Connectors**

**Note:** All part numbers are RoHS compliant.

---

## Technical Documents for Wire-to-Board Products

---

Various technical documents are available for your use.

**Product Specifications** describe technical performance characteristics and verification tests. They are intended for the Design, Component and Quality Engineers.

**Locking Clip Contacts and Housings — Pages 206-209:**

- 108-36028 Connector, Locking Clip, .025 [0.64] Square, Gold
- 108-36028-1 Connector, Locking Clip, .025 [0.64] Square, Tin

**Mod. IV Wire-Applied Contacts and Housings — Pages 210-220:**

- 108-25007 AMPMODU Mod. V Interconnection System, Wire-Applied (High Pressure)
- 108-25019 AMPMODU Mod. IV Male Connectors
- 108-25020 AMPMODU Mod. IV Interconnection System, (Standard Pressure)
- 108-25021 AMPMODU Mod. IV.V Interconnection System, (Intermediate Pressure)

**Short-Point Wire-Applied Contacts and Housings — Pages 221-224:**

- 108-1472 Short-Point Contacts and Housings

**AMPMODU MTE Interconnection System — Pages 225-252:**

- 108-25034 AMPMODU MTE Connectors

**AMPMODU MT and Shielded MT Interconnection System — Pages 255-265:**

- 108-25015 AMPMODU MT Standard Pressure Connectors
- 108-25018 AMPMODU MT High Pressure Connectors
- 108-25030 AMPMODU MT Shielding Accessories

**AMPMODU Level V, IDC Connectors —**

- 108-25028 Interconnection System, Insulation Displacement Connector, IDC Level

**Mini-Tandem Spring Receptacle Contacts — Pages 266-269:**

- 108-25031 Tandem Spring Receptacle Contact

---

**Application Specifications** describe requirements for using the product in its intended application, and/or crimping information. They are intended for the Packaging and Design Engineers and the Setup person.

**Locking Clip Contacts and Housings — Pages 206-209:**

- 114-25006 Contact, Locking Clip, .025 [0.64] Square, Application of

**Mod. IV Wire-Applied Contacts and Housings — Pages 210-220:**

- 114-25003 AMPMODU Mod. IV (Standard Pressure), AMPMODU Mod. IV.V (Intermediate Pressure) and AMPMODU Mod. V (High Pressure) Receptacle Contacts, Application of
- 114-25016 AMPMODU Mod. IV Crimp Pin Contact

**Short-Point Wire-Applied Contacts and Housings — Pages 221-224:**

- 114-25038 Short-Point Contacts and Housings

**AMPMODU MTE Interconnection System — Pages 225-252:**

- 114-25026 AMPMODU MTE Interconnection System

**AMPMODU MT and Shielded MT Interconnection System — Pages 255-265:**

- 114-25032 AMPMODU MT Interconnection System and Shielding Accessories, Application of

**AMPMODU Level V, IDC Connectors —**

- 114-25020 Interconnection System, IDC Level V, Application of

**Mini-Tandem Spring Receptacle Contacts — Pages 266-269:**

- 114-25021 Tandem Spring Receptacle Contact, Application of

**Note:** All part numbers are RoHS compliant.

**Technical Documents for Wire-to-Board Products** (Continued)

**Instruction Sheets** provide instructions for assembling or applying the product. They are intended for the Manufacturing Assembler or Operator.

**Locking Clip Contacts and Housings — Pages 206-209:**

408-7604	TE Extraction Tool 91084-1
408-7606	TE Locking Clip Contacts and Connectors
408-7627	TE Hand Crimp Tool 90295-1, 28-30 AWG Wire
408-8547	TE Hand Crimp Tool 91533-1, 22-26 AWG Wire
408-9388	TE Hand Crimp Tool 90431-1, 20 AWG Wire

**Mod. IV Wire-Applied Contacts and Housings — Pages 210-220:**

408-4379	TE PRO-CRIMPER II Hand Tool
408-7935	AMPMODU Receptacle Connectors with Strain Relief/Pull Tabs
408-8547	TE Hand Tool 91516-1, 91517-1 and 91541-1
408-9451	TE Extraction Tool 843473-1 for AMPMODU Wire-Applied Housings 86308
408-9453	TE Extraction Tools 843996 and 843477 for Removing AMPMODU Crimp Snap-In Receptacle Contacts from Wire-Applied Housings

**AMPMODU MTE Interconnection System — Pages 225-252:**

409-5746	TE Electric Power Unit 931800-1
409-5832	MTE Ribbon Cable Terminator 856002-1
408-6789	TE Pneumatic Pistol Handle 58075-1
408-6790	TE Manual Pistol Handle 58074-1
408-6919	AMPMODU MTE Connectors
408-8547	TE Hand Crimp Tool 91518-1 and 91551-1
408-9230	TE Keying Tool 91417-1
408-9359	MTE Modular Terminating Head 58336-1
408-9393	TE Pneumatic Bench Assy. 58338-1
408-9407	TE Hand Crimp Tool 91531-1 and 58342-2
408-9453	TE Extraction Tools 843996 and 843477 for Removing AMPMODU Crimp Snap-In Receptacle Contacts from Wire-Applied Housings
408-9515	Ribbon Cable Notcher 854449-[]

**AMPMODU MT and Shielded MT Interconnection System — Pages 255-265:**

408-6532	AMPMODU MT Connectors
----------	-----------------------

**AMPMODU Level V, IDC Connectors —**

408-6843	TE Extraction Tool 91409-1
----------	----------------------------



**Standard Tandem Spring and Mini-Tandem Spring Receptacle Contacts — Pages 266-269:**

408-7909	TE Hand Crimping Tool 91540-1
----------	-------------------------------

**Note:** All part numbers are RoHS compliant.

## Level V IDC Connectors, .125 x .125 [3.18 x 3.18] Centerline

### Product Facts

- Termination of discrete wire sizes 26-22 AWG [0.12-0.3 mm<sup>2</sup>] as well as jacketed cable and bonded ribbon cable (conductors separated)
- Connectors stackable end-to-end and side-to-side on .125 [3.18] centers
- Connectors preloaded with insulation displacement receptacle contacts
- Contact design employs dual cantilever beams, redundant insulation displacement slots, built-in post stop and wire support crimp
- Copper alloy contacts are duplex plated
- Snap-on covers with or without cable tie paddles
- Full line of mass termination tooling offers lowest installed costs for most production needs
- Recognized under the Component Program of Underwriters Laboratories Inc.,  File No. E28476
- Certified by Canadian Standards Association,  File No. LR 7189

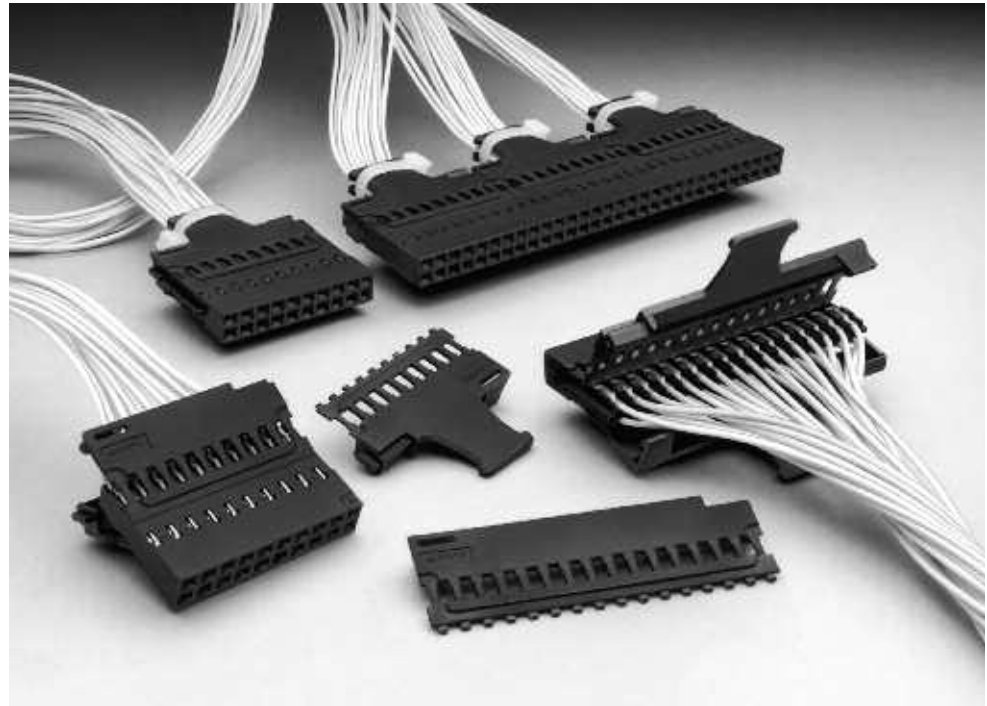

AMPMODU Level V IDC connectors provide cost effective discrete wire connections that are compatible with today's telecommunications packaging techniques. These connectors are designed to mate with .025 [0.64] sq. posts on .125 x .125 [3.18 x 3.18] centers and are comprised of double-row housings preloaded with insulation displacement receptacle contacts, snap-on hermaphroditic covers, and a full line of mass termination tooling to meet virtually every production need. For modular flexibility, connectors can be stacked end-to-end or side-to-side, maintaining a .125 x .125 [3.18 x 3.18] centerline spacing.

Covers can be furnished with and without a cable tie paddle. The covers are simply snapped onto a housing after the connector has been terminated.

The receptacle contacts feature the TE insulation displacement crimp technique for achieving top quality, low cost terminations. These contacts employ dual cantilever beams for redundant interface with a mating post, an integral post stop to limit post mating depth and protect the crimp termination, and a wire support (strain relief) crimp to prevent accidental wire pull-out. The contacts are made of high conductivity copper alloy and are duplex plated.

### Performance Characteristics

**Contact Current Rating** — 3 amperes

**Termination Resistance** — 12 milliohms (max.)

**Durability** — Ref. Product Specification 108-25028 (Interconnection System, Insulation Displacement Connector, IDC Level)

**Application Specification** 114-25020 (Interconnection System, IDC Level V, Application of)

**Receptacle Assemblies, Double-Row, .125 x .125 [3.18 x 3.18] Centerline**

**Housings Preloaded with Insulation Displacement Crimp Receptacle Contacts**



**Material and Finish**

**Housing** — Black thermoplastic, flame retardant

**Contacts** — Copper alloy, duplex plated .000050 [0.00127] gold on contact area, .000100 [0.00254] min. tin in crimp area, with entire contact underplated .000050 [0.00127] nickel

**Note:** Preloaded contacts accept max. insulation dia. of .050 [1.27]. The minimum point of contact, as measured from front edge of housing, is .095 [2.41].

**Technical Documents** — pages 277, 278

**Product Specification**  
108-25028

**Application Specification**  
114-25020

Receptacle assemblies can be stacked end-to-end and side-to-side on .125 x .125 [3.18 x 3.18] centers.

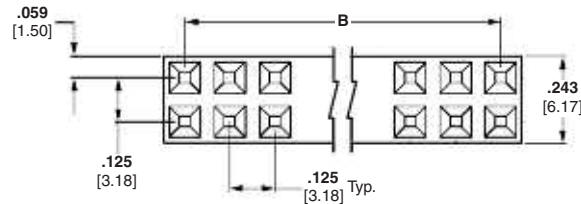
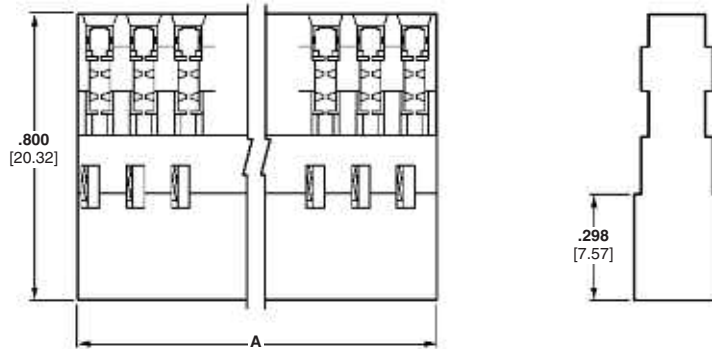

No. of Pos.	Dimensions		Receptacle Assembly (Stamped <sup>1</sup> ) for 26-22 AWG [0.12-0.3 mm <sup>2</sup> ] Wire
	A	B	
8	.493 [12.52]	.375 [9.52]	102935-4
10	.618 [15.70]	.500 [12.70]	102935-6
12	.743 [18.87]	.625 [15.88]	102935-8
16	.993 [25.22]	.875 [22.23]	1-102935-2
20	1.243 [31.57]	1.125 [28.58]	1-102935-6
24	1.493 [37.92]	1.375 [34.93]	1-102935-9
30	1.868 [47.45]	1.750 [44.45]	1-102935-3
32	1.993 [50.62]	1.875 [47.63]	2-102935-8
40	2.493 [63.32]	2.375 [60.33]	3-102935-6

<sup>1</sup>White ink stamped, one side—8- thru 12-position with AMP and arrow; 14- and 16-position with AMP, part no., and arrow; 18- thru 40-position with AMP, part no., date code and arrow.

- Notes:**
- Covers for these housings are shown on pages 281 & 282.
  - Termination tooling for these connectors are shown on page 273-275.
  - 14- and 18-position receptacle assemblies, as well as other sizes, can be made available upon request. Consult TE.

**Note:** All part numbers are RoHS compliant.

.125 [3.18] x .125 [3.18] Centerline

6



## Hermaphroditic Covers for Level V IDC Receptacle Assemblies, Double-Row, .125 x .125 [3.18 x 3.18] Centerline

All covers illustrated here and on the following page can be used on the double-row Level V IDC connectors shown on page 280.

### Material

Black thermoplastic, flame retardant, 94V-0 rated

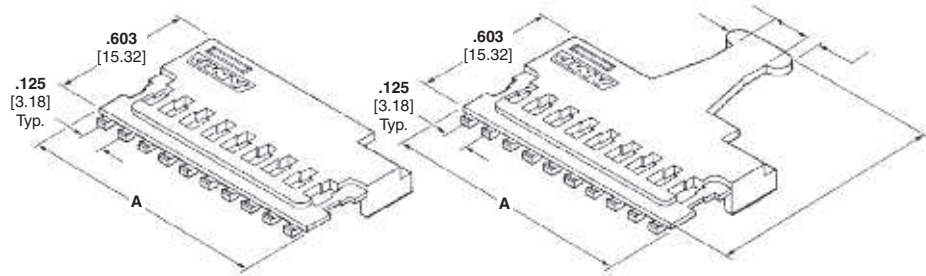

**Cover 103056 Series**  
without Cable Tie Paddle

**Cover 103058 Series**  
with Cable Tie Paddle

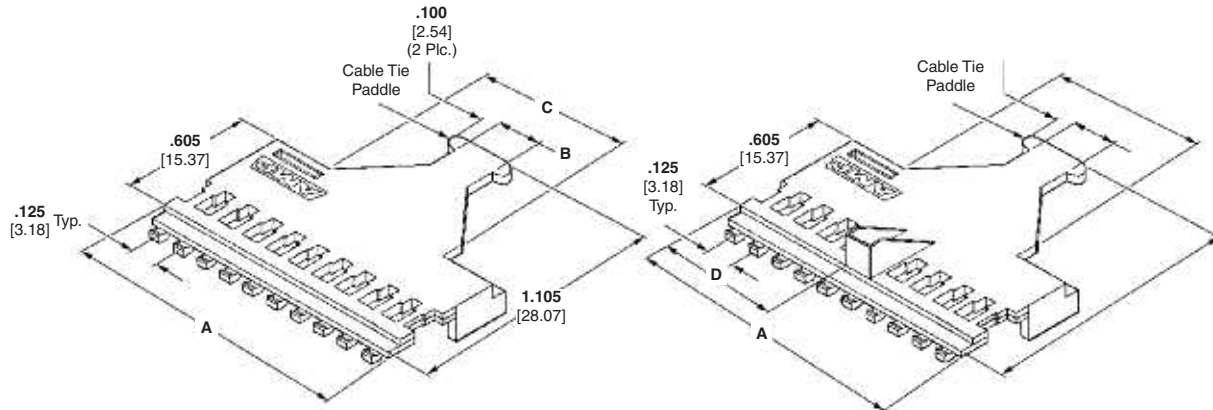

**Cover 103349 Series**  
with Wide Cable Tie Paddle

**Cover 103350 Series**  
with Wide Cable Tie Paddle  
and Polarization

No. of Pos. (Housing Size)	Dimensions					Cover Part Nos.			
	A	B	C	D	E	Without Cable Tie Paddle	With Cable Tie Paddle	With Wide Cable Tie Paddle	With Wide Cable Tie Paddle and Polarization
8	.491 [12.47]	.150 [3.81]	.285 [7.24]	.166 [4.22]	.125 [3.18]	—	—	103349-4	103350-4
10	.616 [15.65]	—	—	—	.125 [3.18]	—	103058-3	—	—
12	.741 [18.82]	—	—	—	.200 [5.08]	—	103058-4	—	—
16	.991 [25.17]	.300 [7.62]	.592 [15.04]	.416 [10.57]	—	—	—	103349-1	103350-1
20	1.241 [31.52]	.300 [7.62]	.592 [15.04]	.541 [13.74]	—	—	—	103349-5	103350-5
24	1.491 [37.87]	—	—	—	.400 [10.16]	1-103056-0	1-103058-0	—	—
32	1.991 [50.57]	.600 [15.24]	1.312 [33.32]	.916 [23.27]	—	—	—	103349-2	103350-2
40	2.491 [63.27]	.750 [19.05]	1.820 [46.23]	1.166 [29.61]	—	—	—	103349-3	103350-3
64	See page 282 for Double Cable Tie Paddle versions.								

- Notes:** 1. Two hermaphroditic covers of any style can be installed on a double-row connector housing.  
2. Other sizes can be made available upon request.

**Note:** All part numbers are RoHS compliant.

**Hermaphroditic Covers for Level V IDC Receptacle Assemblies,  
Double-Row, .125 x .125 [3.18 x 3.18] Centerline** (Continued)

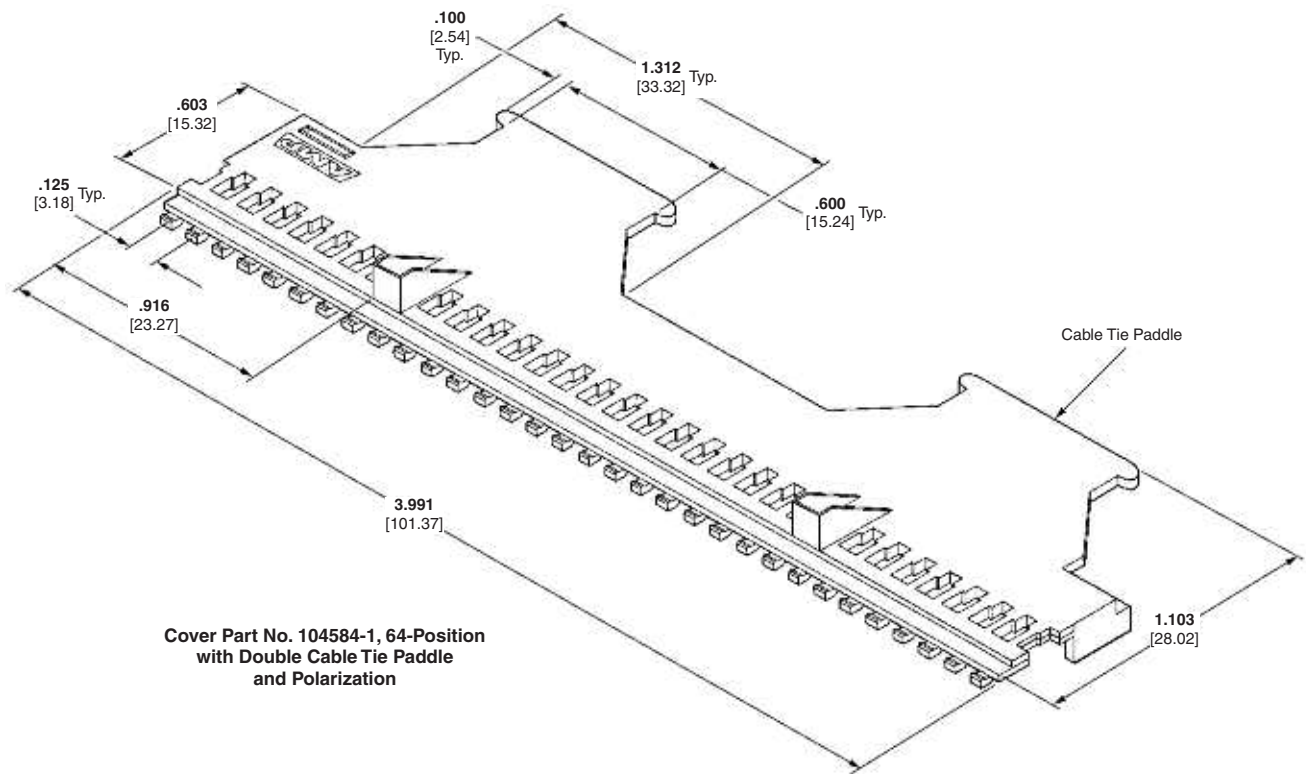
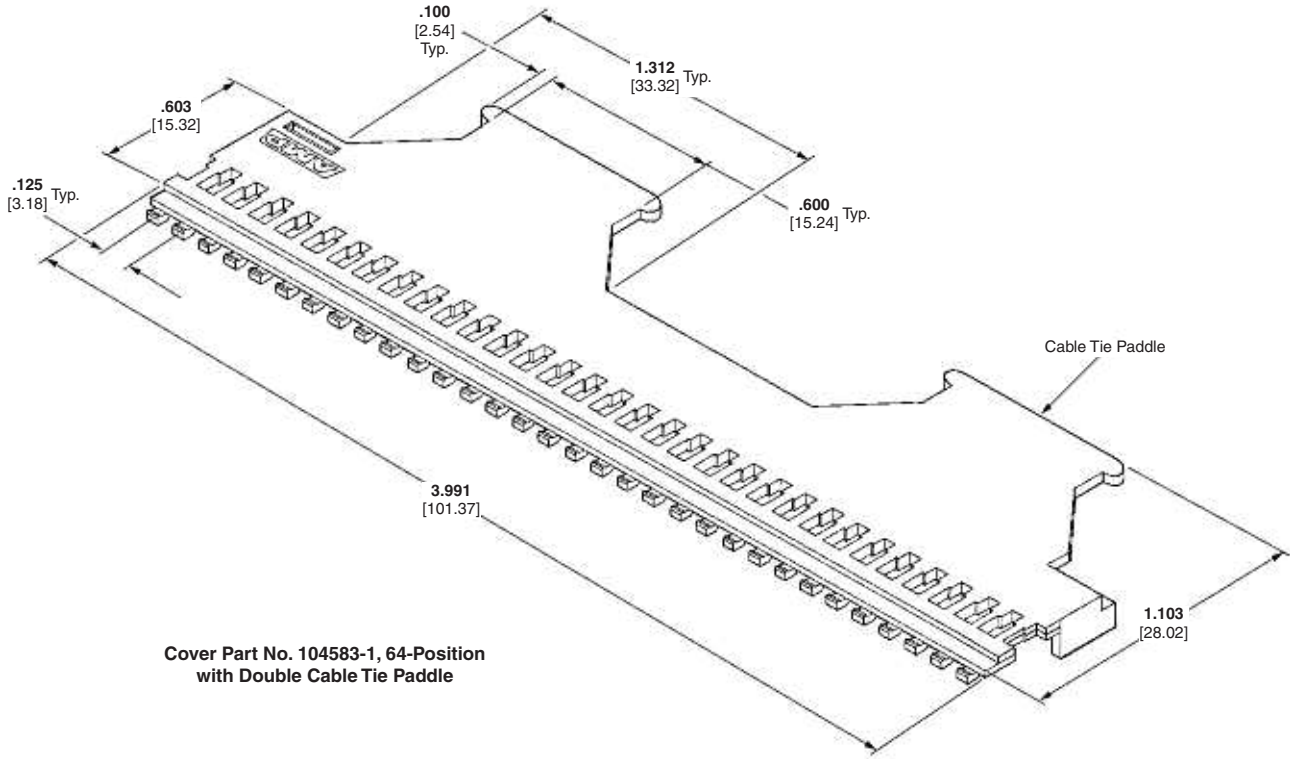

**Note:** All part numbers are RoHS compliant.

.125 [3.18] x .125 [3.18] Centerline  
**6**

## AMPMODU .031 x .062 [0.79 x 1.57] Interconnection System

### Product Facts

- Rugged connector system featuring .031 x .062 [0.79 x 1.57] posts with mating receptacles
- Current rating 5 amps max per contact. Varies due to ambient temperature, wire size and duty cycles.
- Available for board-to-board and wire-to-board applications
- Posts available on strip for machine application directly to pc board or in housings for board mounting
- Receptacles available for board mounting or wire crimping
- Contacts available in both tin and gold plating
- Flame retardant thermoplastic housings 94V-0 rated
- Locking Clip contacts available to mate with .031 x .062 [0.79 x 1.57] posts
- Recognized under the Component Program of Underwriters Laboratories Inc.,  File No. E28476
- Certified by Canadian Standards Association,  File No. LR 16455



The .031 x .062 [0.79 x 1.57] interconnection system has served as an industry standard for modular packaging for over three decades. It is a rugged, large scale system designed for board-to-board and board-to-wire or cable applications that has offered millions of reliable interconnections and countless mating cycles. This versatile interconnection system successfully meets the requirements for most modular power supply packaging.

Board mounted receptacles and receptacle assemblies are available in various geometries, offering packaging interconnections that include perpendicular, parallel and stacking

capabilities. Machine applied terminations, through matched application equipment, are geared to virtually any production requirement, assuring the lowest possible applied cost.

Crimp snap-in receptacles for 26-18 AWG [0.12 – 0.9mm<sup>2</sup>] wire provide excellent discrete wire terminations. Housings for these contacts provide for ease of handling terminations in high density applications.

AMPMODU mating posts are supplied typically as header assemblies. They are available in various sizes to meet the interconnection and packaging requirements of your system. However, in instances where packaging

configurations do not lend themselves to the economies of assemblies, TE can provide for the discrete location of individual posts and receptacles.

If your interconnections require Top Entry, Bottom Entry and/or Side Entry for perpendicular, parallel and stacked configurations, the .031 x .062 [0.79 x 1.57] interconnection system can fulfill your needs with the lowest applied cost through efficient interconnections and supporting application equipment.

**AMPMODU .031 x .062 [0.79 x 1.57] Interconnection System (Continued)**

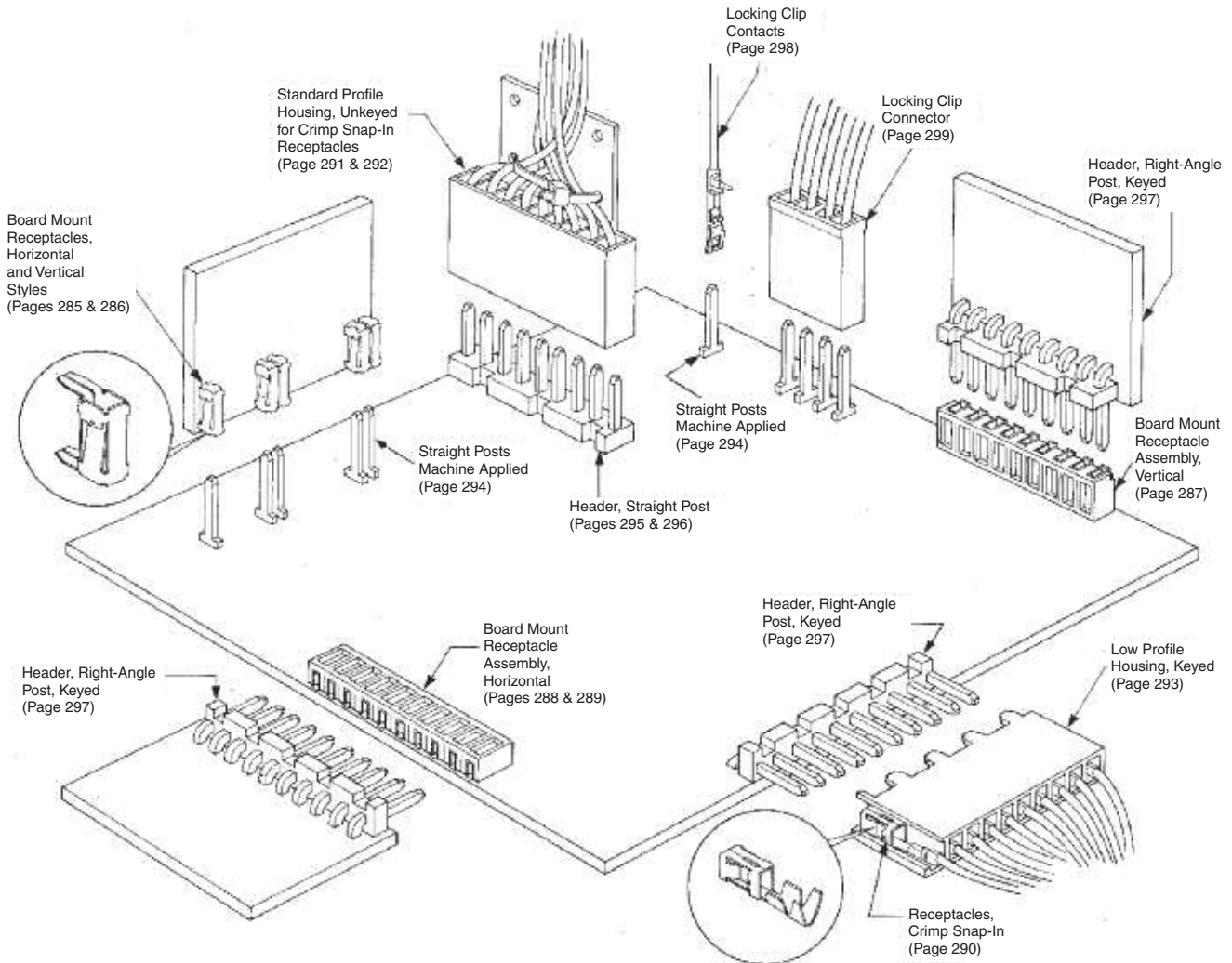

Rugged-self supporting, one-piece contact body

Wide entry for post to receptacle misalignment

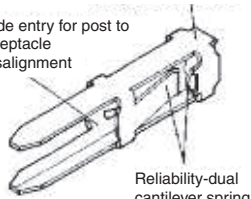

Reliability-dual cantilever spring contact design and built-in anti-overstress

Offers high or low contact forces

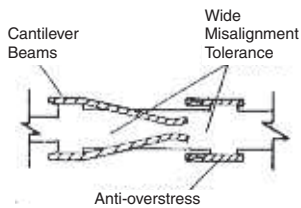

The AMPMODU receptacle cross-section is primarily rectangular, with rounded corners. Two integral cantilever beams contact the mating square or rectangular posts. Deflection of these spring members is limited by anti-overstress and excessive permanent deformation is prevented. This feature allows a wide range of tolerances for misalignment of mating contacts. The configuration of the receptacle completely encloses the spring members preventing damage during handling and assembly and makes the system compatible with automatic application techniques.

This design also permits the use of the receptacles without housings or encapsulation.

**Note:** Application of a contact lubricant is part of the manufacturing process of all AMPMODU tin-plated crimp products. However, it is not part of the manufacturing process of products that customers will solder, then clean. For these products, TE recommends that customers purchase a contact lubricant. (See application specification 114-25004 for further information.)

Insulation Support Barrel

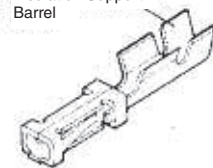

**Wire Crimp Receptacle**

## Mod I Receptacles, Board Mount, .031 x .062 [0.79 x 1.57] Centerline

### Vertical and Horizontal Board Mount

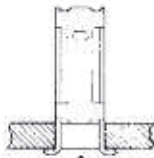

Bottom Post Entry Type A

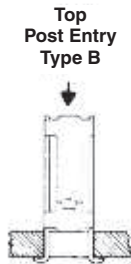

Top Post Entry Type B

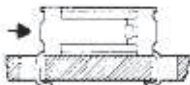

Horizontal Post Entry Type C

### Receptacle Styles

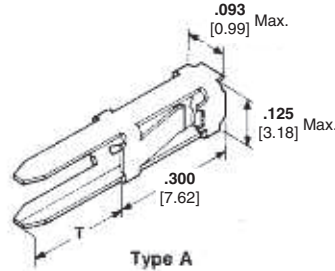

Type A

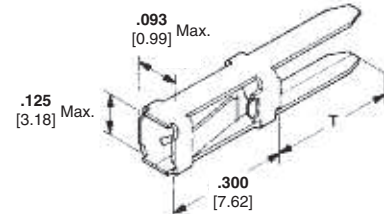

Type B

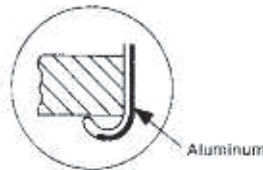

Typical Solder Resist Tab (Type A or B)

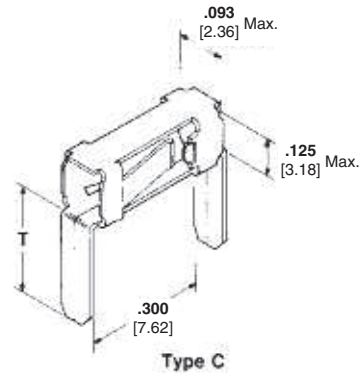

Type C

### Related Product Data Recommended Board Layout for Type C — page 288

- Mates with —
- Machine Applied Posts — page 294
- Headers — pages 295-297
- Application Tooling — pages 300-304
- Performance Specifications — page 305
- Technical Documents — page 305

### Recommended Board Layout for Receptacle Assemblies and Individual Receptacles (Type A and B)

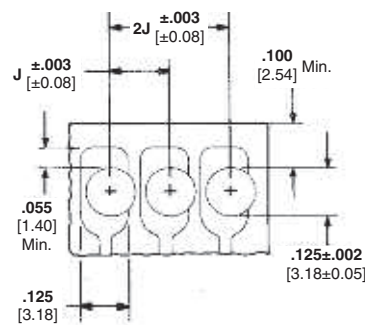

Round Hole (Post Entry Type A or B)

### Keying Plug



Part No. 86181-2  
Use in Board Mount Receptacles

J-Receptacle centers may vary depending on requirements. For individual receptacles, minimum nominal centerline spacing between adjacent receptacles is .150 [3.81]; for receptacle assemblies, centerline spacing between adjacent receptacles is .156 [3.96]. The .003 [0.08] tolerances are not to accumulate over length of board. For solder mask, see TE Instruction Sheet 408-7411.

**Note:** Drawings depict normal use of the contact in a one or two-sided circuit board. When using plated thru-holes, refer to TE Engineering Report ER-001 and TE Instruction Sheet 408-7411. For solder mask, see TE Instruction Sheet 408-7411.

**Note:** All part numbers are RoHS compliant.

**Mod I Receptacles, Board Mount, .031 x .062 [0.79 x 1.57] Centerline** (Continued)

**Material and Finish**

Copper alloy, plated as follows:

**Plating A** — Selectively plated .000030 [0.00076] gold on contact area, with gold flash over .000050 [0.00127] nickel on entire contact

**Plating B** — .000079 [0.00201] min. tin on entire contact

**Plating C** — (Solder Resist) — .000030 [0.00076] gold over .000050 [0.00127] nickel on contact area, .000500 [0.01270] aluminum on inside area of solder tines; remainder of contact unfinished

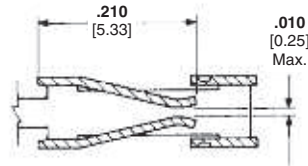

**Standard Pressure Receptacle**

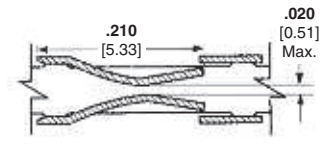

**High Pressure Receptacle**

Type	Board Thickness Range	Dimension T (Ref. Pg. 285)	Finish	Standard Pressure Part Nos.		High Pressure Part Nos.		Insertion Applicator No. for "U" Frame Machine
				Strip Form	Loose Piece	Strip Form	Loose Piece	
A	.070-.055 [1.78-1.40]	.112 [2.84]	Plating A	86477-2	86480-2	—	—	466376-1
			Plating B	86477-3	—	87316-3	—	466376-1
			Plating C (Solder Resist)	87772-2	—	—	—	466376-1
B	.070-.055 [1.78-1.40]	.112 [2.84]	Plating A	87003-1	87105-1	—	—	466376-1
			Plating B	87003-2	—	—	—	466376-1
			Plating C (Solder Resist)	87774-2	—	—	—	466376-1
C	.103-.055 [2.62-1.40]	.145 [3.68]	Plating A	85487-4	85493-4	86432-8	86434-6	565967-3
			Plating B	85487-3	—	86432-1	86434-1	

**Notes:** 1. All strip form parts in packaged quantities of 5,000 each.  
2. All loose piece parts in packaged quantities of 500 each.

**Note:** All part numbers are RoHS compliant.

## Mod I Receptacle Assemblies, Vertical Board Mount, .031 x .062 [0.79 x 1.57] Centerline

### Single Row .156 [3.96] Centerline

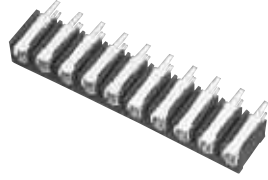

The letter A stamped on contact indicates mating end of receptacle.

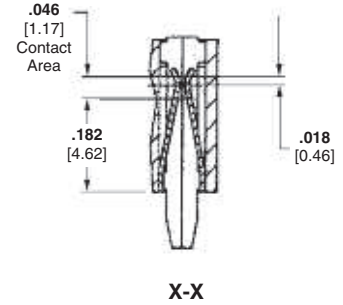
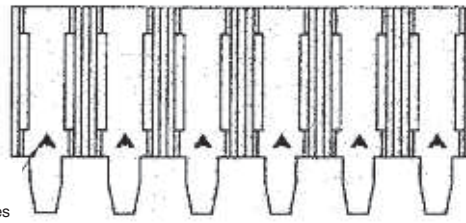

### Material and Finish

**Housing** — Black thermoplastic, 94V-0 rated

**Contacts** — Copper alloy, plated as follows:

**Plating A** — Selectively plated .000030 [0.00076] gold on contact area, with gold flash over .000050 [0.00127] nickel on entire contact

**Plating B** — .000079 [0.00201] min. tin on entire contact

**Plating C** — (Solder Resist) — .000030 [0.00076] gold over .000050 [0.00127] nickel on contact area, .000500 [0.01270] aluminum on inside area of solder tines; remainder of contact unfinished

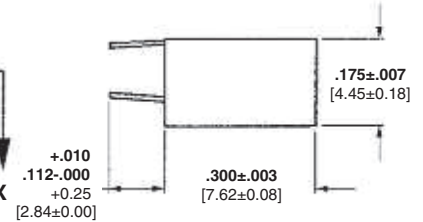
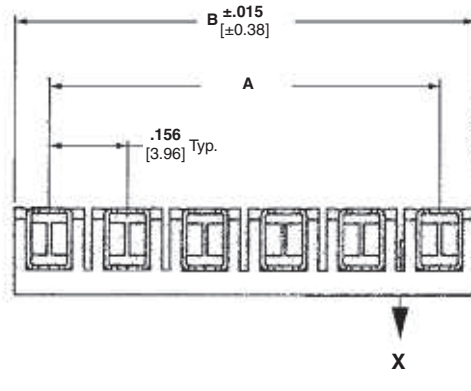

### Related Product Data

**Recommended Board Layout** — page 288

**Mates with** —

**Machine Applied Posts** — page 294

**Headers** — pages 295-297

**Performance Specifications** — page 305

**Technical Documents** — page 305

No. of Pos.	Dimensions		Type A				Type B		
	A	B	Standard Pressure		High Pressure	Standard Pressure			
			Plating A	Plating B	Plating C	Plating B	Plating A	Plating B	Plating C
2	.156 [3.96]	.312 [7.92]	87984-2	87983-2	87989-2	87993-2	87986-2	87985-2	87990-2
3	.312 [7.92]	.468 [11.89]	87984-3	87983-3	87989-3	87993-3	87986-3	87985-3	87990-3
4	.468 [11.89]	.624 [15.85]	87984-4	87983-4	87989-4	87993-4	87986-4	87985-4	87990-4
5	.624 [15.85]	.780 [19.81]	87984-5	87983-5	87989-5	87993-5	87986-5	87985-5	87990-5
6	.780 [19.81]	.936 [23.77]	87984-6	87983-6	87989-6	87993-6	87986-6	87985-6	87990-6
7	.936 [23.77]	1.092 [27.74]	87984-7	87983-7	87989-7	87993-7	87986-7	87985-7	87990-7
8	1.092 [27.74]	1.248 [31.70]	87984-8	87983-8	87989-8	87993-8	87986-8	87985-8	87990-8
9	1.248 [31.70]	1.404 [35.66]	87984-9	87983-9	87989-9	87993-9	87986-9	87985-9	87990-9
10	1.404 [35.66]	1.560 [39.62]	1-87984-0	1-87983-0	1-87989-0	1-87993-0	1-87986-0	1-87985-0	1-87990-0
11	1.560 [39.62]	1.716 [43.59]	1-87984-1	1-87983-1	1-87989-1	1-87993-1	1-87986-1	1-87985-1	1-87990-1
12	1.716 [43.59]	1.872 [47.55]	1-87984-2	1-87983-2	1-87989-2	1-87993-2	1-87986-2	1-87985-2	1-87990-2
13	1.872 [47.55]	2.028 [51.51]	1-87984-3	1-87983-3	1-87989-3	1-87993-3	1-87986-3	1-87985-3	1-87990-3
14	2.028 [51.51]	2.184 [55.47]	1-87984-4	1-87983-4	1-87989-4	1-87993-4	1-87986-4	1-87985-4	1-87990-4
15	2.184 [55.47]	2.340 [59.44]	1-87984-5	1-87983-5	1-87989-5	1-87993-5	1-87986-5	1-87985-5	1-87990-5
16	2.340 [59.44]	2.496 [63.40]	1-87984-6	1-87983-6	1-87989-6	1-87993-6	1-87986-6	1-87985-6	1-87990-6
17	2.496 [63.40]	2.652 [67.36]	1-87984-7	1-87983-7	1-87989-7	1-87993-7	1-87986-7	1-87985-7	1-87990-7
18	2.652 [67.36]	2.808 [71.32]	1-87984-8	1-87983-8	1-87989-8	1-87993-8	1-87986-8	1-87985-8	1-87990-8
19	2.808 [71.32]	2.964 [75.29]	1-87984-9	1-87983-9	1-87989-9	1-87993-9	1-87986-9	1-87985-9	1-87990-9
20	2.964 [75.29]	3.120 [79.25]	2-87984-0	2-87983-0	2-87989-0	2-87993-0	2-87986-0	2-87985-0	2-87990-0

### Keying Plug



Part No. 86181-2  
(Use in Board Mount Receptacles)

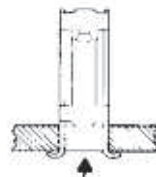

Post Entry Type A



Post Entry Type B

**Note:** All part numbers are RoHS compliant.

## Mod I Receptacle Assemblies, Horizontal Board Mount, .031 x .062 [0.79 x 1.57] Centerline

### Single Row .156 [3.96] Centers

#### Material and Finish

**Housing** — Black thermoplastic, 94V-0 rated

**Contacts** — Copper alloy, plated as follows:

**Plating A** — Selectively plated .000030 [0.00076] gold contact area, with gold flash over .000050 [0.00127] nickel on entire contact

**Plating B** — .000079 [0.00201] min. tin on entire contact

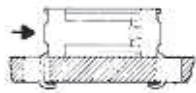

Post Entry Type C

#### Related Product Data

**Mates with** —

**Machine Applied Posts** — page 294

**Headers** — pages 295-297

**Performance Specifications** — page 305

**Technical Documents** — page 305

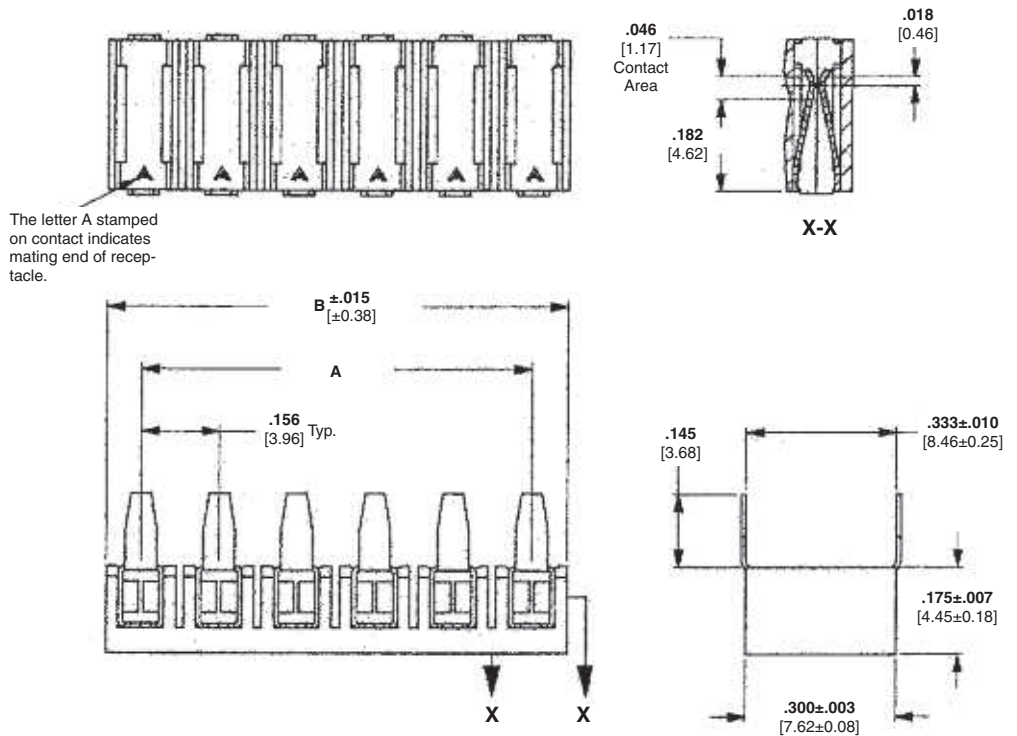

### Recommended Board Layouts for Receptacle Assemblies and Individual Receptacles (Type C)

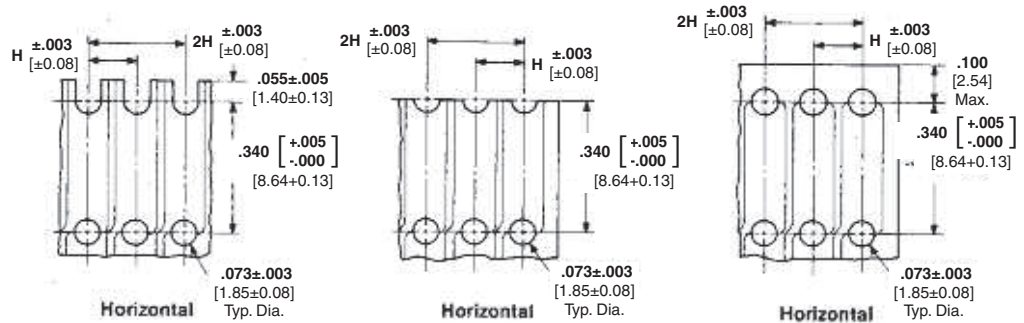

This configuration recommended for use with machine applied posts or headers with a .405 [10.29] minimum mating end post length.\*

This configuration recommended for use with machine applied posts or headers with a .345 [18.76] minimum mating end post length.\*

This configuration recommended for use with machine applied posts or headers with a .500 [12.70] minimum mating end post length.\*

### Keying Plug



Part No. 86181-2  
(Use in Board Mount Receptacles)

The mating post length is depicted by the A dimension on page 294 (machine applied posts) and the C dimension on pages 295-297 (headers).

H-Receptacle centers may vary depending on requirements. For individual receptacles, minimum nominal centerline spacing between adjacent receptacles is .125 [3.18] for receptacle assemblies, centerline spacing between adjacent receptacles is .156 [3.96]. The .003 [0.08] tolerances are not to accumulate over length of board.

**Note:** All part numbers are RoHS compliant.



**Mod I Receptacle Assemblies, Horizontal Board Mount,  
.031 x .062 [0.79 x 1.57] Centerline** (Continued)

No. of Pos.	Dimensions		Standard Pressure		High Pressure
	A	B	Plating A	Plating B	Plating B
2	.156 [3.96]	.312 [7.92]	87988-2	87987-2	87995-2
3	.312 [7.92]	.468 [11.89]	87988-3	87987-3	87995-3
4	.468 [11.89]	.624 [15.85]	87988-4	87987-4	87995-4
5	.624 [15.85]	.780 [19.81]	87988-5	87987-5	87995-5
6	.780 [19.81]	.936 [23.77]	87988-6	87987-6	87995-6
7	.936 [23.77]	1.092 [27.74]	87988-7	87987-7	87995-7
8	1.092 [27.74]	1.248 [31.70]	87988-8	87987-8	87995-8
9	1.248 [31.70]	1.404 [35.66]	87988-9	87987-9	87995-9
10	1.404 [35.66]	1.560 [39.62]	1-87988-0	1-87987-0	1-87995-0
11	1.560 [39.62]	1.716 [43.59]	1-87988-1	1-87987-1	1-87995-1
12	1.716 [43.59]	1.872 [47.55]	1-87988-2	1-87987-2	1-87995-2
13	1.872 [47.54]	2.028 [51.51]	1-87988-3	1-87987-3	1-87995-3
14	2.028 [51.51]	2.184 [55.47]	1-87988-4	1-87987-4	1-87995-4
15	2.184 [55.47]	2.340 [59.44]	1-87988-5	1-87987-5	1-87995-5
16	2.340 [59.44]	2.496 [63.40]	1-87988-6	1-87987-6	1-87995-6
17	2.496 [63.40]	2.652 [67.36]	1-87988-7	1-87987-7	1-87995-7
18	2.652 [67.36]	2.808 [71.32]	1-87988-8	1-87987-8	1-87995-8
19	2.808 [71.32]	2.964 [75.29]	1-87988-9	1-87987-9	1-87995-9
20	2.964 [75.29]	3.120 [79.25]	2-87988-0	2-87987-0	2-87995-0

**Note:** All part numbers are RoHS compliant.

## Mod I Receptacles, Crimp Snap-In (Wire Applied), .031 x .062 [0.79 x 1.57] Centerline

### Material and Finish

Copper alloy, plated as follows:

**Plating A** — Selectively plated .000030 [0.00076] gold on contact area, with gold flash over .000050 [0.00127] nickel on entire contact

**Plating B** — .000016 [0.00041] min. tin on entire contact

### Related Product Data

**Housings used in** — pages 291-293

**Mate with Machine Applied Posts** — page 294

**Headers** — pages 295-297

**Application Tooling** — page 300-304

**Performance Specification** — page 305

**Technical Documents** — page 305

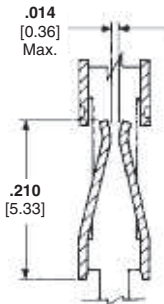
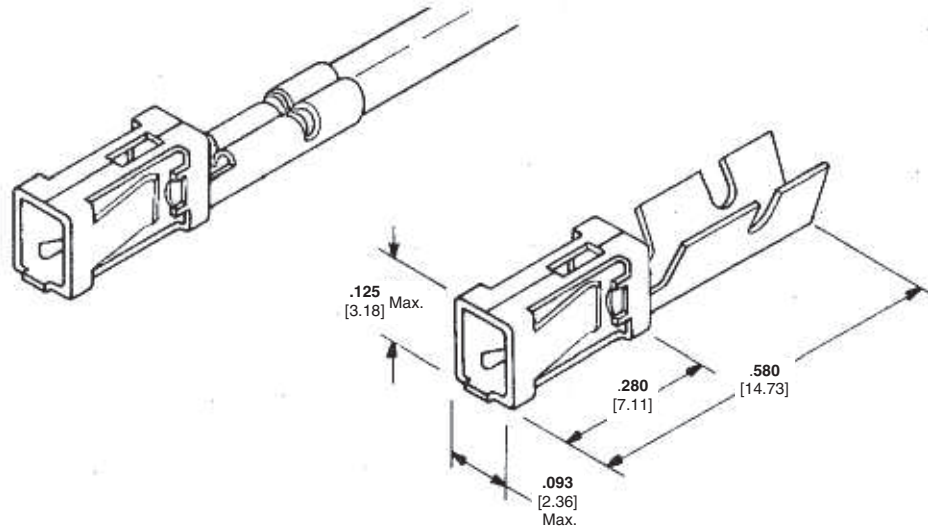

Standard Pressure Receptacle

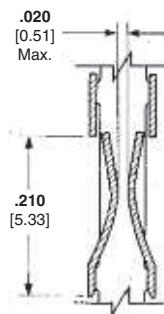

High Pressure Receptacle



Extraction Tool Part No. 843473-1  
Part Instruction Sheet 408-9451

Wire Size Range AWG [mm <sup>2</sup> ]	Ins. Dia. Range	Finish	Standard Pressure			
			Strip Form		Loose Piece	
			Packaged Quantities	Part Nos.	Packaged Quantities	Part Nos.
22-18 [0.3-0.9]	.051-.090 [1.30-2.29]	Plating A	5,000	102099-2	500	102103-2
		Plating B	5,000	102099-5	500	102103-3

Wire Size Range AWG [mm <sup>2</sup> ]	Applicator (Standard Pressure)			Premium CERTI-CRIMP Hand Tool Part Number
	Part Number	Type	Used With Machine	
22-18 [0.3-0.9]	466764-3	HDM	Model "G" (AMP-O-LECTRIC)	90274-2
	466764-2	HDM	Model "K" (AMP-O-LECTRIC)	
	466764-1	HDM	CLS IV+ (AMPOMATOR)	
	466937-1	SCA	Stripper-Crimper (AMP-O-MATIC)	

AMP-O-LECTRIC KII Machine. Applicators also available for AMPOMATOR Lead Making Machines and Stripper/Crimper Machines. Consult TE.

Wire Size Range AWG [mm <sup>2</sup> ]	Ins. Dia. Range	Finish	High Pressure			
			Strip Form		Loose Piece	
			Packaged Quantities	Part Nos.	Packaged Quantities	Part Nos.
22-18 [0.3-0.9]	.051-.090 [1.30-2.29]	Plating A	5,000	102100-2	500	102104-2
		Plating B	5,000	102100-5	500	102104-3
26-22 [0.12-0.4]	0.42-.073 [1.07-1.85]	Plating A	5,000	102102-2	500	102106-2
		Plating B	5,000	102102-5	500	102106-3

Wire Size Range AWG [mm <sup>2</sup> ]	Applicator (High Pressure)			Premium CERTI-CRIMP Hand Tool Part Number
	Part Number	Type	Used With Machine	
22-18 [0.3-0.9]	466764-3	HDM	Model "G" (AMP-O-LECTRIC)	90274-2
	466764-2	HDM	Model "K" (AMP-O-LECTRIC)	
	466764-1	HDM	CLS IV+ (AMPOMATOR)	
	466937-1	SCA	Stripper-Crimper (AMP-O-MATIC)	
26-22 [0.12-0.4]	466763-2	HDM	Model "K" (AMP-O-LECTRIC)	90328-1
	466763-1	HDM	CLS IV+ (AMPOMATOR)	

AMP-O-LECTRIC KII Machine. Applicators also available for AMPOMATOR Lead Making Machines and Stripper/Crimper Machines. Consult TE.

**Note:** All part numbers are RoHS compliant.

## Mod I Receptacle Housings, Standard Profile, Unkeyed, .031 x .062 [0.79 x 1.57] Centerline

Single Row, .156 [3.96] Centers, Without Strain Relief

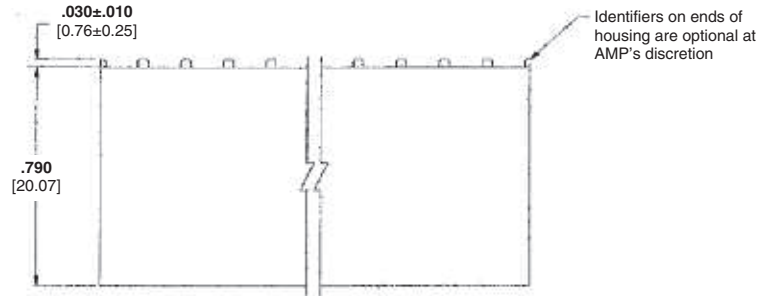
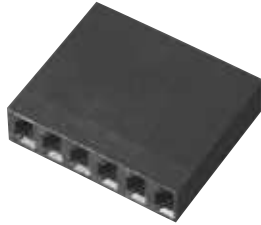

**Material**

Black thermoplastic, flame retardant, 94V-0 rated

**Related Product Data**

- Contacts used with — page 290
- Mate with —
- Machine Applied Posts — page 294
- Headers — pages 295-297
- Performance Specifications — page 305

**Technical Documents** — page 305

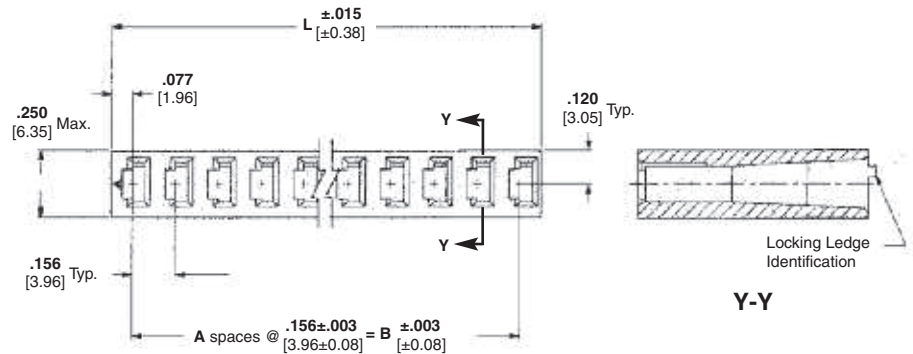

No. of Pos.	Dimensions			Housing Part Nos.	
	A	B	L	Stamped <sup>1</sup>	Unstamped <sup>2</sup>
2	1	.156 [3.96]	.312 [7.92]	—	2-87025-5
3	2	.312 [7.92]	.468 [11.89]	—	2-87025-1
4	3	.468 [11.89]	.624 [15.85]	—	1-87025-3
5	4	.624 [15.85]	.780 [19.81]	—	2-87025-3
6	5	.780 [19.81]	.936 [23.77]	87025-1	87025-2
7	6	.936 [23.77]	1.092 [27.74]	—	3-87025-4
8	7	1.092 [27.74]	1.248 [31.70]	—	1-87025-6
9	8	1.248 [31.70]	1.404 [35.66]	87025-9	1-87025-0
10	9	1.404 [35.66]	1.560 [39.62]	1-87025-7	1-87025-8
11	10	1.560 [39.62]	1.716 [43.59]	—	3-87025-6
12	11	1.716 [43.59]	1.872 [47.55]	1-87025-1	1-87025-2
13	12	1.872 [47.55]	2.028 [51.51]	—	3-87025-0
14	13	2.028 [51.51]	2.184 [55.47]	—	3-87025-8
15	14	2.184 [55.47]	2.340 [59.44]	—	3-87025-2
16	15	2.340 [59.44]	2.496 [63.40]	—	2-87025-0
17	16	2.496 [63.40]	2.652 [67.36]	—	4-87025-0
18	17	2.652 [67.36]	2.808 [71.32]	—	87025-4
19	18	2.808 [71.32]	2.964 [75.29]	—	87025-6
20	19	2.964 [75.29]	3.120 [79.25]	—	87025-8
25	24	3.744 [95.10]	3.900 [99.06]	—	5-87025-0

Notes: <sup>1</sup>Markings on housing.  
<sup>2</sup>No markings on housing.

Note: All part numbers are RoHS compliant.

**Mod I Receptacle Housings, Standard Profile, Unkeyed,  
.031 x .062 [0.79 x 1.57] Centerline** (Continued)

**Single Row, .156 [3.96]  
Centers, With Strain Relief**

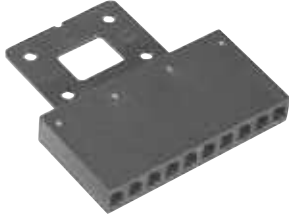

**Material**

Black thermoplastic, flame retardant,  
94V-0 rated

**Related Product Data**

- Contacts used with** — page 290
- Mate with** —
- Machine Applied Posts** — page 294
- Headers** — pages 295-297
- Performance Specifications** —  
page 305

**Technical Documents** —  
page 305

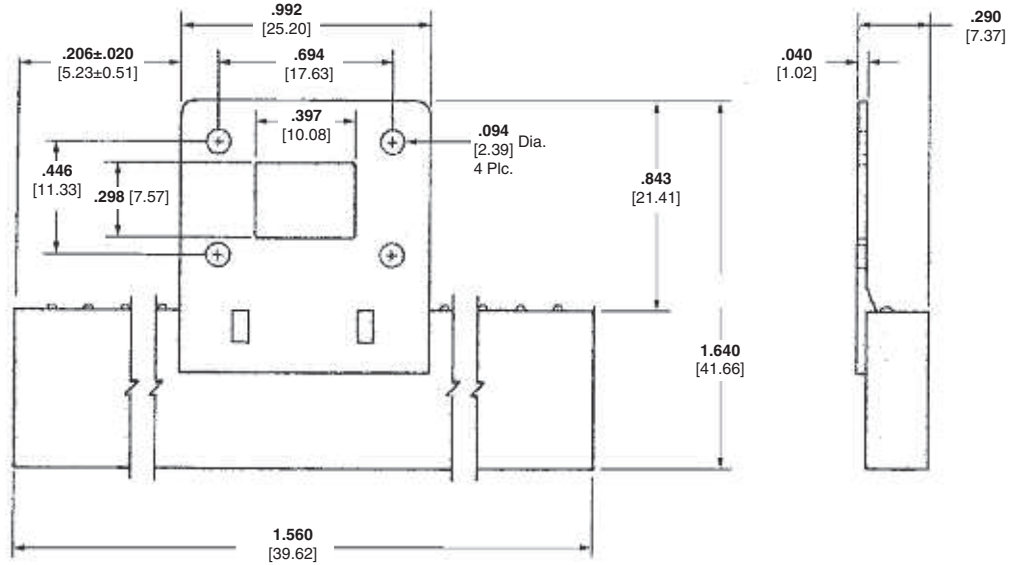

10 Position Receptacle Housing, Part No. 1-102090-0

**Note:** All part numbers are RoHS compliant.

## Mod I Receptacle Housings, Low Profile, Keyed, .031 x .062 [0.79 x 1.57] Centerline

### Single Row, .156 [3.96] Centers

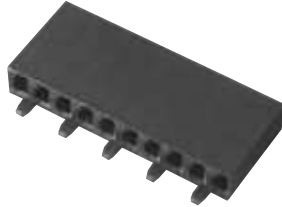

#### Material

Black thermoplastic, flame retardant, 94V-0 rated

#### Related Product Data

Contacts used with — page 290

Mate with —

Headers — pages 295-297

Performance Specifications — page 305

#### Technical Documents —

page 305

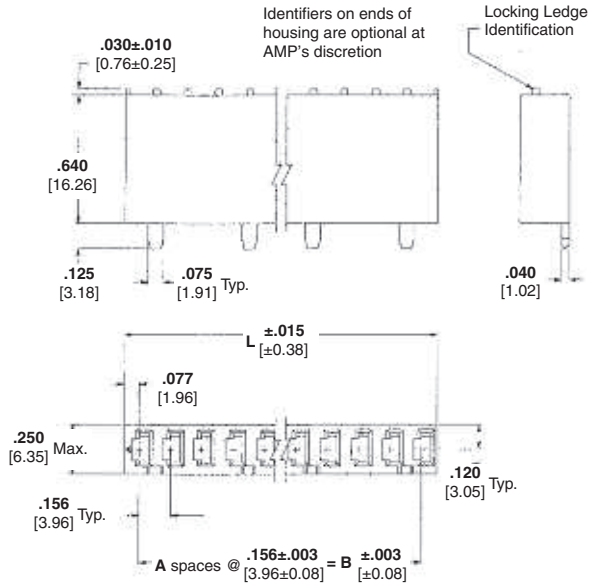

No. of Pos.	Dimensions			No. of Keys	Housing Part Nos. (Unstamped) <sup>1</sup>	Key Locations
	A	B	L			
2	1	.156 [3.96]	.312 [7.92]	1	87159-3	A
3	2	.312 [7.92]	.468 [11.89]	1	87159-4	A
4	3	.468 [11.89]	.624 [15.85]	2	87159-5	A,C
5	4	.624 [15.85]	.780 [19.81]	2	87159-1	A,D
6	5	.780 [19.81]	.936 [23.77]	3	87159-6	A,C,E
7	6	.936 [23.77]	1.092 [27.74]	3	87159-7	A,C,E
8	7	1.092 [27.74]	1.248 [31.70]	4	87159-8	A,C,E,G
9	8	1.248 [31.70]	1.404 [35.66]	3	87159-9	A,D,G
10	9	1.404 [35.66]	1.560 [39.62]	5	1-87159-0	A,C,E,G,J
11	10	1.560 [39.62]	1.716 [43.59]	4	1-87159-1	A,D,G,K
12	11	1.716 [43.59]	1.872 [47.55]	6	1-87159-2	A,C,E,G,J,L
13	12	1.872 [47.55]	2.028 [51.51]	4	87159-2	A,D,J,M
14	13	2.028 [51.51]	2.184 [55.47]	7	1-87159-3	A,C,E,G,J,L,N
15	14	2.184 [55.47]	2.340 [59.44]	5	1-87159-4	A,D,G,K,N
16	15	2.340 [59.44]	2.496 [63.40]	8	1-87159-5	A,C,E,G,J,L,N,Q
17	16	2.496 [63.40]	2.652 [67.36]	6	1-87159-6	A,D,G,K,N,R
18	17	2.652 [67.36]	2.808 [71.32]	6	1-87159-7	A,D,F,J,P,S
19	18	2.808 [71.32]	2.964 [75.29]	8	1-87159-8	B,D,F,J,L,N,Q,S
20	19	2.964 [75.29]	3.120 [79.25]	10	1-87159-9	A,C,E,G,J,L,N,Q,S,U
25	24	3.744 [95.10]	3.900 [99.06]	11	2-87159-4	A,C,E,H,K,M,Q,S,U,W,Y

<sup>1</sup>No marking on housing.

### Keying Plug

Material — Natural Color Nylon

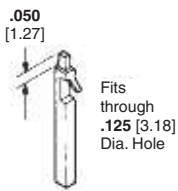

Part No. 87116-2

### Keying Plug References

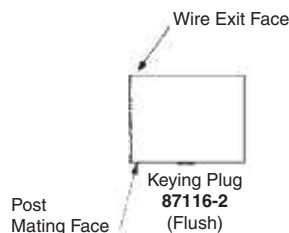

For Standard Housings

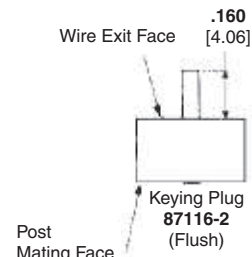

For Low Profile Housings

Note: All part numbers are RoHS compliant.

**Mod I Posts, Machine Applied, .031 x .062 [0.79 x 1.57] Centerline**

**Straight Posts**

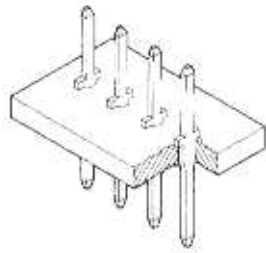

Typical Assembly

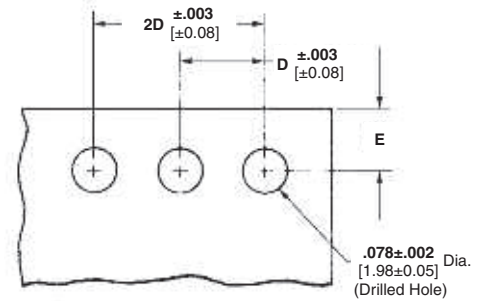
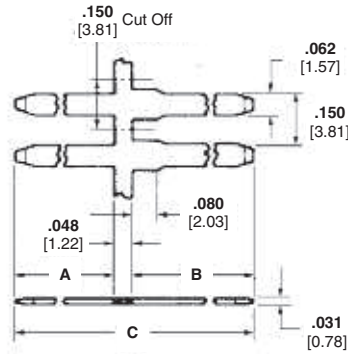

Recommended Mounting Holes

**Material and Finish**

Brass, plated .000030 [0.00076] gold over .000050 [0.00127] nickel on entire post

**Related Product Data**

Mate with —

**Board Mount Receptacles** — pages 285, 286

**Board Mount Receptacle Assemblies** — pages 287-289

**Crimp Snap-In Receptacles and Housings** — pages 290-292

**Locking Clip Contacts & Housings** — pages 298, 299 (see page 298 for recommended post length).

**Application Tooling** — pages 300-304

**Performance Specifications** — page 305

**Technical Documents** — page 305

D—Post centers may vary depending on requirements. Minimum nominal centerline spacing between adjacent contacts is .125 [3.18]; .003 [0.08] tolerances not to accumulate over length of board.  
E—Post center location from edge of board may vary to satisfy application.

A	Dimensions			Finish	Part Nos.	
	B	C	Strip Form <sup>1</sup>		Loose Piece <sup>2</sup>	
.360 [9.14]	.187 [4.75]	.595 [15.11]	Plating A	86147-7	86182-7	
			Plating B	5086147-2	5086182-2	
.380 [9.65]	.320 [8.13]	.748 [19.00]	Plating A	1-86147-5	1-86182-5	
			Plating B	5086147-9	5086182-9	
.400 [10.16]	.125 [3.18]	.573 [14.55]	Plating A	4-86147-2	2-86182-9	
			Plating B	3-5086147-7	2-5086182-5	
.480 [12.19]	.187 [4.75]	.715 [18.16]	Plating A	1-86147-8	1-86182-8	
			Plating B	2-5086147-2	2-5086182-2	
.565 [14.35]	.187 [4.75]	.800 [20.32]	Plating A	86147-8	86182-8	
			Plating B	5086147-1	5086182-1	
.800 [20.32]	.150 [3.81]	.998 [25.35]	Plating A	1-86147-2	1-86182-2	
			Plating B	1-5086147-0	1-5086182-0	

<sup>1</sup> Packaging quantity of 20,000 per reel.

<sup>2</sup> Packaging quantity of 1,000 per bag.

**Note:** Strip form posts applied with Insertion Machine No. 3-457382-1, includes power unit and applicator.

**Note:** All part numbers are RoHS compliant.

**Mod I Headers, Straight Post, Keyed, .031 x .062 [0.79 x 1.57] Centerline**

**Single Row, .156 [3.96] Centers**

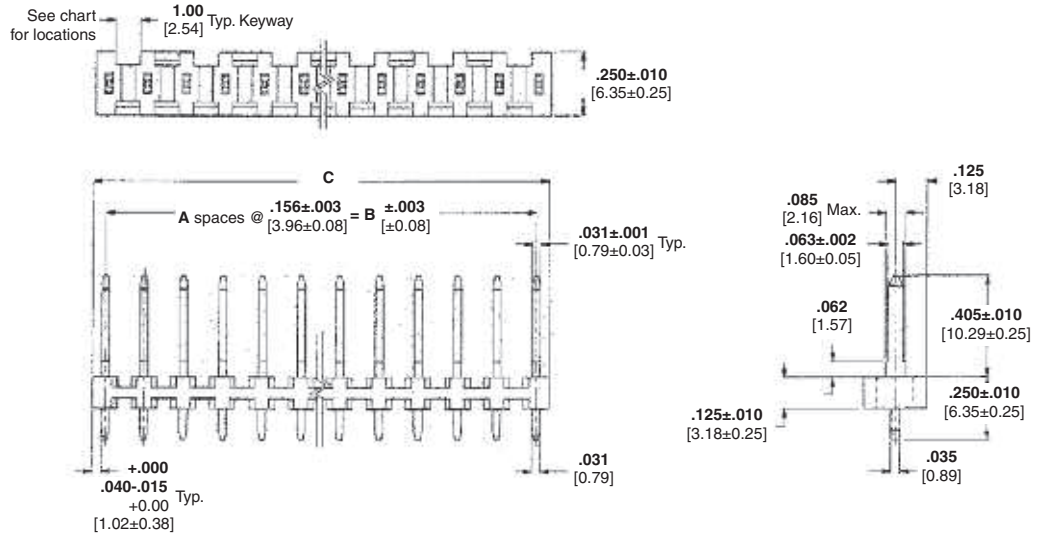
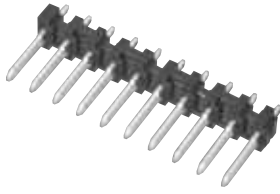

**Material and Finish**

**Housing** — Black thermoplastic, 94V-0 rated

**Posts** — Brass, plated as follows:

**Plating A** — Selectively plated .000030 [0.00076] gold on contact area, with gold flash over .000050 [0.00127] min. nickel on entire post

**Plating B** — .000100-.000200 [0.00254-0.00508] tin over .000030 [0.00762] nickel on entire post

**Related Product Data**

**Mate with — Board Mount Receptacles** — pages 285, 286

**Board Mount Receptacle Assemblies** — pages 287-289

**Crimp Snap-In Receptacles and Housings** — pages 290-292

**Locking Clip Contacts & Housings** — pages 298 & 299 (see page 298 for recommended post length).

**Performance Specifications** — page 305

**Technical Documents** — page 305

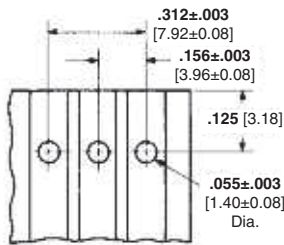

**Recommended Board Layout**

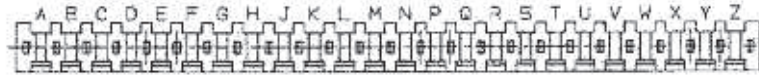

**Keyway Locations (Ref only)**

No. of Pos.	A	Dimensions		C	No. of Keying Slots	Post Height D=.405 [10.29]		Post Height D=.587 [14.91]		Keyway Locations
		B				Plating A	Plating B	Plating A	Plating B	
2	1	.156 [3.96]		.267 [6.78]	1	85829-2	5-87160-4	87247-2	5-87262-2	A
3	2	.312 [7.92]		.423 [10.74]	1	85829-3	5-87160-5	87247-3	5-87262-3	A
4	3	.468 [11.89]		.579 [14.71]	2	85829-4	5-87160-6	87247-4	5-87262-4	A,C
5	4	.624 [15.85]		.735 [18.67]	2	85829-5	5-87160-1	87247-5	5-87262-5	A,D
6	5	.780 [19.81]		.891 [22.63]	3	85829-6	5-87160-7	87247-6	5-87262-6	A,C,E
7	6	.936 [23.77]		1.047 [26.59]	3	85829-7	5-87160-8	87247-7	5-87262-7	A,C,E
8	7	1.092 [27.74]		1.203 [30.56]	4	85829-8	5-87160-9	87247-8	5-87262-8	A,C,E,G
9	8	1.248 [31.70]		1.359 [34.52]	3	85829-9	6-87160-0	87247-9	5-87262-9	A,D,G
10	9	1.404 [35.66]		1.515 [38.48]	5	1-85829-0	6-87160-1	1-87247-0	6-87262-0	A,C,E,G,J
11	10	1.560 [39.62]		1.671 [42.44]	4	1-85829-1	6-87160-2	1-87247-1	6-87262-1	A,D,G,K
12	11	1.716 [43.59]		1.827 [46.41]	6	1-85829-2	6-87160-3	1-87247-2	6-87262-2	A,C,E,G,J,L
13	12	1.872 [47.55]		1.983 [50.37]	4	1-85829-3	5-87160-2	1-87247-3	6-87262-3	A,D,J,M
14	13	2.028 [51.51]		2.139 [54.33]	7	1-85829-4	6-87160-4	1-87247-4	6-87262-4	A,C,E,G,J,L,N
15	14	2.184 [55.47]		2.295 [58.29]	5	1-85829-5	6-87160-5	1-87247-5	6-87262-5	A,D,G,K,N
16	15	2.340 [59.44]		2.451 [62.26]	8	1-85829-6	6-87160-6	1-87247-6	6-87262-6	A,C,E,G,J,L,N,Q
17	16	2.496 [63.40]		2.607 [66.22]	6	1-85829-7	6-87160-7	1-87247-7	6-87262-7	A,D,G,K,N,R
18	17	2.652 [67.36]		2.763 [70.18]	7	1-85829-8	6-87160-8	1-87247-8	6-87262-8	A,D,F,J,M,P,S
19	18	2.808 [71.32]		2.919 [74.14]	8	1-85829-9	6-87160-9	1-87247-9	6-87262-9	B,D,F,J,L,N,Q,S
20	19	2.964 [75.29]		3.075 [78.11]	10	2-85829-0	7-87160-0	2-87247-0	7-87262-0	A,C,E,G,J,L,N,Q,S,U
21	20	3.120 [79.25]		3.231 [82.07]	7	2-85829-1	7-87160-1	2-87247-1	7-87262-1	A,D,G,K,N,R,U
22	21	3.276 [83.21]		3.387 [86.03]	11	2-85829-2	7-87160-2	2-87247-2	7-87262-2	A,C,E,G,J,L,N,Q,S,U,W
23	22	3.432 [87.17]		3.543 [89.99]	8	2-85829-3	7-87160-3	2-87247-3	7-87262-3	A,D,G,K,N,R,U,X
24	23	3.588 [91.14]		3.699 [93.95]	12	2-85829-4	7-87160-4	2-87247-4	7-87262-4	A,C,E,G,J,L,N,Q,S,U,W,Y
25	24	3.744 [95.10]		3.855 [97.92]	11	2-85829-5	7-87160-5	2-87247-5	7-87262-5	A,C,E,H,K,M,Q,S,U,W,Y

**Note:** All part numbers are RoHS compliant.

**Mod I Headers, Straight Post, Keyed,  
.031 x .062 [0.79 x 1.57] Centerline** (Continued)

No. of Pos.	Dimensions			No. of Keying Slots	Post Height D=.750 [19.05]		Post Height D=1.187 [30.15]		Post Height D=1.310 [33.27]		Keyway Locations
	A	B	C		Plating A	Plating B	Plating A	Plating B	Plating A	Plating B	
	2	1	.156 [3.96]		.267 [6.78]	1	85923-2	5-85875-7	87283-2	—	
3	2	.312 [7.92]	.423 [10.74]	1	85923-3	5-85875-8	87283-3	5-86207-2	85839-3	5-85840-3	A
4	3	.468 [11.89]	.579 [14.71]	2	85923-4	5-85875-1	87283-4	5-86207-9	85839-4	5-85840-4	A,C
5	4	.624 [15.85]	.735 [18.67]	2	85923-5	5-85875-2	87283-5	5-86207-3	85839-5	5-85840-5	A,D
6	5	.780 [19.81]	.891 [22.63]	3	85923-6	5-85875-9	87283-6	—	85839-6	5-85840-6	A,C,E
7	6	.936 [23.77]	1.047 [26.59]	3	85923-7	6-85875-0	87283-7	—	85839-7	5-85840-7	A,C,E
8	7	1.092 [27.74]	1.203 [30.56]	4	85923-8	6-85875-1	87283-8	—	85839-8	5-85840-8	A,C,E,G
9	8	1.248 [31.70]	1.359 [34.52]	3	85923-9	5-85875-3	87283-9	—	85839-9	5-85840-9	A,D,G
10	9	1.404 [35.66]	1.515 [38.48]	5	1-85923-0	6-85875-2	1-87283-0	—	1-85839-0	6-85840-0	A,C,E,G,J
11	10	1.560 [39.62]	1.671 [42.44]	4	1-85923-1	6-85875-3	1-87283-1	—	1-85839-1	6-85840-1	A,D,G,K
12	11	1.716 [43.59]	1.827 [46.41]	6	1-85923-2	5-85875-4	1-87283-2	—	1-85839-2	6-85840-2	A,C,E,G,J,L
13	12	1.872 [47.55]	1.983 [50.37]	4	1-85923-3	6-85875-4	1-87283-3	—	1-85839-3	6-85840-3	A,D,J,M
14	13	2.028 [51.51]	2.139 [54.33]	7	1-85923-4	6-85875-5	1-87283-4	—	1-85839-4	6-85840-4	A,C,E,G,J,L,N
15	14	2.184 [55.47]	2.295 [58.29]	5	1-85923-5	6-85875-6	1-87283-5	—	1-85839-5	6-85840-5	A,D,G,K,N
16	15	2.340 [59.44]	2.451 [62.26]	8	1-85923-6	6-85875-7	1-87283-6	—	1-85839-6	6-85840-6	A,C,E,G,J,L,N,Q
17	16	2.496 [63.40]	2.607 [66.22]	6	1-85923-7	6-85875-8	1-87283-7	—	1-85839-7	6-85840-7	A,D,G,K,N,R
18	17	2.652 [67.36]	2.763 [70.18]	7	1-85923-8	6-85875-9	1-87283-8	—	1-85839-8	6-85840-8	A,D,F,J,M,P,S
19	18	2.808 [71.32]	2.919 [74.14]	8	1-85923-9	7-85875-0	1-87283-9	—	1-85839-9	6-85840-9	B,D,F,J,L,N,Q,S
20	19	2.964 [75.29]	3.075 [78.11]	10	2-85923-0	7-85875-1	2-87283-0	—	2-85839-0	7-85840-0	A,C,E,G,J,L,N,Q,S,U
21	20	3.120 [79.25]	3.231 [82.07]	7	2-85923-1	7-85875-2	2-87283-1	—	2-85839-1	7-85840-1	A,D,G,K,N,R,U
22	21	3.276 [83.21]	3.387 [86.03]	11	2-85923-2	7-85875-3	2-87283-2	—	2-85839-2	7-85840-2	A,C,E,G,J,L,N,Q,S,U,W
23	22	3.432 [87.17]	3.543 [89.99]	8	2-85923-3	5-85875-5	2-87283-3	—	2-85839-3	7-85840-3	A,D,G,K,N,R,U,X
24	23	3.588 [91.14]	3.699 [93.95]	12	2-85923-4	7-85875-4	2-87283-4	—	2-85839-4	7-85840-4	A,C,E,G,J,L,N,Q,S,U,W,Y
25	24	3.744 [95.10]	3.855 [97.92]	11	2-85923-5	7-85875-5	2-87283-5	—	2-85839-5	7-85840-5	A,C,E,H,K,M,Q,S,U,W,Y

Note: All part numbers are RoHS compliant.



**Mod I Headers, Right-Angle Post, Keyed, .031 x .062 [0.79 x 1.57] Centerline**

**Single Row, .156 [3.96] Centers**

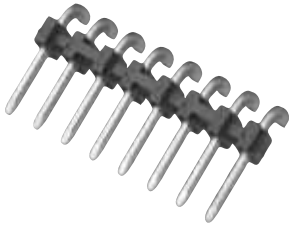

**Material and Finish**

**Housing** — Black thermoplastic, 94V-0 rated

**Posts** — Brass, plated as follows:

**Plating A** — Selectively plated .000030 [0.00076] gold on contact area, with gold flash over .000050 [0.00127] nickel on entire post

**Plating B** — .000015 [0.00038] gold over .000050 [0.00127] nickel on entire post

**Plating C** — .00100-.000200 [0.00254-0.00508] tin over .000050 [0.00127] nickel on entire post

**Related Product Data**

**Mate with** —  
**Board Mount Receptacles** — pages 285, 286

**Board Mount Receptacle Assemblies** — pages 287-289

**Crimp Snap-In Receptacles and Housings** — pages 290-292

**Locking Clip Contacts and Housings** — pages 298 & 299 (see page 298 for recommended post length).

**Performance Specifications** — page 305

**Technical Documents** — page 305

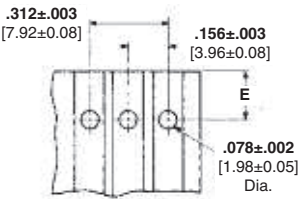

**Recommended Board Layout**

**E Dimension**

**.345 [8.76] Post Height** — .250 [6.35] for mounting header flush with board edge; .595 [15.11] for supporting mating connector on board.

**.500 [12.70] Post Height** — .250 [6.35] for mounting header flush with board edge; .750 [19.05] for supporting mating connector on board.

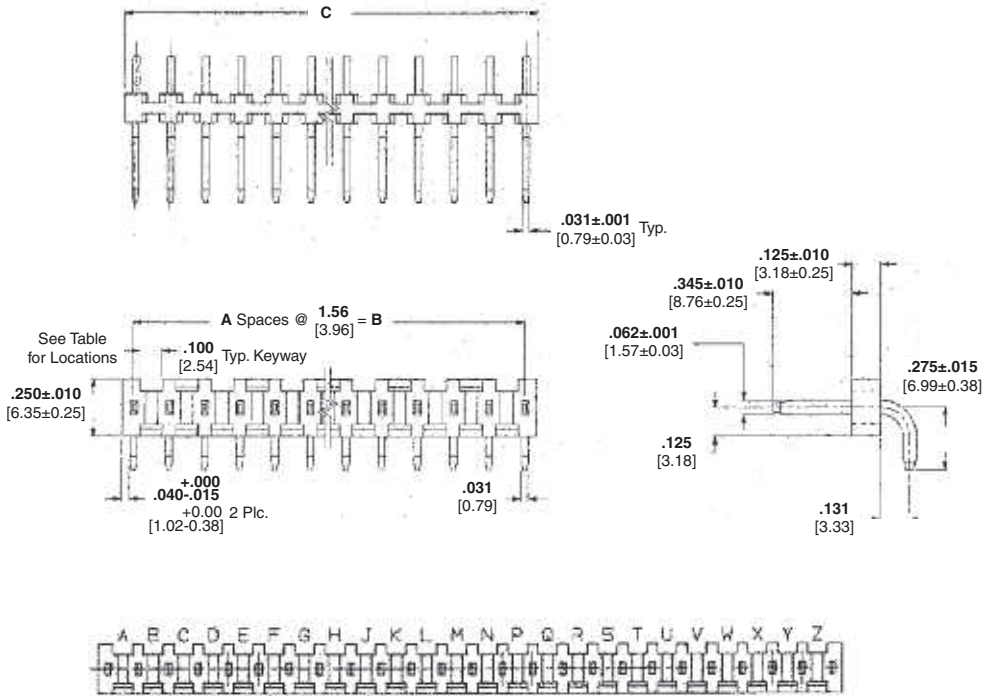

**Keyway Locations (Ref Only)**

No. of Pos.		Dimensions			No. of Keying Slots	Post Height D=.345 [8.76]		Post Height D=.500 [12.70]		Keyway Locations
		A	B	C		Plating A	Plating C	Plating B	Plating C	
2	1	.156 [3.96]	.267 [6.78]	1	87654-2	5-87655-2	87258-2	5-87194-1	A	
3	2	.312 [7.92]	.423 [10.74]	1	87654-3	5-87655-3	87258-3	5-87194-2	A	
4	3	.468 [11.89]	.579 [14.71]	2	87654-4	5-87655-4	87258-4	5-87194-3	A,C	
5	4	.624 [15.85]	.735 [18.67]	2	87654-5	5-87655-5	87258-5	5-87194-4	A,D	
6	5	.780 [19.81]	.891 [22.63]	3	87654-6	5-87655-6	87258-6	5-87194-5	A,C,E	
7	6	.936 [23.77]	1.047 [26.59]	3	87654-7	5-87655-7	87258-7	5-87194-6	A,C,E	
8	7	1.092 [27.74]	1.203 [30.56]	4	87654-8	5-87655-8	87258-8	5-87194-7	A,C,E,G	
9	8	1.248 [31.70]	1.359 [34.52]	3	87654-9	5-87655-9	87258-9	5-87194-8	A,D,G	
10	9	1.404 [35.66]	1.515 [38.48]	5	1-87654-0	6-87655-0	1-87258-0	5-87194-9	A,C,E,G,J	
11	10	1.560 [39.62]	1.671 [42.44]	4	1-87654-1	6-87655-1	1-87258-1	6-87194-0	A,D,G,K	
12	11	1.716 [43.59]	1.827 [46.41]	6	1-87654-2	6-87655-2	1-87258-2	6-87194-1	A,C,E,G,J,L	
13	12	1.872 [47.55]	1.983 [50.37]	4	1-87654-3	6-87655-3	1-87258-3	6-87194-2	A,D,J,M	
14	13	2.028 [51.51]	2.139 [54.33]	7	1-87654-4	6-87655-4	1-87258-4	6-87194-3	A,C,E,G,J,L,N	
15	14	2.184 [55.47]	2.295 [58.29]	5	1-87654-5	6-87655-5	1-87258-5	6-87194-4	A,D,G,K,N	
16	15	2.340 [59.44]	2.451 [62.26]	8	1-87654-6	6-87655-6	1-87258-6	6-87194-5	A,C,E,G,J,L,N,Q	
17	16	2.496 [63.40]	2.607 [66.22]	6	1-87654-7	6-87655-7	1-87258-7	6-87194-6	A,D,G,K,N,R	
18	17	2.652 [67.36]	2.763 [70.18]	7	1-87654-8	6-87655-8	1-87258-8	6-87194-7	A,D,F,J,M,PS	
19	18	2.808 [71.32]	2.919 [74.14]	8	1-87654-9	6-87655-9	1-87258-9	6-87194-8	B,D,F,J,L,N,Q,S	
20	19	2.964 [75.29]	3.075 [78.11]	10	2-87654-0	7-87655-0	2-87258-0	6-87194-9	A,C,E,G,J,L,N,Q,S,U	
21	20	3.120 [79.25]	3.231 [82.07]	7	2-87654-1	7-87655-1	2-87258-1	7-87194-0	A,D,G,K,N,R,U	
22	21	3.276 [83.21]	3.387 [86.03]	11	2-87654-2	7-87655-2	2-87258-2	7-87194-1	A,C,E,G,J,L,N,Q,S,U,W	
23	22	3.432 [87.17]	3.543 [89.99]	8	2-87654-3	7-87655-3	2-87258-3	7-87194-2	A,D,G,K,N,R,U,X	
24	23	3.588 [91.14]	3.699 [93.95]	12	2-87654-4	7-87655-4	2-87258-4	7-87194-3	A,C,E,G,J,L,N,Q,S,U,W,Y	
25	24	3.744 [95.10]	3.855 [97.92]	11	2-87654-5	7-87655-5	2-87258-5	7-87194-4	A,C,E,H,K,M,Q,S,U,W,Y	

**Note:** All part numbers are RoHS compliant.

## Locking Clip Contacts for .031 x .062 [0.79 x 1.57] Posts, .031 x .062 [0.79 x 1.57] Centerline

### Wire Crimp Contacts with Insulation Support

#### Material and Finish

**Contact Body** — Phosphor bronze, plated as follows:

**Plating A** — Selectively plated .00015 [0.00038] gold on contact area, with gold flash over .000050 [0.00127] nickel on entire post

**Plating B** — .000100 [0.00254] min. tin over .000050 [0.00127] nickel on entire contact

**Contact Spring** — Stainless steel

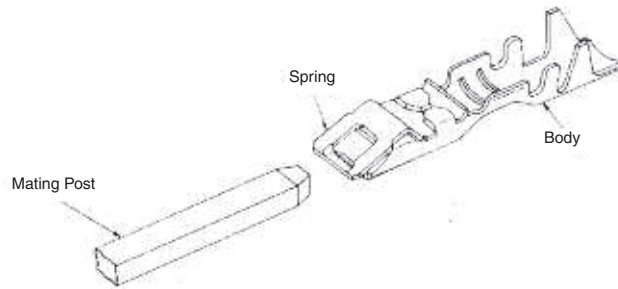

#### Related Product Data

**Mate with** —  
**Machine Applied Posts** — page 294  
**Headers (.500 Post Height Only)** — pages 295-297 (see recommended post length below)\*

**Housings used in** — page 299

**Application Tooling** — pages 300-304

**Performance Specification** — page 305

**Technical Documents** — page 305

Wire Size Range AWG [mm <sup>2</sup> ]	Ins. Dia. Range	Finish	Contact Part Nos.	
			Strip Form	Loose Piece
22-18 [0.3-0.9]	.050-.0100 [1.27-2.54]	Plating A	87269-2	87278-2
		Plating B	5-87269-1	5-87278-1

Wire Size Range AWG [mm <sup>2</sup> ]	Applicator			Premium CERTI-CRIMP Hand Tool Part Number
	Part Number	Type	Used With Machine	
22-18 [0.3-0.9]	466007-2	HDM	Model "K" (AMP-O-LECTRIC) <sup>1</sup>	90308-1
	466950-2	SCA	Stripper/Crimper (AMP-O-MATIC)	

<sup>1</sup>AMP-O-LECTRIC KII Machine. Applicators also available for AMPOMATOR Lead Making Machines. Consult TE. **Note:** These contacts must be crimped in accordance with TE Specification No. 114-25008 in order to function properly in a connector housing. Extraction Tool **Part No. 91104-1** is used for removing individual contacts from connector housings and for detaching contacts from mating posts.



Extraction Tool  
Part No. 91104-1

Instruction Sheet  
408-7678

### Wire Harnessing

If necessary, wires can be grouped with cable ties and secured to a panel with fixed clamps. However, locking clip contacts must be free to float within the connector housings to allow proper extraction. Therefore, harnessing hardware or the use of multiple terminations per contact must not restrict the free-floating action of contacts in the housing. For more information, request Insulating and Bundling Products Catalog 124132.

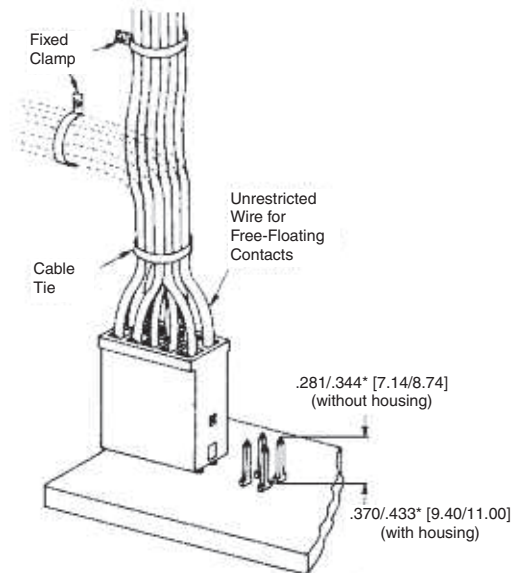

\*Dimension defines .031 x .062 [0.79 x 1.57] portion of post. If post is longer than maximum specified, post tip may butt against wire ends.

**Note:** All part numbers are RoHS compliant.

**Locking Clip Connector Housings, .031 x .062 [0.79 x 1.57] Centerline**

**Single Row, .156 [3.96] Centers**

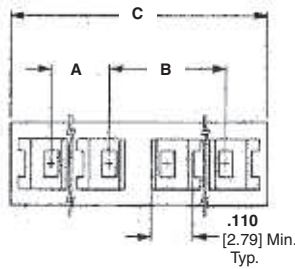

**Material and Finish**

Black thermoplastic, 94V-0 rated

**Related Product Data**

**Contacts used with** — page 298

**Mate with** —

**Machine Applied Posts** — page 294

**Headers** — pages 295-297 (see page 298 for recommended post length)

**Performance Specifications** — page 305

**Technical Documents** — page 305

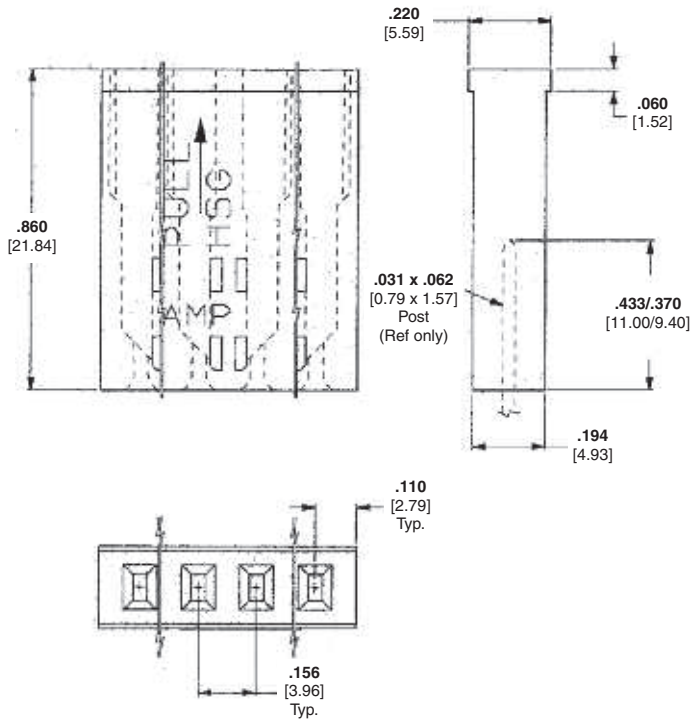

No. of Pos.	Dimensions			Housing Part Nos.		Keyed Positions on Mating Face
	A	B	C	UnKeyed	Keyed	
1	—	—	.200 [5.08]	87270-1	—	—
2	—	—	.376 [9.55]	87270-2	—	—
3	.156 [3.96]	.156 [3.96]	.532 [13.51]	1-87270-3	—	—
3 of 4	.156 [3.96]	.312 [7.92]	.688 [17.48]	—	87270-3	□□■□
4				87270-4	—	—
4 of 5	.312 [7.92]	.312 [7.92]	.844 [21.44]	—	1-87270-0	□□□■□
5				1-87270-4	—	—
5 of 6	.312 [7.92]	.468 [11.89]	1.000 [25.40]	—	1-87270-2	□□□□■□
6				87270-5	—	—
6 of 7	.468 [11.89]	.468 [11.89]	1.156 [29.36]	—	1-87270-1	□□□□■□□
7				1-87270-5	—	—
8	.468 [11.89]	.624 [15.85]	1.312 [33.32]	87270-6	—	—
9	.624 [15.85]	.624 [15.85]	1.468 [37.29]	1-87270-6	—	—
10	.624 [15.85]	.780 [19.81]	1.624 [41.25]	87270-7	—	—
11	.780 [19.81]	.780 [19.81]	1.780 [45.21]	1-87270-7	—	—
12	.780 [19.81]	.936 [23.77]	1.936 [49.17]	87270-8	—	—

■ Indicates "closed cavity". No post entry hole in this position.  
**Notes:** 1. All housings listed above will accept Locking Clip Contacts No. 87269 and 87278, refer to page 298  
 2. Refer to TE Instruction Sheet 408-7676 for proper contact orientation within the housings.

**Note:** All part numbers are RoHS compliant.

## Application Tooling

### For Crimp Snap-In Receptacles and Locking Clip Contacts

### Side-Feed Heavy-Duty Miniature Applicators (Coded HDM)



Interchangeable applicators for crimping products reeled side-by-side on single or dual carrier strips (primarily closed-barrel terminals and open-barrel contacts). Similar design as the end-feed version. All side-feed applicators include a wire stop to help correctly position the wire end in the crimping target area.

For more information, request Instruction Sheet **408-8040**.

### AMP-O-LECTRIC Model "G" Terminating Machines, 354500-1, -9, -11



Semiautomatic bench machines for crimping reeled terminals and contacts, featuring a quiet and reliable direct motor drive, microprocessor controls for ease of setup and operation, and guarding and lighting designed for operator convenience and safety. All models are equipped with either manual or automatic precision adjustment of crimp height. Machine-mounted sensors are available for crimp quality monitoring using conventional miniature-style applicators.

#### Specifications

**Width** — 18.7-25.3 [475-643] depending on applicator type  
**Depth** — 21.5-28.1 [546-713] depending on applicator type  
**Height** — 20 [508]  
**Weight** — 240 lb [110 kg]  
**Electrical** — 120 or 220 VAC, 50 or 60 Hz; 310 VA  
**Air** — 90-110 psi [6.21-7.59 bar], 6 scfm [0.00282 m<sup>3</sup>/s] when required with air-feed applicators  
**Wire Range** — 26-10 AWG [0.12-6 mm<sup>2</sup>] solid or stranded, depending on product applied  
 For more information, request Catalog **65828**, Video **198116**, Catalog **82275 [Crimp Quality Monitor (CQM)]**, Video **198094**.

### AMPOMATOR CLS IV+ Lead-Making Machines, 356500-1, -2, 1213400-1, -2

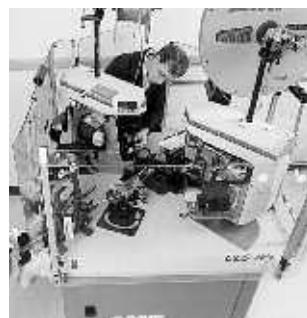

Fully-automatic machines that measure, cut, strip and terminate single leads. Microprocessor-controlled, and programmed and operated using an easy-to-follow, menu-driven touchscreen. Features include direct-drive terminating units with precision crimp height adjustment, fully programmable setups, wire runout and splice detection, and motorized pre-feed with wire straightener. Crimp quality monitoring is also available.

#### Specifications

**Width** — 159 [4 040]  
**Depth** — 68 [1 730]  
**Height** — 86 [2 185] with 24 [610] dia. reel  
**Weight** — 2 000 lb [907 kg]  
**Electrical** — 220 VAC, 50 or 60 Hz, single phase, 25 A, with neutral and ground  
**Air** — 90 psi [6.21 bar], 15 scfm [0.0071 m<sup>3</sup>/s] sustained  
**Wire Range** — 26-10 AWG [0.12-6 mm<sup>2</sup>] stranded, 26-16 AWG [0.12-1.4 mm<sup>2</sup>] solid  
**Lead Lengths** — 3-90 [76.2-2 285], 90-1 000 [2 285-25 400] with long lead conveyors  
 For more information, request Catalog **124324**, Video **198142** (NTSC), **199609** (PAL).

**Note:** All part numbers are RoHS compliant.

**Note:** For additional tooling options, contact TE or reference the TE web site.

**Application Tooling** (Continued)

**For Crimp Snap-In Receptacles and Locking Clip Contacts** (Continued)

**AMP-O-MATIC Stripper-Crimper Machines, 854040-3, -4**



Semiautomatic bench crimping machines that also strip the wire, and are therefore used for terminating jacketed cable. Feature manual precision adjustment of crimp height, keyed strip blades for faster, more accurate setups, and an efficient scrap removal system. All adjustments can be made from the front of the machines without special tools. Available with crimp quality monitoring.

**Specifications**

**Width**—14 [355]  
**Depth**—18 [457]  
**Height**—33 [838] without reel  
**Weight**—150 lb [68 kg]  
**Electrical**—120 VAC, 50 or 60 Hz, .5 A  
**Air**—80-100 psi [5.52-6.90 bar], 3.5 scfm [0.00165 m<sup>3</sup>/s]  
**Wire Range**—32-14 AWG [0.03-2 mm<sup>2</sup>]  
 For more information, request Catalog **65004**, Video **198075**, Catalog **82275 [Crimp Quality Monitor (CQM)]**, Video **198094**.

**Stripper-Crimper Applicators (coded SCA)**



Interchangeable applicators for crimping products in AMP-O-MATIC Stripper-Crimper Machines. Consist of separate ram and lower tooling assemblies. Similar dial-in settings for different wire sizes and insulation diameters as HDM applicators. Available with sensors for use with the Crimp Quality Monitor.

For more information, request Catalog **65004 (AMP-O-MATIC Stripper-Crimper Machines)**, Catalog **82275 [Crimp Quality Monitor (CQM)]**.

**Kappa 235, Automatic Cut and Strip, 3-547178-1**



The Kappa 235 has the capability of processing wires with a cross section of up to 4 AWG and an outside diameter of 0.59 inch. Options include an inner conductor processing kit for multiconductor cables and a flat ribbon cable kit.

**Specifications**

**Width**—25 [630]  
**Depth**—16 [490]  
**Height**—13.4 [370]  
**Weight**—95 lb [44 kg]  
**Wire Cross-Sections**—24-4 AWG [0.22-25 mm<sup>2</sup>]  
**Flat Ribbon Cables**—width up to 40mm  
**Length Range**—0.04"-328ft [1mm - 99.99m] (+/- 0.2%)  
**Electrical**—110/230 V - 50/60Hz, switches automatically

**Cosmic 927R Micro-Cable Stripper**



The Cosmic 927R Micro-Cable Stripper was developed to reliably strip various insulation materials and micro-cable. From conductor diameter 36 AWG to 10 AWG, the stripping diameter display can be set to within 0.1mm increments.

Thus optimal stripping quality is guaranteed and damage to the conductor is eliminated.

**Note:** All part numbers are RoHS compliant.

**Note:** For additional tooling options, contact TE or reference the TE web site.

**Application Tooling** (Continued)

**For Crimp Snap-In Receptacles and Locking Clip Contacts** (Continued)

**CERTI-CRIMP Straight Action Hand Tools (SAHT)**



Premium grade hand tools. Feature ratchet control to provide complete crimp cycle. Die sets close in a straight line. Include a contact locator and wire stop, plus an insulation crimp adjustment lever, when applicable. Approximate weight 1.3 lb [0.59 kg]

All CERTI-CRIMP head assemblies / dies, have multiple power options available. The accompanying diagram outlines those power options. See catalogs 1654714 (SDE Electric Terminator), 124208 (626 Pneumatic Tool System) and 1773381 (Battery-Powered Crimp Tool Kits) for more information.

For more information, request Catalog **65780**.



**PRO-CRIMPER III Hand Tool**



Commercial grade hand tool for crimping various products. Features ratchet control to provide complete crimp cycle. Accepts both pinned- and shouldered-style die sets. Locators are provided with pinned-style die sets for proper contact and wire positioning, and to help minimize contact rotation and bending during crimping. Approximate weight 1.3 lb [0.60 kg].

All PRO-CRIMPER head assemblies / dies, have multiple power options available. The accompanying diagram outlines those power options. See catalogs 1654714 (SDE Electric Terminator), 124208 (626 Pneumatic Tool System) and 1773381 (Battery-Powered Crimp Tool Kits) for more information.

**Instruction Sheet**  
408-9930



**Note:** For additional tooling options, contact TE or reference the TE web site.

**Application Tooling** (Continued)

**For Board Mount Receptacles and Machine Applied Posts**

**Modular Insertion System (MIS) Bench Machines, 217600 Series, 662820 Series (shown)**



For Board Mount Receptacles

Bench machines for inserting a variety of products into pc boards. Uses the same interchangeable insertion heads as the Comp-U-Sertor II Machines. Series 217600 machines feature a manually-operated X-Y positioning fixture, plus a locator spotlight. The machine cycles when the board hole is placed on the anvil and both triggers on the dual handles attached to the X-Y fixture are depressed. Series 662820 machines, without board fixturing, cycle automatically when the hole is properly located. A stabilizing disk over the anvil helps keep the board level.

This benchtop insertion machine installs contacts into PC boards at rates to 2000 per hour. A spotlight highlights the insertion area, and lower tooling assures precise board location. The machine is activated by a foot pedal.

**Specifications**

- Width** — 18 [457]
  - Depth** — 24 [610]
  - Height** — 18 [457]
  - Weight** — 250 lb [113 kg]
  - Electrical** — 120 to 220 VAC, 50 or 60 Hz (217600); 120 or 240 VAC, 60 Hz, single phase, 120 VA (662820)
  - Air** — 80 psi [5.52 bar] min., 15 scfm [0.00708 m<sup>3</sup>/s] min.
  - Insertable Area** — 18 x 22 [457 x 559] max.
- For more information, request Catalog **296059**.

**P300 Automatic Insertion Machine**



Automatic machine for inserting a variety of contacts into pc boards (PCBs). Equipped with an insertion tool (comprised of a product-specific insertion head, an anvil, and a product feed mechanism). Stepper-motor driven X-Y table positions PCBs under insertion head. Surface Mount Equipment Manufacturers Association (SMEMA) compatible inline PCB Insertion Station for posts, tabs, receptacles or sockets. Stand-alone unit is field upgradeable to Pass Through. Mounts up to four TE pneumatic insertion heads. Modem diagnostics standard, vision system optional. Control panel used to program and monitor entire insertion process.

**Specifications**

- Width** — 57.5 [1 460]
  - Depth** — 64.5 [1 640]
  - Height** — 60 [1 520]
  - Weight** — Depending on configuration
  - Electrical** — 110 V, 60 Hz
  - Air** — 87 psi [6 bar]
  - Insertable Area** — 24 x 16 [600 x 400]
- For more information, contact TE.

**Note:** All part numbers are RoHS compliant.

**Note:** For additional tooling options, contact TE or reference the TE web site.

**Application Tooling** (Continued)

**For Board Mount Receptacles and Machine Applied Posts** (Continued)

**P350 Pin Insertion Machine**



The P350 is a fully automatic inline pin insertion machine capable of applying reeled pins, tabs, receptacles and similar products into PCBs. With inline operation, an automatic tool changer and insertion rates up to 5 per second, it is focused at fully automatic high speed operation to maximize throughput while minimizing costly scrap.

A servo powered XY table positions the PCB under a central drive station at high speed. The tool changer can hold up to 3 insertion heads each capable of applying a different product. A unique rotary insertion finger allows the application of products at up to 7 different angles without rotating the PCB. This allows the P350 to apply product at different angles without a reduction in insertion rate or the potential positioning error associated with PCB rotation. Icon driven software with touch screen provides a simple to use, intuitive operator interface.

The P350 provides a wide range of solutions for pin insertion applications. Quick change tooling packs, and a wide range of options make it a flexible high speed platform.

**Specifications**

**Width** — 102 [2600]

**Depth** — 118 [3000]

**Height** — 87 [2200]

**Weight** — approx 3500 lb [1600 kg]

**Electrical** — 230 V, 50-60 Hz, 10 A

**Air** — 600 kPa dried air

**Max. Board Size** — 17.5 x 17.5 [450 x 450]



## Performance Specifications

The electrical, mechanical and environmental characteristics of the AMPMODU .031 x .062 [0.79 x 1.57] Interconnection System are listed below:

### Mechanical Characteristics

#### Contact Durability

Plating	Receptacles		Locking Clip Contacts
	Standard Pressure	High Pressure	
.000016 [0.00041] Min. Tin	75 Cycles	25 Cycles	N/A
.000079 [0.00201] Min. Tin	75 Cycles	25 Cycles	N/A
.000100 [0.00254] Min. Tin	N/A	N/A	25 Cycles
.000015 [0.00038] Gold	75 Cycles	50 Cycles	25 Cycles
.000030 [0.00076] Gold	200 Cycles	100 Cycles	N/A

### Electrical Characteristics

#### Contact Current Rating —

5 amperes max. for single contact in free air, could vary due to ambient temperature, wire size and duty cycles.

#### Contact Resistance —

12 milliohms at 100 ma and 50 mv open circuit.

#### Dielectric Rating —

At Sea Level – 1200 VAC between contacts on .156 [3.96] centers for 1 minute.

**Insulation Resistance** — 5 x 10<sup>3</sup> megohms (initial)

### Connector Durability

#### Receptacles

Mating – 16 oz. [4.45N] max. per contact after 3 mating cycles (standard pressure)

–30 oz. [8.34N] max. per contact after 3 mating cycles (high pressure, gold)

–60 oz. [16.68N] max. per contact after 3 mating cycles (high pressure, tin)

Unmating – 1 oz. [0.28N] min. per contact after 3 mating cycles (standard pressure)

3 oz. [0.83N] min. per contact after 3 mating cycles (high pressure)

#### Locking Clip Contacts

Mating – 4 lb. [17.79N] max. per contact after 3 mating cycles

Unmating – 2 lb. [8.90N] min. per contact after 3 mating cycles

### Environmental Characteristics

**Operating Temperature** — -65°C to 105°C [-85°F to 221°F] (Gold Plated)

-65°C to 60°C [-85°F to 140°F] (Tin Plated)

## Technical Documents

Various technical documents are available for your use:

### Product Specifications

describe technical performance characteristics and verification tests. They are intended for the Design, Component and Quality Engineer.

**108-25016** Interconnection System, Standard Pressure

**108-25025** Interconnection System, High Pressure, Gold

**108-25025-1** Interconnection System, High Pressure, Tin

**108-36029** Locking Clip Connectors

### Application Specifications

describe requirements for using the product in its intended application and/or crimping information. They are intended for the Packaging and Design Engineer and the Machine Setup Person.

**114-25000** Crimp Snap-In Receptacle Contacts

**114-25004** Board Mount Receptacle Contacts

**114-25008** Locking Clip Contacts

**114-25011** Machine Applied Straight Posts

**Instruction Sheets** provide instructions for assembling or applying the product. They are intended for the Manufacturing Assembler or Operator.

**408-7308** Clinching Procedures for Header Assemblies

**408-7411** Suggestions for Wave Soldering AMPMODU Receptacles

**408-7594** TE Hand Tool 90274-2 for Crimping Crimp Snap-In 18-22 AWG Contacts

**408-7750** TE Hand Tool 90328-1 for Crimping Crimp Snap-In Contacts (22-26 AWG)

**408-7676** AMPMODU Locking Clip Connectors and Contacts

**408-7671** TE Hand Tool 90308-1 for Crimping Locking Clip Contacts

**408-7678** TE Extraction Tool 91104-1 for Locking Clip Contacts

**408-7981** Clinching Procedures for Receptacle Assemblies

**408-9451** TE Extraction Tool 843473-1 for Crimp Snap-In Receptacles

**Note:** All part numbers are RoHS compliant.

## Shunts

### Product Facts

- 7600 Series Programmable Shunts use conventional .100 x .300 [2.54x7.62] DIP leg spacing
- Post Shunts are used to common pairs of .025 [0.64] square posts, .025 [0.64] diameter round posts and .022 x .026 [0.56 x 0.66] formed posts

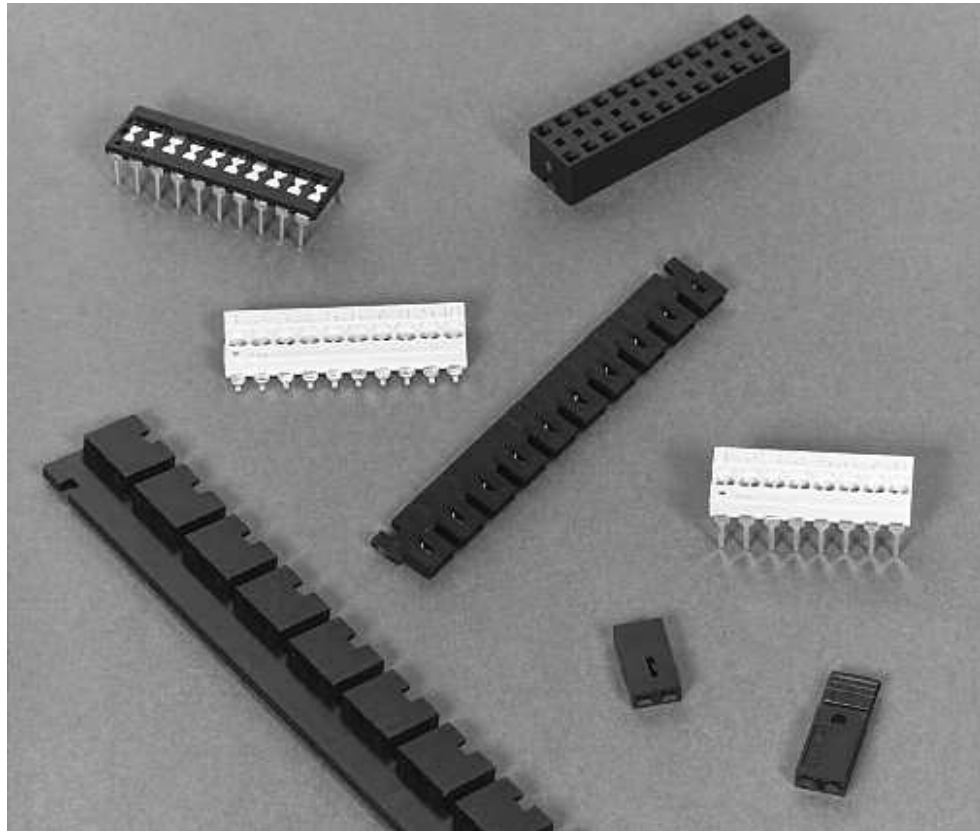

TE offers a variety of high quality shunts for low cost manual programming. TE 7600 Series Programmable Shunts are designed on the standard .100 x .300 [2.54 x 7.62] DIP spacing.

TE DIP Shunts are a highly reliable, low cost means of manually programming various types of electrical/electronic equipment. The shunt consists of a series of conductive straps packaged in a DIP configuration. The straps can be retained intact for a closed circuit or broken with a hand tool to produce an open circuit.

TE Post Shunts mate with any common pairs of square, rectangular and round posts. Post shunts come in two-position low profile, 2 mm miniature, tandem spring, dual beam, and multiposition versions.

Among the options available are choices of gold or tin plating, beryllium copper or phosphor bronze contact material and shunts with 94V-0 rated housing spaces on .079 [2.00], .100 [2.54] and .200 [5.08] centers with the low profile series requiring only .250 [6.35] clearance from the pc board.

All TE shunts feature one-piece construction for high reliability. All have high normal forces for excellent electrical continuity. For added reliability, Tandem Spring and Dual Beam Shunts have two points of contact in each receptacle.

## Dual In-Line Package (DIP) Shunts — 7600 Series

### Standard Shunt Standard Pressure

#### Material and Finish

**Housing** — Glass-filled polyester, UL 94V-0 rated

**Contacts** — Brass

**Finish** — Selectively plated .000100 min. tin on solder area over .000050 min. nickel on entire contact

**Contact Lead Spacing** — .100 x .300 [2.54x7.62]

**Lead Length** — .140 [3.56] below mounting surface

**Housing Color** — Black

**Programming Tool** — See below

#### Programming Hand Tool

Part No. 435862-1



This tool provides a reliable means of programming DIP shunts. It is rugged, light-weight and dependable. No special skills are required to use this tool.

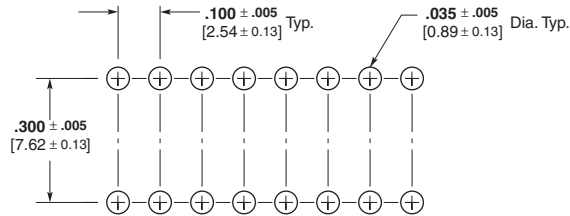
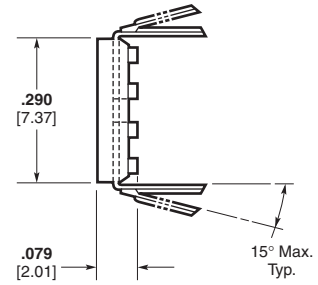
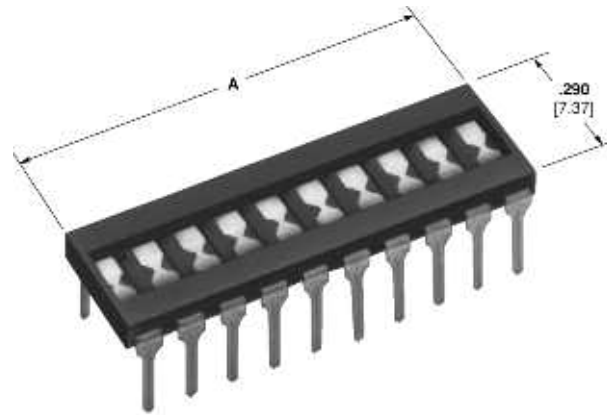

No. of Pos.	Dimension A		Standard Shunt Standard Pressure
	inch	mm	
4	.400	10.16	1825190-4
6	.600	15.24	1825190-6
7	.700	17.78	1825190-7
8	.800	20.32	1825190-8
9	.900	22.86	1825190-9
10	1.000	25.40	1-1825190-0
12	1.200	30.48	1-1825190-2

**Note:** All part numbers are RoHS compliant.

## Post Shunts

### Product Facts

- One-piece contact construction
- High normal forces
- 94V-0 rated housings
- Gold inlay, gold plate or tin plate over nickel
- Stackable
- Those post shunts indicated are recognized under the component program of Underwriters Laboratories Inc., File No. E28476 and certified by the Canadian Standards Association File No. LR 7189



### 2-Position, Low Profile Shunts

Economy Shunt  
.100 [2.54] Centerline

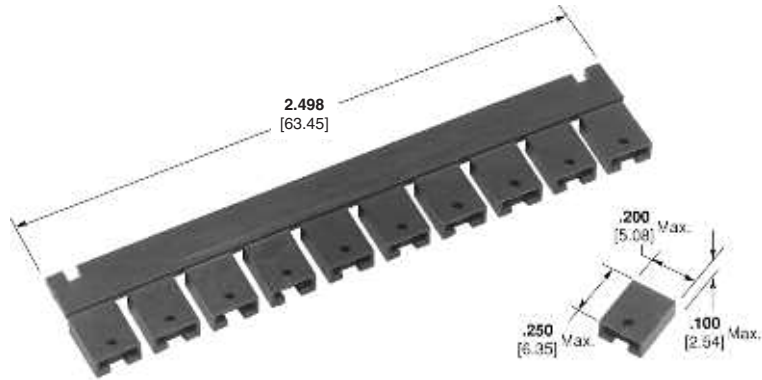

Configuration	Housing Color	Part Numbers			
		Gold Plate <sup>1</sup> .000015 [0.00038]	Gold Flash <sup>1</sup> .000005 [0.00013]	Tin Plate .000100 [0.00254]	Gold Plate .000030 [0.00076]
Strip of 10	Blue	382811-2	—	—	—
Strip of 10	Black	382811-6	382811-8	382811-5	2-382811-0
Strip of 10	Red	382811-9	—	—	—
Loose Piece	Black	1-382811-6	1-382811-8	—	—

<sup>1</sup>In contact area

### Tandem Spring Shunts

- Two points of contact provide extra reliability
- Shunts accept posts as short as .175 [4.45]; posts bottom at .330 [8.38]

### 2mm Mini Shunts

- Stackable on 2mm contact centerline
- Low profile
- Available in strips of 10

Standard Housing Shunt  
.200 [5.08] Centerline

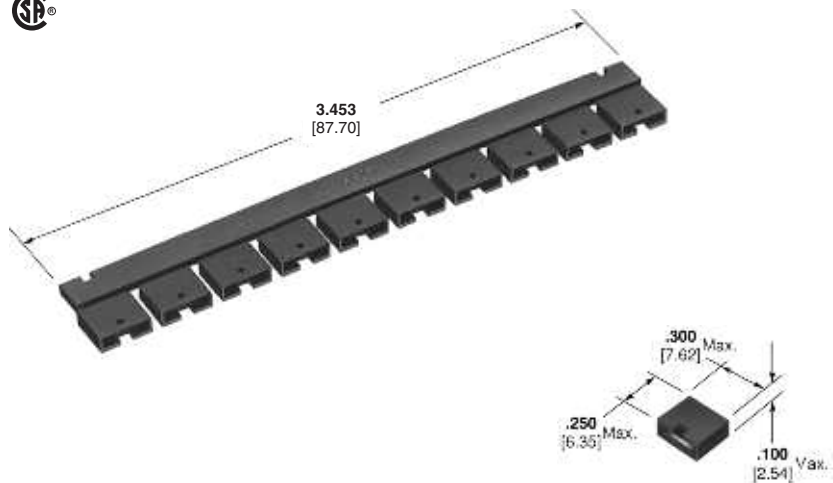

Configuration	Housing Color	Part Numbers		
		Gold Plate <sup>1</sup> .000015 [0.00038]	Gold Plate <sup>1</sup> .000030 [0.00076]	Tin Plate .000100 [0.00254]
Strip of 10	Black	531230-2	531230-3	531230-1

<sup>1</sup>In contact area

### Material and Finish — Low Profile and 2mm Shunts

**Housing** — Glass-filled thermoplastic, black, UL 94V-0 rated

**Contacts** — Beryllium copper or phosphor bronze, plated .000050 [0.00127] nickel underplate with gold plate in contact area or tin overall

### Material and Finish — Tandem Spring Shunts

**Housing** — Nylon, UL 94V-0 rated

**Contacts** — Phosphor Bronze

**Finish** — .000030 [0.00076] nickel underplate with gold inlay in the contact area or tin overall

**Note:** All part numbers are RoHS compliant.

**Post Shunts** (Continued)

**2-Position, Low Profile Shunts (Novo)**  
(Continued)

**Handle Shunt**  
**.100 [2.54] Centerline**

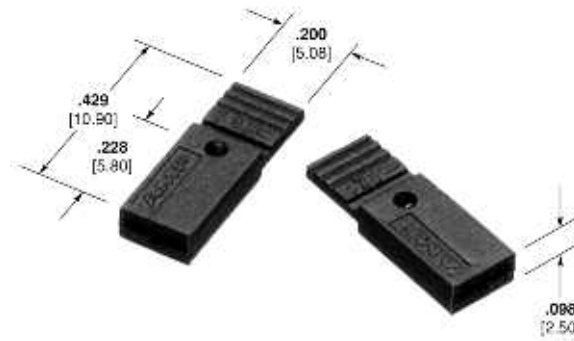

Housing Color	Loose Piece Part Numbers				Type
	Gold Plate <sup>1</sup> [0.00038]	Gold Plate <sup>1</sup> [0.00076]	Gold Plate <sup>1</sup> [0.00127]	Tin Plate [0.00254]	
Black	881545-1	881545-2	881545-3	4-881545-2	Open Top
Black	880584-1	880584-2	880584-3	880584-4	Closed Top

<sup>1</sup>In contact area

**2 mm Mini-Shunt**  
**.079 [2.00] Centerline**

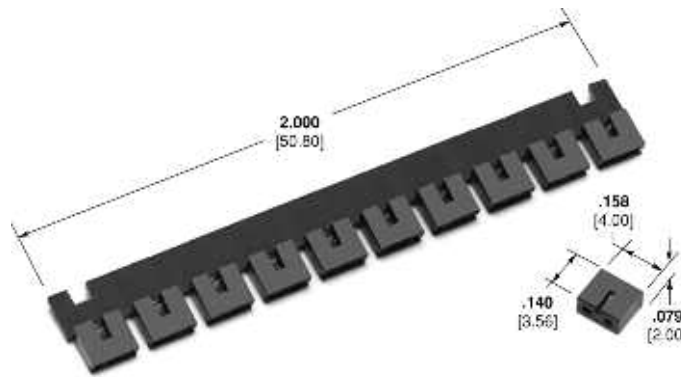

Configuration	Housing Color	Part Numbers	
		Gold Plate <sup>1</sup> [0.00038]	Gold Plate <sup>1</sup> [0.00076]
Strip of 10	Black	382575-2	382575-3

<sup>1</sup>In contact area

**Dual Beam Shunt**

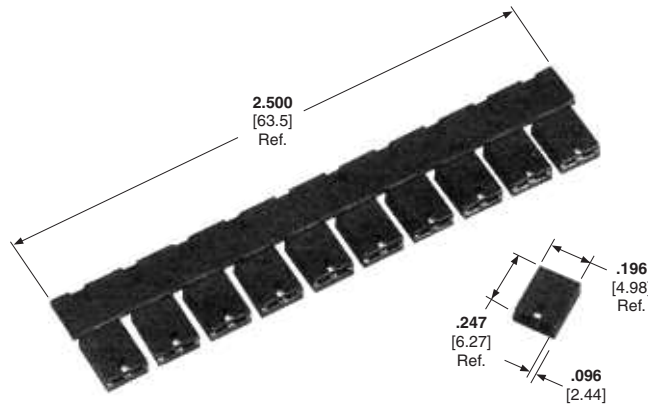

Configuration	Housing Color	Part Numbers		Type
		Gold Plate <sup>1</sup> [0.00038]	Gold Plate <sup>1</sup> [0.00076]	
Strip of 10	Black	390088-2	390088-1	Open Top
Strip of 10	Blue	390088-4	390088-3	Open Top
Strip of 10	Yellow	—	390088-5	Open Top

<sup>1</sup>In contact area

**Note:** All part numbers are RoHS compliant.

**Post Shunts** (Continued)

**Tandem Spring Shunt**

.100 [2.54] Centerline

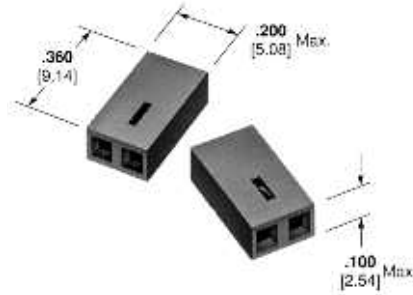

Housing Color	Part Numbers	
	Gold Inlay <sup>1</sup>	TinPlate
	.000030 [0.00076]	.000100 [0.00254]
Black	530153-2	4-530153-1

<sup>1</sup>In contact area

**Multiposition Shunts for .025 [0.64] Square Posts**

.200 [5.08] Centerline



**Housing** — Glass-filled polyester  
**Contacts** — Beryllium Copper  
**Finish** — .000030 [0.00076] gold in contact area over .000050 [0.00127] nickel on entire contact  
**Current Rating** — 2.5 amps

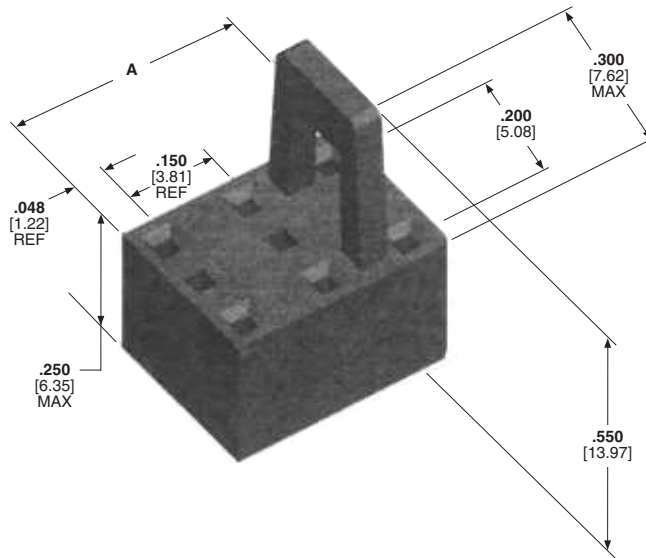

Size	Dimension A		Housing Color	Part Number
	inch	mm		
2x2	.246	6.25	Black	390102-1
2x2	.246	6.25	Red	390102-3
2x3	.396	10.01	Black	390102-2

**Note:** All part numbers are RoHS compliant.

## Performance Specifications

### Dual In-Line Package (DIP) Shunts — 7600 Series

**Current Rating** —

Standard pressure — 2 amperes for +20°C rise above ambient (one conductor per shunt)  
Machine insertable — 1 ampere for +20°C rise above ambient (one conductor per shunt)

**Insulation Resistance** —  $1 \times 10^{10}$  ohms min. at 100 VDC**Dielectric Withstanding Voltage** — 500 VDC min.**Capacitance** — 2 picofarads max. between adjacent straps**Temperature Rating** — -55°C to +105°C**Terminal Strength (Bend Test)** — Two 45° bend cycles per MIL-STD-202, Method 211, Condition B**Solder Bridging** —

Cut straps can be reconnected by solder bridging. Solder bridging recommendations are:

- Use low temperature solder (60/40 tin/lead)
- Use solder tip approximately 1/32 [0.79] in diameter
- Do not let solder tip come in contact with plastic material

### Post Shunts

**Current Rating** —

3 amperes max. unless otherwise noted

**Temperature Rating** — -65°C to +105°C (gold) -40°C to +85°C (tin)

## Technical Documents

Various technical documents are available for your use:

**Product Specifications** describe technical performance characteristics and verification tests. They are intended for the Design, Component and Quality Engineer.

108-7533	Dual In-Line Package (DIP) Shunts
108-1445	2mm Mini Shunt
108-1476	Economy Shunt, Multiposition Shunt
108-1674	Dual Beam Shunt
108-9057	Low Profile Shunt
108-9062	Tandem Spring Shunt
108-37006	Novo Shunt with Handle

**Application Specifications** describe requirements for using the product in its intended application and/or crimping information. They are intended for the Packaging and Design Engineer and the Machine Setup Person.

114-1045	Tandem Spring Shunt
114-1054	Dual In-Line Package (DIP) Shunts
114-1059	Economy Shunt, Dual Beam Shunt, Low Profile Shunt, Multiposition Shunt
114-1074	2mm Mini Shunt

**Instruction Sheets** provide instructions for assembling or applying the product. They are intended for the Manufacturing Assembler or Operator.

408-7768	Dual In-Line Package (DIP) Shunts
408-3208	Tandem Spring Shunt
408-3230	Economy Shunt, Dual Beam Shunt, Low Profile Shunt
408-3251	Multiposition Shunt
408-3276	2mm Mini Shunt

## Engineering Notes



8



### Part Number Index

**Note:** This index lists all cataloged parts by base no. only. Complete part nos. (with prefixes and/or suffixes) are shown on the page(s) indicated.

Part No.	Page	Part No.	Page	Part No.	Page
19156	139, 140	87227	85, 96, 97	102104	290
57013	58	87230	85, 98, 99	102106	290
57038	58	87232	85, 94, 95, 210, 221	102107	211
57118	58	87233	94, 95	102114	203
57119	58	87247	295	102128	210, 213
57131	58, 59	87258	297	102185	255, 258, 259
57138	58	87262	295	102198	139, 140
57139	58	87269	298	102202	115, 210
57144	58	87270	299	102203	85, 116
57145	58	87278	298	102241	210, 215
57288	58	87283	296	102312	258, 259
57289	58	87309	213	102316	213
57290	58	87316	286	102338	203
85487	286	87456	210, 216	102348	211
85493	286	87474	129	102387	210, 220
85829	295	87483	210	102393	256
85839	296	87496	133	102394	256
85840	296	87499	210, 214	102395	265
85875	296	87523	213	102396	255, 259
85923	296	87568	127	102398	255, 256
85969	213	87572	126	102399	265
86016	213	87577	124, 125	102448	256
86147	294	87579	122, 123	102449	265
86177	216	87587	119, 120	102523	116
86181	285, 287, 288	87589	117, 118	102536	255, 259
86182	294	87605	85, 131	102537	255, 259
86207	296	87608	130	102540	255, 259
86286	169, 172, 175-177, 180, 182, 189, 191, 195-197, 214-218, 220, 256, 257	87623	163	102541	255, 259
86432	286	87631	210, 218, 219	102548	213
86434	286	87654	297	102557	149
86477	286	87655	297	102567	198
86479	98, 99	87666	213	102570	124, 125
86480	286	87667	213	102589	193, 200
86492	213	87710	218	102617	122, 123
87003	286	87733	219	102618	117, 118
87022	163	87743	204	102619	119, 120
87025	291	87756	210, 213	102620	127
87046	213	87772	286	102641	265
87077	214-218, 220, 256, 257	87774	286	102642	265
87105	286	87809	213	102666	199
87107	211	87878	163	102681	255, 259
87116	293	87879	85, 177	102690	193, 199
87124	207	87921	218	102691	199
87131	209	87922	218, 219	102692	198
87132	209	87977	210, 217	102693	257
87133	209	87983	287	102694	257
87159	293	87984	287	102695	257
87160	295	87985	287	102699	85, 148
87165	207	87986	287	102742	177
87175	208	87987	289	102766	142
87176	209	87988	289	102777	199
87179	208, 209	87989	287	102783	262, 263
87190	207	87990	287	102784	262, 263
87191	207	87993	287	102785	262, 263
87194	297	87995	289	102786	262, 263
87195	213	102055	126	102787	262, 263
87215	96, 97	102090	292	102788	262, 263
87220	85, 93	102095	211	102789	263
87224	93	102099	290	102791	264
		102100	290	102792	264
		102102	290	102802	200
		102103	290	102823	259

**Part Number Index** (Continued)

Part No.	Page	Part No.	Page	Part No.	Page	Part No.	Page
102826	144	103639	245	103960	231	104895	19
102871	143	103640	231	103961	231	104905	208
102898	146	103641	231	103968	233	104909	245
102903	263	103644	231	103969	233	104910	245
102917	213	103645	231	103970	233	104935	247
102918	213	103648	233	103971	233	111196	56
102920	213	103649	233	103972	233	146079	163
102935	280	103650	233	103973	233	146128	109
102972	107	103651	233	103974	229	146129	109
102973	107	103652	233	103975	229	146130	110
102976	107	103653	237	103976	229	146131	110
102977	107	103654	239	103977	229	146132	86, 109
102985	263	103655	239	103978	229	146133	109
102987	261, 263	103656	239	103979	229	146134	86, 110
102988	261, 263	103657	239	104068	30	146135	110
102991	264	103658	237	104069	29	146138	178
103056	281	103659	237	104071	28	146205	202
103058	281	103660	237	104074	27	146250	104, 107
103080	115	103661	237	104076	31	146252	104, 107
103136	261, 263	103669	245	104078	40	146253	104, 107
103137	261, 263	103672	247	104118	34	146254	104, 107
103138	262, 263	103673	247	104178	33	146256	104, 107
103139	262, 263	103680	240	104186	32	146257	85, 104, 107
103140	262, 263	103681	241	104192	38	146258	104
103141	262, 263	103682	242	104196	37	146260	104
103152	261, 263	103684	229	104257	221, 231	146261	104
103153	261, 263	103685	229	104271	261, 263	146262	104
103157	261, 263	103686	229	104272	261, 263	146264	104
103158	261, 263	103687	229	104317	121	146265	104
103164	85, 126	103688	221, 229	104319	128	146266	104
103165	127	103734	231	104361	250	146268	85, 104
103166	85, 122, 123, 210, 255	103735	245	104362	245	146269	104
103167	124, 125	103817	86, 100	104363	245	146270	104
103168	85, 117, 118, 210, 255	103893	237	104438	234	146272	104
103169	119, 120	103894	237	104439	234	146273	104
103171	213	103895	239	104450	221, 248	146274	102, 107
103185	107	103896	239	104477	29	146276	102, 107
103186	107	103897	231	104479	221, 222, 253	146277	102, 107
103233	147	103900	233	104480	221, 222, 253	146278	102, 107
103239	107	103901	233	104481	221, 222, 253	146280	102, 107
103240	107	103902	229	104482	221, 223	146281	85, 102, 107
103264	193, 201	103903	229	104483	224	146282	102
103268	259	103904	247	104500	241	146284	102
103291	199	103908	245	104503	239	146285	102
103321	107	103911	39	104505	254	146286	102
103322	107	103916	35	104506	254	146288	102
103327	107	103944	237	104549	44	146289	102
103328	107	103945	237	104550	45	146290	102
103336	85, 146	103946	237	104583	282	146292	102
103340	261, 263	103947	237	104584	282	146293	85, 102
103341	261, 263	103948	237	104652	15	146294	102
103349	281	103949	237	104655	16	146296	102
103350	281	103950	239	104656	16	146297	102
103361	116	103951	239	104666	30	146304	85, 103
103414	85, 115	103952	239	104693	16	146305	103
103455	213	103953	239	104744	40	146306	85, 103
103542	85, 147	103954	239	104804	28	146307	103
103577	85, 163	103955	239	104809	249	146308	85, 105
103634	247	103956	231	104891	22	146309	105
103635	247	103957	231	104892	21	146310	105
		103958	231	104893	21	146311	105
		103959	231	104894	19	146315	202

**Part Number Index** (Continued)

Part No.	Page	Part No.	Page	Part No.	Page	Part No.	Page
146386	175	146852	107	147740	192	1375582	252
146427	85	146853	107	147741	192	1375583	252
146455	112	146858	107	147742	187	1375791	7, 12
146456	112	146859	107	147743	187	1375792	7
146457	112	146860	107	147744	187	1375793	7, 12
146458	112	146861	107	147745	190	1375794	7
146459	112	146868	107	147746	190	1375795	6, 12
146460	112	146869	107	147747	190	1375796	6
146461	112	146870	107	173144	155, 156	1375797	9
146462	112	146871	107	173145	155, 157, 158, 159	1375798	9
146463	112	147030	235	173146	155, 160, 161	1375799	8
146464	112	147070	86, 167	219054	58	1375800	8
146465	112	147071	167	219055	58	1375801	12
146466	112	147072	167	219137	58	1375959	10
146467	112	147095	183, 184	219138	58	1375961	10
146468	112	147096	183, 184	219253	58	1375963	10
146469	112	147099	182	382575	309	1375965	11
146470	112	147100	182	382811	308	1375967	11
146471	112	147101	190	390088	309	1445251	12
146472	112	147102	190	390102	310	1445439	12
146473	112	147103	190	487544	50	1445440	12
146474	86, 112	147104	192	487545	50	1445441	12
146475	112	147105	86, 192	487547	48	1470108	79
146476	112	147106	192	487576	54	1470109	78
146477	112	147121	16	487923	48	1470209	80
146478	112	147254	202	487937	52	1470213	66
146479	112	147278	251	487938	52	1734493	75
146480	112	147323	251	487940	48	1734506	81
146481	112	147324	251	487941	48	1734507	67
146482	112	147326	177	499991	205	1734508	66
146483	113	147333	86, 165	530153	310	1734516	84
146484	113	147334	165	530554	267	1734531	83
146485	113	147335	165	530901	269	1734569	77
146486	113	147377	44	530902	268	1734606	82
146487	113	147378	45	531226	267, 268	1734770	73
146488	113	147381	16	531230	308	1825190	307
146489	113	147382	16	532955	195	1825851	139, 140, 210
146490	85, 113	147383	16	532956	193, 195	2041068	76
146491	113	147384	15	533009	195	2041069	84
146492	113	147396	235	534204	195	5084476	71
146493	113	147413	15	534206	85, 176	5084780	74
146494	113	147424	176	534237	85, 175	5086147	294
146495	113	147433	165	534245	200	5086182	294
146496	113	147434	165	534257	198	5102084	170
146497	113	147435	165	534258	201	5102154	139, 210, 255
146498	113	147436	167	534267	85, 182	5102156	139
146499	113	147437	167	534972	193, 196	5102160	140
146500	113	147438	167	534974	193, 197	5102162	140
146501	113	147503	16	534975	195	5103308	135
146502	113	147720	86, 181	534978	198	5103309	135
146503	113	147723	188	534998	85, 179, 180	5103310	136
146504	113	147724	187	535541	85, 178	5103311	136
146505	113	147726	181	535542	86, 183, 184	5104338	137
146506	113	147727	181	535584	178	5104340	138
146507	113	147728	188	535585	179, 180	5111595	57
146508	113	147729	188	535598	179, 180	5146139	169
146509	113	147730	187	746383	139, 140	5146140	170
146510	113	147731	187	867052	207	5147721	86, 172
146762	176	147736	188	880584	309	5147722	86, 173
146763	175	147737	188	881545	309	5147732	172
146850	107	147738	86, 188	966926	72	5147733	172
146851	107	147739	192	1375549	252	5147734	173

**Part Number Index** (Continued)

Part No.	Page	Part No.	Page	Part No.	Page	Part No.	Page
5147735	173	5178751	70	5531216	269	5535512	85, 170
5176264	70	5530553	269	5531224	269	5535676	85, 169
5176837	68	5530901	269	5531225	269	5535677	169

**Tooling Part Number Index**

**Note:** This index lists all cataloged parts by base no. only. Complete part nos. (with prefixes and/or suffixes) are shown on the page(s) indicated.

Part No.	Page	Part No.	Page	Part No.	Page
58062	273	104072	253	527116	263
58074	273	217600	153, 164, 166, 303	543518	23
58075	273	224910	48, 60	547178	301
58336	273	265871	152	565967	286
58338	273	265964	152	567239	254
58342	254	308554	152	567296	222, 253
58395	273	312522	274	567297	222, 253
58540	273	318619	48, 60	567298	222, 253
58641	211, 213	354500	300	567307	211
90273	60	354786	275	567310	207
90274	290	356484	60	662820	303
90295	207	356500	300	679167	62
90308	298	380392	152	679996	207
90328	290	466007	298	758030	162
90381	211	466376	286	761420	275
90431	207	466562	213	768338	62
91047	60	466571	213	812665	263
91084	207	466655	213	843473	290
91085	62	466721	207	843477	253, 254, 265
91104	298	466723	269	843996	214, 215, 216, 217, 218, 219, 220
91112	62	466763	290	854040	301
91169	152	466764	290	854449	274
91170	152	466812	211	856002	274
91171	152	466819	269	856675	273
91200	60	466905	213	904507	163
91295	23	466918	213	904590	163
91410	263	466921	213	904591	163
91419	163	466937	290	904592	163
91516	213	466943	269	904640	166
91517	211, 213	466950	298	904641	164
91518	222, 253	466952	269	907459	162
91531	254	466980	222, 253	931800	273
91533	207	466981	222, 253	1213400	300
91541	213	466982	222, 253		
91551	222, 253	466983	254		

## Engineering Notes

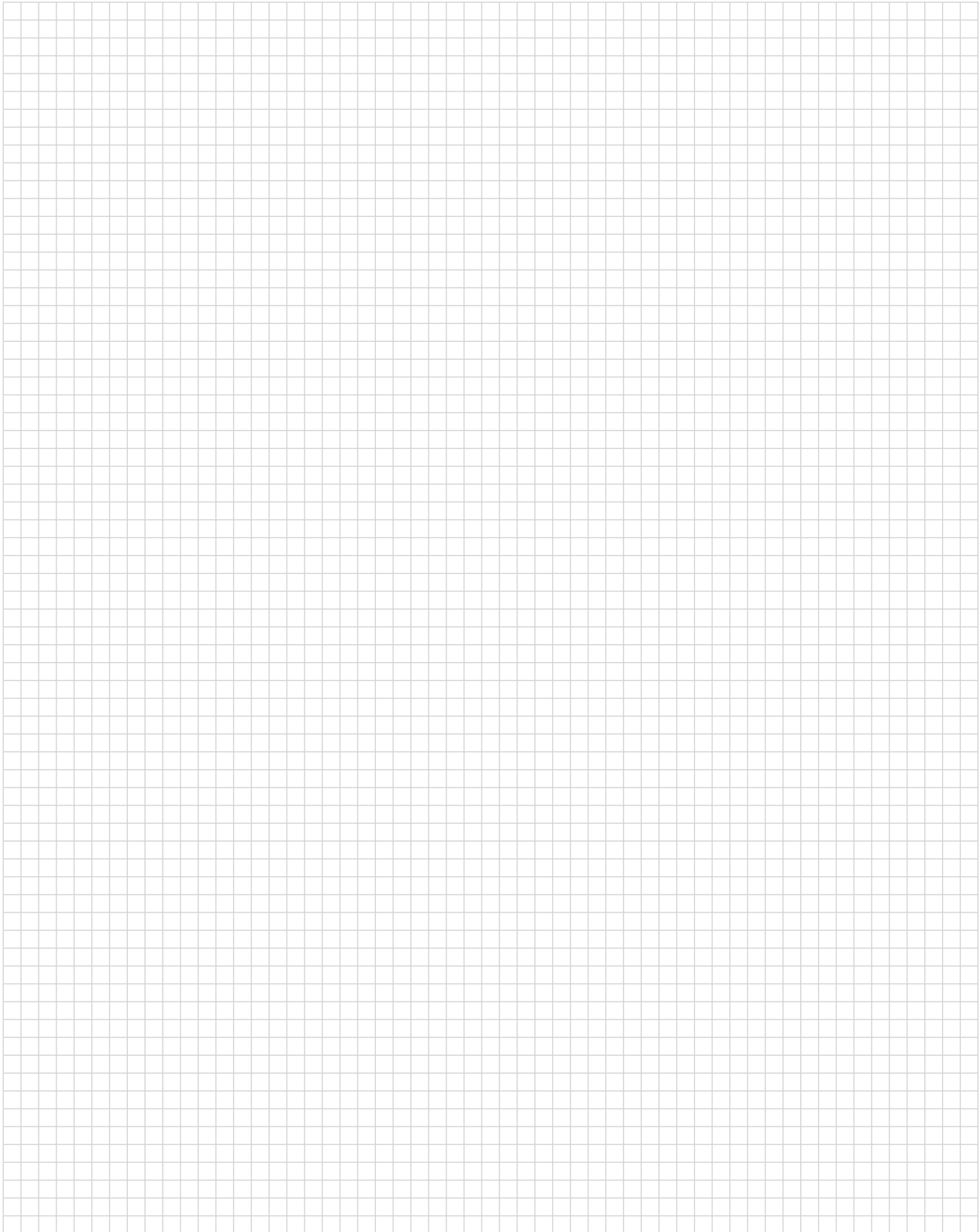

---

**Engineering Notes**

---

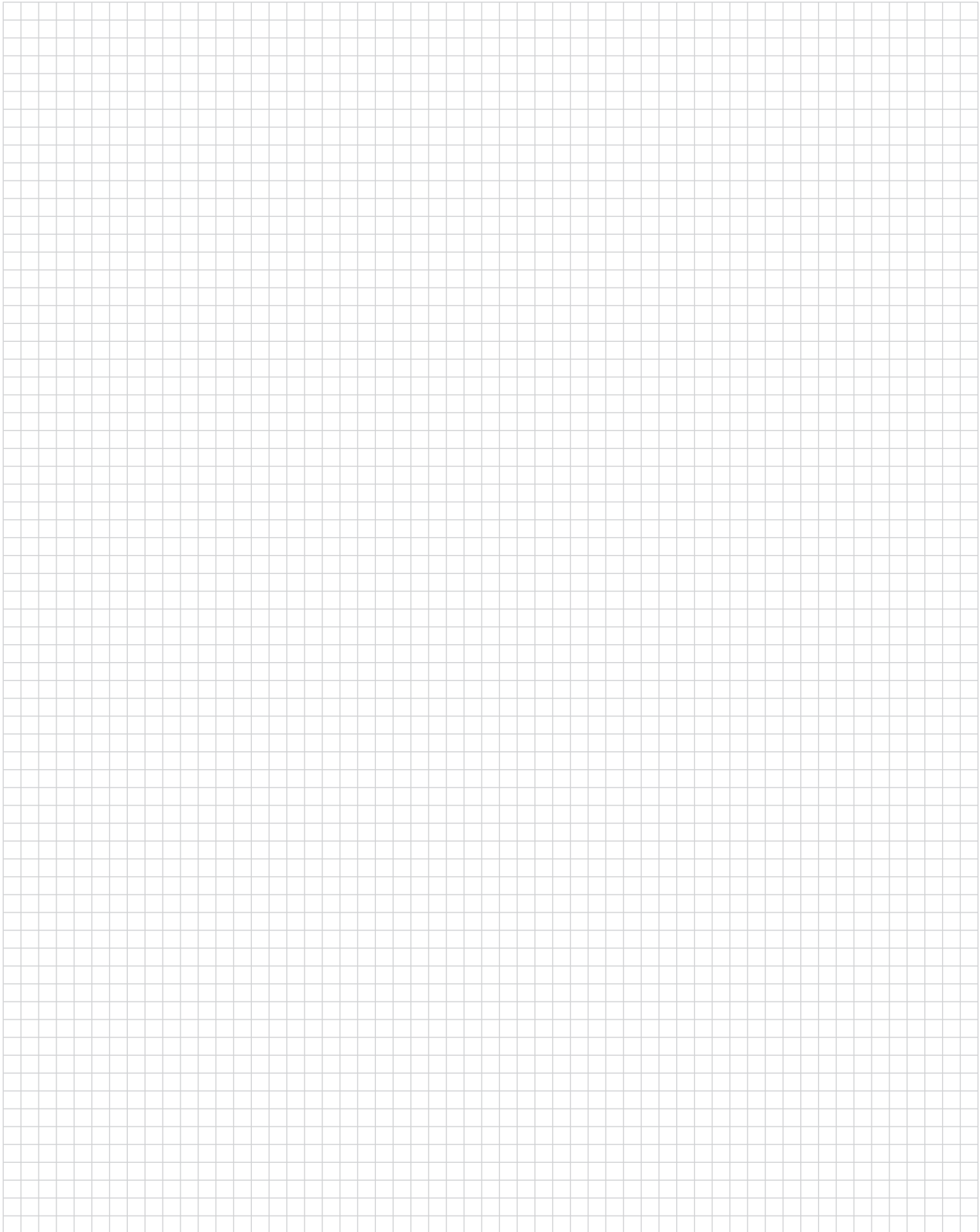

---

**Engineering Notes**

---

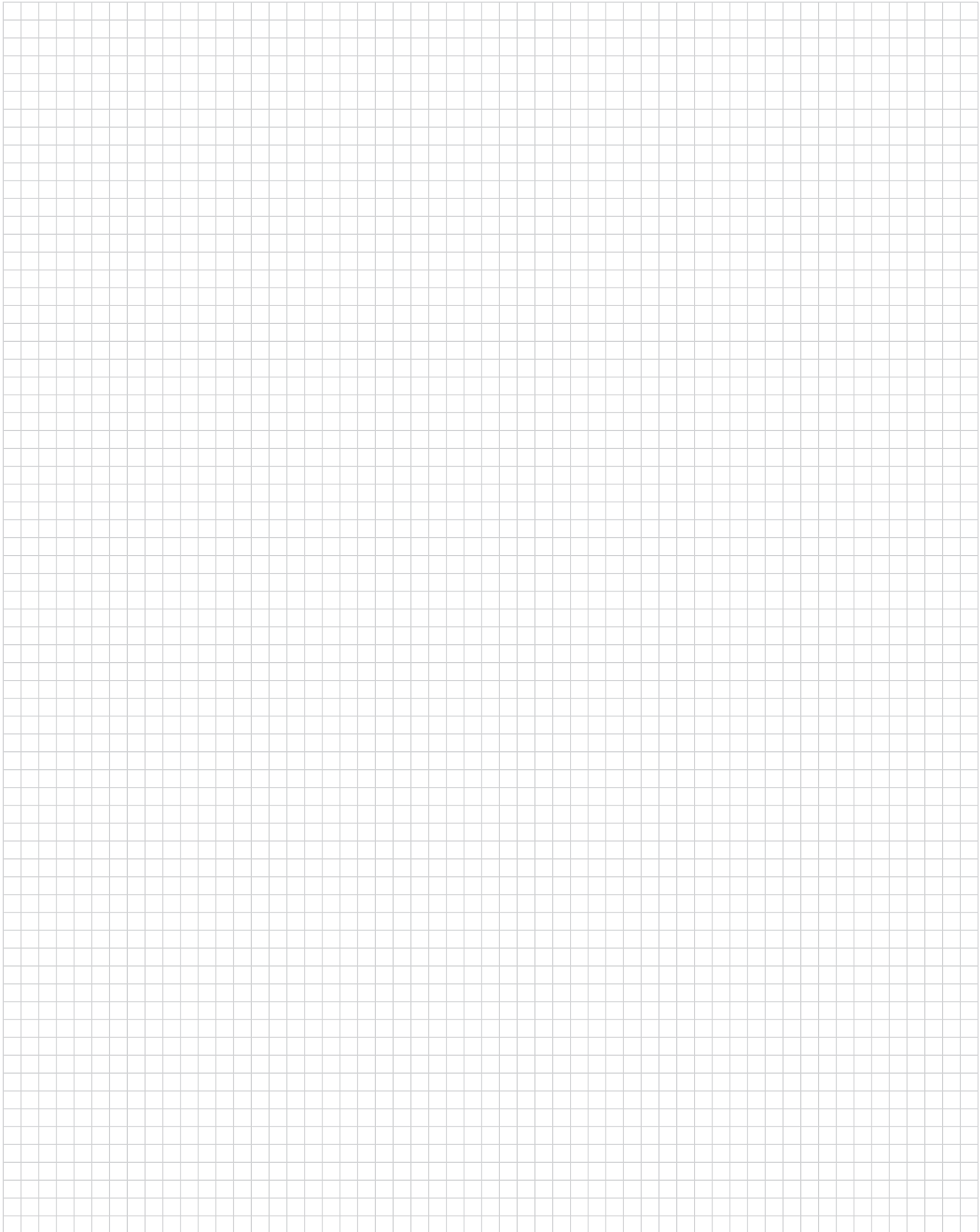

## Engineering Notes

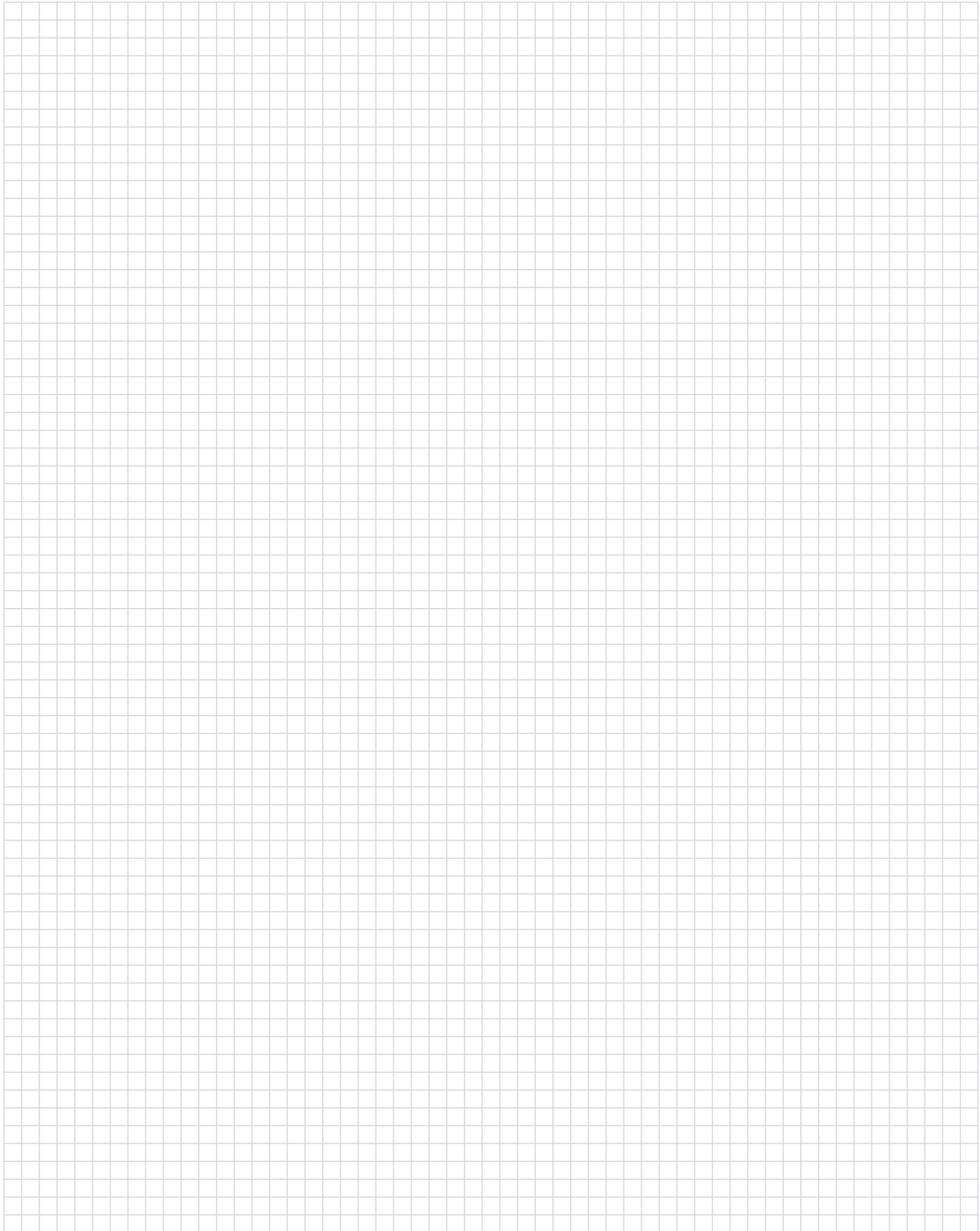



## FOR MORE INFORMATION

[te.com/products/AMPMODUSystem50](http://te.com/products/AMPMODUSystem50)

[te.com/products/AMPMODUMTE](http://te.com/products/AMPMODUMTE)

### TE Technical Support Center

Internet:	<a href="http://te.com/help">te.com/help</a>
USA:	+1 (800) 522-6752
Canada:	+1 (905) 475-6222
Mexico:	+52 (0) 55-1106-0800
Latin/S. America:	+54 (0) 11-4733-2200
Germany:	+49 (0) 6251-133-1999
UK:	+44 (0) 800-267666
France:	+33 (0) 1-3420-8686
Netherlands:	+31 (0) 73-6246-999
China:	+86 (0) 400-820-6015

Part numbers in this brochure are RoHS Compliant\*, unless marked otherwise.

\*as defined [www.te.com/leadfree](http://www.te.com/leadfree)

### te.com

© 2011 Tyco Electronics Corporation, a TE Connectivity Ltd. Company. All Rights Reserved.

1307819 CIS WR 08/2011

AMP, ACTION PIN, AMP-LATCH, AMP-O-ELECTRIC, AMP-O-MATIC, AMPLIMITE, AMPMODU, AMPOMATOR, CERTI-CRIMP, CHAMPOMATOR, PRO-CRIMPER, R-CAM, TE Connectivity and the TE connectivity (logo) are trademarks. Teflon is a trademark of E.I. du Pont de Nemours and Company.

Other logos, product and Company names mentioned herein may be trademarks of their respective owners.

While TE has made every reasonable effort to ensure the accuracy of the information in this catalog, TE does not guarantee that it is error-free, nor does TE make any other representation, warranty or guarantee that the information is accurate, correct, reliable or current. TE reserves the right to make any adjustments to the information contained herein at any time without notice. TE expressly disclaims all implied warranties regarding the information contained herein, including, but not limited to, any implied warranties of merchantability or fitness for a particular purpose. The dimensions in this catalog are for reference purposes only and are subject to change without notice. Specifications are subject to change without notice. Consult TE for the latest dimensions and design specifications.



单击下面可查看定价，库存，交付和生命周期等信息

[>>TE Connectivity\(泰科\)](#)