



5G/4G/3G/2G, NB-IoT, Cat-M, GNSS, Wi-Fi 6 WORLD BAND ANTENNA

Part Numbers: 2195889-1, 2195889-2

FEATURES & BENEFITS

- Wide Band coverage: LTE, 5G, NB-IoT, Cat-M, GNSS and Wi-Fi 6 Dual Band
- 90 degree hinge type SMA terminal mount
- No matching circuits required
- Similar performance for connection via coax cable and coax connector on PCB

SPECIFICATIONS

Frequency Range (MHz)	617 - 960	1427-1661	1710-2700	3300-4200	4400-5000	5150-5925
VSWR	< 2.3:1	< 3.7:1	< 2.9:1	< 2.4:1	< 2.1:1	< 2.0:1
Average Efficiency	47 %	63 %	76 %	74 %	64 %	65 %
Peak Gain	1.6 dBi	2.5 dBi	3.7 dBi	1.9 dBi	2.1 dBi	4.5 dBi
Average Gain	-3.3 dBi	-2.3 dBi	-1.3 dBi	-1.3 dBi	-2.0 dBi	-1.9 dBi
Power Handling	10 Watt cw					
Feed Point Impedance	50 ohms unbalanced					
Polarization	Linear					
Size	19.91mm x 135.80 mm (Unfolded) 19.91mm x 115.00 mm (Folded)					
Weight	< 16 g					
Mounting	SMA Male Terminal mount					
Mating Connectors	SMA Female					
Operating Temperature	-40 to +85°C					
Storage Temperature	-40 to +85°C					
Packaging Specification	Bag & Box					
Hazardous Materials	A certificate of conformance is available from the product page on TE website.					

Data measured in free space with hinge at 90 degree bend

RF DATA

VSWR

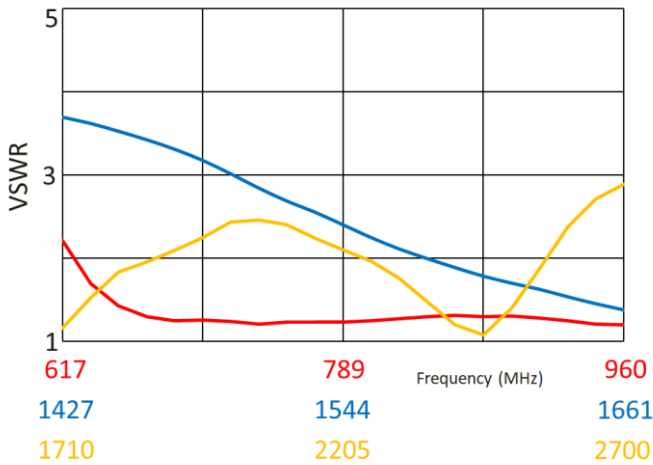

Return Loss

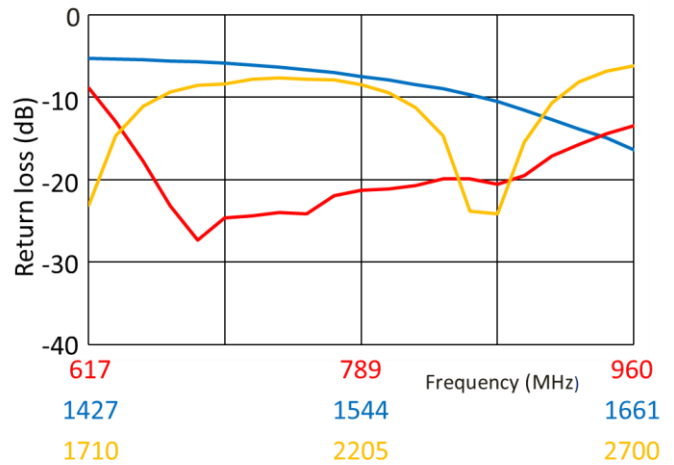

Efficiency

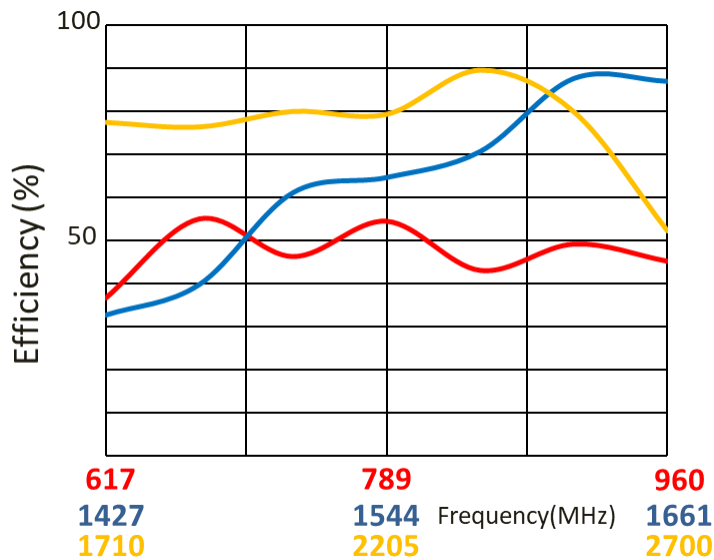

Data measured in free space with hinge at 90 degree bend

RF DATA

VSWR

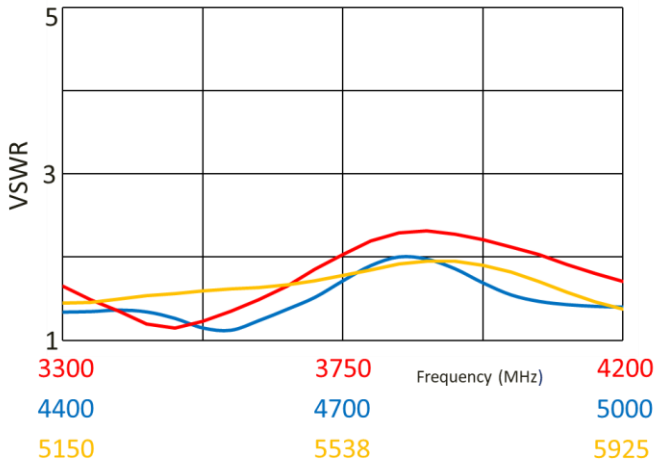

Return Loss

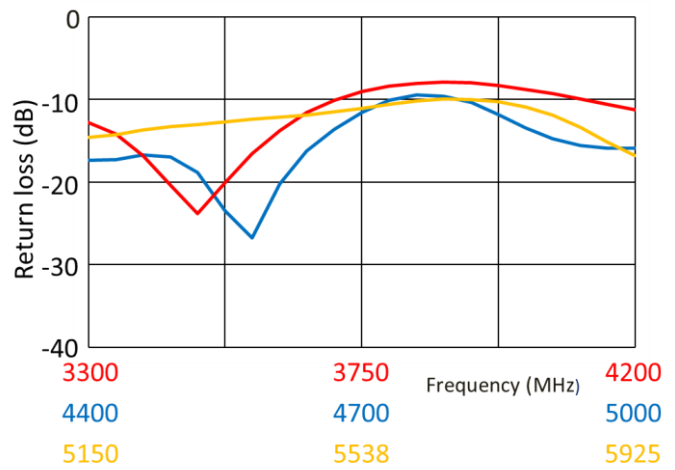

Efficiency

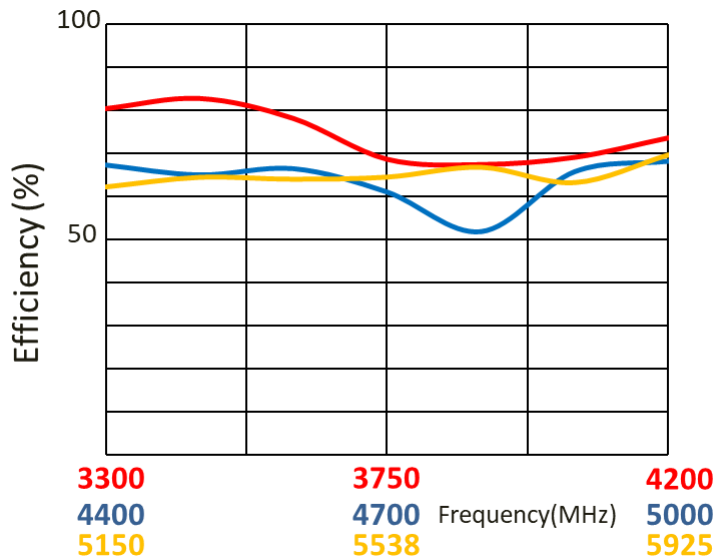

Data measured in free space with hinge at 90 degree bend

RADIATION PATTERN

Test setup

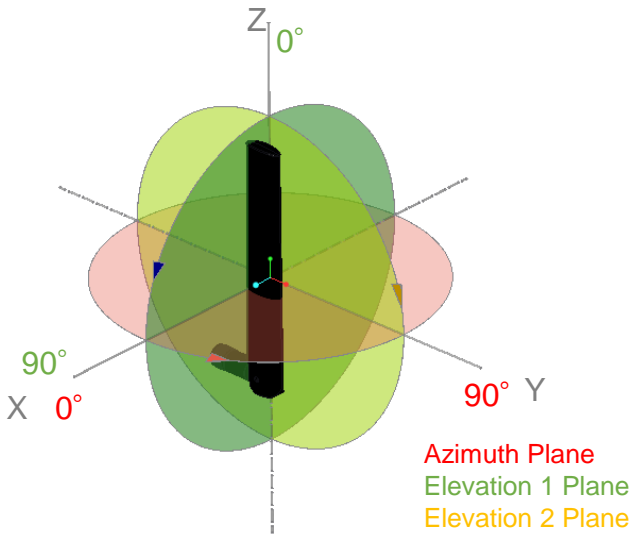

Azimuth

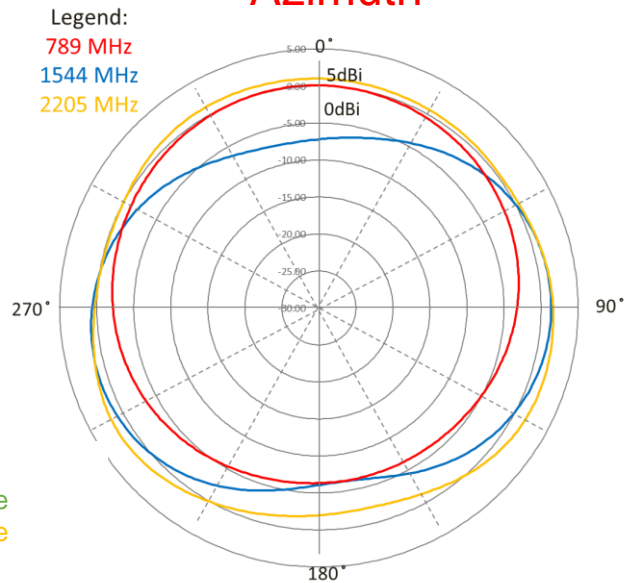

Elevation 1

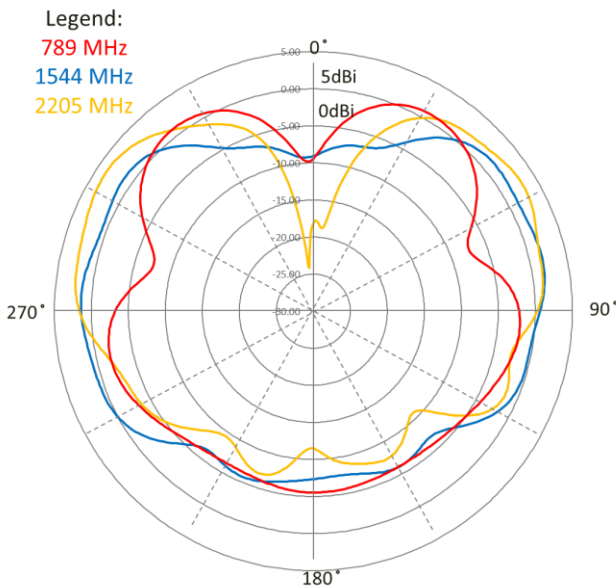

Elevation 2

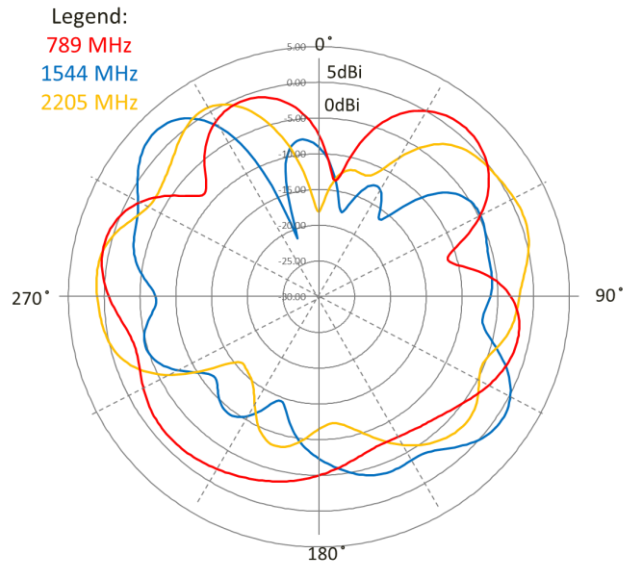

Data measured in free space with hinge at 90 degree bend

RADIATION PATTERN

Test setup

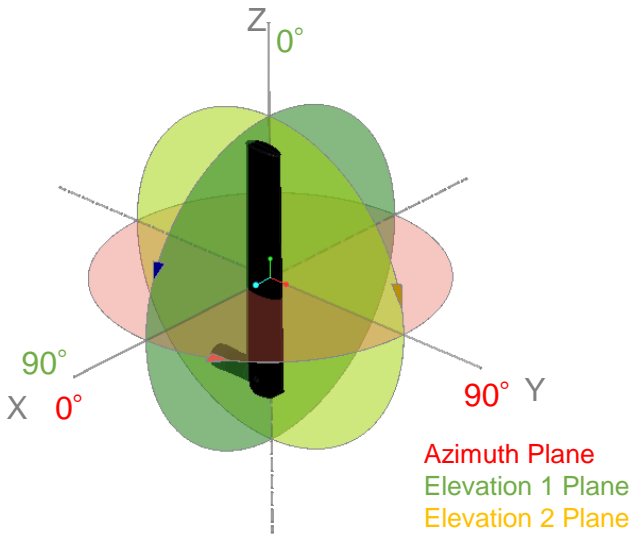

Azimuth

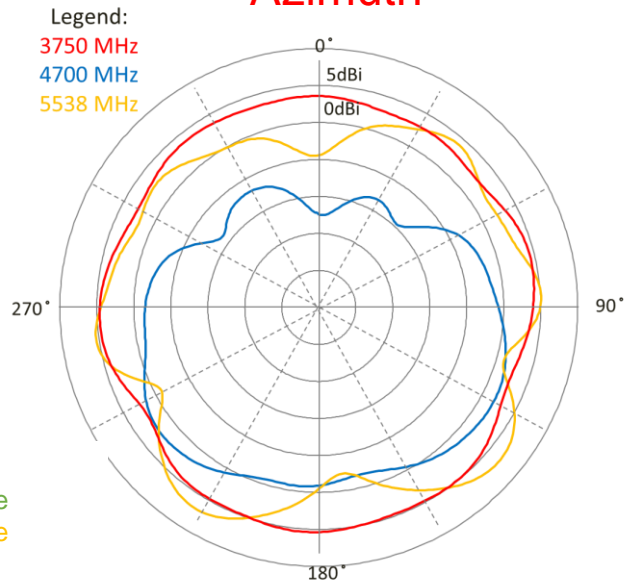

Elevation 1

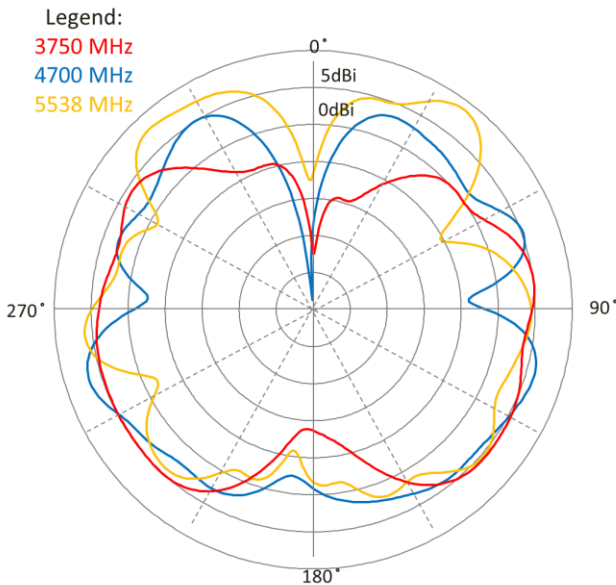

Elevation 2

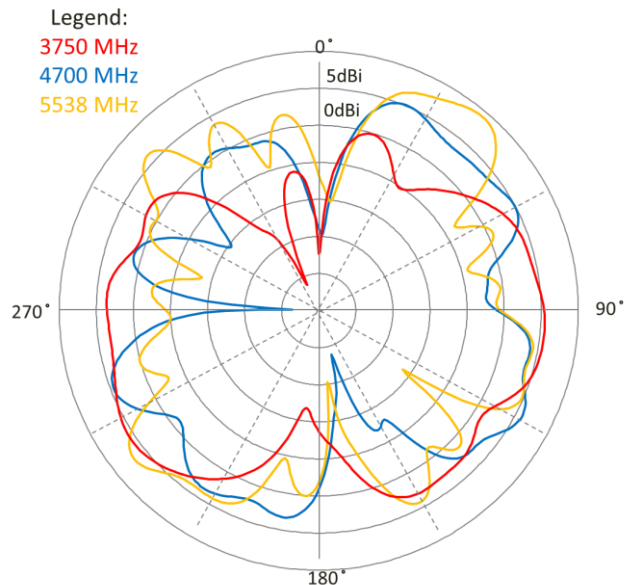



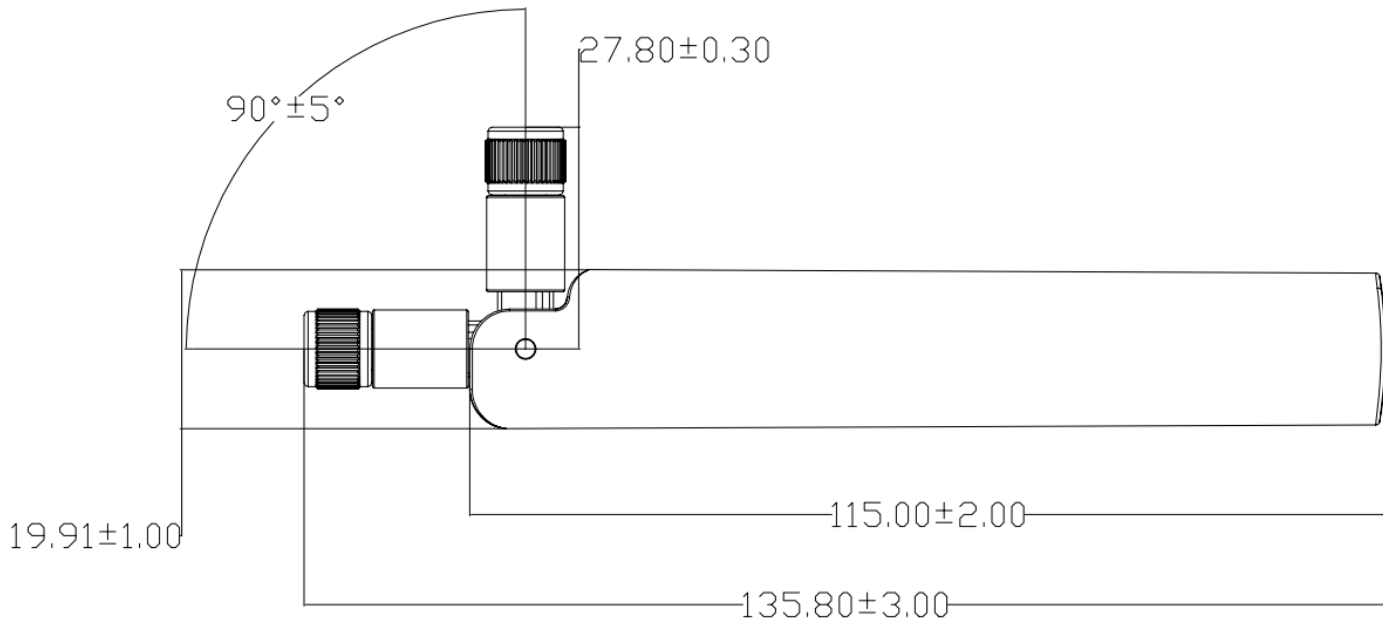

Data measured in free space with hinge at 90 degree bend

DIMENSIONS



MATING COMPONENTS

2195889-2	WHITE	SMA (Male)	5-1814400-2: SMA JACK, RIGHT ANGLE 	2016682-2: SMA GEN1 (MHF type), 1.13 cable, Length=100mm 2016682-4: SMA GEN1 (MHF type), 1.13 cable, Length=200mm 
2195889-1	BLACK	SMA (Male)	5-1814832-2: SMA JACK, VERTICAL 	2016694-2: SMA GEN4 (MHF4 type), 1.13 cable, Length=100mm 2016694-4: SMA GEN4 (MHF4 type), 1.13 cable, Length=200mm 
PART NUMBER	COLOR	CONNECT OR TYPE	RF CONNECTOR	SMA JACK TO MICRO COAX CABLE ASSEMBLIES
MATING COMPONENTS				

PACKAGING

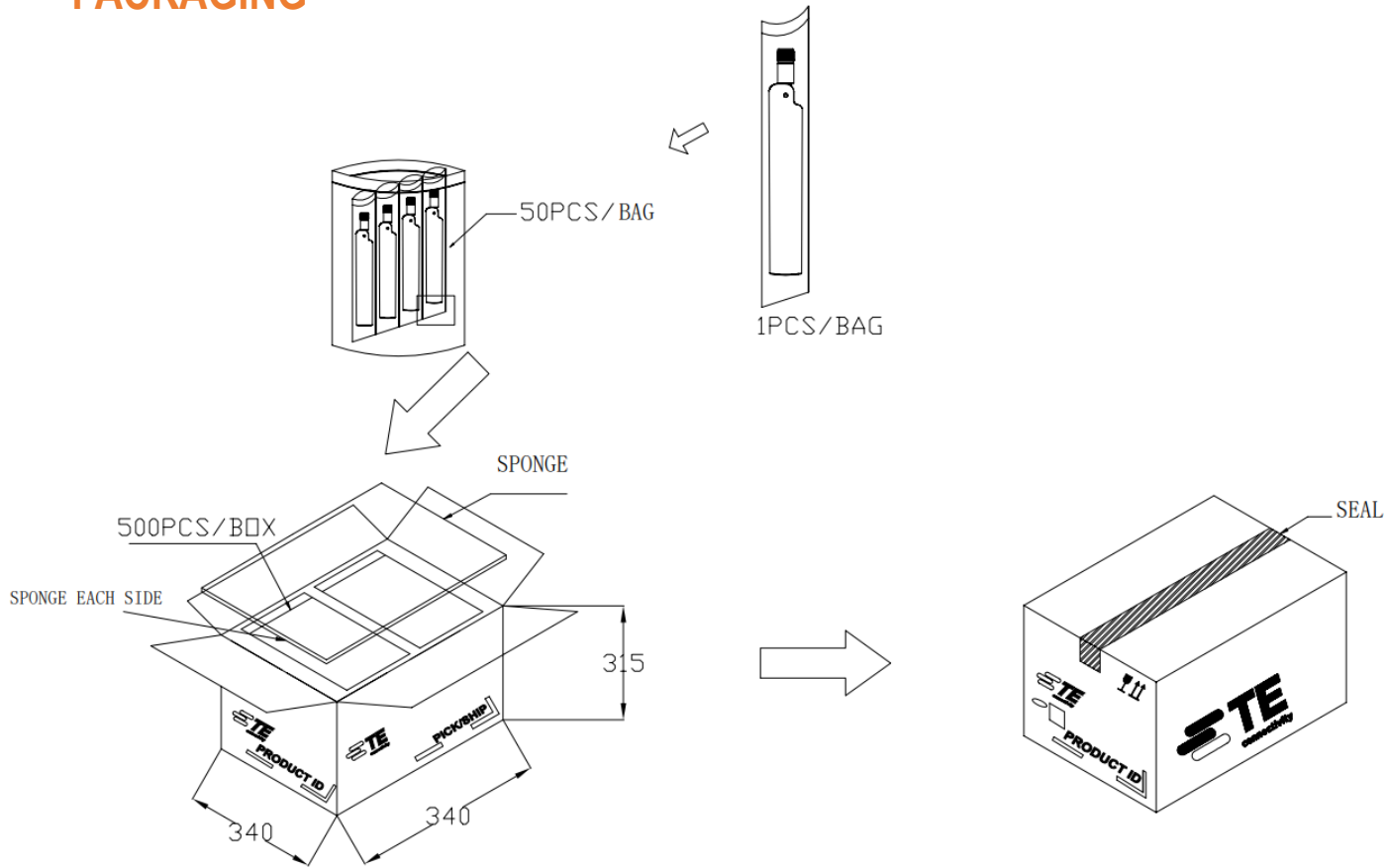

TE TECHNICAL SUPPORT CENTER

- USA: +1 (800) 522-6752
- Canada: +1 (905) 475-6222
- Mexico: +52 (0) 55-1106-0800
- Latin/S. America: +54 (0) 11-4733-2200
- Germany: +49 (0) 6251-133-1999
- UK: +44 (0) 800-267666
- France: +33 (0) 1-3420-8686
- Netherlands: +31 (0) 73-6246-999
- China: +86 (0) 400-820-6015

For phone numbers in other countries, go to te.com/support-center

te.com

TE Connectivity, TE Connectivity (logo) are trademarks. All other logos, products and/or company names referred to herein might be trademarks of their respective owners.

The information given herein, including drawings, illustrations and schematics which are intended for illustration purposes only, is believed to be reliable. However, TE Connectivity makes no warranties as to its accuracy or completeness and disclaims any liability in connection with its use. TE Connectivity's obligations shall only be as set forth in TE Connectivity's Standard Terms and Conditions of Sale for this product and in no case will TE Connectivity be liable for any incidental, indirect or consequential damages arising out of the sale, resale, use or misuse of the product. Users of TE Connectivity products should make their own evaluation to determine the suitability of each such product for the specific application.

© 2020 TE Connectivity Ltd. family of companies All Rights Reserved.

04/2021

单击下面可查看定价，库存，交付和生命周期等信息

[>>TE Connectivity\(泰科\)](#)