

THIS DRAWING IS UNPUBLISHED. RELEASED FOR PUBLICATION 20  
 © COPYRIGHT 20 BY - ALL RIGHTS RESERVED.

| REVISIONS |     |                          |           |     |      |
|-----------|-----|--------------------------|-----------|-----|------|
| P         | LTR | DESCRIPTION              | DATE      | DWN | APVD |
|           | A   | INITIAL RELEASE          | 07MAR2018 | RS  | SZ   |
|           | A1  | REVISE PER ECR-18-008492 | 06JUN2018 | RS  | SZ   |
|           |     |                          |           |     |      |

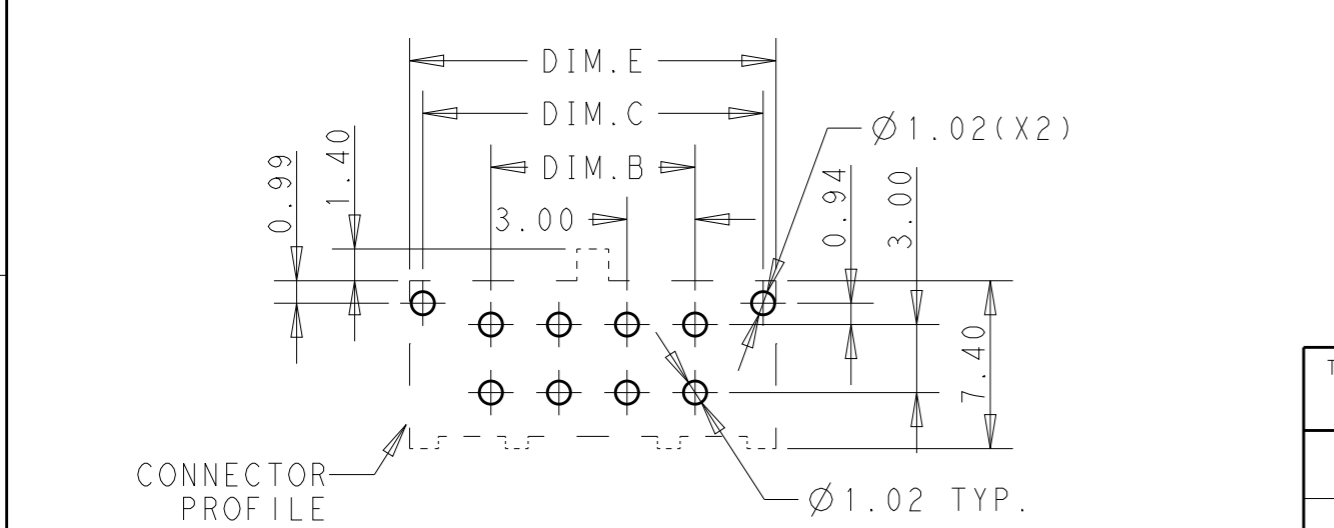
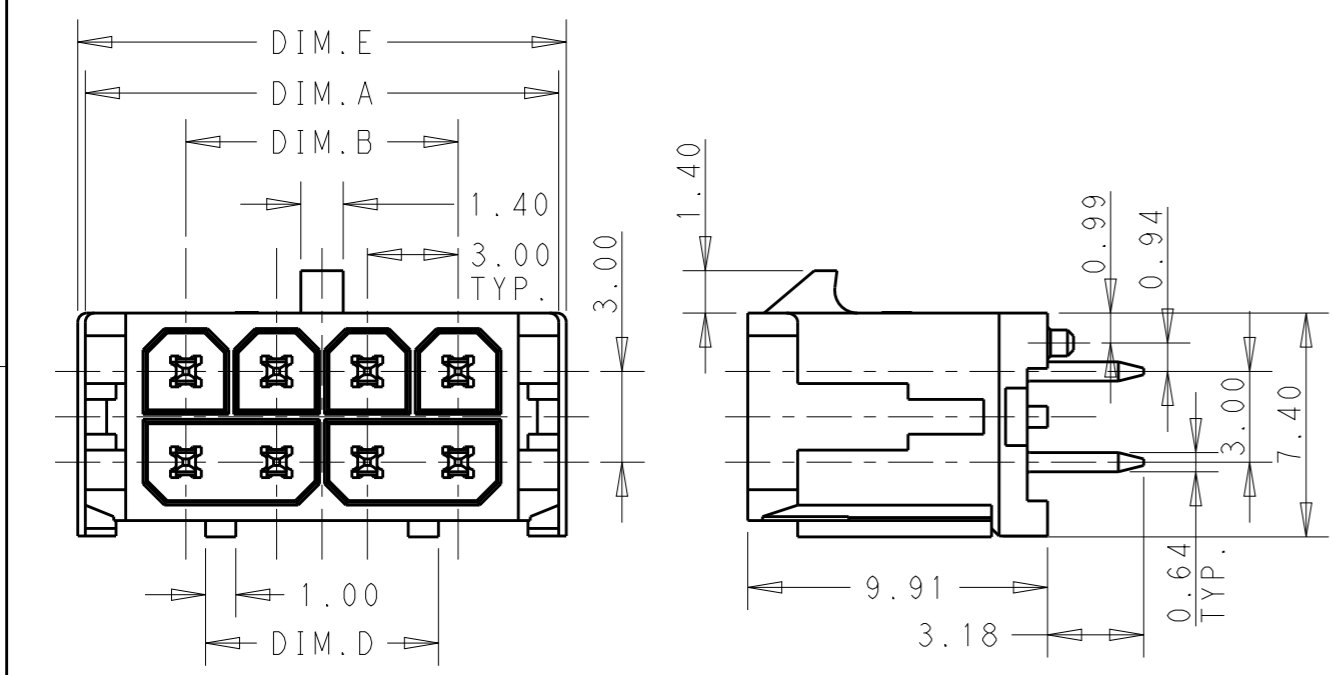
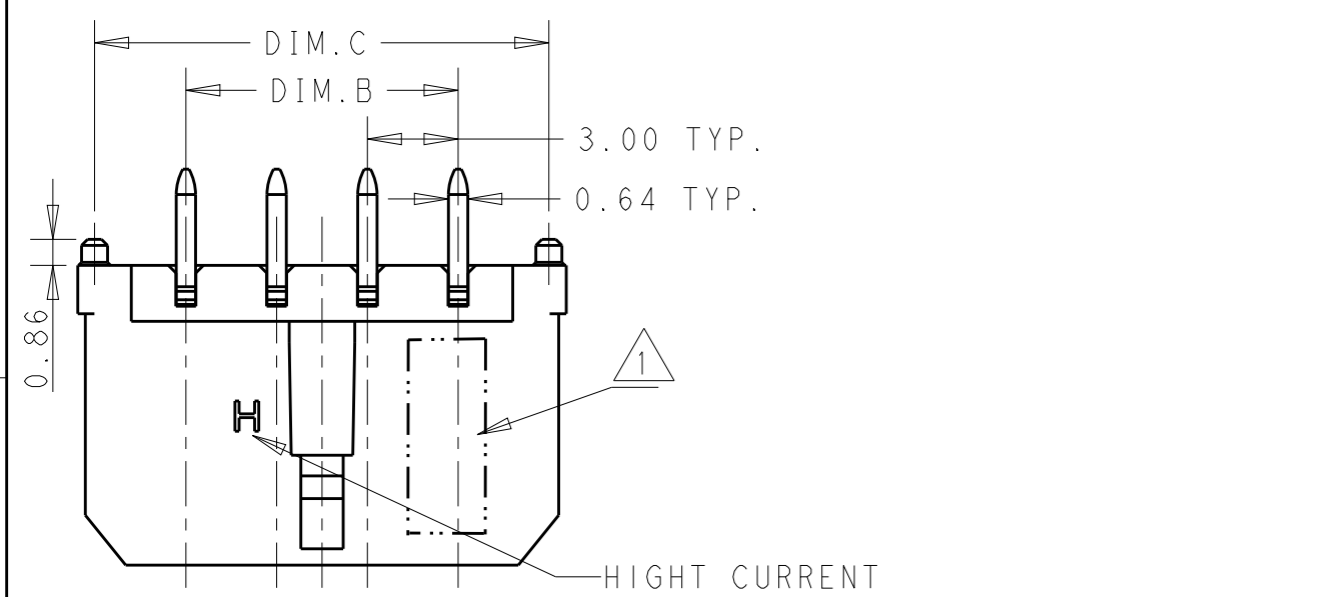

RECOMMENDED PCB LAYOUT (COMPONENT SIDE)  
 PCB THICKNESS=1.57MM  
 DEFAULT TOLERANCE: ±0.05

NOTES:  
 1. PART NUMBER AND DATE CODE.  
 2. MATERIAL:  
 HOUSING: THERMO PLASTIC, COLOR:BLACK.  
 TERMINAL: COPPER ALLOY.  
 3. PLATING: SEE REMARK IN PART NUMBER LIST.

| REMARK | DIM.E | DIM.D | DIM.C | DIM.B | DIM.A | CIRCUIT | PART NUMBER |
|--------|-------|-------|-------|-------|-------|---------|-------------|
|        | 40.15 | 31.70 | 39.00 | 33.00 | 39.65 | 24      | *-2204801-9 |
|        | 37.15 | 28.70 | 36.00 | 30.00 | 36.65 | 22      | *-2204801-0 |
|        | 34.15 | 25.70 | 33.00 | 27.00 | 33.65 | 20      | 9-2204801-* |
|        | 31.15 | 22.70 | 30.00 | 24.00 | 30.65 | 18      | 8-2204801-* |
|        | 28.15 | 19.70 | 27.00 | 21.00 | 27.65 | 16      | 7-2204801-* |
|        | 25.15 | 16.70 | 24.00 | 18.00 | 24.65 | 14      | 6-2204801-* |
|        | 22.15 | 13.70 | 21.00 | 15.00 | 21.65 | 12      | 5-2204801-* |
|        | 19.15 | 10.70 | 18.00 | 12.00 | 18.65 | 10      | 4-2204801-* |
|        | 16.15 | 7.70  | 15.00 | 9.00  | 15.65 | 8       | 3-2204801-* |
|        | 13.15 | 2.95  | 12.00 | 6.00  | 12.65 | 6       | 2-2204801-* |
|        | 10.15 | 2.95  | 9.00  | 3.00  | 9.65  | 4       | 1-2204801-* |
|        | 7.15  | 2.95  | 6.00  | N/A   | 6.65  | 2       | 2204801-*   |

\*: PLATING ON CONTACT AREA  
 1: GOLD FLASH  
 2: 5u" GOLD PLATING  
 3: 10u" GOLD PLATING  
 4: 15u" GOLD PLATING  
 5: 30u" GOLD PLATING  
 7: 100u" BRIGHT TIN PLATING  
 8: 100u" MATTE TIN PLATING

|   |  |                              |   |                         |
|---|--|------------------------------|---|-------------------------|
| THIS DRAWING IS A CONTROLLED DOCUMENT.                                      |  | DWN 06-JUN-17<br>Radar Sun   | TE Connectivity   |                         |
| DIMENSIONS: mm  |  | CHK 06-JUN-17<br>Sunny Zhao  |   |                         |
| TOLERANCES UNLESS OTHERWISE SPECIFIED:                                      |  | APVD 06-JUN-17<br>Sunny Zhao | NAME<br>ELCON MICRO POWER CONNECTOR, HEADER, VERTICAL DIP, 3.00MM PITCH, 2XN CIRCUITS |                         |
| 0 PLC ±-<br>1 PLC ±0.30<br>2 PLC ±0.20<br>3 PLC ±-<br>4 PLC ±-<br>ANGLES ±- |  | PRODUCT SPEC<br>108-128068   | SIZE<br>A3  |                         |
| MATERIAL  |  | APPLICATION SPEC<br>-        | CAGE CODE<br>00779  | DRAWING NO<br>C-2204801 |
| FINISH  |  | WEIGHT<br>-                  | RESTRICTED TO<br>-  |                         |
| CUSTOMER DRAWING  |  |                              | SCALE<br>4:1  | SHEET<br>1 OF 2         |
|   |  |                              | REV<br>A1   |                         |

THIS DRAWING IS UNPUBLISHED. RELEASED FOR PUBLICATION 20  
© COPYRIGHT 20 BY - ALL RIGHTS RESERVED.

| REVISIONS |     |             |      |     |      |
|-----------|-----|-------------|------|-----|------|
| P         | LTR | DESCRIPTION | DATE | DWN | APVD |
| -         | -   | SEE SHEET 1 | -    | -   | -    |
|           |     |             |      |     |      |
|           |     |             |      |     |      |

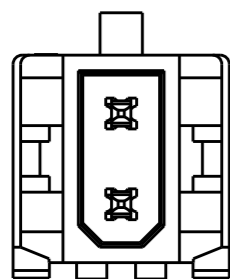

CIRCUIT SIZE:2

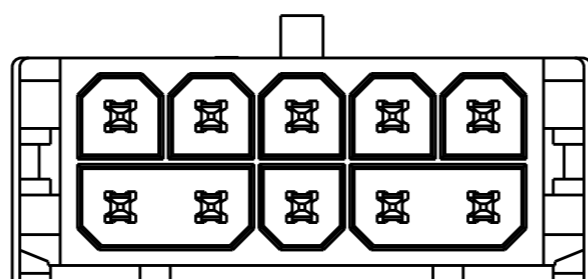

CIRCUIT SIZE:10

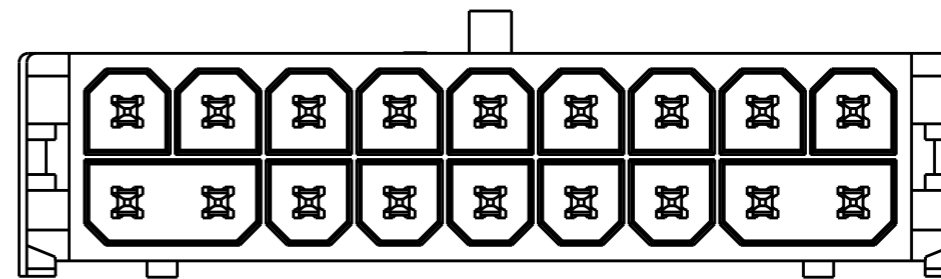

CIRCUIT SIZE:18

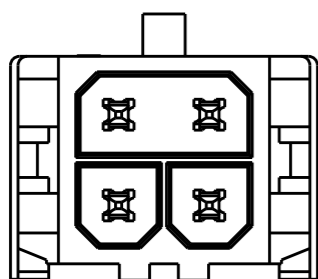

CIRCUIT SIZE:4

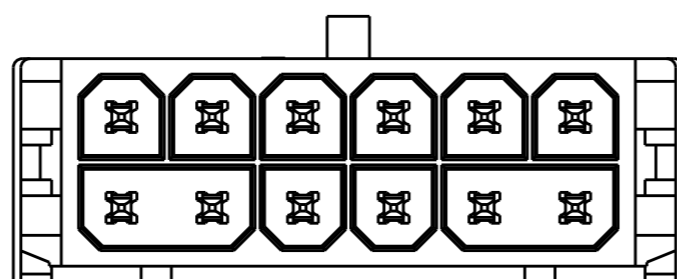

CIRCUIT SIZE:12

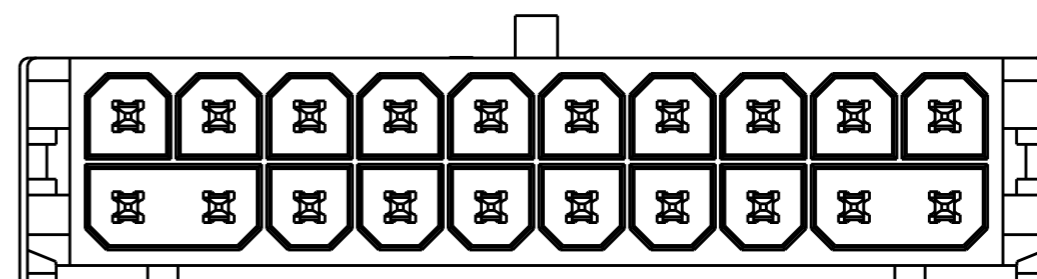

CIRCUIT SIZE:20

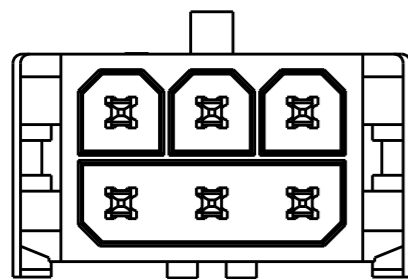

CIRCUIT SIZE:6

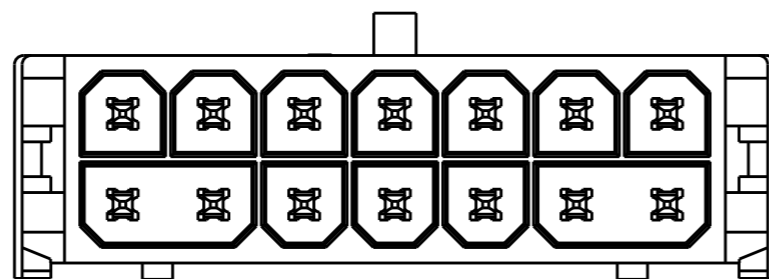

CIRCUIT SIZE:14

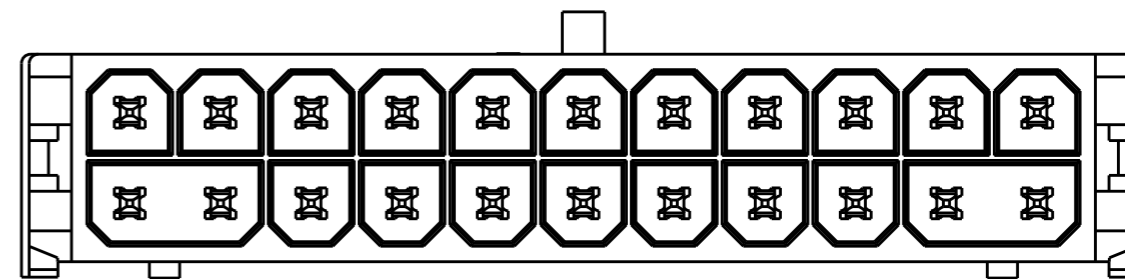

CIRCUIT SIZE:22

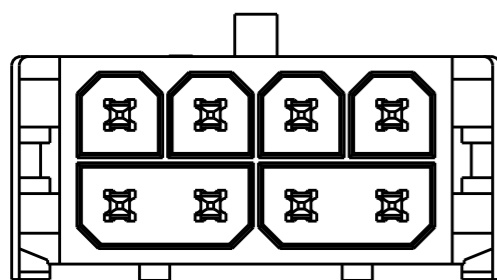

CIRCUIT SIZE:8

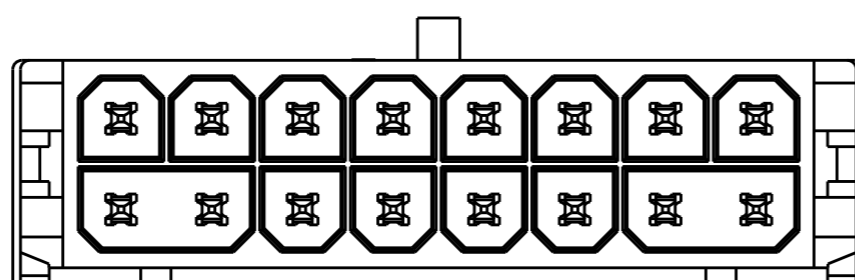

CIRCUIT SIZE:16

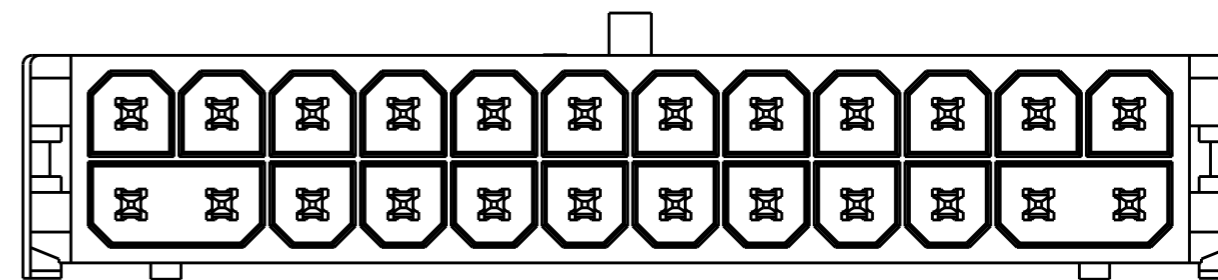

CIRCUIT SIZE:24

THIS DRAWING IS A CONTROLLED DOCUMENT.

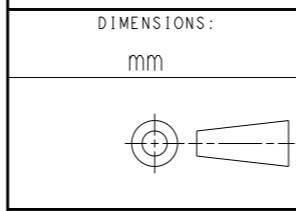

MATERIAL

| DIMENSIONS: |    | TOLERANCES UNLESS OTHERWISE SPECIFIED: |  |
|-------------|----|--|--|
|             | mm |  |  |
| 0 PLC       |    | ±                                      |  |
| 1 PLC       |    | ±0.30                                  |  |
| 2 PLC       |    | ±0.20                                  |  |
| 3 PLC       |    | ±                                      |  |
| 4 PLC       |    | ±                                      |  |
| ANGLES      |    | ±                                      |  |
| FINISH      |    |  |  |

|                  |            |
|------------------|------------|
| DWN              | 06-JUN-17  |
| Radar Sun        |            |
| CHK              | 06-JUN-17  |
| Suny Zhao        |            |
| APVD             | 06-JUN-17  |
| Suny Zhao        |            |
| PRODUCT SPEC     | 108-128068 |
| APPLICATION SPEC | -          |
| WEIGHT           | -          |
| CUSTOMER DRAWING |            |

**STE** TE Connectivity

NAME  
ELCON MICRO POWER CONNECTOR,  
HEADER, VERTICAL DIP,  
3.00MM PITCH, 2XN CIRCUITS

|      |           |            |               |
|------|-----------|------------|---------------|
| SIZE | CAGE CODE | DRAWING NO | RESTRICTED TO |
| A3   | 00779     | C-2204801  | -             |

SCALE 4:1 SHEET 2 OF 2 REV A1

单击下面可查看定价，库存，交付和生命周期等信息

[>>TE Connectivity\(泰科\)](#)