

THIS DRAWING IS UNPUBLISHED. RELEASED FOR PUBLICATION 20
 © COPYRIGHT 20 BY - ALL RIGHTS RESERVED.

REVISIONS

P	LTR	DESCRIPTION	DATE	DWN	APVD
	A	RELEASED	25MAY2018	K.T	E.I
	B	REVISED	12JUN2018	K.T	E.I
	B1	REVISED	31JULY2018	K.T	E.I
	B2	REVISED	9JAN2019	H.O	E.I

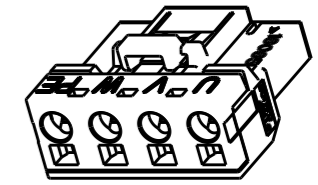
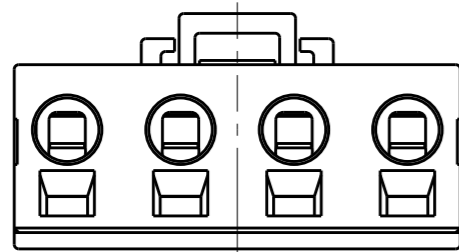

SCALE 1:1

1-2331743-4 (KEY: X)

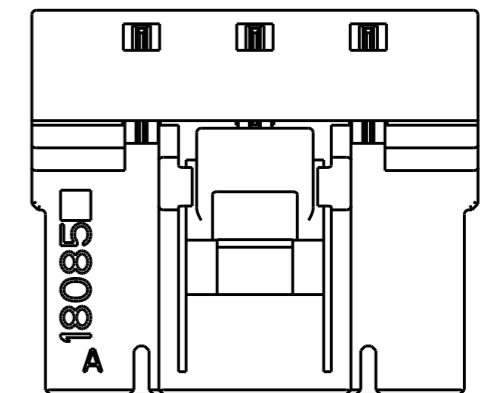
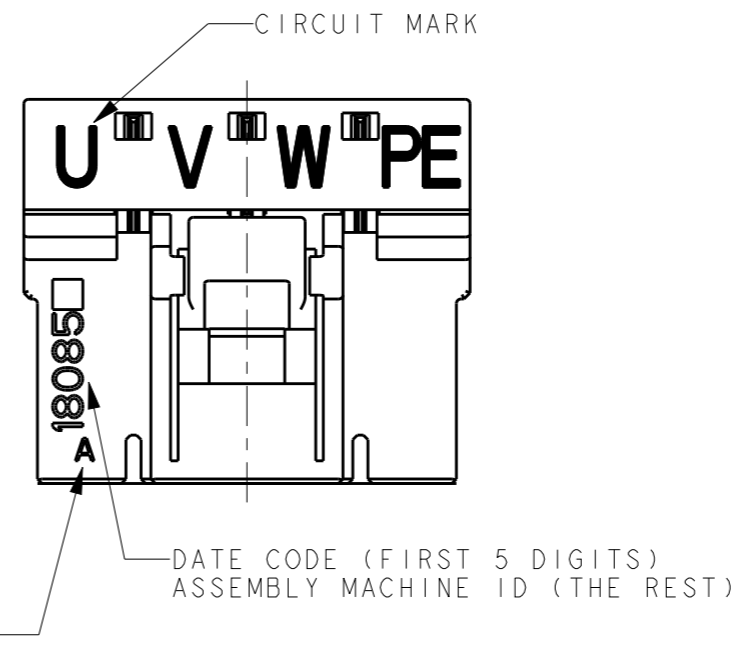
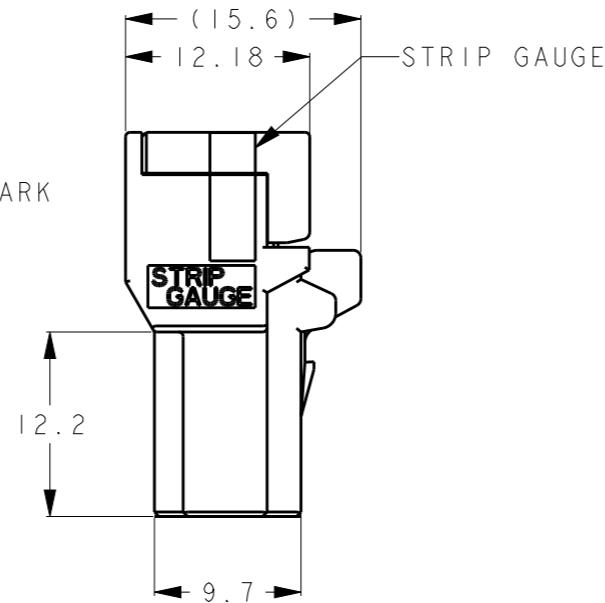
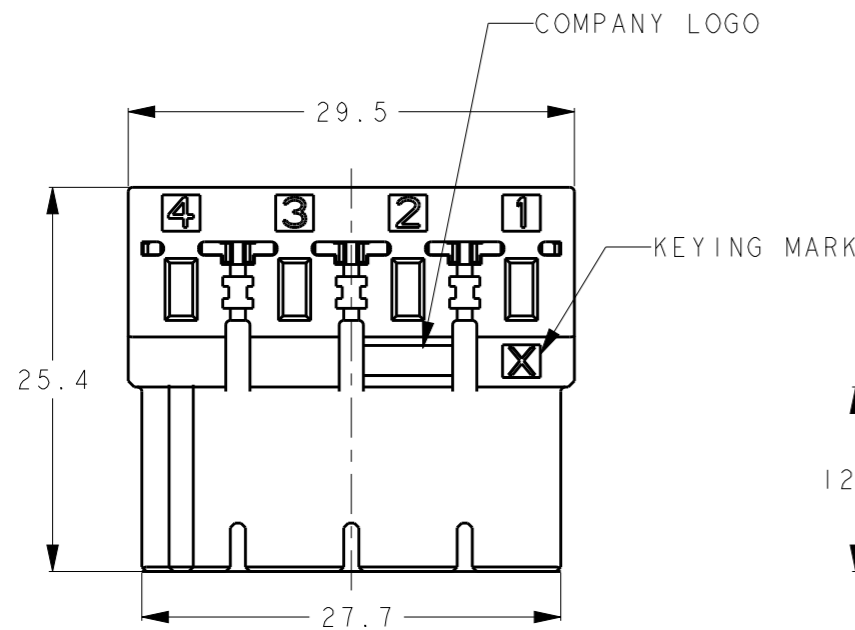

1-2331743-1
 (KEY: X, W/O CIRCUIT MARK)

- 1 MATERIAL
 HOUSING: THERMOPLASTIC POLYESTER
 CONTACT: COPPER ALLOY
 SPRING: STAINLESS STEEL
- 2 PLATING
 CONTACT POINT: UNDER Ni PLATING.
 OVER Au PLATING.
 CABLE CLAMPING POINT: UNDER Ni PLATING.
 OVER Tin PLATING

W/O	X	4	1-2331743-1
W/O	Y	4	2-2331743-1
WITH	X	4	1-2331743-4
CIRCUIT MARK	KEYING	POSN	PART NUMBER

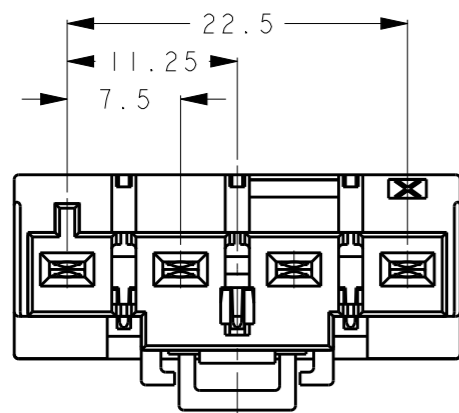

1-2331743-4 (KEY: X)

THIS DRAWING IS A CONTROLLED DOCUMENT.		DWN K. TERAJIMA 25MAY2018		
DIMENSIONS: mm		CHK T. SHIMOYASU 25MAY2018		
TOLERANCES UNLESS OTHERWISE SPECIFIED: ±0.3		APVD E. IKEMATSU 25MAY2018	NAME RECEPTACLE ASSEMBLY, 4POS DYNAMIC 3950	
0 PLC ± 1 PLC ± 2 PLC ± 3 PLC ± 4 PLC ± ANGLES ±3°		PRODUCT SPEC 108-78997	SIZE A3	
MATERIAL SEE NOTE		APPLICATION SPEC 411-78272	CAGE CODE 00779	DRAWING NO 2331743
FINISH -		WEIGHT -	RESTRICTED TO -	
-		CUSTOMER DRAWING	SCALE 2:1	SHEET 1 OF 2
				REV B2

4

3

2

1

THIS DRAWING IS UNPUBLISHED. RELEASED FOR PUBLICATION 20
© COPYRIGHT 20 BY - ALL RIGHTS RESERVED.

REVISIONS					
P	LTR	DESCRIPTION	DATE	DWN	APVD
	-	SEE SHEET 1	-	-	-

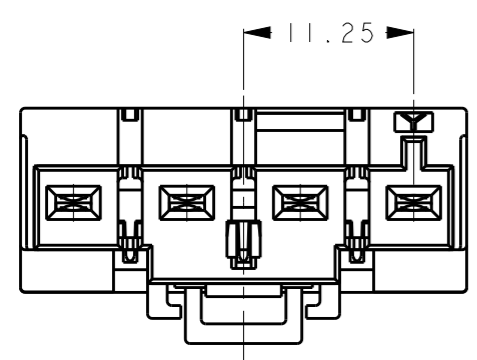
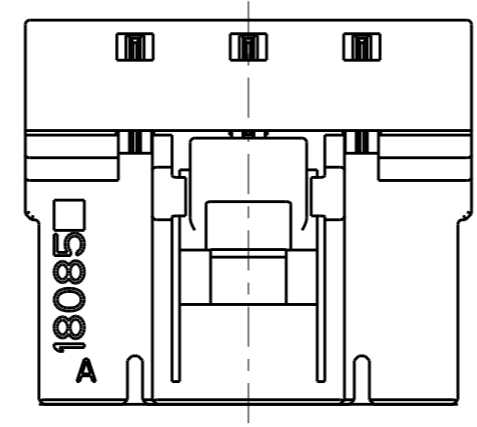
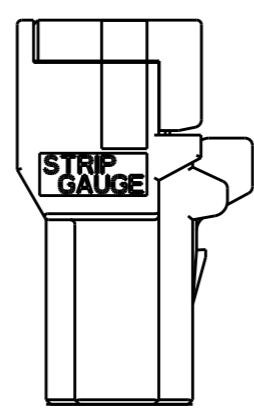
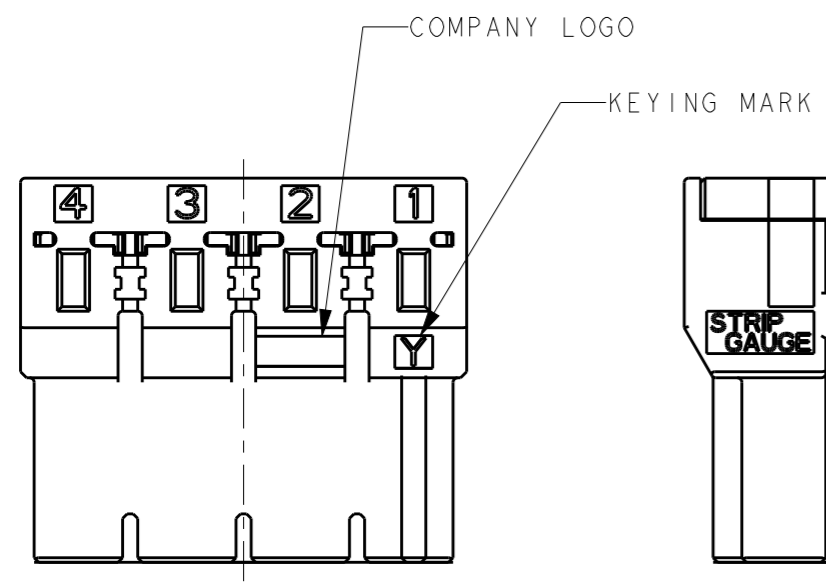
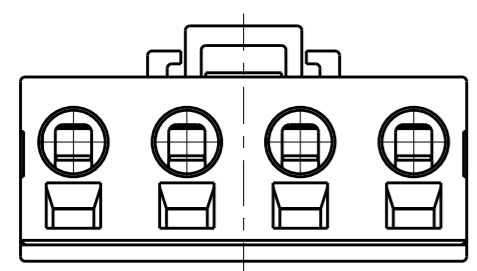

2-2331743-1
(KEY:Y, W/O CIRCUIT MARK)

THIS DRAWING IS A CONTROLLED DOCUMENT.		DWN K. TERAJIMA 25MAY2018			
DIMENSIONS: mm		CHK T. SHIMOYASU 25MAY2018			
		APVD E. IKEMATSU 25MAY2018			
TOLERANCES UNLESS OTHERWISE SPECIFIED: ± 0.3		PRODUCT SPEC 108-78997	NAME RECEPTACLE ASSEMBLY, 4POS DYNAMIC 3950		
0 PLC ± 1 PLC ± 2 PLC ± 3 PLC ± 4 PLC ± ANGLES ±3°		APPLICATION SPEC 411-78272	SIZE A3	CAGE CODE 00779	DRAWING NO C-2331743
MATERIAL SEE NOTE		WEIGHT -	RESTRICTED TO -		
FINISH -		CUSTOMER DRAWING	SCALE 2:1	SHEET 2 OF 2	REV B2

单击下面可查看定价，库存，交付和生命周期等信息

[>>TE Connectivity\(泰科\)](#)