

THIS DRAWING IS UNPUBLISHED.

RELEASED FOR PUBLICATION

20

© COPYRIGHT 20 BY -

ALL RIGHTS RESERVED.

REVISIONS

P	LTR	DESCRIPTION	DATE	DWN	APVD
	A	INITIAL RELEASE	16APR2015	DL	CW
	B	ECR-21-111798	06OCT2021	WQR	CW
	BI	ECR-22-127614	27JAN2022	WQR	CW

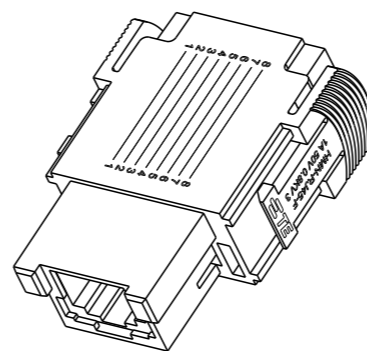
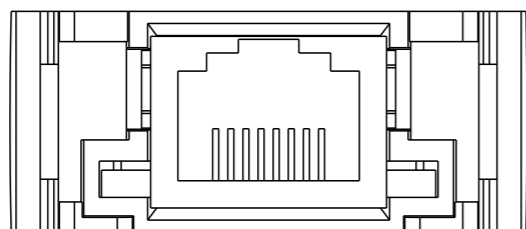

SCALE 1:1

NOTES:

- TECHNICAL CHARACTERISTICS:
 INSULATION MATERIAL: PC
 RATED VOLTAGE: 50V
 RATED CURRENT: 1A
 INSULATION RESISTANCE: $\geq 400M\Omega$
 RATED IMPULSE VOLTAGE: 0.8KV
 POLLUTION DEGREE: 3
 FLAMMABILITY: UL94V-0
 MATING CYCLES: 750
 OPERATION TEMPERATURE: $-40^{\circ}C \sim +70^{\circ}C$

注释:

- 技术参数:
 绝缘材料: PC
 额定电压: 50V
 额定电流: 1A
 绝缘电阻: $\geq 400M\Omega$
 脉冲电压: 0.8KV
 污染等级: 3
 阻燃等级: UL94V-0
 插拔次数: 750
 工作温度: $-40^{\circ}C \sim +70^{\circ}C$

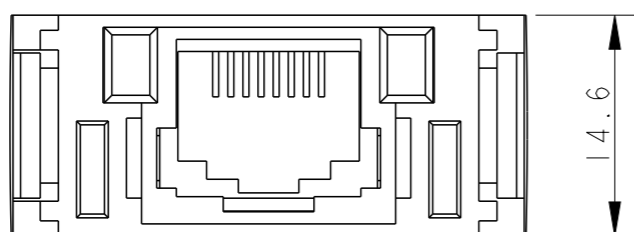
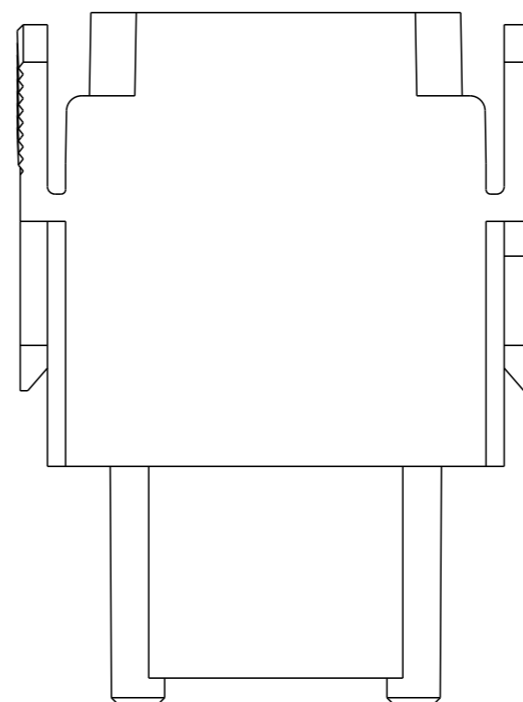
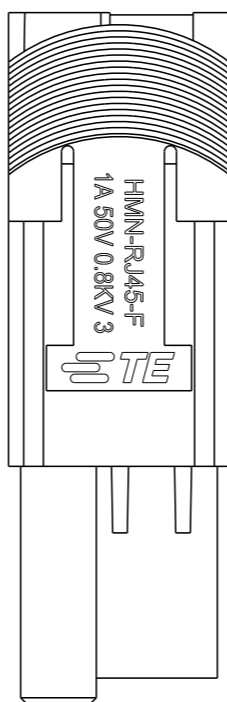
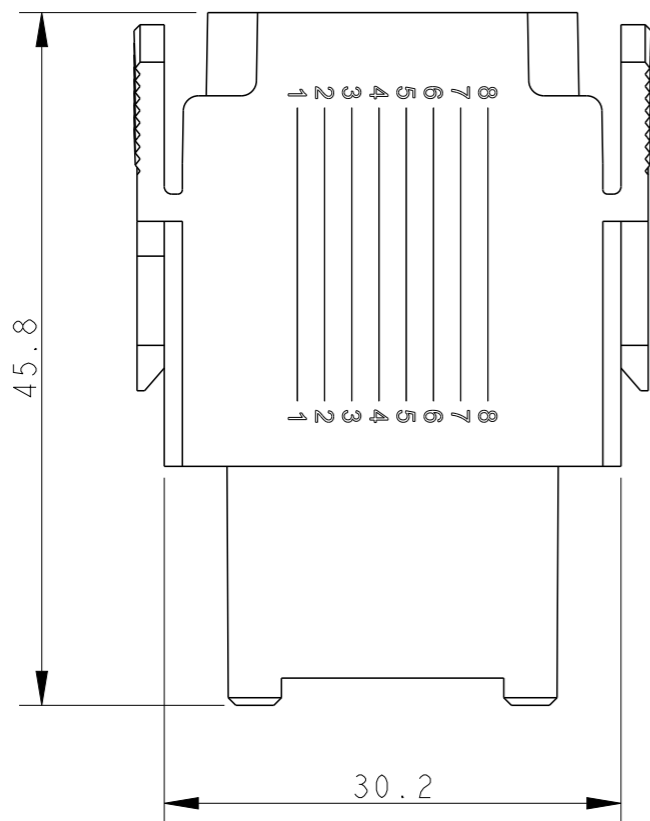
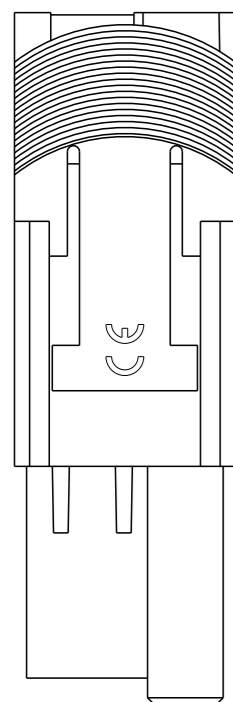

14.6

HMN-RJ45-F	T2113000201-000
DESCRIPTION	PART NUMBER

THIS DRAWING IS A CONTROLLED DOCUMENT.		DWN	DAVID LI	16APR2015		
		CHK	CHRIS WANG	16APR2015		
		APVD	XU XIANG	16APR2015		
		PRODUCT SPEC	108-137065			
		APPLICATION SPEC	114-137065		NAME	HMN-RJ45-F
DIMENSIONS: mm		TOLERANCES UNLESS OTHERWISE SPECIFIED:		SIZE		A3
		0 PLC	±-	CAGE CODE		-
		1 PLC	±-	DRAWING NO		©-T2113000201000
		2 PLC	±-	RESTRICTED TO		
		3 PLC	±-	SCALE		2:1
		4 PLC	±-	SHEET		1 OF 1
		ANGLES	±-	REV		BI
MATERIAL		FINISH		CUSTOMER DRAWING		
				WEIGHT		-

单击下面可查看定价，库存，交付和生命周期等信息

[>>TE Connectivity\(泰科\)](#)