

printed on 3 Feb 2021 16:39 (China Standard Time) from TE304429

LOC	DIST	REVISIONS					
		P	LTR	DESCRIPTION	DATE	DWN	APVD
-	-		CI	REVISED	14JUL2010	HMR	TM
			D	REVISED	17DEC2012	H.M	N.Y
			DI	REVISED	03FEB2021	F.Z	R.B

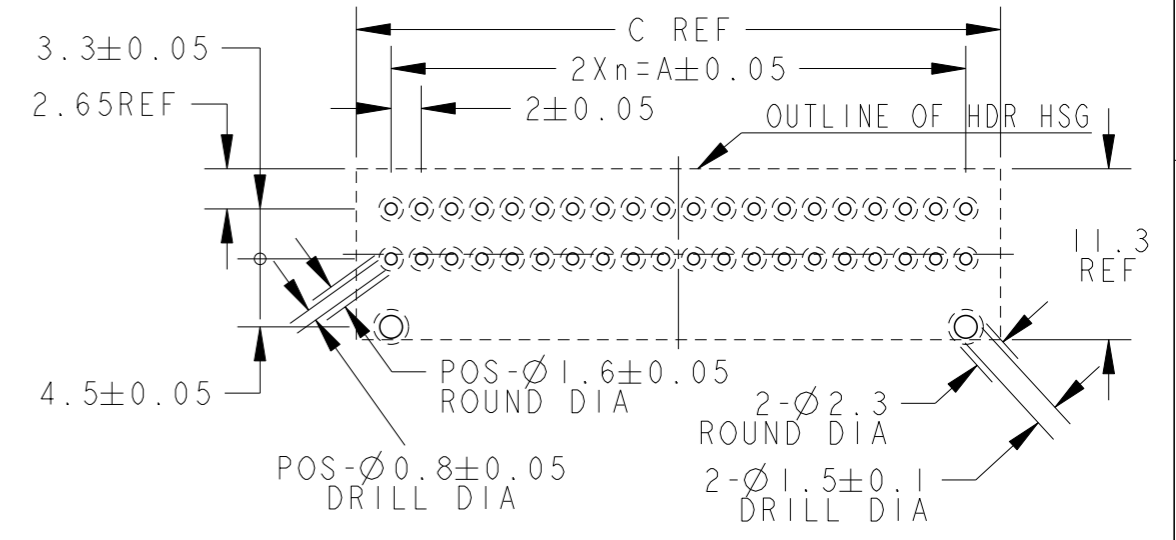

RECOMMEND PC BOARD HOLE PATTERN : CONNECTOR MOUNT SIDE (NOT ACCUMULATE TOLERANCE)
 PC BOARD THICKNESS : 1.0~1.6±0.1

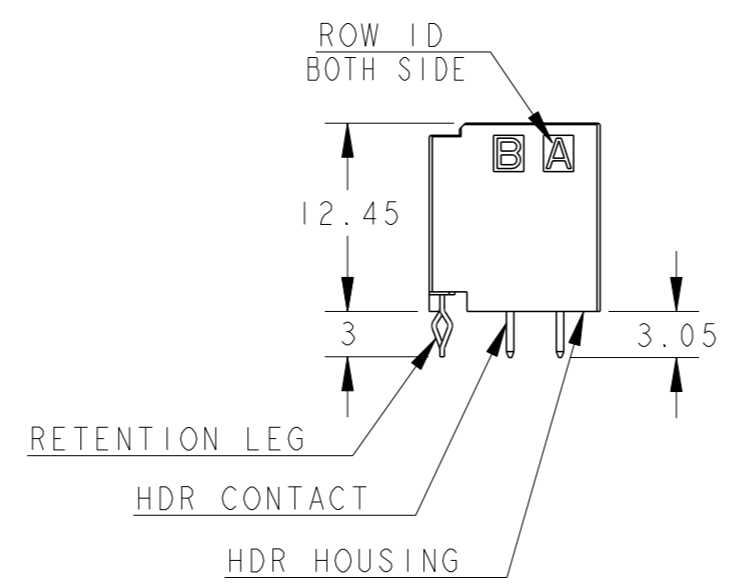
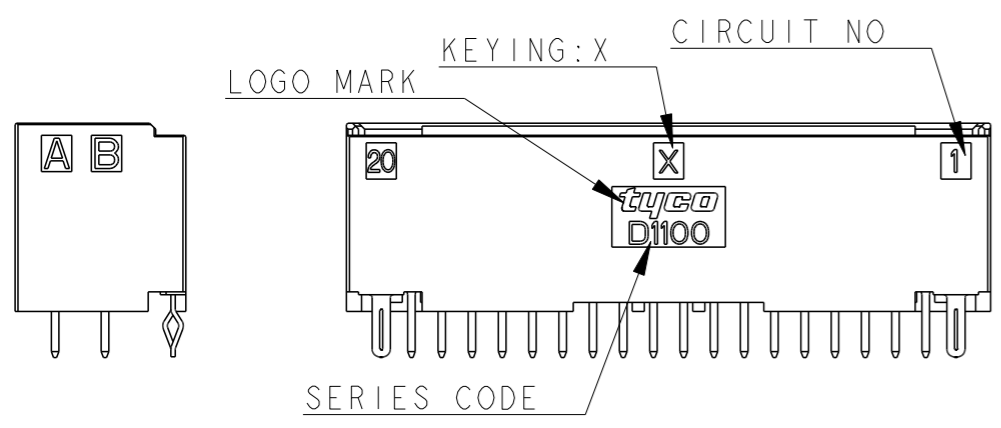
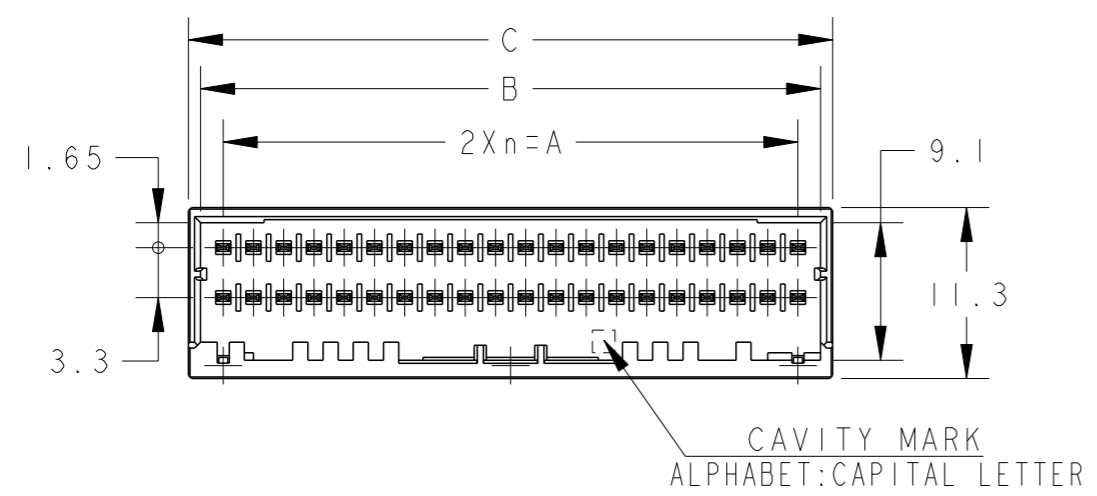
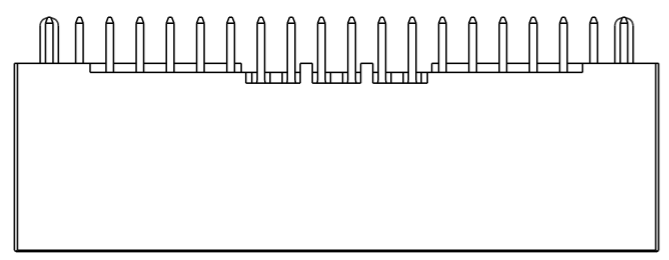
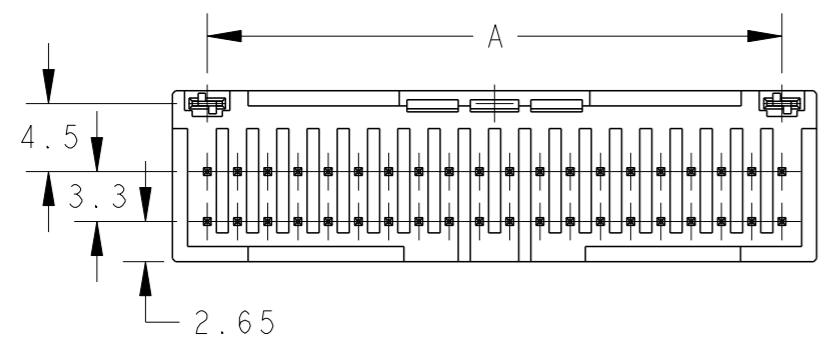

40POS(X-KEY): 1-1871315-0

1. MATERIAL: HOUSING: GLASS FILLED THERMO PLASTIC POLYESTER(94V-0)
 COLOR: BLACK
 CONTACT: PRE-TIN COPPER ALLOY
 RETENTION LEG: PRE-TIN COPPER ALLOY
 2. THE SHAPE, SIZE AND POSITION OF THE CHARACTER SHOW THE OUTLINE. THEY DON'T SHOW DETAILS.

40	X	19	38.0	41.0	42.6	PRE-TIN	1-1871315-0
34	Y	16	32.0	35.0	36.6	PRE-TIN	2-1871315-7
34	X	16	32.0	35.0	36.6	PRE-TIN	1-1871315-7
32	X	15	30.0	33.0	34.6	PRE-TIN	1-1871315-6
30	X	14	28.0	31.0	32.6	PRE-TIN	1-1871315-5
28	X	13	26.0	29.0	30.6	PRE-TIN	1-1871315-4
26	X	12	24.0	27.0	28.6	PRE-TIN	1-1871315-3
24	X	11	22.0	25.0	26.6	PRE-TIN	1-1871315-2
22	X	10	20.0	23.0	24.6	PRE-TIN	1-1871315-1
POS	KEY	n	A	B	C	FINISH	PART NO

THIS DRAWING IS A CONTROLLED DOCUMENT.		DWN	T. KUDO	23AUG2005	TE Connectivity
DIMENSIONS: mm		CHK	D. MITSUGI	23AUG2005	
TOLERANCES UNLESS OTHERWISE SPECIFIED: ±0.3, ±5°		APVD	D. MITSUGI	23AUG2005	NAME DYNAMIC D1100 SERIES HDR ASSY, V-TYPE, PRE-TIN 22~40POS
0-PLC ±		PRODUCT SPEC	-	108-78298	
1-PLC ±0.1		APPLICATION SPEC	-	108-137366	SIZE A3
2-PLC ±0.01		WEIGHT	-	-	
3-PLC ±0.001		114-5377			CAGE CODE 00779
4-PLC ±0.0001		CUSTOMER DRAWING			
ANGLES ±		SCALE 2:1			DRAWING NO C=1871315
FINISH -		SHEET 1 OF 3			
MATERIAL TBD		REV DI			RESTRICTED TO

4

3

2

1

THIS DRAWING IS UNPUBLISHED.

RELEASED FOR PUBLICATION

20

LOC J

DIST -

REVISIONS

© COPYRIGHT 2020 TE Connectivity. All Rights Reserved. ALL RIGHTS RESERVED.

P	LTR	DESCRIPTION	DATE	DWN	APVD
		SEE SHEET 1			

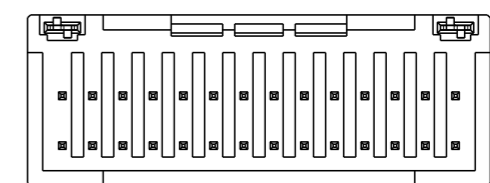
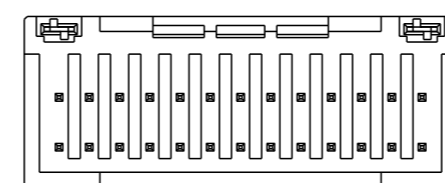
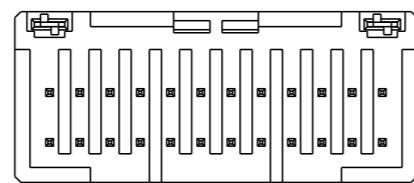
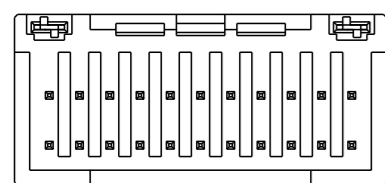
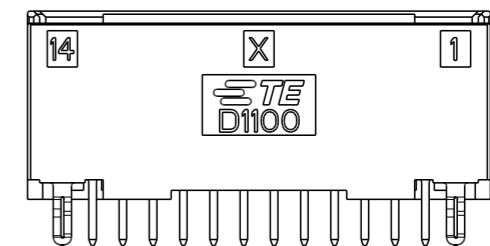
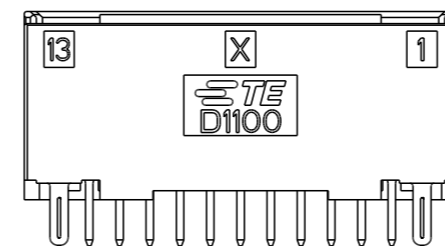
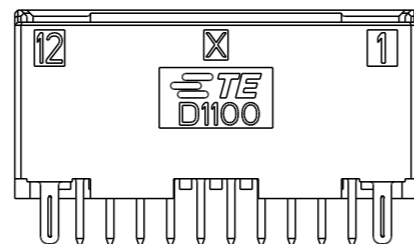
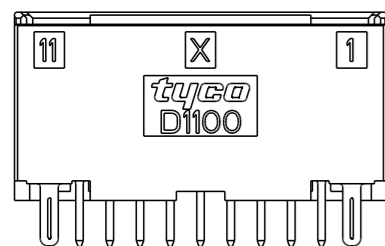
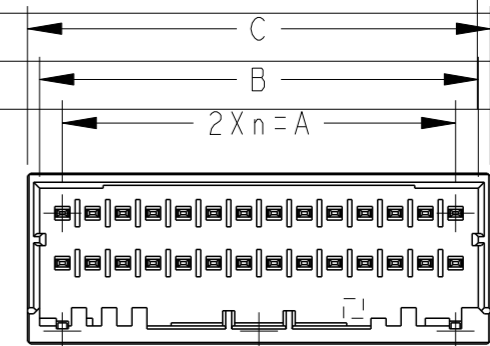
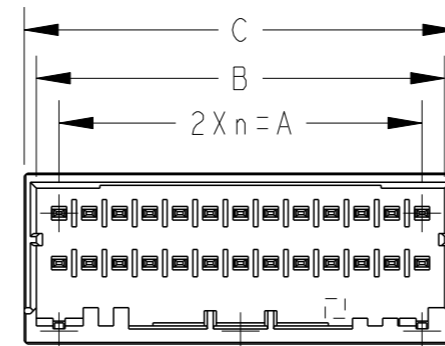
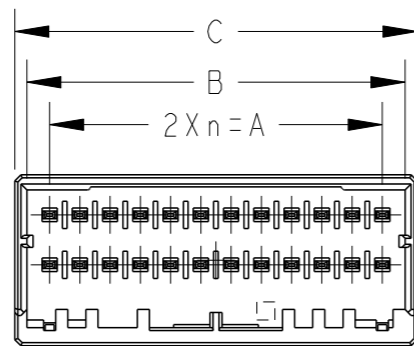
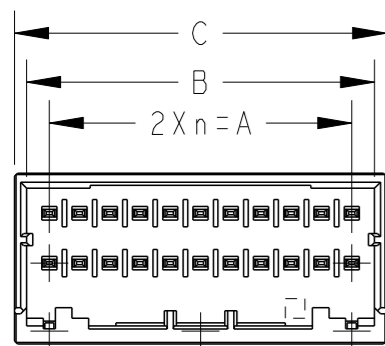

22POS(X-KEY)
1-1871315-1

24POS(X-KEY)
1-1871315-2

26POS(X-KEY)
1-1871315-3

28POS(X-KEY)
1-1871315-4

THIS DRAWING IS A CONTROLLED DOCUMENT.		DWN T. KUDO 03DEC2020	TE Connectivity	
DIMENSIONS: mm		CHK D. MITSUGI 23AUG2005		
TOLERANCES UNLESS OTHERWISE SPECIFIED:		APVD D. MITSUGI 23AUG2005	NAME DYNAMIC D1100 SERIES HDR ASSY, V-TYPE, PRE-TIN 22~40POS	
0 PLC ±-		PRODUCT SPEC 108-78298	SIZE A3	
1 PLC ±0.5		APPLICATION SPEC 108-137366	CAGE CODE 00779	DRAWING NO C=1871315
2 PLC ±0.13		114-5377	RESTRICTED TO -	
3 PLC ±0.013		WEIGHT -	SCALE 2:1	
4 PLC ±0.0001		CUSTOMER DRAWING	SHEET 2 OF 3	
ANGLES ±-			REV D1	
FINISH -				
MATERIAL TBD				

SEE SHEET 1 OF 2

Printed on 3 Feb 2021 16:39 (China Standard Time) from TE304429

4

3

2

1

THIS DRAWING IS UNPUBLISHED. RELEASED FOR PUBLICATION 20
© COPYRIGHT 2020 TE Connectivity. All Rights Reserved. ALL RIGHTS RESERVED.

LOC	DIST	REVISIONS					
		P	LTR	DESCRIPTION	DATE	DWN	APVD
-	-			SEE SHEET 1			

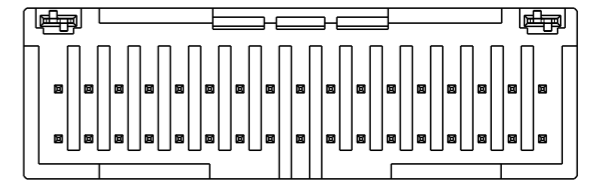
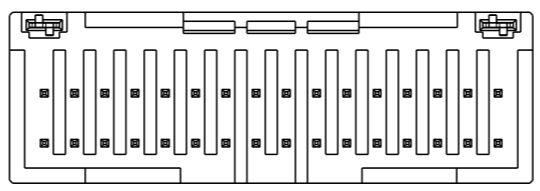
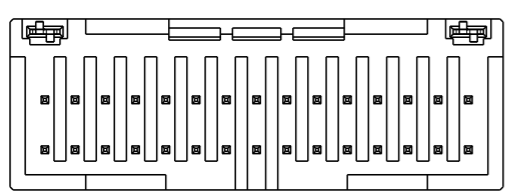
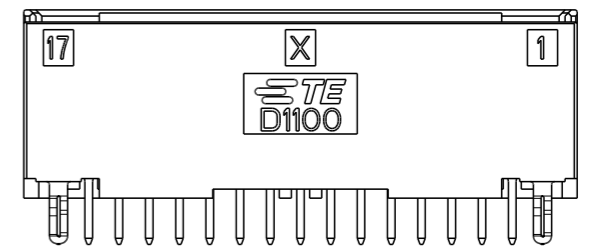
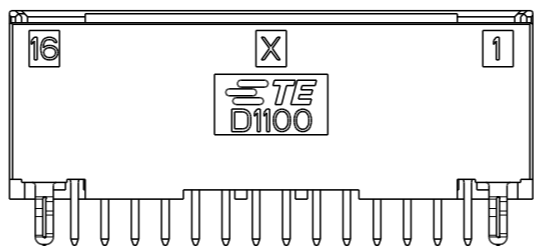
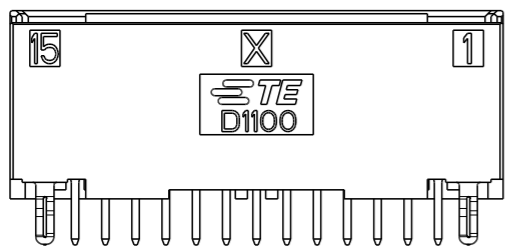
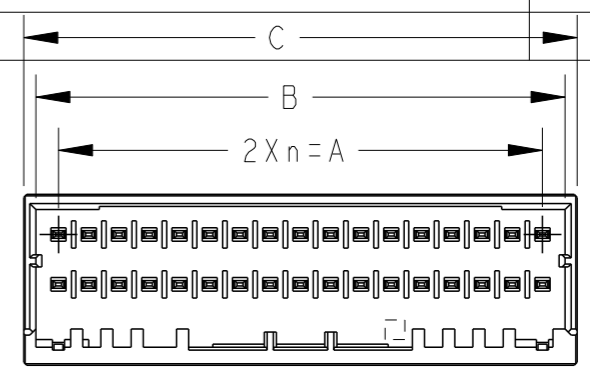
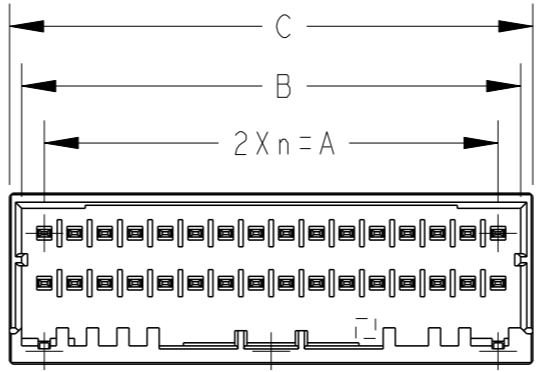
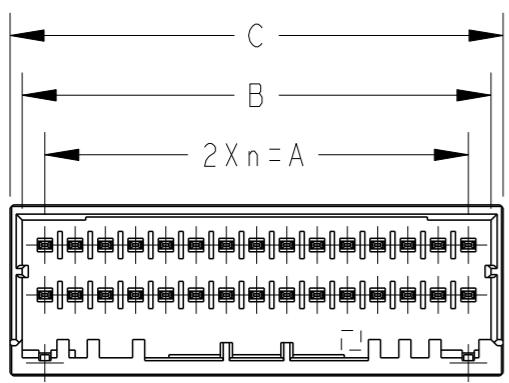

30POS(X-KEY)
1-1871315-5

32POS(X-KEY)
1-1871315-6

34POS(X-KEY)
1-1871315-7

NOTES: 2-1871315-7 IS SYMMETRY WITH 1-1871315-7 FOR KEY WAY

THIS DRAWING IS A CONTROLLED DOCUMENT.		DWN 03DEC2020 FISHER, ZHU	TE Connectivity				
DIMENSIONS: mm		CHK 03DEC2020 RICK, BIAN			NAME DYNAMIC D1100 SERIES HDR ASSY, V-TYPE, PRE-TIN 22~40POS		
TOLERANCES UNLESS OTHERWISE SPECIFIED: 0 PLC ±0.5 1 PLC ±0.13 2 PLC ±0.13 3 PLC ±0.013 4 PLC ±0.0001 ANGLES ±		APVD 03DEC2020 RICK, BIAN	PRODUCT SPEC 108-78298 108-137366	SIZE A3	CAGE CODE 00779	DRAWING NO C=1871315	RESTRICTED TO -
MATERIAL TBD		APPLICATION SPEC 114-5377	WEIGHT -	SCALE 2:1		SHEET 3 OF 3	REV D1
CUSTOMER DRAWING							

printed on 3 Feb 2021 16:39 (China Standard Time) from TE304429

单击下面可查看定价，库存，交付和生命周期等信息

[>>TE Connectivity\(泰科\)](#)