

LOC	DIST	REVISIONS			
CM	00	REV	DATE	BY	APP'D
		K	31MAY2007	KW	CC
		K1	15JAN10	KK	AEK

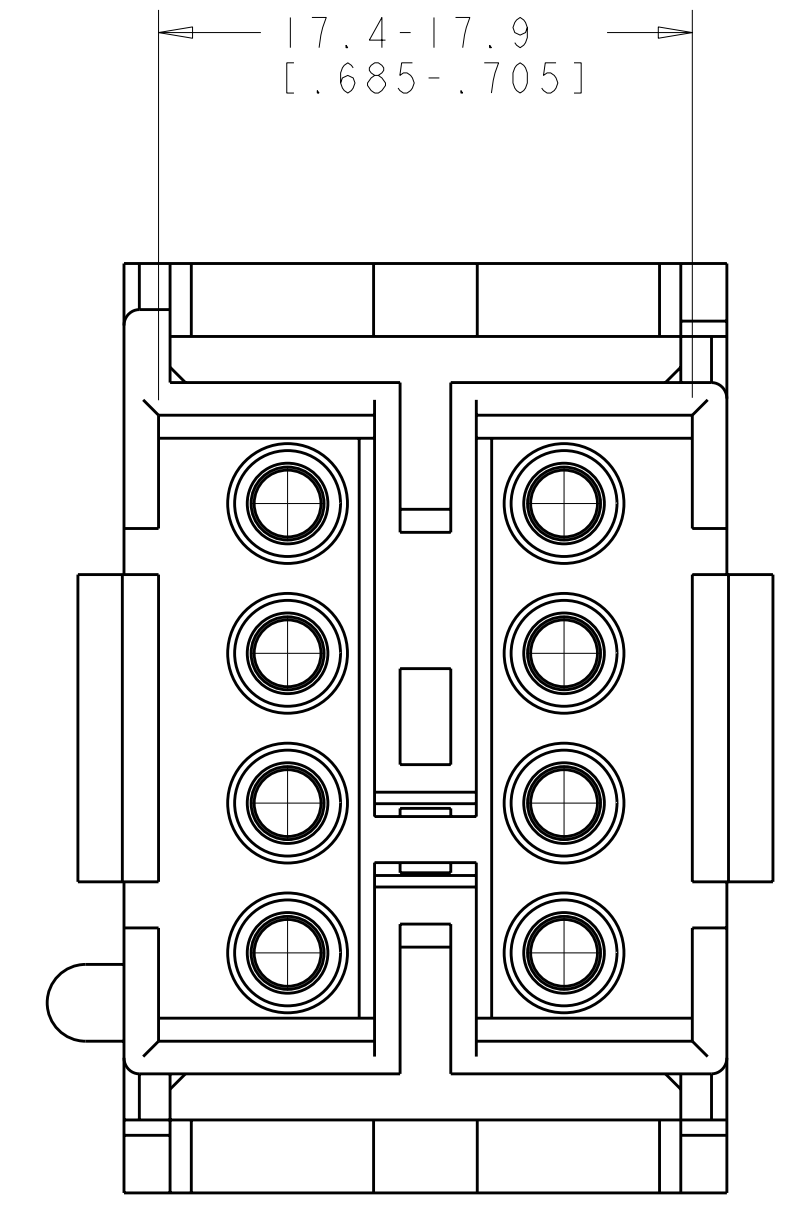

- USE TERMINALS 61208, 61209, 61212, 61213.
  - MATES WITH PLUG 480374.
  - PANEL MUST BE PINCHED SO THAT THE HOUSING ENTERS THE PANEL IN THE SAME DIRECTION AS THE PUNCH.
- ⚠️ OBSOLETE PARTS: OBSOLETE CIS STREAMLINING PER D.RENAUD/D.SINISI

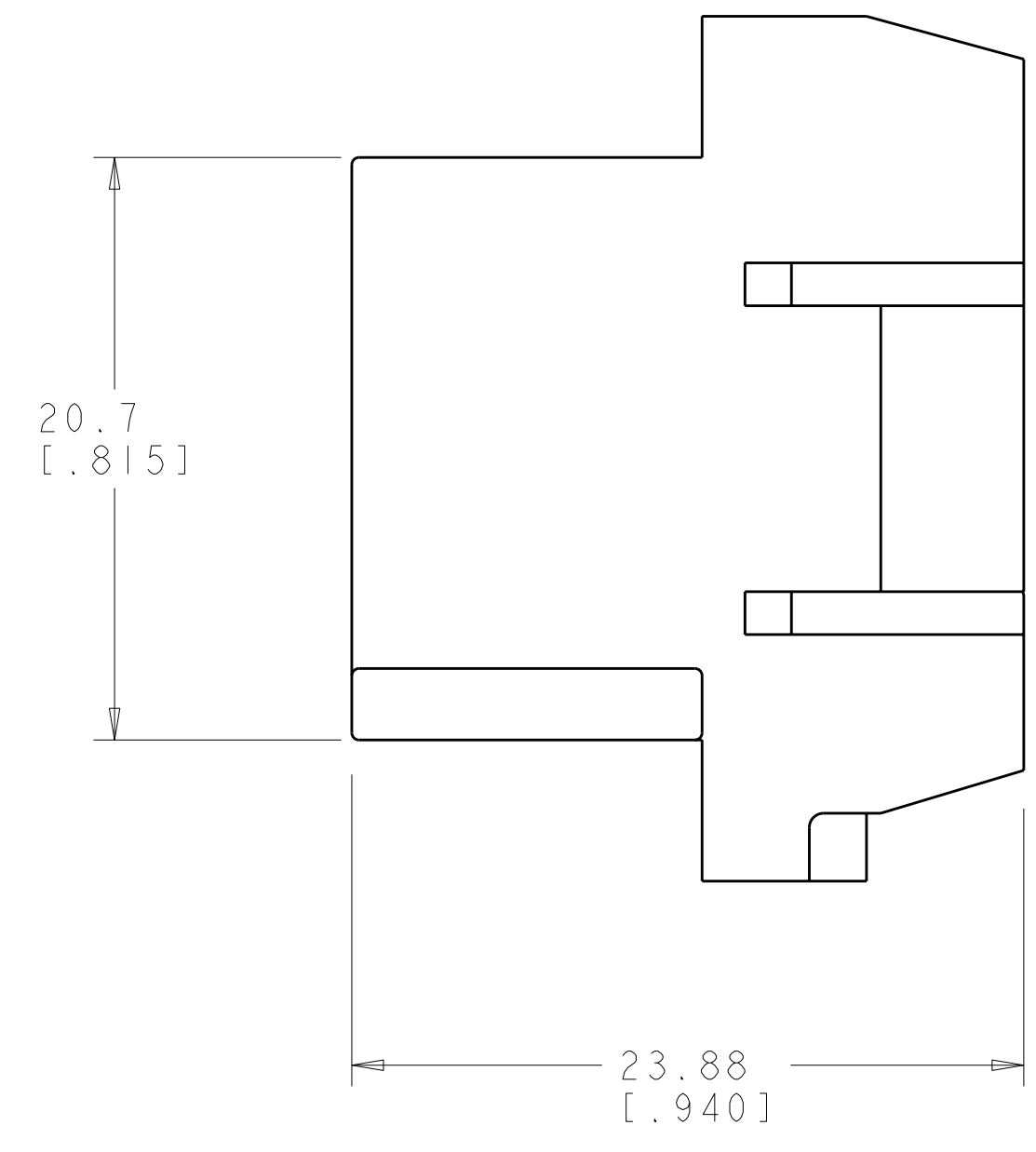
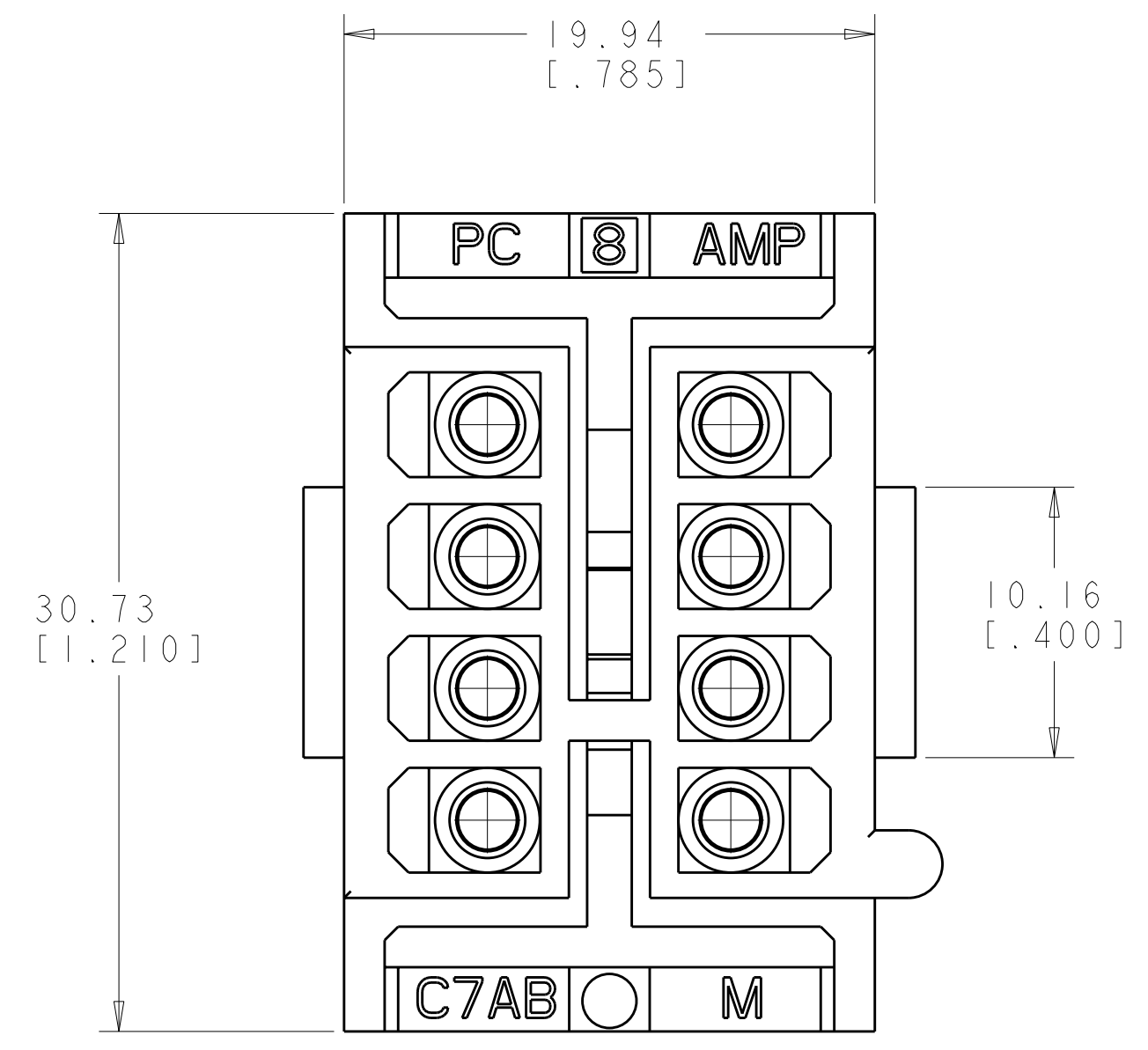
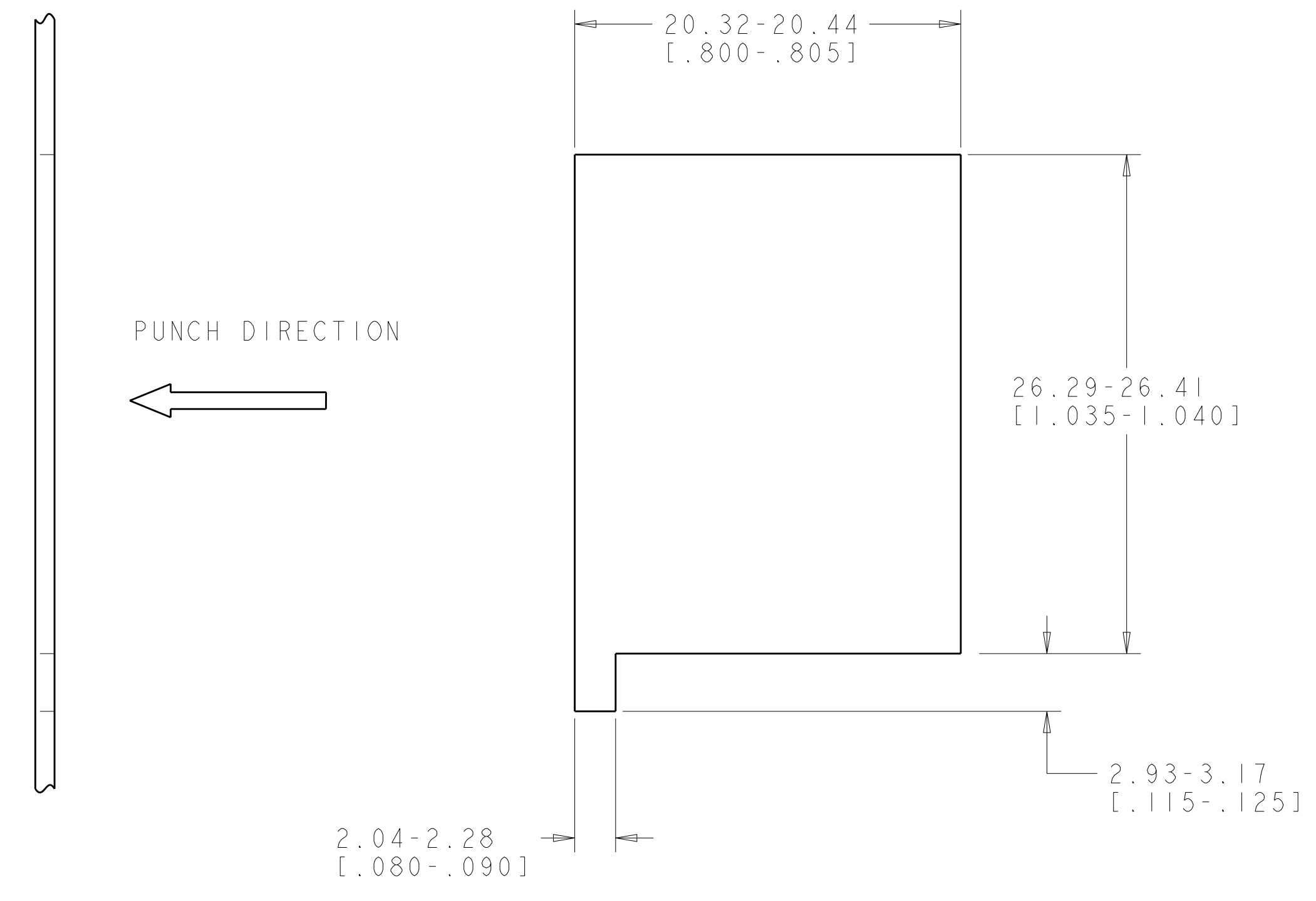
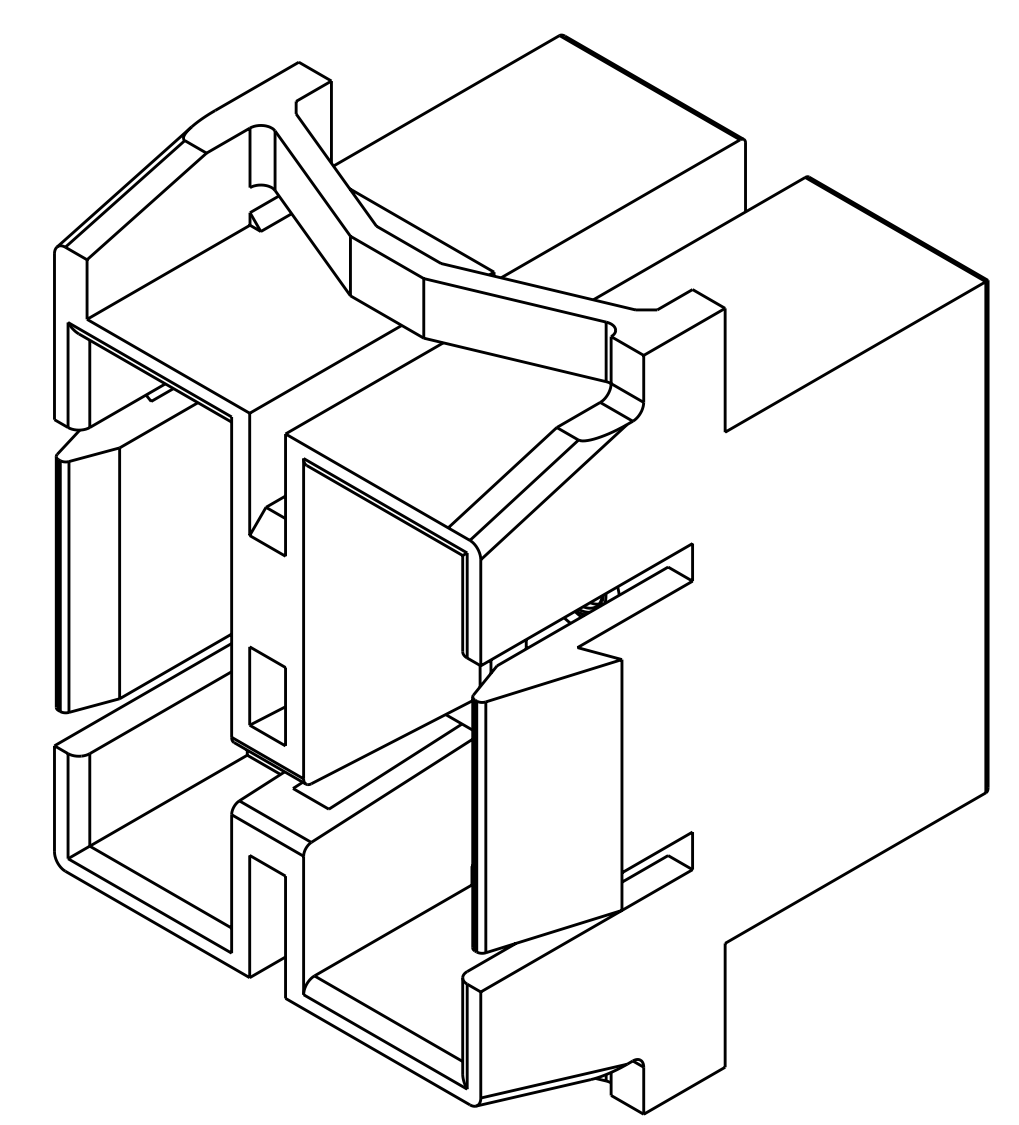
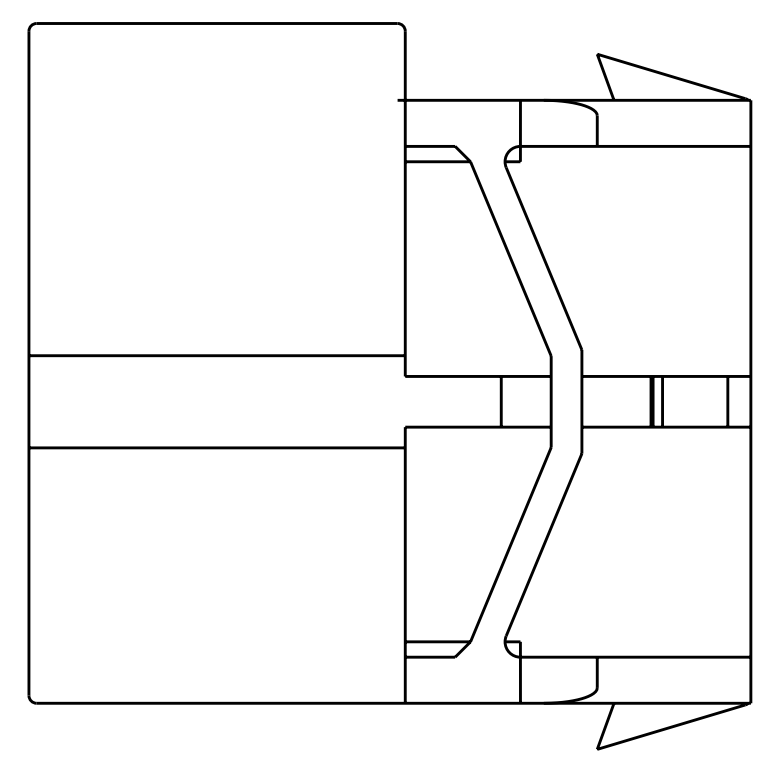

RECOMMENDED MOUNTING HOLE  
 FOR PANEL THICKNESS 0.51-1.52 [0.020-0.060]

OBSOLETE	0.293 IN <sup>3</sup>	NYLON, BLACK	1-480373-1
	0.293 IN <sup>3</sup>	NYLON, NATURAL	1-480373-0
	VOLUME	MATERIAL	PART NUMBER

<small>THIS DRAWING IS UNPUBLISHED. RELEASED FOR PUBLICATION BY TYCO ELECTRONICS CORPORATION. ALL RIGHTS RESERVED.</small> <small>THIS IS SUBJECT TO CHANGE WITHOUT NOTICE. TYCO ELECTRONICS CORPORATION SHALL BE CONTACTED FOR THE LATEST REVISION.</small>		DWN: R. WHITAKER 31MAY2007 CHK: C. CASH 31MAY2007 APVD: C. CASH 31MAY2007	Tyco Electronics Harrisburg, PA 17105-3608
DIMENSIONS: mm [INCHES]	TOLERANCES UNLESS OTHERWISE SPECIFIED: 0 PLC ± 1 PLC ±0.38 [0.015] 2 PLC ± 3 PLC ± 4 PLC ± ANGLES ±1°	NAME: CAP. 8 CIRCUIT, AUTOMOTIVE MATE-N-LOK(TM) PRODUCT SPEC: APPLICATION SPEC:	SIZE: A   00779   C=480373 RESTRICTED TO:
MATERIAL: SEE TABLE	FINISH: -	WEIGHT: -	CUSTOMER DRAWING
		SCALE: 4:1	SHEET 1 OF 1 REV: K1

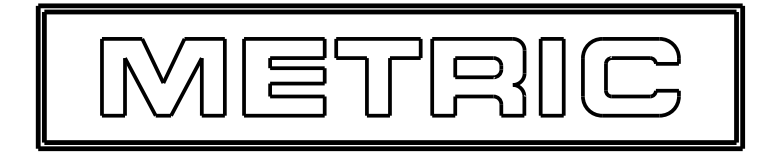

单击下面可查看定价，库存，交付和生命周期等信息

[>>TE Connectivity\(泰科\)](#)