

4

3

2

1

THIS DRAWING IS UNPUBLISHED.

RELEASED FOR PUBLICATION

20

© COPYRIGHT 20

BY -

ALL RIGHTS RESERVED.

REVISIONS

P	LTR	DESCRIPTION	DATE	DWN	APVD
B		ECR-15-013759	27SEP2015	DW	CW
B1		ECR-16-011988	25AUG2016	YC	CW
B2		ECR-18-017123	15DEC2018	KW	CW
C		ECR-21-106515	09JUL2021	SQ	CW

PANEL CUT FOR INSERTS FOR USE
WITHOUT HOODS / HOUSINGS

不使用防护外壳时芯件的安装开孔图

NOTES:

1. TECHNICAL CHARACTERISTICS:
INSULATION MATERIAL: PC
RATED VOLTAGE: 500V
RATED CURRENT: 16A
INSULATION RESISTANCE: $\geq 400M\Omega$
RATED IMPULSE VOLTAGE: 6KV
POLLUTION DEGREE: 3
FLAMMABILITY: UL94V-0
MATING CYCLES: 500 CYCLES
WIRE RANGE: $0.5mm^2 \sim 2.5mm^2$ (AWG20-AWG14)
CONTACT TYPE: SCREW CLAMP (M3)

10X M3 SCREW, RECOMMENDED
TIGHTENING TORQUE 0.5Nm
10X M3螺丝, 推荐锁紧力矩0.5Nm

M4 SCREW, RECOMMENDED
TIGHTENING TORQUE 1.2Nm
M4螺丝, 推荐锁紧力矩1.2Nm

注释:

1. 技术参数:
绝缘材料: PC
额定电压: 500V
额定电流: 16A
绝缘电阻: $\geq 400M\Omega$
脉冲电压: 6KV
污染等级: 3
阻燃等级: UL94V-0
插拔次数: 500次
接线范围: $0.5mm^2 \sim 2.5mm^2$ (AWG20-AWG14)
接线类型: 螺丝压接 (M3)

4X M3 SCREW, RECOMMENDED
TIGHTENING TORQUE 0.5Nm
4X M3螺丝, 推荐锁紧力矩0.5Nm

TYPE 1, T2040102201-000, WITH LOGO
类型 1, T2040102201-000, 带LOGO

THIS DRAWING IS A CONTROLLED DOCUMENT.

DWN 14APR2015

GINO YAO

CHK 14APR2015

CHRIS WANG

APVD 14APR2015

XIANG XU

PRODUCT SPEC

108-137044

APPLICATION SPEC

114-137044

WEIGHT

-

CUSTOMER DRAWING

NAME
HE-010-F

SIZE CAGE CODE DRAWING NO RESTRICTED TO

A300779 C-T2040102201000 -

SCALE 1:1 SHEET 1 OF 2 REV C

DIMENSIONS:

mm

TOLERANCES UNLESS
OTHERWISE SPECIFIED:

0 PLC	±-
1 PLC	±-
2 PLC	±-
3 PLC	±-
4 PLC	±-
ANGLES	±-
FINISH	-

MATERIAL

-

-

TE Connectivity

1470-19 (3/13)

Downloaded From Oneyac.com

THIS DRAWING IS UNPUBLISHED.

RELEASED FOR PUBLICATION

20

© COPYRIGHT 20 BY -

ALL RIGHTS RESERVED.

REVISIONS

P	LTR	DESCRIPTION	DATE	DWN	APVD
-	-	SEE SHEET 1	-	-	-

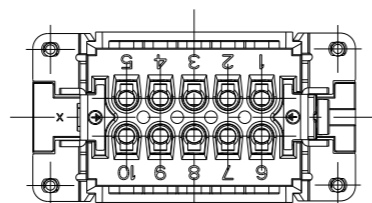
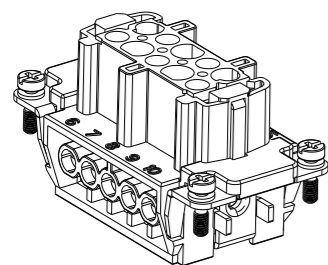

TYPE 2, T2040102201-001, WITHOUT LASER SIDE MARK
 类型 2, T2040102201-001, 不带侧面激光标识

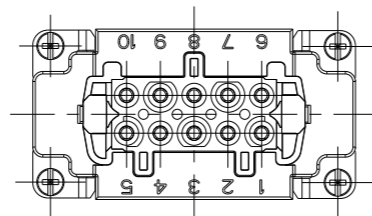
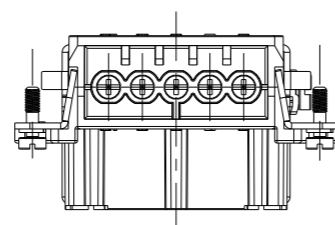
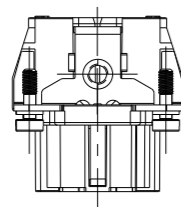

NOTE:
 ALL SPEC REFER TO TYPE 1

注释:
 所有产品规范参照 TYPE 1

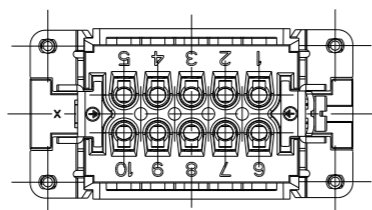
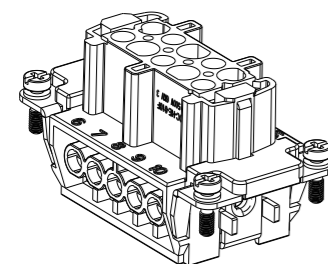

TYPE 3, T2049102201-000, WITHOUT LASER LOGO
 类型 3, T2049102201-000, 不带激光LOGO标识

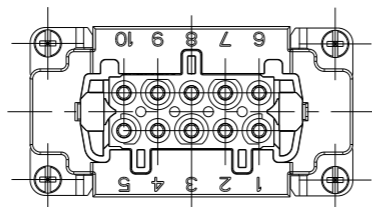
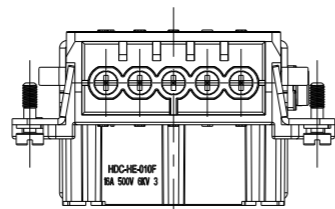
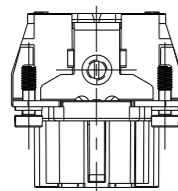

T2040102201-000	HE-010-F	HE-010 FEMALE INSERT HE-010 母插	TYPE 1
T2040102201-001	HE-010-F	HE-010 FEMALE INSERT, WITHOUT LASER SIDE MARK HE-010 母插, 无激光侧面标识	TYPE 2
T2049102201-000	HE-010-F	HE-010 FEMALE INSERT, WITHOUT LOGO HE-010 母插, 无LOGO	TYPE 3
PART NUMBER 料号	PART DESCRIPTION 描述		TYPE 类型

THIS DRAWING IS A CONTROLLED DOCUMENT.

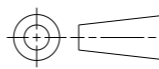
DIMENSIONS: mm	TOLERANCES UNLESS OTHERWISE SPECIFIED:
	0 PLC ±-
	1 PLC ±-
	2 PLC ±-
	3 PLC ±-
	4 PLC ±-
	ANGLES ±-
MATERIAL	FINISH
-	-
-	-

DWN	14APR2015
GINO YAO	
CHK	14APR2015
CHRIS WANG	
APVD	14APR2015
XIANG XU	
PRODUCT SPEC	108-137044
APPLICATION SPEC	114-137044
WEIGHT	-
CUSTOMER DRAWING	

 TE Connectivity		NAME		HE-010-F
		SIZE	CAGE CODE	DRAWING NO
A3		00779	C-T2040102201000	
SCALE		1:1	SHEET	2 OF 2
			REV	C

单击下面可查看定价，库存，交付和生命周期等信息

[>>TE Connectivity\(泰科\)](#)