

THIS DRAWING IS UNPUBLISHED. RELEASED FOR PUBLICATION 20
 © COPYRIGHT 20 BY - ALL RIGHTS RESERVED.

REVISIONS				DATE	DWN	APVD
P	LTR	DESCRIPTION				
	A1	REVISED PER ECR-15-006926	05MAY15	JR	KR	

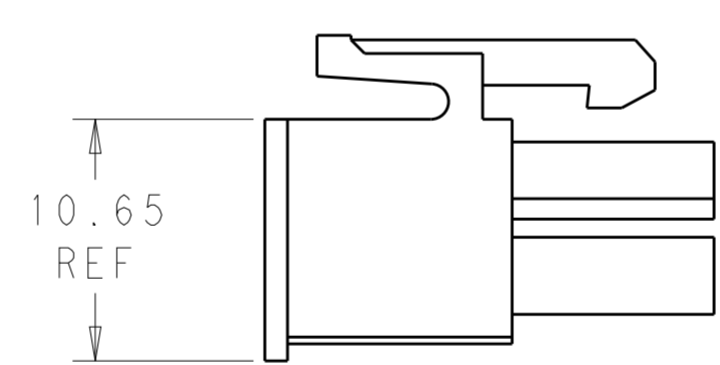

SCALE 3:1
FOR -2 PART ONLY

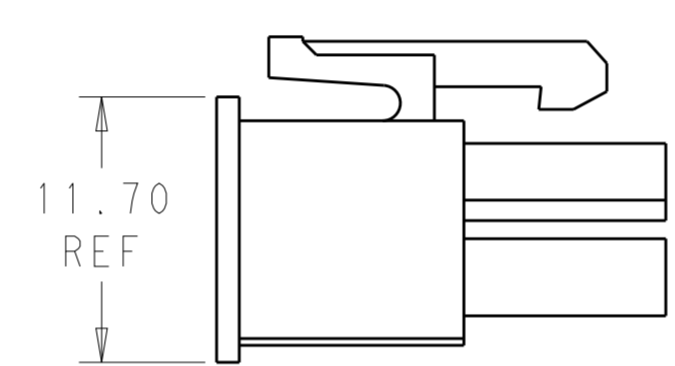
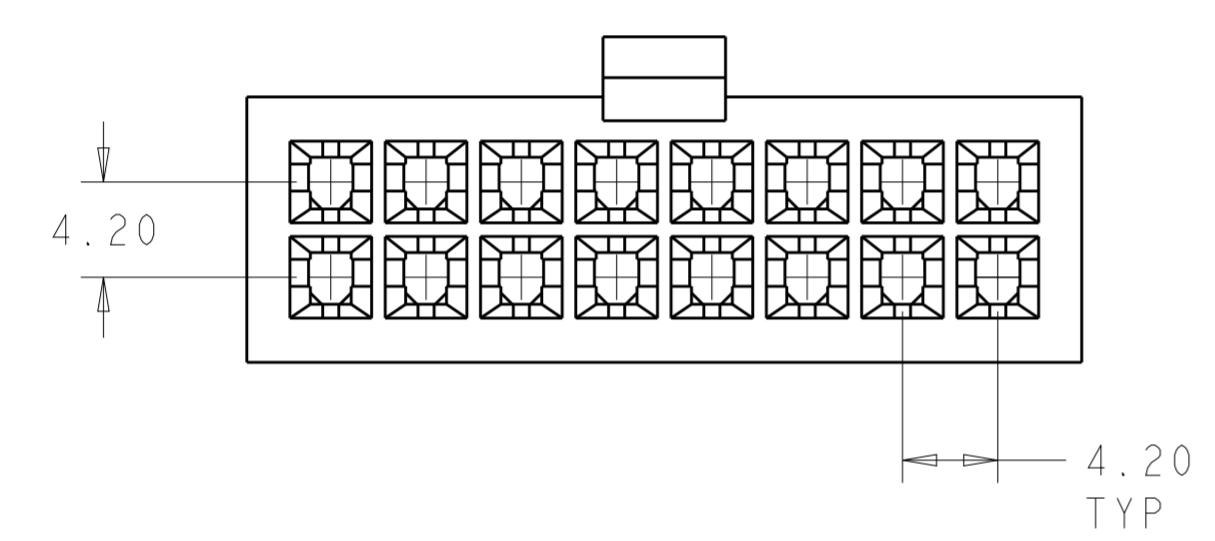
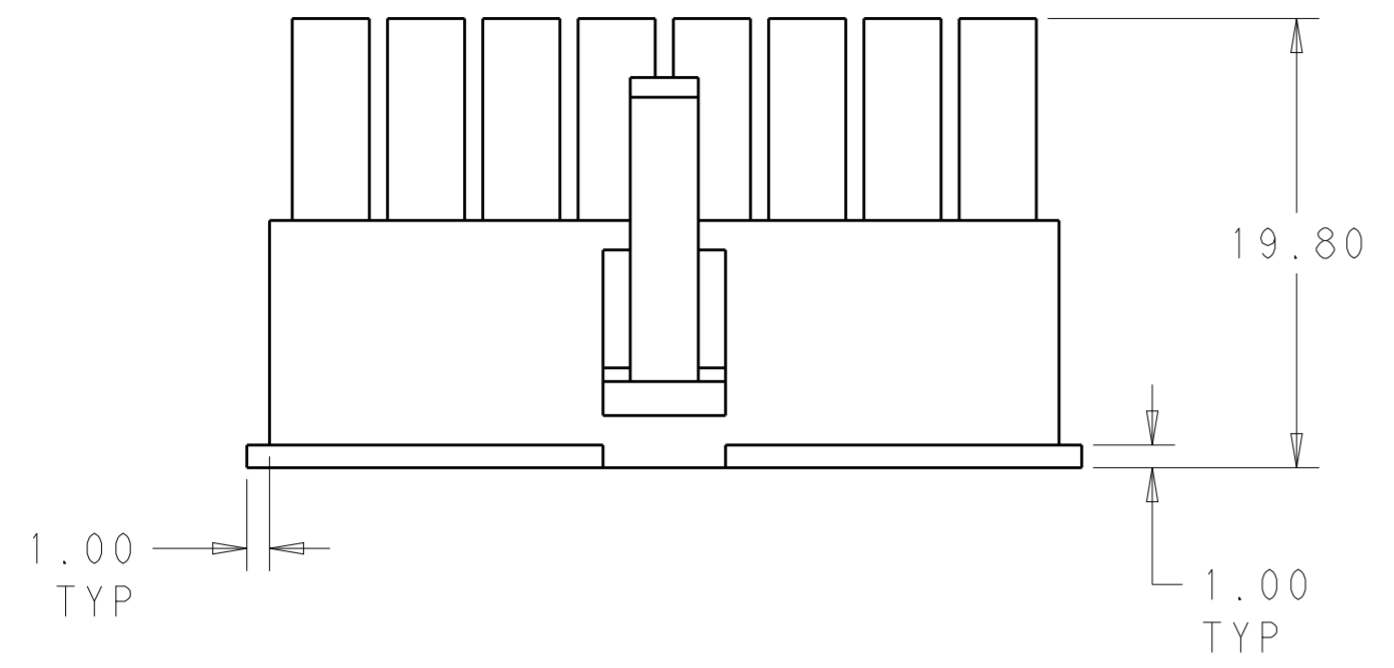
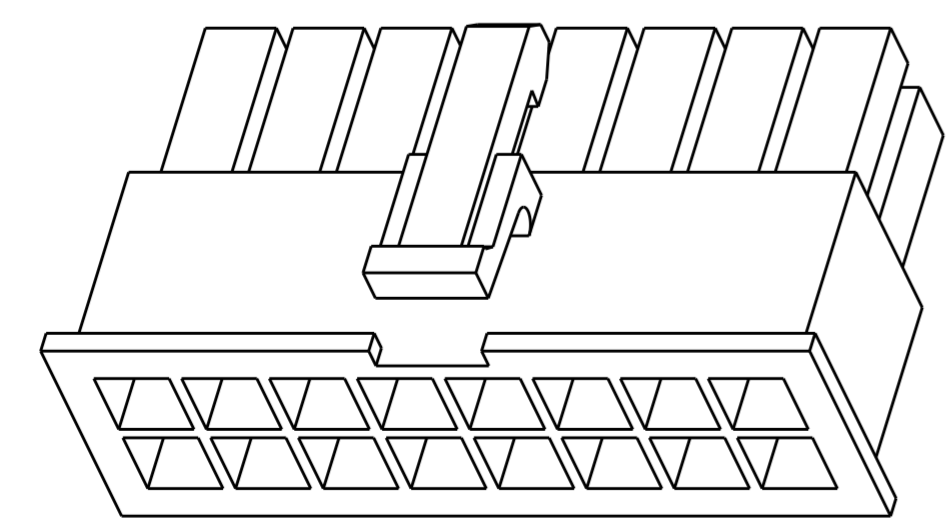
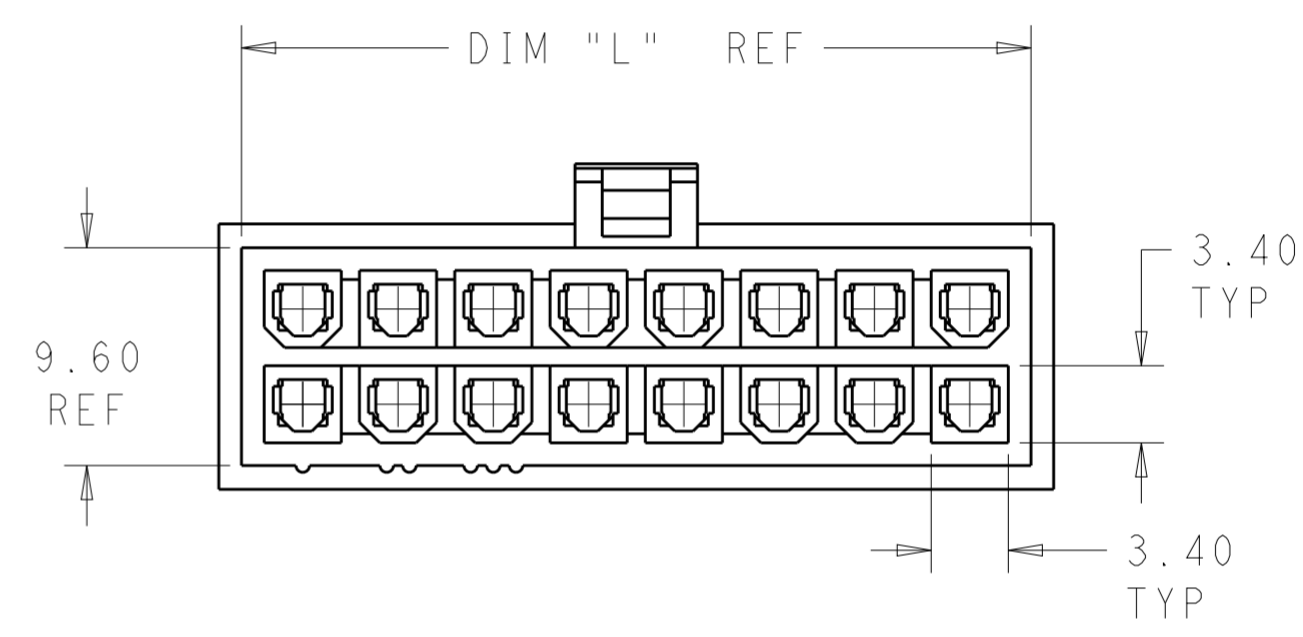

51.60	24	2-1969614-4
47.40	22	2-1969614-2
43.20	20	2-1969614-0
39.00	18	1-1969614-8
34.80	16	1-1969614-6
30.60	14	1-1969614-4
26.40	12	1-1969614-2
22.20	10	1-1969614-0
18.00	8	1969614-8
13.80	6	1969614-6
9.60	4	1969614-4
5.40	2	1969614-2
DIM L	NO. OF POS	PART NO.

THIS DRAWING IS A CONTROLLED DOCUMENT.		DWN	JR RUTH	18JAN13
DIMENSIONS:		CHK	KURT RANDOLPH	18JAN13
mm	TOLERANCES UNLESS OTHERWISE SPECIFIED:	APVD	KURT RANDOLPH	18JAN13
	0 PLC ±	PRODUCT SPEC		
	1 PLC ±	APPLICATION SPEC		
	2 PLC ±0.25	WEIGHT		
	3 PLC ±	Customer Drawing		
	4 PLC ±	SCALE 3:1		
	ANGLES ±	SHEET 1 OF 1		
	FINISH	REV A1		
MATERIAL	NYLON 6/6, V0	COLOR-NATURAL		



TE Connectivity

RECEPTACLE HOUSING, VAL-U-LOK

SIZE: A200779 CAGE CODE: C-1969614 DRAWING NO: - RESTRICTED TO: -

单击下面可查看定价，库存，交付和生命周期等信息

[>>TE Connectivity\(泰科\)](#)