

REVISIONS				
P	LTR	DESCRIPTION	DATE	APVD
B	I	REVISED PER ECR-10-019377	30SEP2010	HMR TM
C		REVISED PER ECR-14-000206	26DEC2013	PV RB

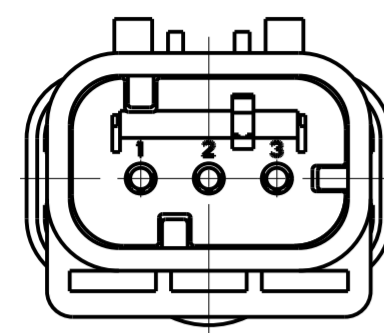

1717673-2
SCALE 2:1

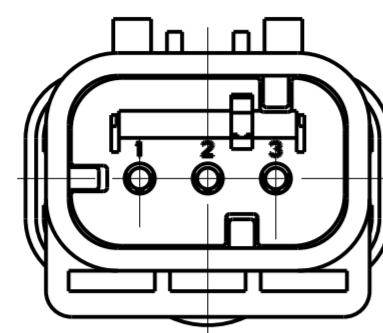

1717673-3
SCALE 2:1

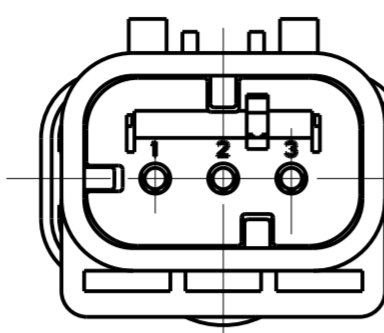

1717673-4
SCALE 2:1

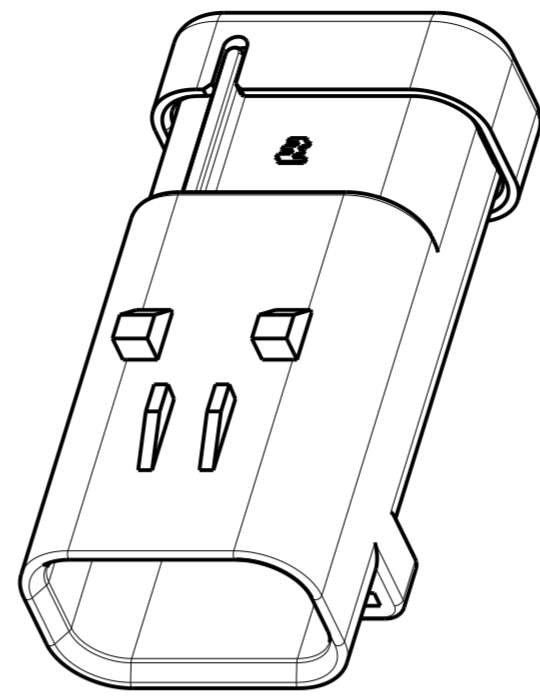

SCALE 2:1

- ① MATERIAL: 15% GLASS FILLED THERMOPLASTIC
COLOR: BLACK
- ② MATERIAL: 15% GLASS FILLED THERMOPLASTIC
COLOR: (SEE TABLE)
- ③ MATERIAL: SILICONE
COLOR: GREEN

4. WIRE INSULATION RANGE: $\varnothing 2.24 \sim \varnothing 3.94$

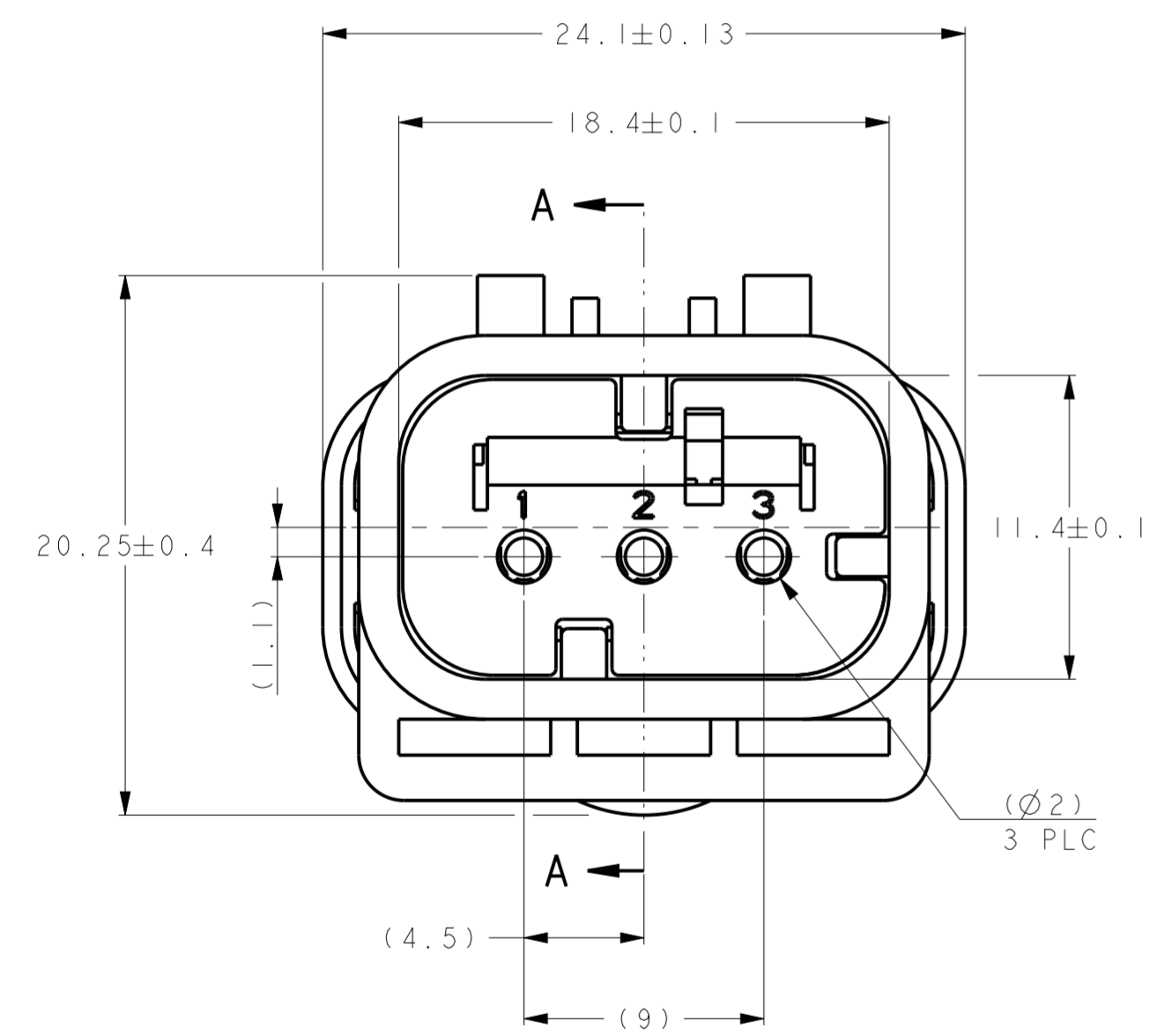

1717673-1 SHOWN

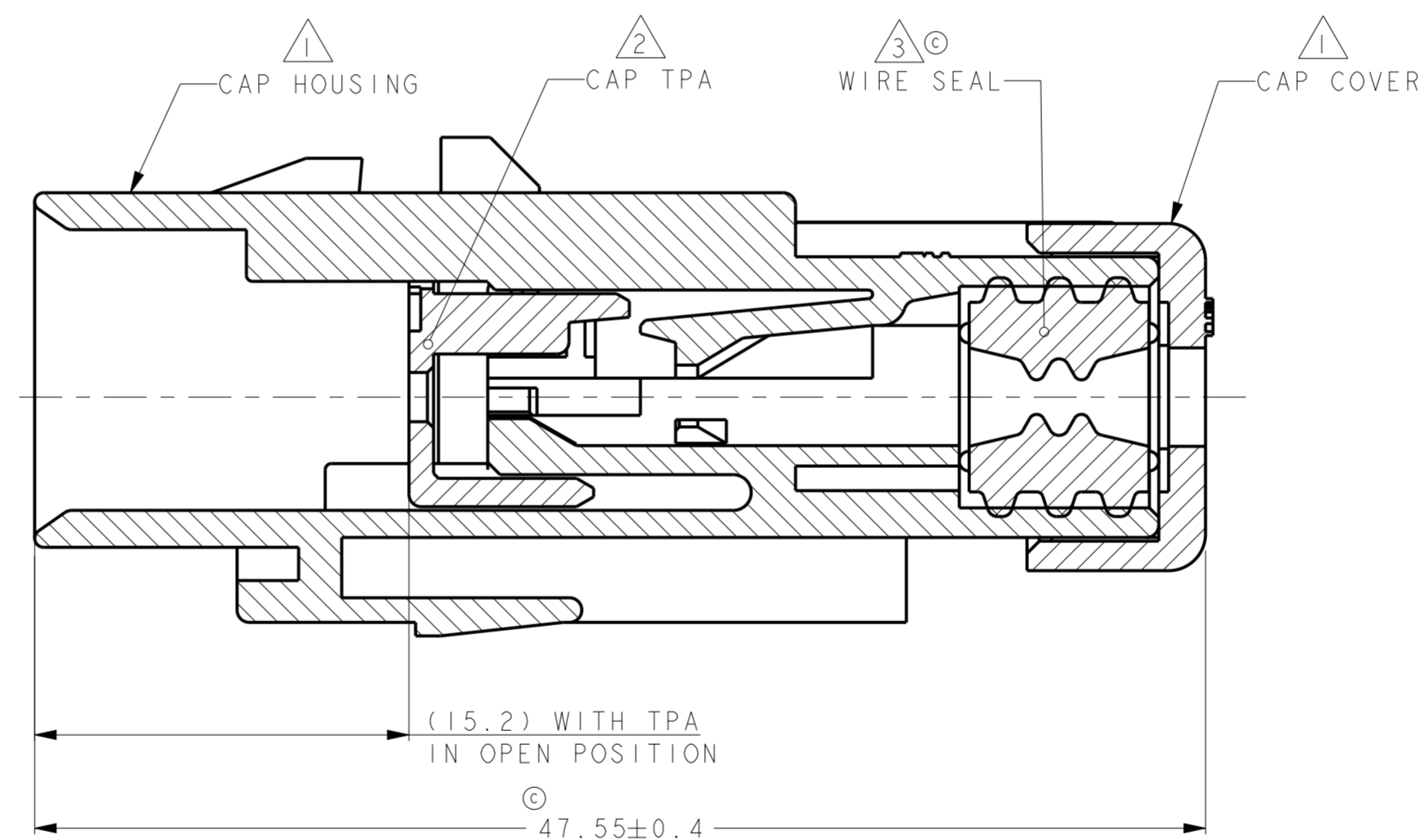

A - A
OPEN POSITION

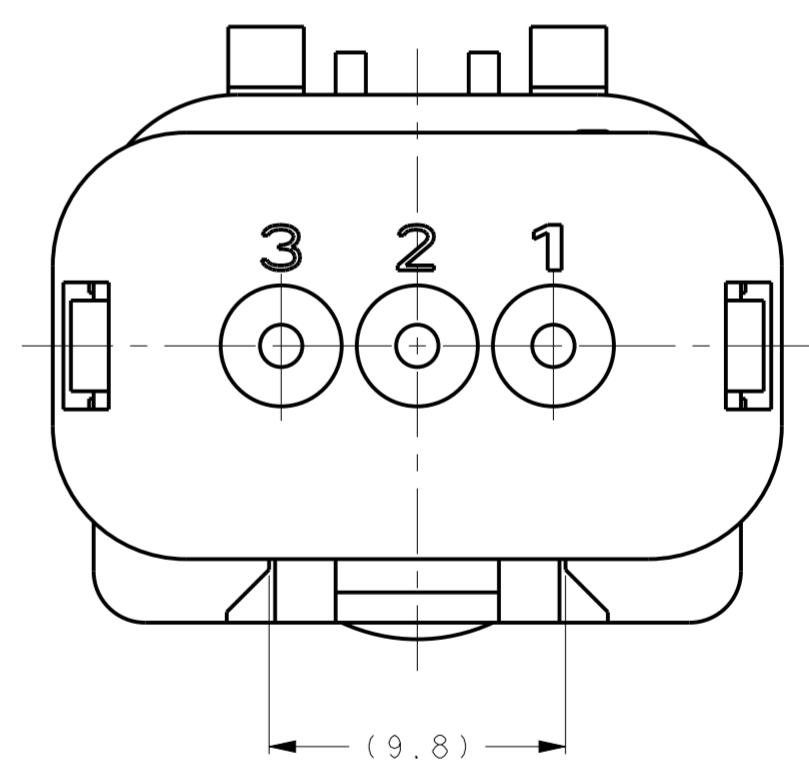

TPA COLOR	PART NUMBER
GREEN	1717673-4
YELLOW	1717673-3
GRAY	1717673-2
RED	1717673-1

THIS DRAWING IS A CONTROLLED DOCUMENT.		DWN Y. KATO 15JAN2004	TE Connectivity
DIMENSIONS: mm		CHK S. MANABE 15JAN2004	
TOLERANCES UNLESS OTHERWISE SPECIFIED		APVD S. MANABE 15JAN2004	
0 PLC ± 1 PLC ± 2 PLC ± 3 PLC ± 4 PLC ± ANGLES ± FINISH -		PRODUCT SPEC 108-2184 APPLICATION SPEC 114-13065 WEIGHT -	
MATERIAL		Customer Drawing	NAME CAP ASSY, 3 POS. BRACKET REVERSE TYPE AMP SEAL 16 SIZE CAGE CODE DRAWING NO A200779 C-1717673 RESTRICTED
SCALE 4:1		SHEET 1 OF 1	REV C

单击下面可查看定价，库存，交付和生命周期等信息

[>>TE Connectivity\(泰科\)](#)