

P	LTR	DESCRIPTION	DATE	DWN	APVD
A		ECN-24-284732	14SEP2024	F. F	M. S

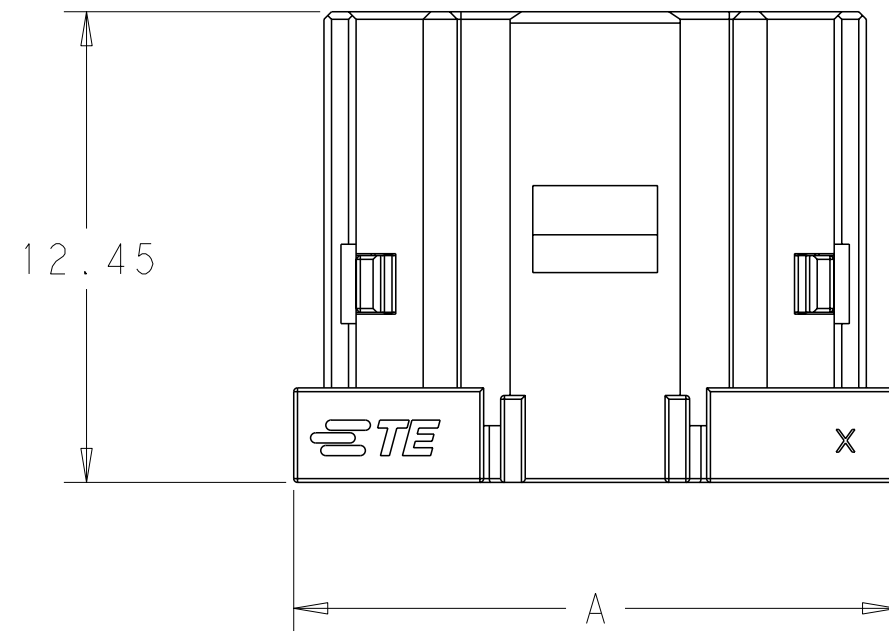

NOTES :

1. MATERIAL: POLYBUTYLENE TEREPHTHALATE.
2. PACKAGING: TRAY INSIDE OF CARTON.

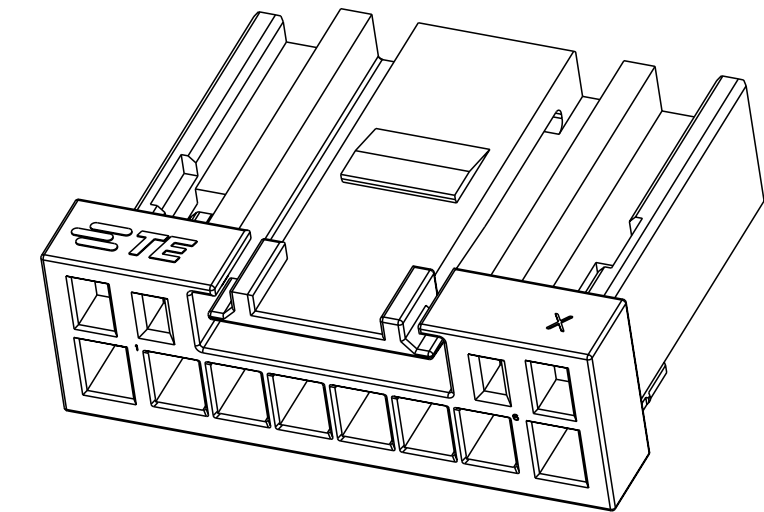

2834663-6 AS SHOWN

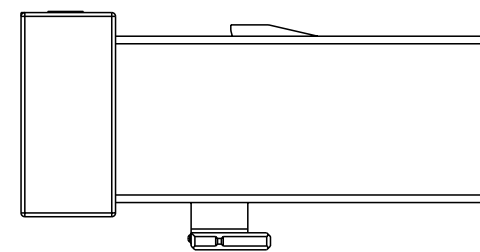
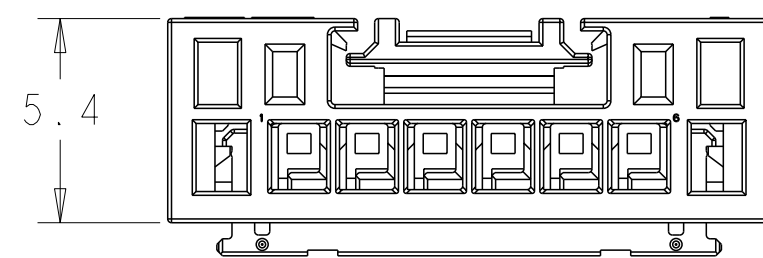

10	1-2834663-0	1-2834672-0	23.15
6	2834663-6	2834672-6	15.95
2	2834663-2	2834672-2	8.75
POSITION	BLACK, X KEY	NATURAL, X KEY	DIMENSION A

10	1-2834686-0	1-2834688-0	23.15
6	2834686-6	2834688-6	15.95
2	2834686-2	2834688-2	8.75
POSITION	BLACK, Y KEY	NATURAL, Y KEY	DIMENSION A

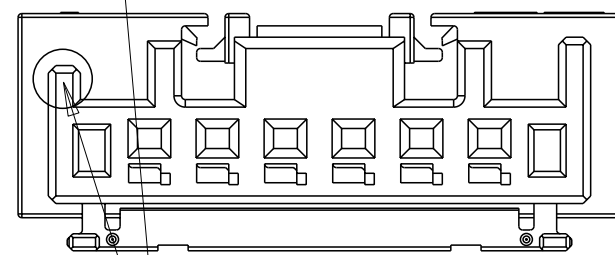
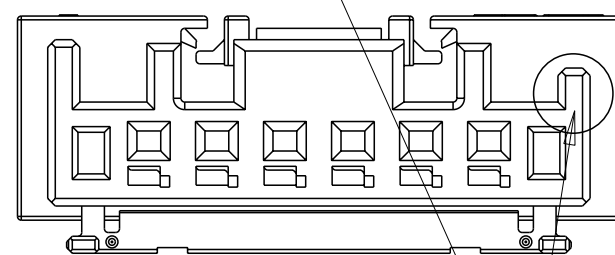
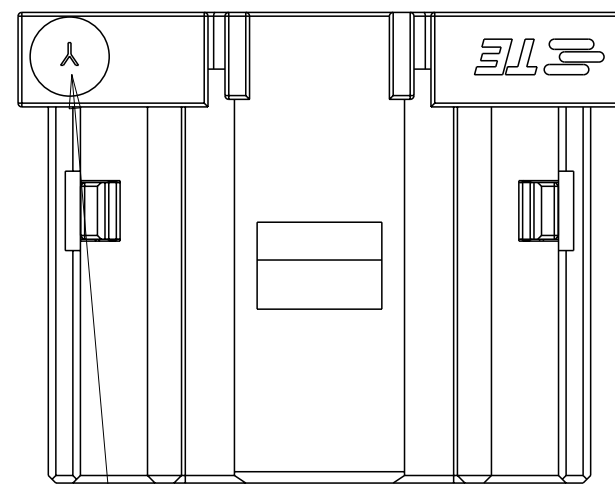
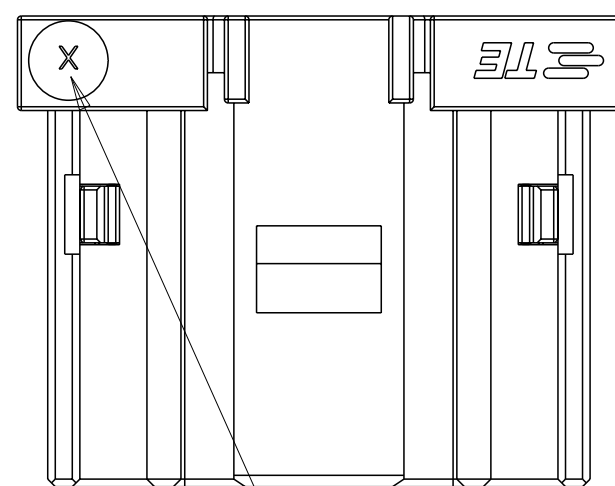

2834663-6, X KEY

2834686-6, Y KEY

THIS DRAWING IS A CONTROLLED DOCUMENT.		DWN FRANK FAN 23JAN2024	TE Connectivity															
DIMENSIONS: mm		CHK GEORGE FU 23JAN2024																
TOLERANCES UNLESS OTHERWISE SPECIFIED:		APVD MING SHI 23JAN2024	NAME DYNAMIC ULTRA RECEPTACLE ASSEMBLY 1.80 MM PITCH															
<table border="1"> <tr><td>0 PLC</td><td>±</td></tr> <tr><td>1 PLC</td><td>±0.50</td></tr> <tr><td>2 PLC</td><td>±0.25</td></tr> <tr><td>3 PLC</td><td>±0.05</td></tr> <tr><td>4 PLC</td><td>±</td></tr> <tr><td>ANGLES</td><td>±</td></tr> <tr><td>FINISH</td><td>±</td></tr> </table>		0 PLC	±	1 PLC	±0.50	2 PLC	±0.25	3 PLC	±0.05	4 PLC	±	ANGLES	±	FINISH	±	PRODUCT SPEC -	SIZE A200779	CAGE CODE C-C2834663
0 PLC	±																	
1 PLC	±0.50																	
2 PLC	±0.25																	
3 PLC	±0.05																	
4 PLC	±																	
ANGLES	±																	
FINISH	±																	
MATERIAL -	finish_spec_2	APPLICATION SPEC -	SCALE 5:1	RESTRICTED TO -														
CUSTOMER DRAWING		WEIGHT -	SHEET 1 OF 1	REV A														

Printed on 18 Sep 2024 15:25 (China Standard Time) from IE310617

单击下面可查看定价，库存，交付和生命周期等信息

[>>TE Connectivity\(泰科\)](#)