

LOC		DIST		REVISIONS			
AD	00	P	LTR	DESCRIPTION	DATE	DMN	APVD
		B1		REVISED PER ECO-10-008611	26APR10	HMR	NE

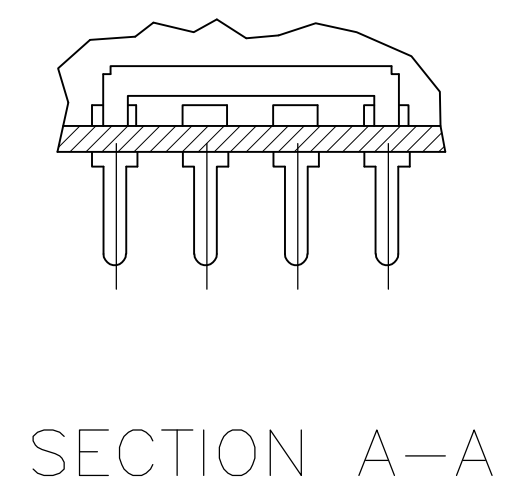
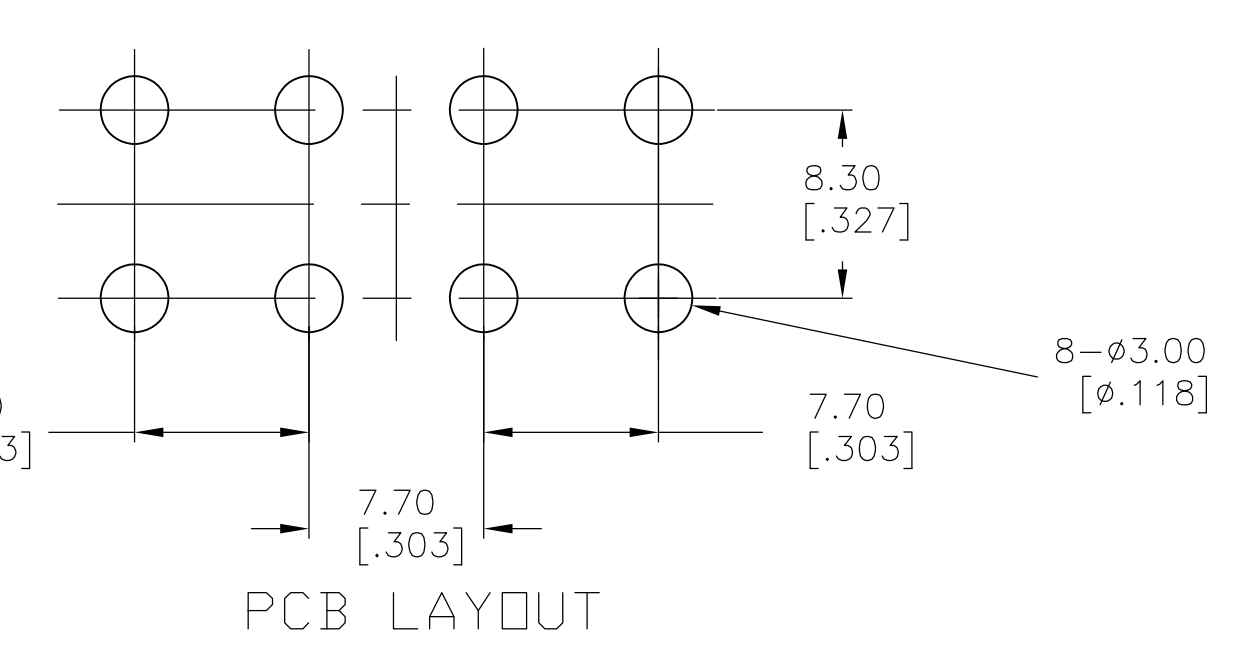
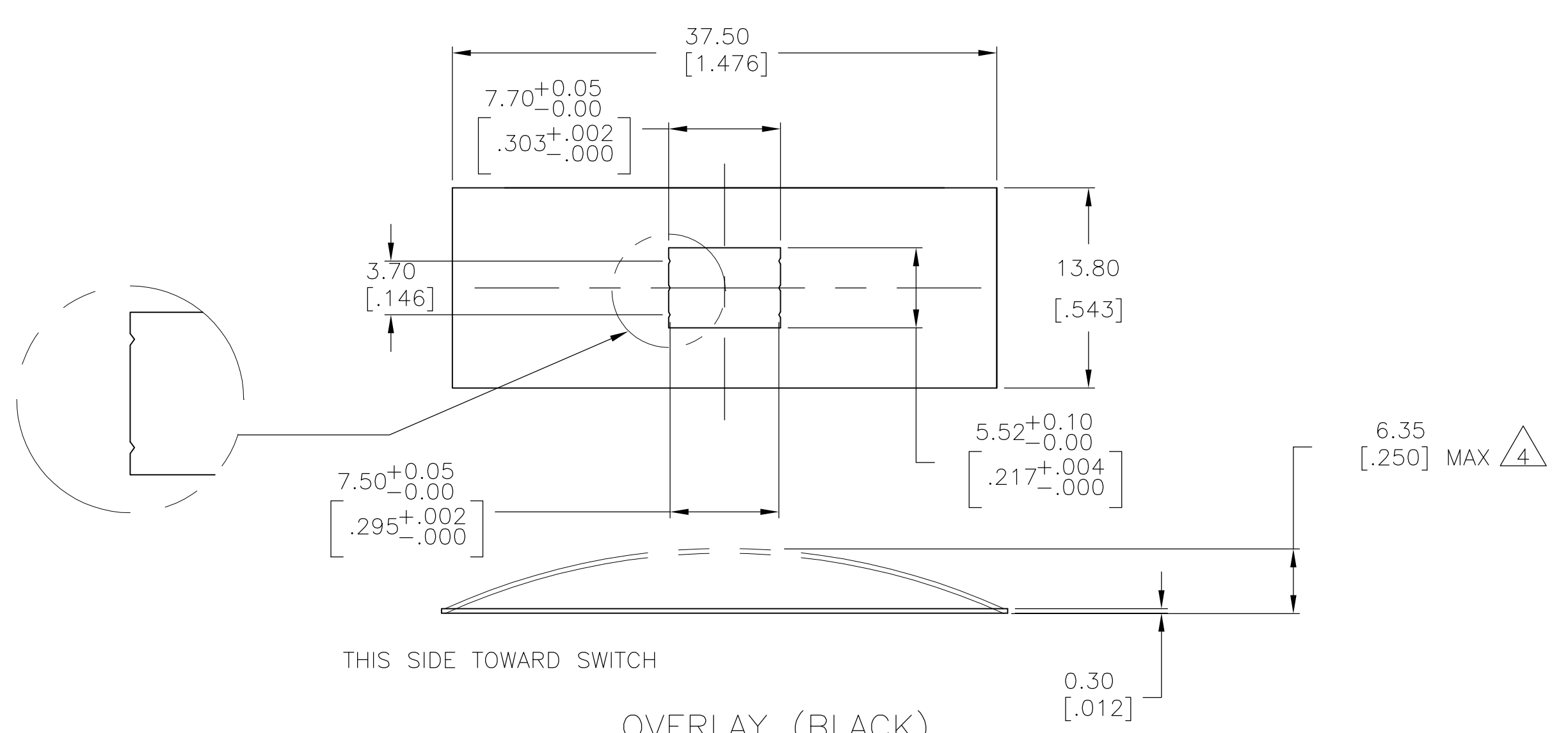
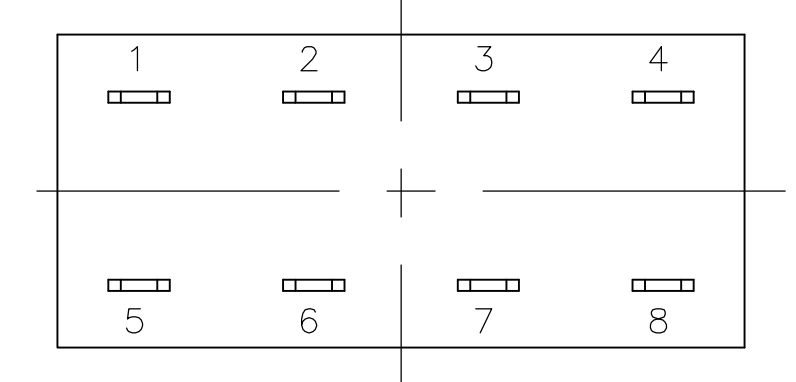
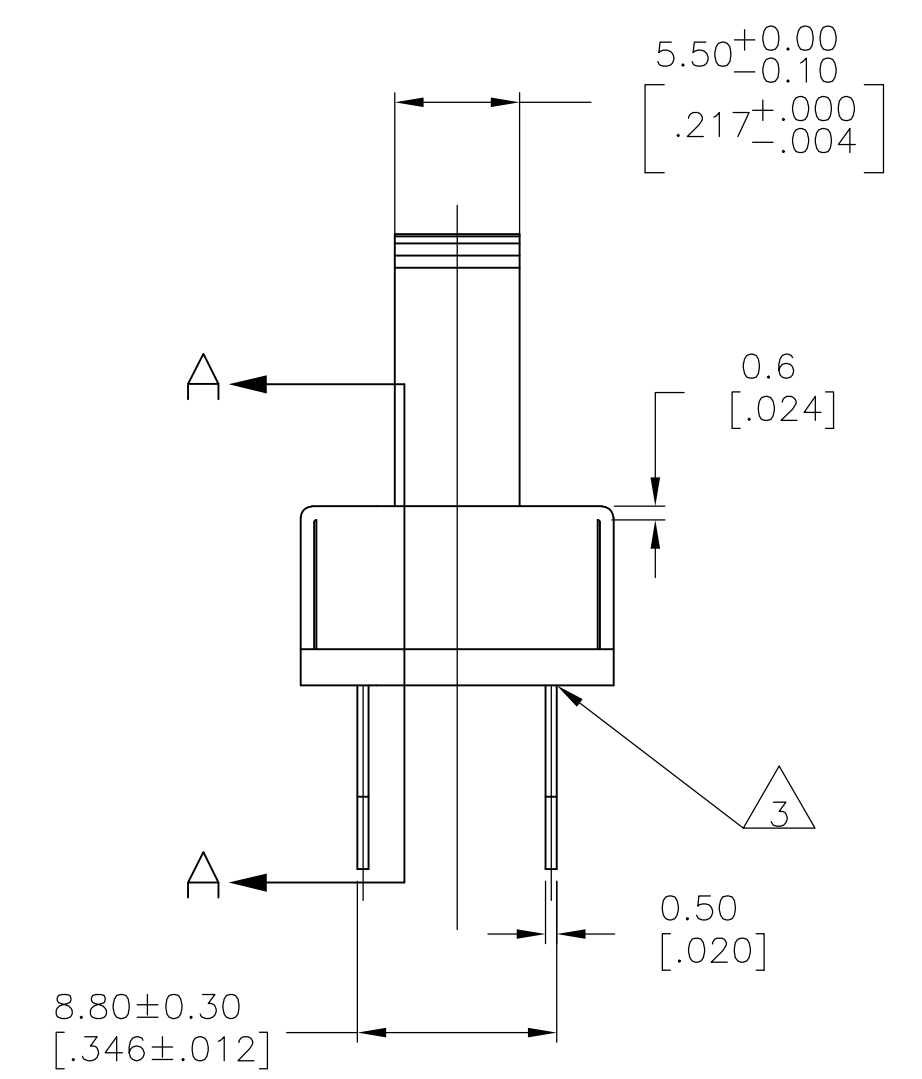
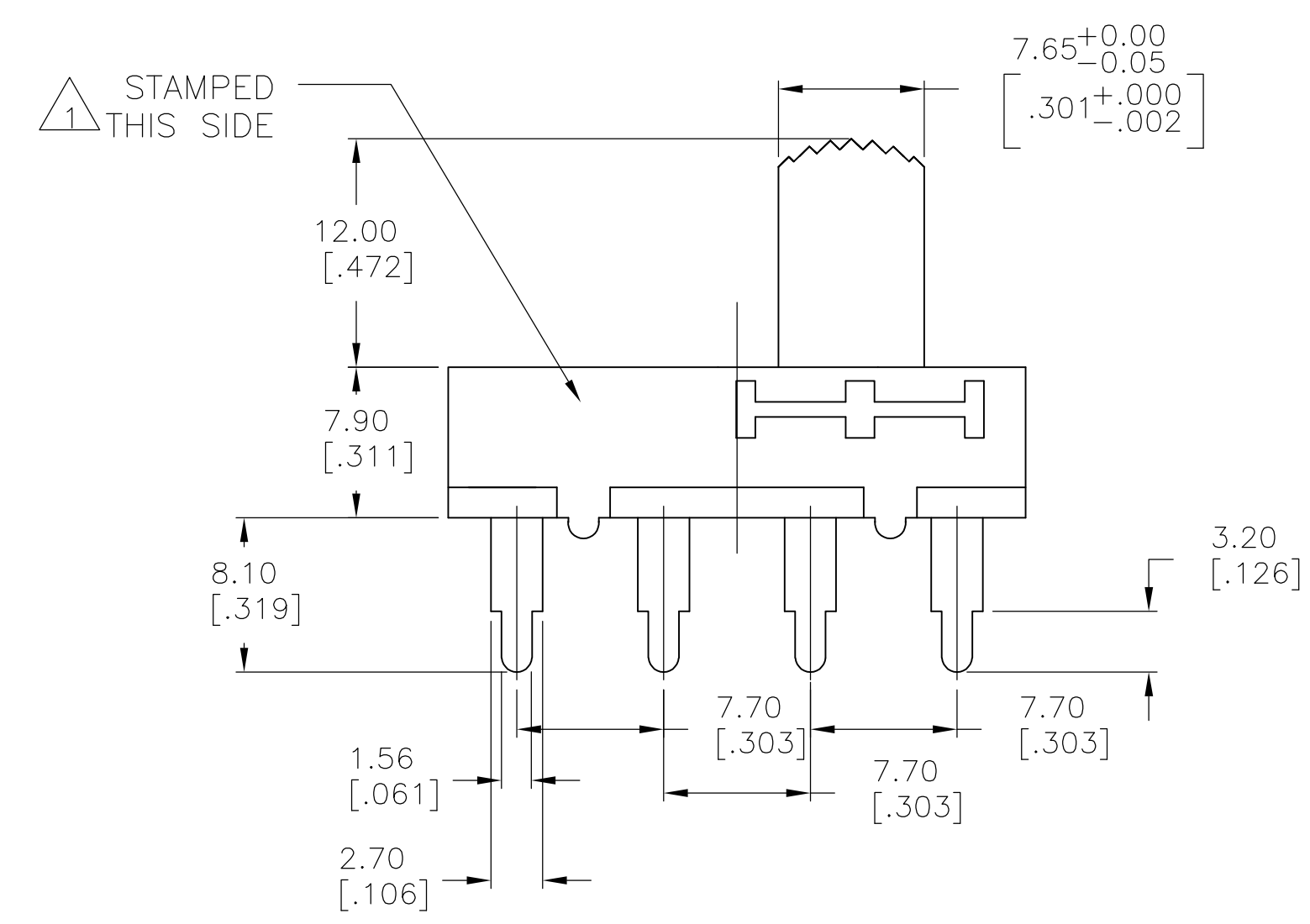
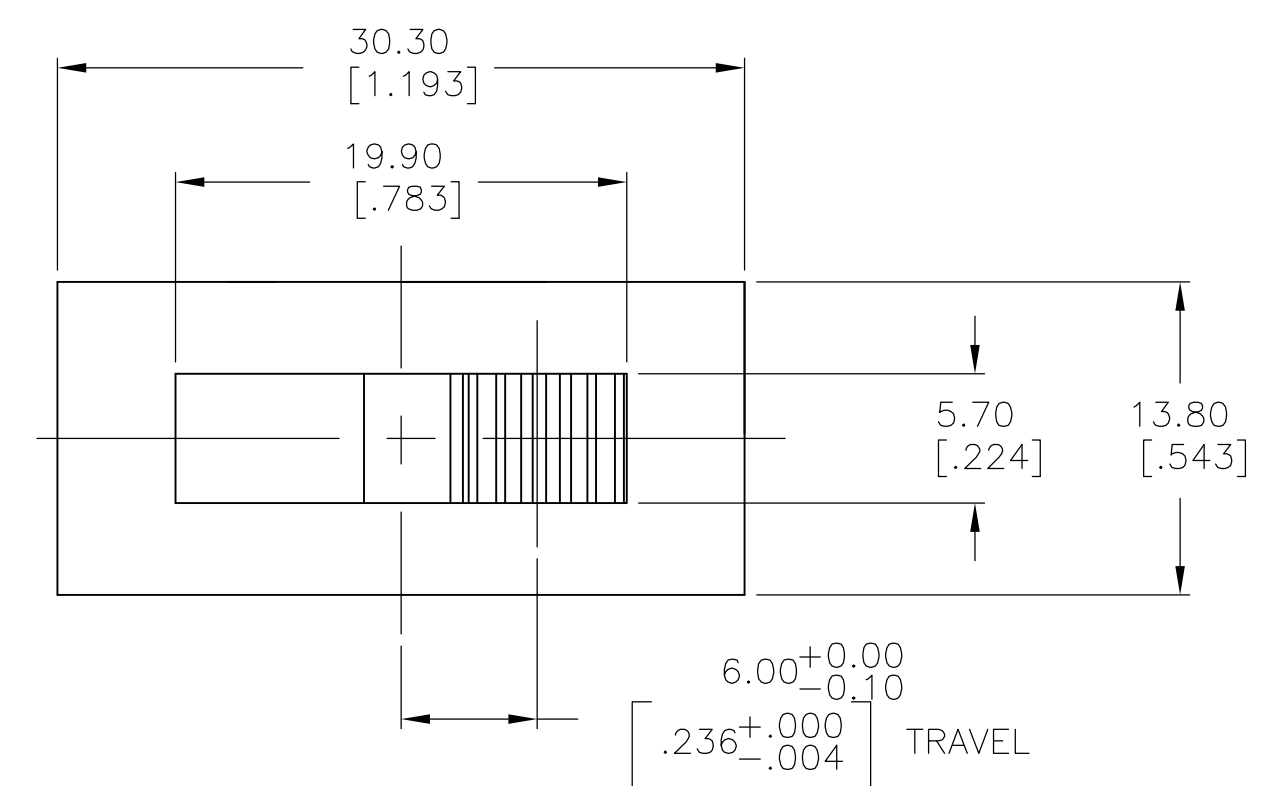

Specifications:
 Double Pole Three Throw
 Break-Before-Make

Materials:
 Actuator, POM, UL94-HB
 Board, Phenolic Laminated Sheet, UL94-HB
 Frame, Steel, Nickel plate
 Terminal, Copper Alloy, Silver over Nickel plate
 Ball, Steel
 Coil Spring, Spring Wire, Black
 Contact Clip, Copper Alloy, Silver plate
 Seal, Epoxy
 Overlay, Polycarbonate UL94V-0, Black

Electrical:
 Max Contact Rating, .5A @ 50V DC max, Per EIA-448, Method 6
 Min Contact rating 1milliamp @ 5V DC min
 Initial Contact resistance, 30 milliohms max, Per EIA-364-23B, each position
 Insulation Resistance, 500 Megohm @ 500V DC, Per EIA-364-21C each position
 Dielectric strength, 500 V AC, Per EIA-364-20B, Condition 1, each position.

Mechanical:
 Actuation force, 400+/-200 GF
 Actuation Travel, 6.00mm
 Life Expectancy, 10,000 cycles, Per EIA-448, Method 8 and 9
 Vibration, Per EIA 364-28, Condition VII, Level E
 Mechanical Shock, Per EIA-364-27, Condition A

Environmental:
 Operating Temperature, -20 to +65 degrees C, Per EIA 448, Method 10
 Storage Temperature, -25 to +70 degrees C
 Humidity and Temperature Cycling Per EIA-364-31B, Method III
 Temperature Life Per EIA-364-17B, Method B, Temperature Test Condition 3, Time Condition B
 Thermal Shock, Per EIA-364-32C, -25 to 70 degrees C
 Solderability, Per EIA-364-52, Class 2, Category 1, 95% Minimum coverage
 Resistance to Solder Heat, Per 109-202, Condition B

- 1 COUNTRY OF ORIGIN AND TE LOGO LOCATED APPROXIMATELY AS SHOWN
- 2 ALL MATERIALS AND FINISHES SHALL COMPLY WITH EU DIRECTIVE 2002/95/EC OF 27JAN2003 (ROHS)
- 3 ANTI SOLDER WICK SEAL AT TERMINAL TO BOARD INTERFACE.
- 4 6.35 MAX PERMISSIBLE BOW ALLOWED, BUT MUST BE ASSEMBLED WITH CONCAVE SIDE OF BOW TOWARD SWITCH.
- 5 PERFORMANCE TESTING TO BE IN ACCORDANCE WITH 102-2469 SPECIFICATION.

1-2, 5-6	2-3, 6-7	2-4, 6-8	1825379-1
			Part Number
TERMINALS CONNECTED WHEN SLIDE IS IN POSITION SHOWN.			

THIS DRAWING IS A CONTROLLED DOCUMENT.		DIN M BINNER 30AUG05	Tyco Electronics Corporation Harrisburg, PA 17105-3608	
DIMENSIONS: mm [INCHES]		CHK M SARVER 30AUG05	NAME SLIDE SWITCH, 0.5 AMP	
TOLERANCES UNLESS OTHERWISE SPECIFIED:		APPD M SARVER 30AUG05	SIZE CAGE CODE DRAWING NO. RESTRICTED TO	
0 PLC ± -	1 PLC ± -	PRODUCT SPEC	A1 00779C=1825379	
2 PLC ± 0.30[0.012]	3 PLC ± -	APPLICATION SPEC	SCALE 3:1 SHEET 1 OF 1 REV B1	
4 PLC ± -	ANGLES ± -	WEIGHT	CUSTOMER DRAWING	

单击下面可查看定价，库存，交付和生命周期等信息

[>>TE Connectivity\(泰科\)](#)