

THIS DRAWING IS UNPUBLISHED. RELEASED FOR PUBLICATION AUG 2006.  
 © COPYRIGHT 2009 BY TYCO ELECTRONICS CORPORATION. ALL RIGHTS RESERVED.

LOC	DIST	REVISIONS			
P	LTR	DESCRIPTION	DATE	DWN	APVD
DW	-	A1	REVISED (ECO-16-002887)	03APR2016	J.J W.H

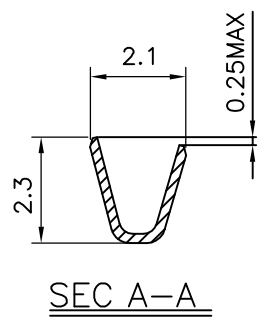
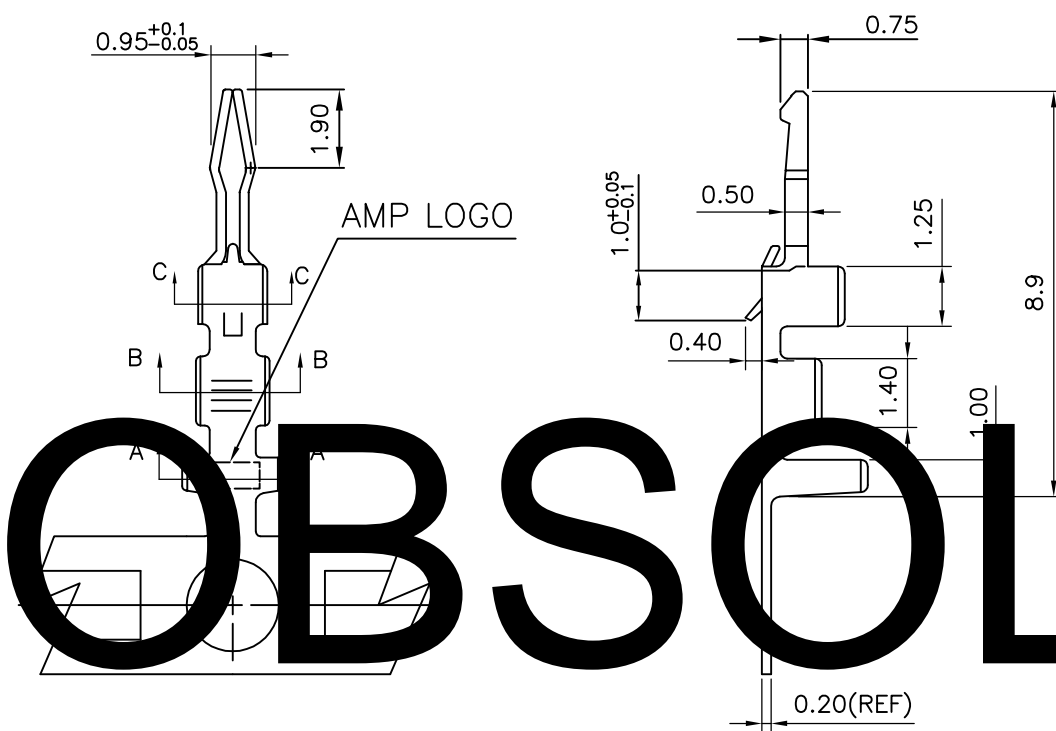

SEC A-A

# OBSOLETE

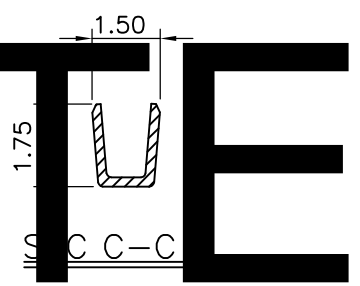

SEC C-C

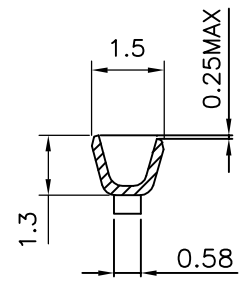

SEC B-B

- NOTE:
- MATERIAL :  
TERMINAL: BRASS.
  - FINISHED :  
TERMINAL: 1.27um [50u"] MIN. TIN ON SOLDER TAILS,  
0.381um [15u"] MIN. NICKEL UNDERPLATED  
ALL OVER.
  - ACCEPTS HOUSING: X-1470201-X.

1470202-1  
PART NUMBER

THIS DRAWING IS A CONTROLLED DOCUMENT.		DWN J. LAI 27MAY2009	Tyco Electronics Corporation Taipei, Taiwan	
DIMENSIONS: MM		CHK S. CHIEN 27MAY2009	NAME	
TOLERANCES UNLESS OTHERWISE SPECIFIED:		APVD W. KODAMA 27MAY2009	2.0 MM PITCH, CRIMP, VERTICAL, CONTACT.	
0 PLC ± -		PRODUCT SPEC	SIZE	
1 PLC ± 0.20		108-57158	CAGE CODE	
2 PLC ± 0.10		APPLICATION SPEC	DRAWING NO	
3 PLC ± 0.05		501-57248	RESTRICTED TO	
4 PLC ± -		WEIGHT	-	
ANGLES ± -		- GRAMS	A3 00779 C=1470202	
MATERIAL	FINISH	CUSTOMER DRAWING		SCALE
SEE NOTE	SEE NOTE	SHEET		1 OF 2
		REV		A1

4

3

2

1

THIS DRAWING IS UNPUBLISHED. RELEASED FOR PUBLICATION AUG 2006.  
 © COPYRIGHT 2009 BY TYCO ELECTRONICS CORPORATION. ALL RIGHTS RESERVED.

LOC	DIST	REVISIONS			
P	LTR	DESCRIPTION	DATE	DWN	APVD
		SEE SHEET 1.			

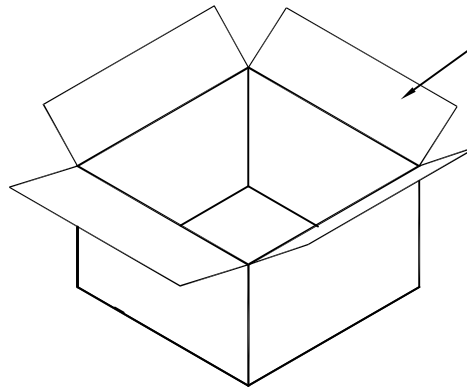

CARTON  
 590mm(L)X590mm(W)X115mm(H)  
 40,000 TERMINALS / CARTON

# OBSOLETE

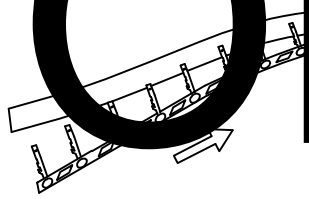

REEL  
 DIAMETER:  $\phi$ 580mm.  
 10,000 TERMINALS / REEL

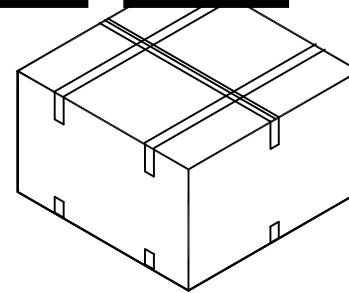

THIS DRAWING IS A CONTROLLED DOCUMENT.		DWN	Tyco Electronics Corporation Taipei, Taiwan	
DIMENSIONS: MM		CHK	NAME	
TOLERANCES UNLESS OTHERWISE SPECIFIED:		APVD	2.0 MM PITCH, CRIMP, VERTICAL, CONTACT.	
0 PLC ± -		PRODUCT SPEC	SIZE	CAGE CODE
1 PLC ± -		APPLICATION SPEC	A3	00779
2 PLC ± -		WEIGHT	DRAWING NO	
3 PLC ± -		CUSTOMER DRAWING	G=1470202	
4 PLC ± -		SCALE	SHEET	REV
ANGLES ± -			2 of 2	A1
MATERIAL	FINISH	RESTRICTED TO		

单击下面可查看定价，库存，交付和生命周期等信息

[>>TE Connectivity\(泰科\)](#)