

THIS DRAWING IS UNPUBLISHED. RELEASED FOR PUBLICATION
 © COPYRIGHT - By - ALL RIGHTS RESERVED.

REVISIONS					
P	LTR	DESCRIPTION	DATE	OWN	APVD
	A2	KEYING POSITION CORRECTED IN ZONE A4 & A3	27FEB2017	TJ	NG

NOTES:

- ELECTRICAL DATA: CONTACT RESISTANCE: 10 mOhm MAX
 INSULATION RESISTANCE: 100 MOhm MIN at 500VDC
 CURRENT RATING: 5 AMPS (FOR 3, 4 AND 5 POSITIONS) AND 2 AMPS (FOR 8 POSITIONS)
 BREAKDOWN VOLTAGE: 500 VAC MIN PER MINUTE
- ENVIRONMENTAL: OPERATING TEMPERATURE: -25°C TO +90°C
 SEALING REQUIREMENTS: IP67
- PACKAGING: 107-3334
- SEAL FOR CABLE OD: ϕ 4.5mm - ϕ 6.5mm
- FOR TECHNICAL DATA REFER TO YOUR LOCAL TE CONNECTIVITY SALES OFFICE.
- ALL DIMENSIONS ARE FOR NOMINAL REFERENCE ONLY UNLESS OTHERWISE STATED.

ITEM	DESCRIPTION	MATERIAL	FINISH/COLOUR	QUANTITY / ITEM		
				-1	-2	-3
1	CONNECTOR HOUSING	GF NYLON	BLACK	1	1	1
2	GASKET	SILICONE	BLACK	1	1	1
3	CONNECTOR BODY	GF NYLON	BLACK	1	1	1
4	SEALING NUT	GF NYLON	BLACK	1	1	1
5	SEAL	EPDM	BLACK	1	1	1
6	PIN CONTACT	BRASS	0.15 μ m GOLD OVER NICKEL	3	4	5
7	SCREW NUT	GF NYLON	BLACK	1	1	1

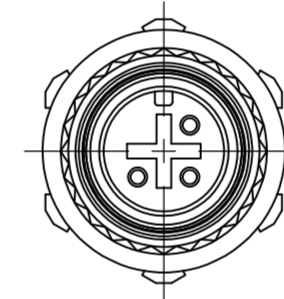
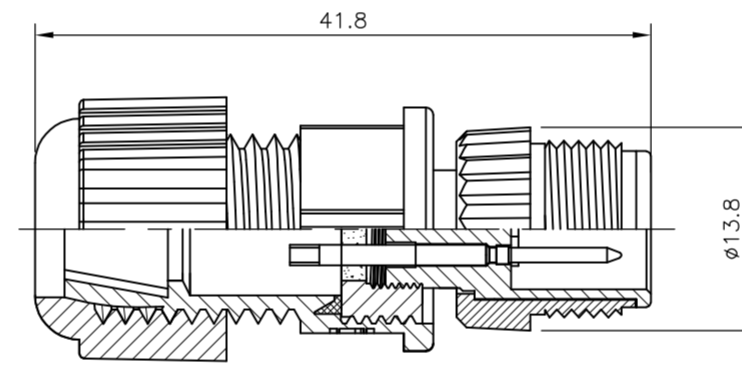
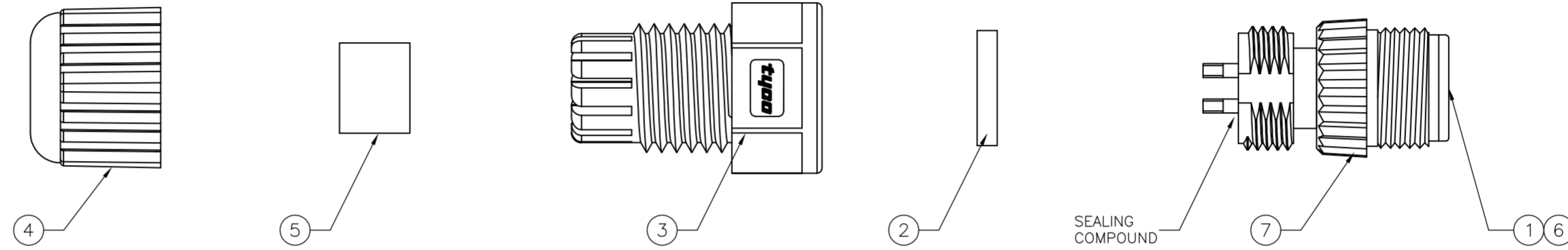

1838277-1
PIN ASSIGNMENTS
FRONT VIEW

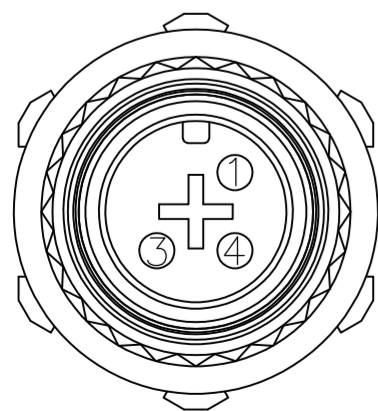

1838277-2
PIN ASSIGNMENTS
FRONT VIEW

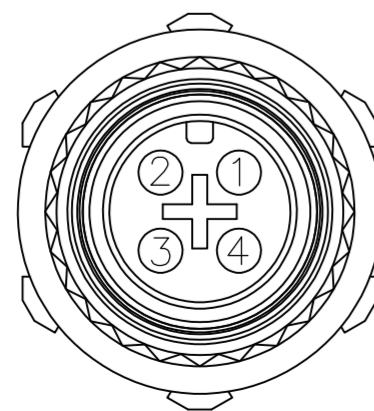

1838277-3
PIN ASSIGNMENTS
FRONT VIEW

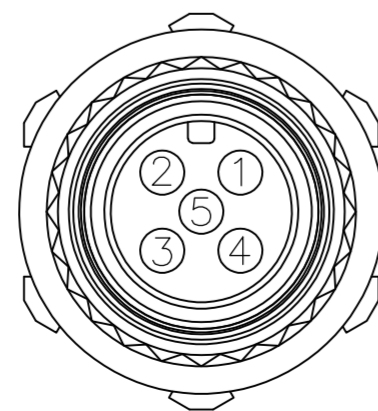

1838277-4
PIN ASSIGNMENTS
FRONT VIEW

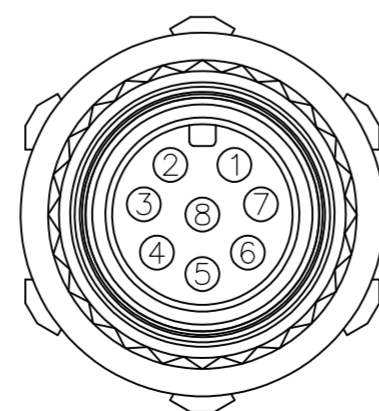

M12 PLASTIC FIELD SERVICEABLE CONNECTOR, MALE PIN, SOLDER TYPE	8	1838277-4
M12 PLASTIC FIELD SERVICEABLE CONNECTOR, MALE PIN, SOLDER TYPE	5	1838277-3
M12 PLASTIC FIELD SERVICEABLE CONNECTOR, MALE PIN, SOLDER TYPE	4	1838277-2
M12 PLASTIC FIELD SERVICEABLE CONNECTOR, MALE PIN, SOLDER TYPE	3	1838277-1
DESCRIPTION	NO. OF POS	PART NUMBER

THIS DRAWING IS A CONTROLLED DOCUMENT.		DWN A.Morey 14MAR06	TE Connectivity	
DIMENSIONS: mm		CHK F.Wheeler-King 12APR06	NAME F.Wheeler-King 12APR06	
		APVD F.Wheeler-King 12APR06		PRODUCT SPEC
MATERIAL REFER BOM TABLE		FINISH REFER BOM TABLE		APPLICATION SPEC
WEIGHT 0		SIZE A2		RESTRICTED TO
CUSTOMER DRAWING		DRAWING NO 00779		REV A2
SCALE NTS		SHEET 1 OF 1		

单击下面可查看定价，库存，交付和生命周期等信息

[>>TE Connectivity\(泰科\)](#)