

THIS DRAWING IS UNPUBLISHED.
 RELEASED FOR PUBLICATION
 © Copyright - TE Connectivity ALL RIGHTS RESERVED.

REVISIONS				
P	LW	DESCRIPTION	DATE	BY / APPR
B1		REVISED PER ECR-17-013047	12SEP2017	J.Z. D.Z.

- PARTS MUST COMPLY WITH AMP SOLDERABILITY SPECIFICATION 109-11-3.
- WIRE RANGE: 0.8 - 2.0 mm² [18 - 14 AWG].
- INSULATION RANGE: 2.29 - 3.81 [.090 - .150] DIAMETER
- FITS A 1.57 [.062] THICK P.C. BOARD.

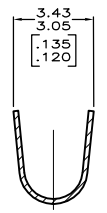
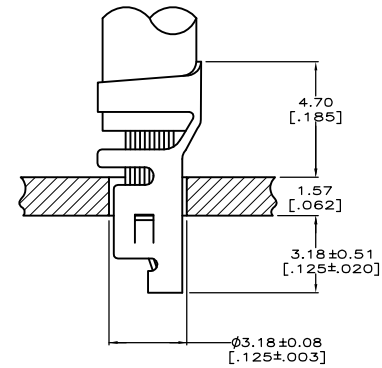
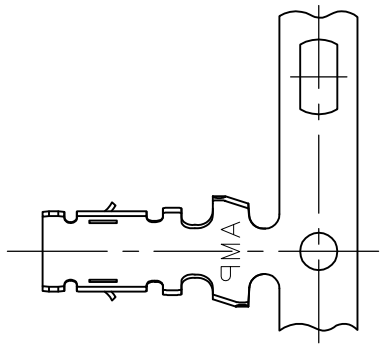

SECTION A-A

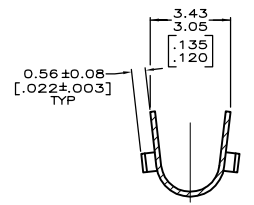

SECTION B-B

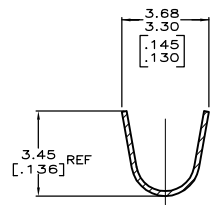
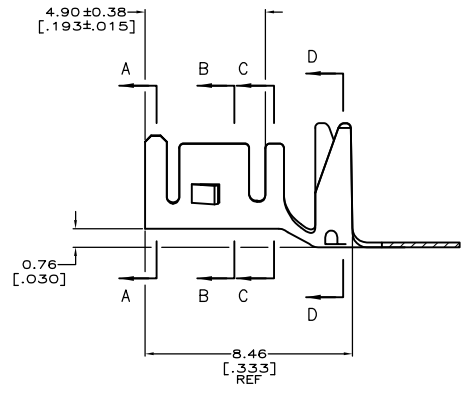

SECTION C-C

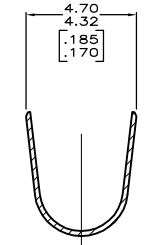

SECTION D-D

YES	0.00508	[.000200]	BRIGHT TIN	0.198	[.0078]	PH BRZ	3-647334-1
NO	0.00508	[.000200]	BRIGHT TIN-LEAD	0.198	[.0078]	PH BRZ	647334-1
LEAD FREE	FINISH			MATERIAL		PART NUMBER	

METRIC

THIS DRAWING IS A CONTROLLED DOCUMENT.

APPROVED BY: X. WHITAKER 130072004	DATE: 130072004	TE TE Connectivity
DESIGNED BY: J. ELLIS 130072004	DATE: 130072004	
PRODUCT SPEC: J. ELLIS 130072004	APPLICATION SPEC: J. ELLIS 130072004	TERMINAL, MINI AMP-IN™ 2000
MATERIAL: SEE TABLE	FINISH: SEE TABLE	WEIGHT: 0.000000
CUSTOMER DRAWING		SIZE: A1 CASE CODE: 00779C PART NUMBER: 647334

SCALE: 10:1 SHEET 1 OF 1 REV B1

单击下面可查看定价，库存，交付和生命周期等信息

[>>TE Connectivity\(泰科\)](#)