



698-960, 1710-2700 & 3400-3800 MHz LTE

Standard Antenna Solutions

2G, 3G, 4G, 5G, NB-IoT, Cat-M, World Band, WLAN 2.4 GHz; Bluetooth, ZigBee

Part Number: 2195771-1

PRODUCT FACTS:

- Omnidirectional in all frequencies
- External ceiling mount antenna
- Customizable cable and connector
- UV resistant
- IP rating: IP65
- Low PIM
- RoHS compliant

SPECIFICATIONS:

- Frequency Range:
 - 698-960 MHz; 1710-2700 MHz; 3400-3800 MHz
- Peak Gain:
 - 698-960 MHz: typ. 3.2 dBi
 - 1710-1920 MHz: typ. 5.9 dBi
 - 2170-2700 MHz: typ. 7.0 dBi
 - 3400-3800 MHz: typ. 5.5 dBi
- VSWR:
 - 698-960 MHz: < 1.4
 - 1710-2700 MHz: < 1.5
 - 3400-3800 MHz: < 2.2
- PIM ≤ -150dBc @ 2 x 43 dBm
- Azimuth Beam Width: Omni directional
- Feed Point Impedance: 50 ohms
- Power Handling: 150 Watt cw
- Size: ø 185 x H 90 (mm)
- Weight: 0.25 Kg
- Mounting: Ceiling/support mount
- Connector: N female or 4.3/10 female
- Operating Temperature: -30° to 75°C

VSWR:

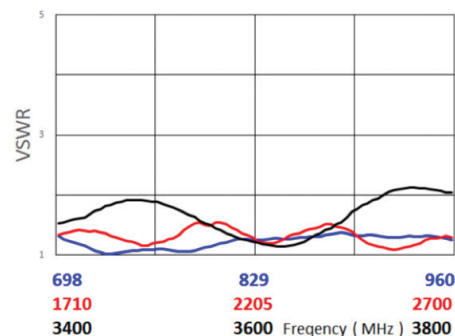

RETURN LOSS:

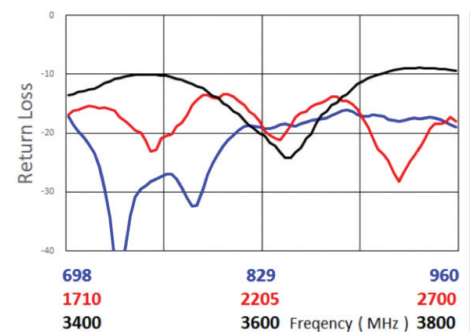

EFFICIENCY:

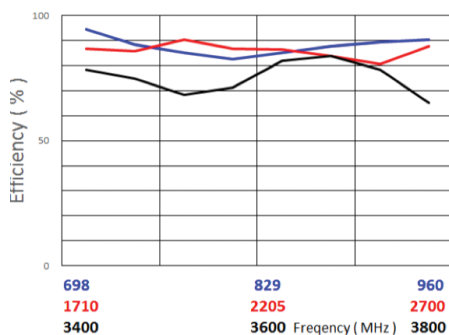

TEST ORIENTATION IN FREE SPACE:

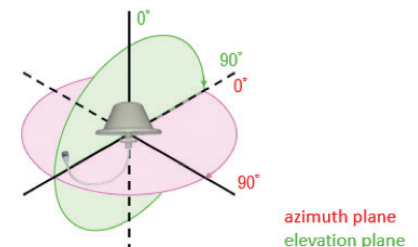

AZIMUTH:

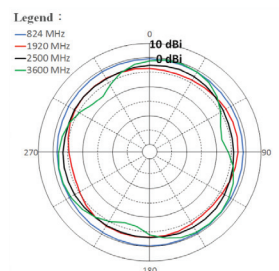

ELEVATION:

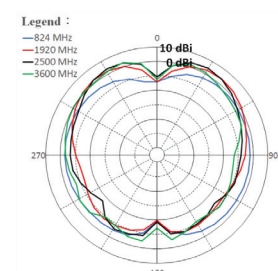

698-960, 1710-2700 & 3400-3800 MHz LTE ANTENNA

Standard Antenna Solutions

DIMENSIONS:

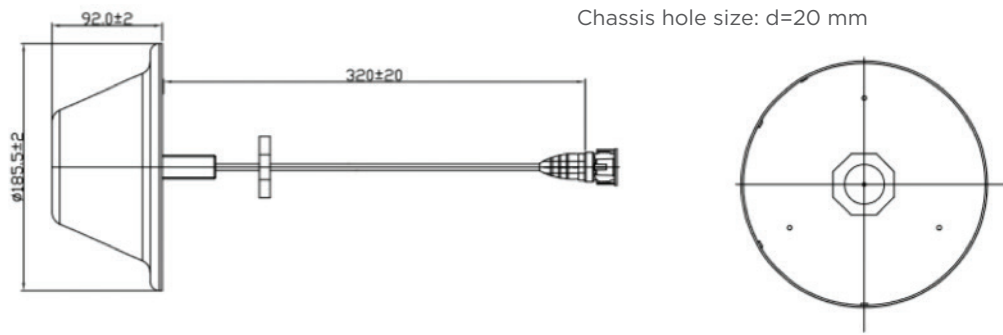

TE TECHNICAL SUPPORT CENTER

USA:	+1 (800) 522-6752
Canada:	+1 (905) 475-6222
Mexico:	+52 (0) 55-1106-0800
Latin/S. America	+54 (0) 11-4733-2200
Germany:	+49 (0) 6251-133-1999
UK:	+44 (0) 800-267666
France:	+33 (0) 1-3420-8686
Netherlands:	+31 (0) 73-6246-999
China:	+86 (0) 400-820-6015

For phone numbers in other countries, go to te.com/support-center

te.com

TE Connectivity, TE Connectivity (logo) and Every Connection Counts are trademarks. All other logos, products and/or company names referred to herein might be trademarks of their respective owners.

The information given herein, including drawings, illustrations and schematics which are intended for illustration purposes only, is believed to be reliable. However, TE Connectivity makes no warranties as to its accuracy or completeness and disclaims any liability in connection with its use. TE Connectivity's obligations shall only be as set forth in TE Connectivity's Standard Terms and Conditions of Sale for this product and in no case will TE Connectivity be liable for any incidental, indirect or consequential damages arising out of the sale, resale, use or misuse of the product. Users of TE Connectivity products should make their own evaluation to determine the suitability of each such product for the specific application.

© 2019 TE Connectivity Ltd. family of companies All Rights Reserved.

1-1773975-7 06/19 Original

单击下面可查看定价，库存，交付和生命周期等信息

[>>TE Connectivity\(泰科\)](#)