

LOC		DIST		REVISIONS			
P	LTR	DESCRIPTION	DATE	DMN	APVD		
U3		REVISED PER ECR-17-006277	25MAY2017	BW	KR		

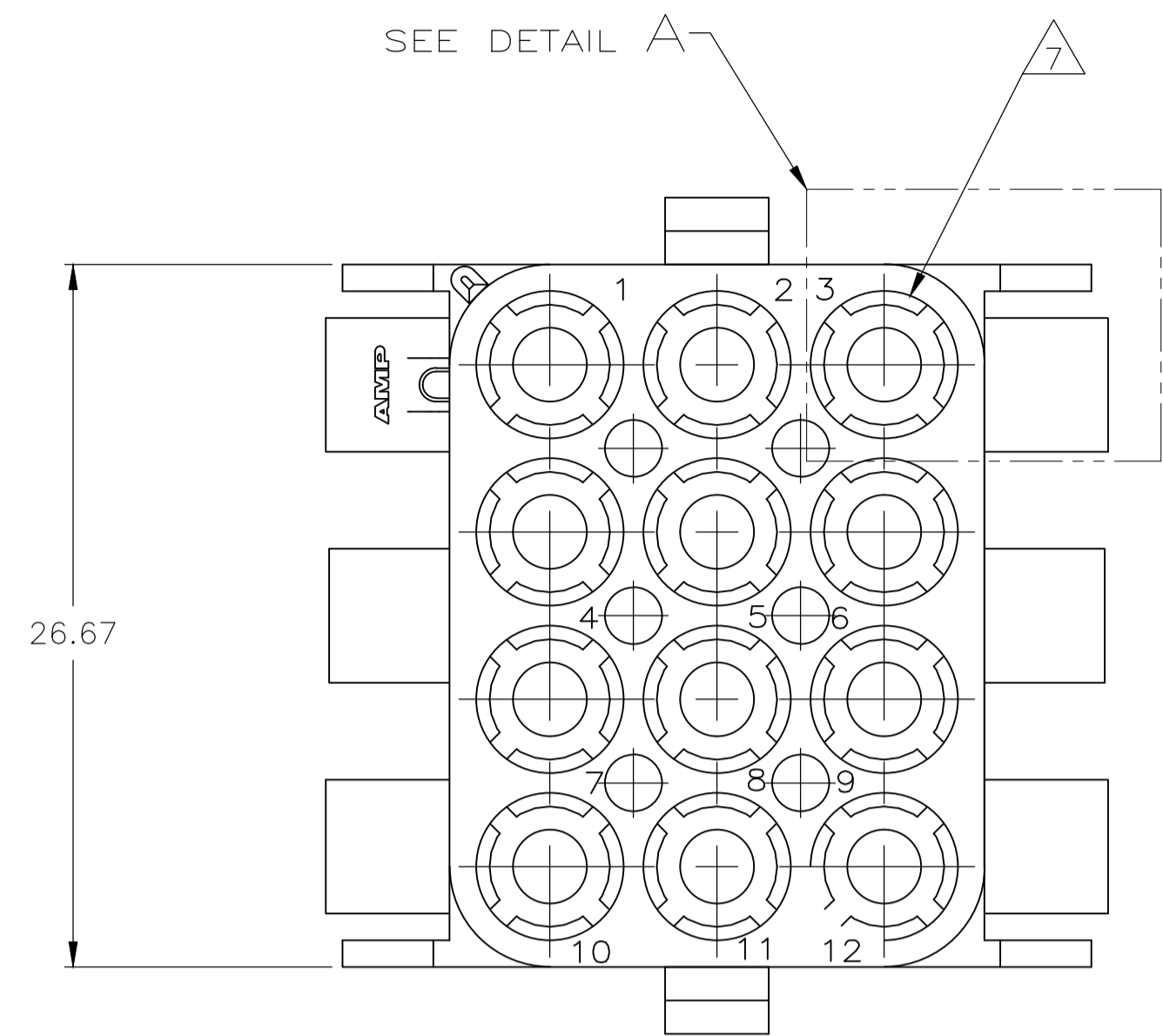

1. MATES WITH APPROPRIATE UNIVERSAL MATE-N-LOK™ PLUG.
2. RECOMMENDED PANEL THICKNESS 0.76 - 2.29.
3. PANEL MUST BE PUNCHED SO THAT THE HOUSING ENTERS THE PANEL IN THE SAME DIRECTION AS THE PUNCH.
4. OPTIONAL FOR KEYING HOUSING IN PANEL.
5. CIRCUIT NUMBER 1 LOCATION.
6. DIMENSIONS SHOWN REPRESENT PRODUCT IN DRY, AS MOLDED, CONDITION. ADDITIONAL 2% GROWTH DUE TO SUBSEQUENT MOISTURE ABSORPTION MAY OCCUR AND SHOULD BE ACCOUNTED FOR.
7. FOUR RIBS EQUALLY SPACED, NO SPECIFIC ORIENTATION. NO RIBS OR SIX RIBS EQUALLY SPACED, NO SPECIFIC ORIENTATION, OPTIONAL.
8. UNDERWRITERS RECOGNIZED COMPONENT LOGO AND CSA CERTIFICATION LOGO TO BE LOCATED ONCE EACH ON SIDE OF HOUSING.

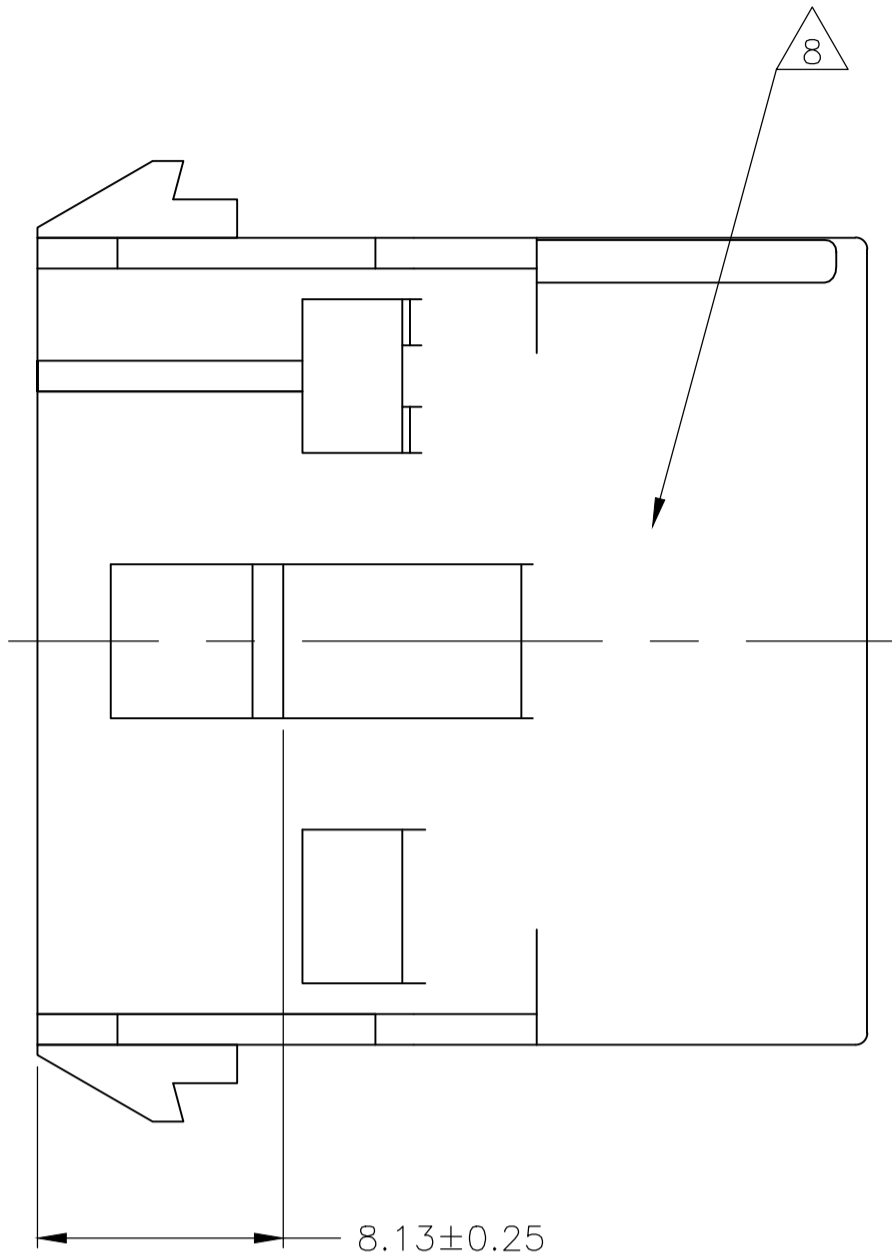
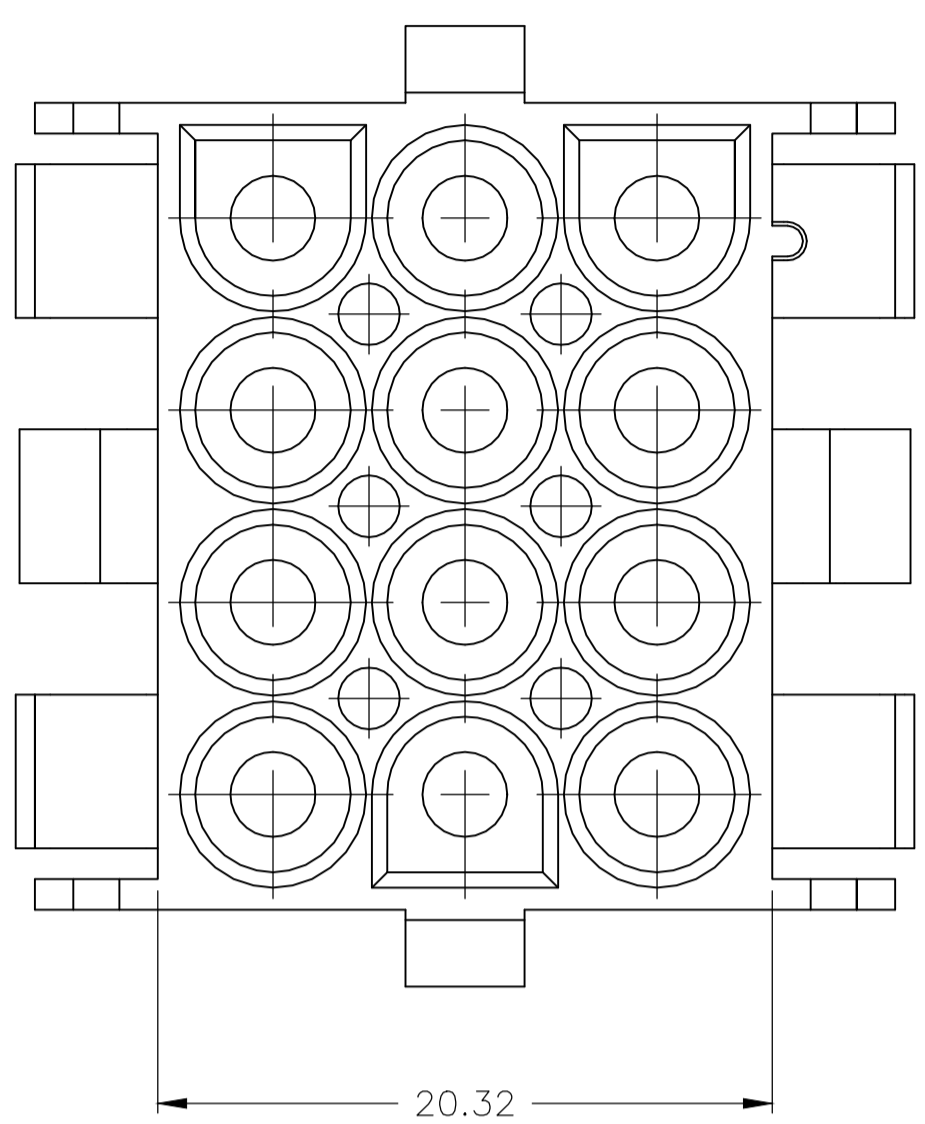
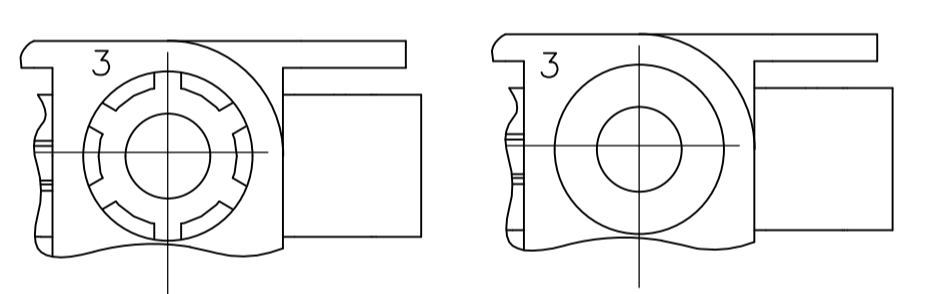

DETAIL A
OPTIONAL CONSTRUCTION

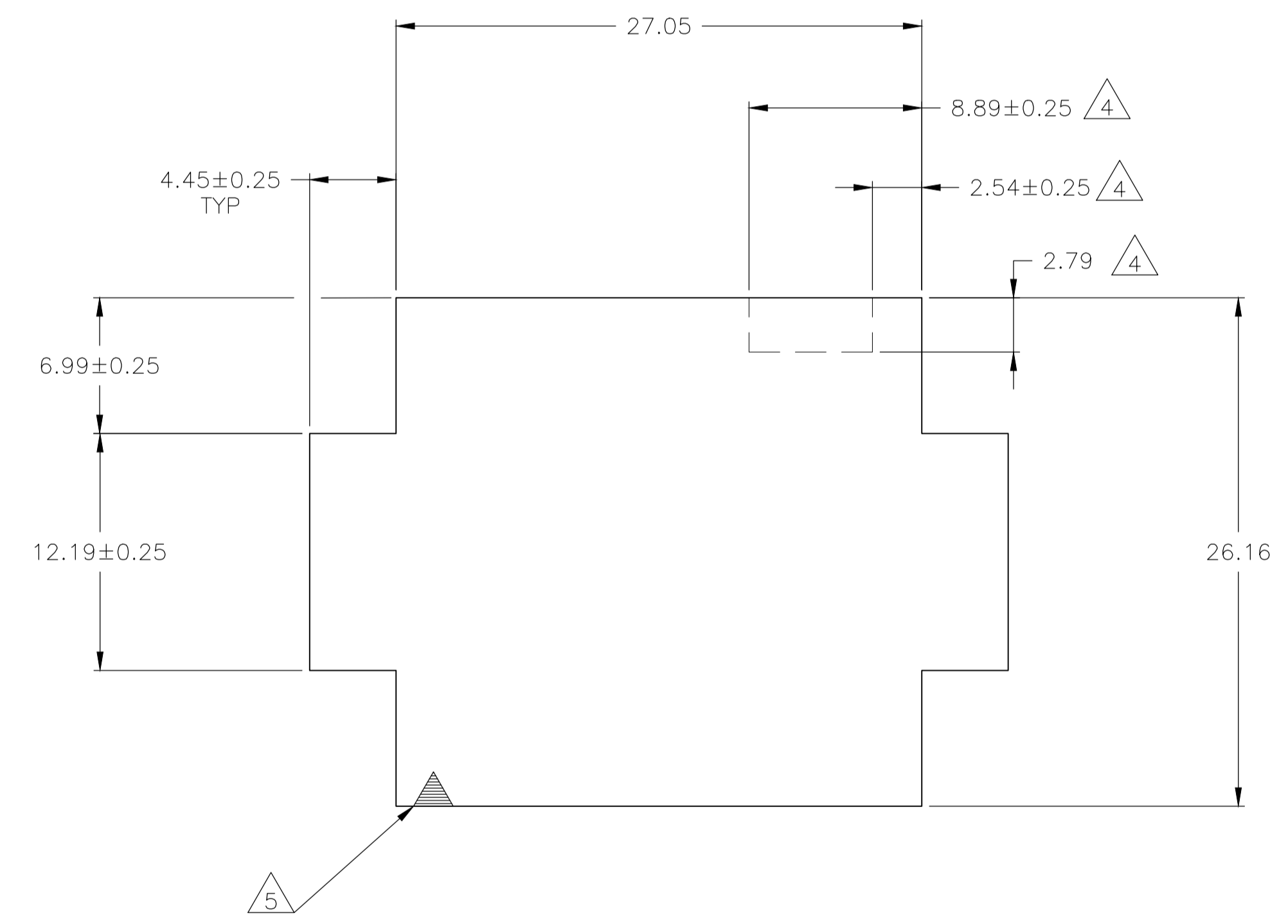
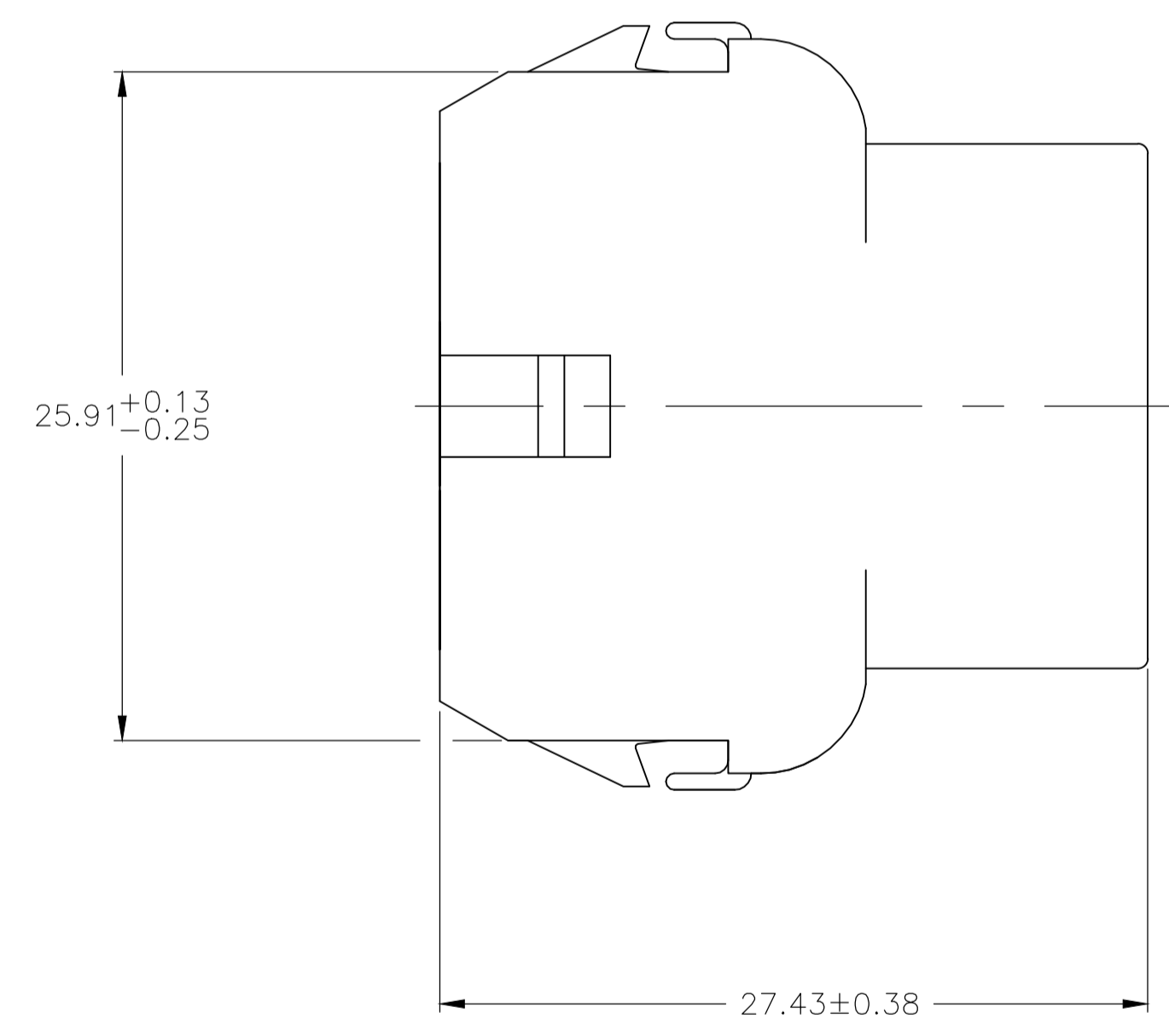

RECOMMENDED PANEL CUT OUT

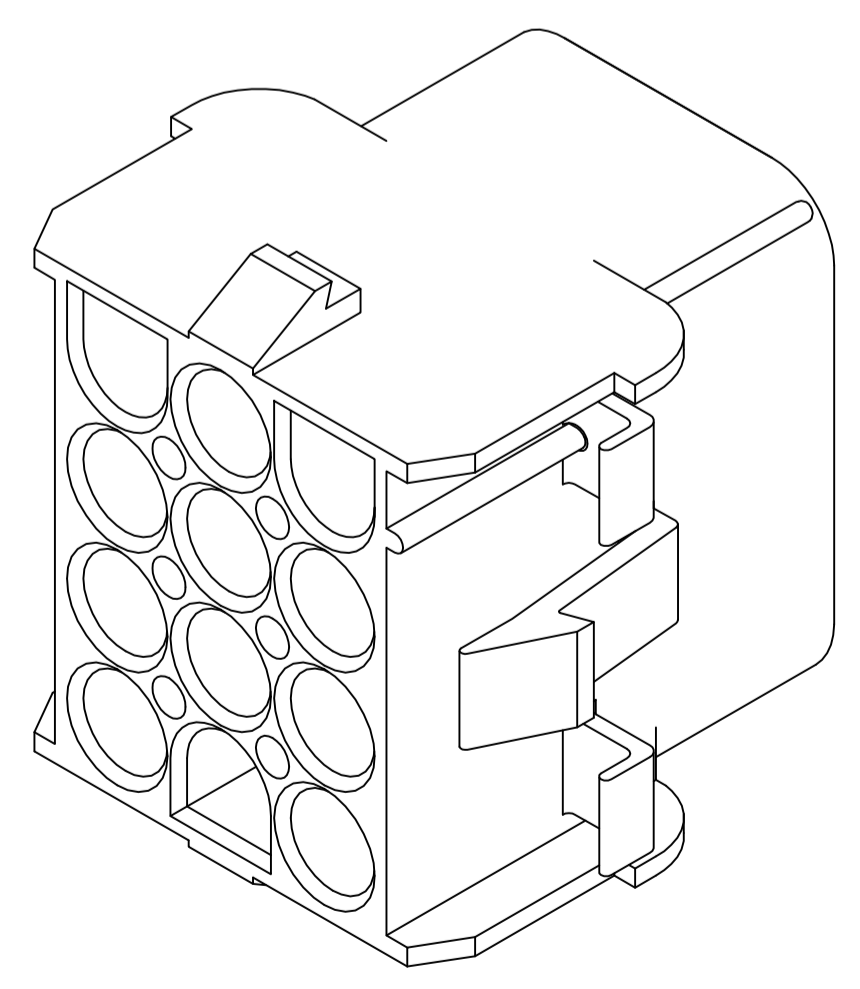

3-DIMENSIONAL MODEL
NTS

6.99	.275	27.43	1.080
4.45	.175	27.05	1.065
2.79	.110	26.67	1.050
2.54	.100	26.16	1.030
2.29	.090	25.91	1.020
0.76	.030	20.32	.800
0.38	.015	12.19	.480
0.25	.010	8.89	.350
0.13	.005	8.13	.320
MM	IN	MM	IN

CONVERSION TABLE

BLACK	1-350783-9
GRAY	1-350783-8
BLUE	1-350783-6
GREEN	1-350783-5
YELLOW	1-350783-4
ORANGE	1-350783-3
RED	1-350783-2
BROWN	1-350783-1
NATURAL	350783-1
COLOR	PART NO.

THIS DRAWING IS A CONTROLLED DOCUMENT.

DIMENSIONS:	TOLERANCES UNLESS OTHERWISE SPECIFIED:	DIN K. WHITAKER 28MAY92	CHK R. SWING 28MAY92	APVD D. SELF 02JUN92	NAME
mm	0. PLC ± - 1. PLC ± - 2. PLC ± 0.13 3. PLC ± - 4. PLC ± - ANGLES ± 1°	NYLON,UL 94V-0	FINISH -	WEIGHT -	APPLICATION SPEC
MATERIAL		SIZE		CAGE CODE	DRAWING NO
		A1		00779	350783
CUSTOMER DRAWING		SCALE		SHEET	REV
		4:1		1 of 1	U3

STE TE Connectivity

CAP.12 CIRCUIT, UNIVERSAL MATE-N-LOK™

单击下面可查看定价，库存，交付和生命周期等信息

[>>TE Connectivity\(泰科\)](#)