

LOC	DIST	REVISIONS					
GP	00	P	LTN	DESCRIPTION	DATE	DWN	APVD
		A		REVISED PER ECO-12-018201	17OCT2012	KH	MH

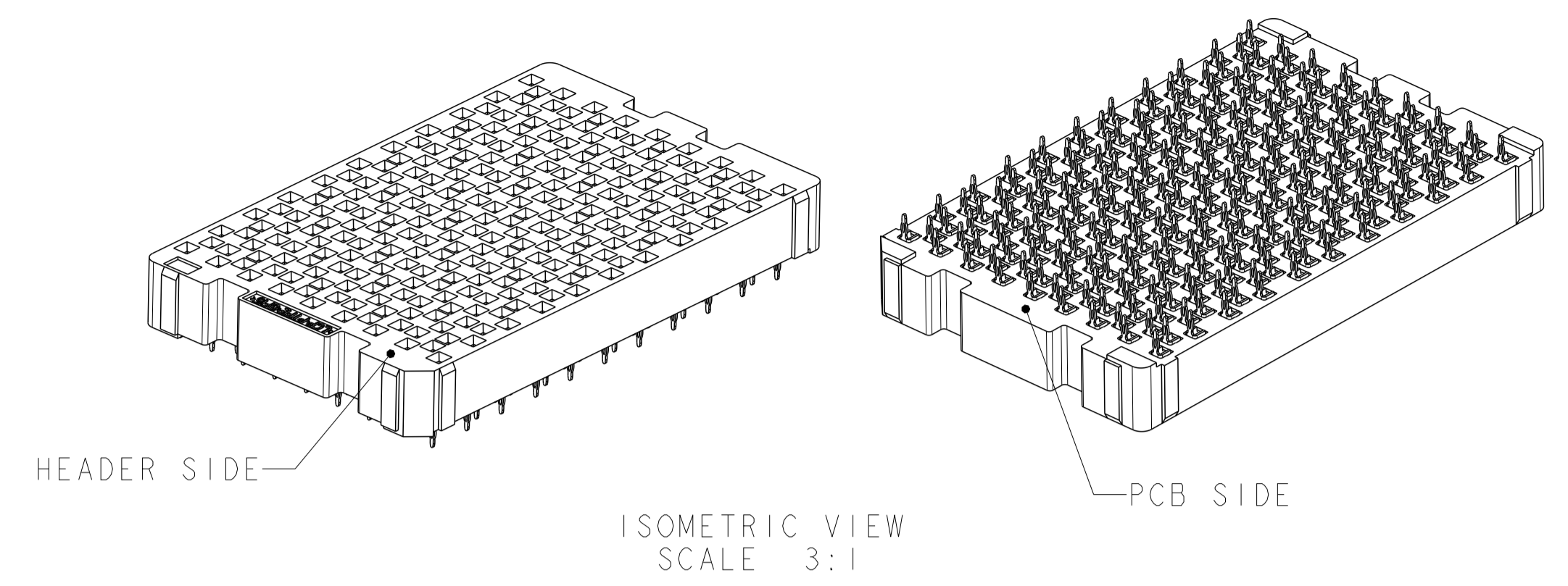

- 1 MATERIAL:  
HOUSING: THERMOPLASTIC, FLAMMABILITY RATING UL94-VO  
CONTACT: COPPER ALLOY
- 2 CONTACT PLATING: 0.076µm MIN GOLD OVER 0.69µm MIN PALLADIUM NICKEL, OVER 2.54-5.08µm NICKEL ON MATING AREA. 0.50-2.54µm 93/7 TIN-LEAD, OVER 1.27-5.08µm NICKEL ON TAIL AREA. PORE BLOCKER APPLIED TO MATING AREA.
- 3 CONTACT PLATING: 0.076µm MIN GOLD OVER 0.69µm MIN PALLADIUM NICKEL, OVER 2.54-5.08µm NICKEL ON MATING AREA. 0.50-2.54µm MATTE TIN, OVER 1.27-5.08µm NICKEL ON TAIL AREA. PORE BLOCKER APPLIED TO MATING AREA.
- 4 ROWS GA THRU GJ (SHOWN DARKENED) ARE TYPICALLY USED AS GROUNDS.
- 5 SPECIFIED POSITIONAL TOLERANCE DEFINES HOLE TO HOLE LOCATION WITHIN HOLE PATTERN. POSITIONAL TOLERANCE OF HOLE PATTERN TO FIDUCIAL MARKS OR PCB DATUMS SHALL BE DEFINED BY CUSTOMER.
- 6 AREA RESERVED FOR TE CONNECTIVITY LOGO.
- 7 AREA RESERVED FOR PART NUMBER (X-XXXXXXX-X) AND DATE CODE (YYWW).
- 8 USE CENTERLINES INDICATED ON PCB HOLE PATTERN TO ESTABLISH ALIGNMENT BETWEEN HEADER AND RECEPTACLE BOARDS.
- 9 PLATED THROUGH HOLE REQUIREMENTS:  
HOLE SIZE PRIOR TO PLATING =  $\varnothing 0.420 \pm 0.013$   
COPPER PLATING THICKNESS =  $0.038 \pm 0.013$   
CALCULATED FINISHED HOLE SIZE =  $\varnothing 0.344 \pm 0.039$   
THESE DIMENSIONS APPLY TO THE TOP 1.25mm OF THE PCB THICKNESS FROM THE CONNECTOR MOUNTING SIDE.

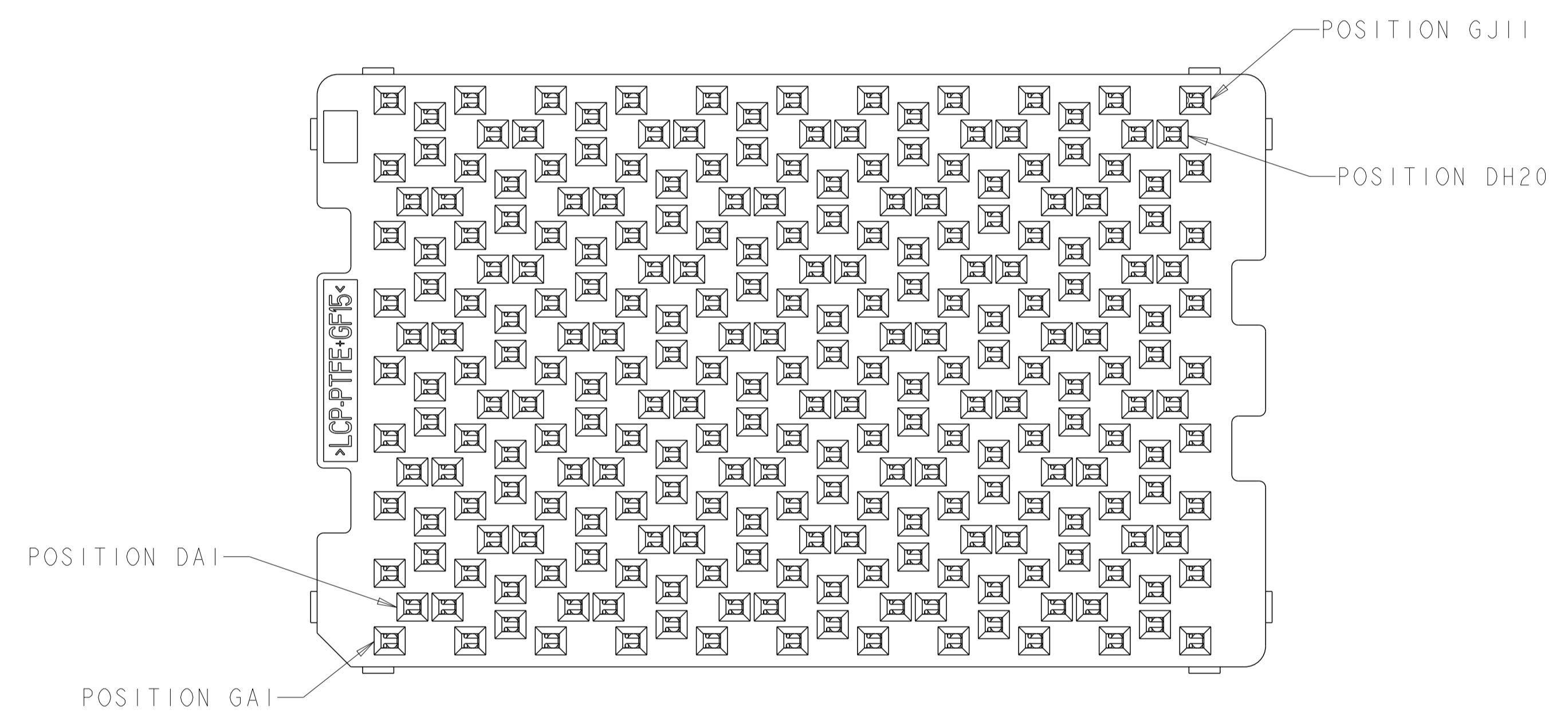

**SIZE 2 HOUSING \***  
**80 DIFFERENTIAL PAIRS**  
**259 TOTAL SIGNAL CONTACTS**

\* SIZE 1 AND SIZE 3 ARE ALSO AVAILABLE

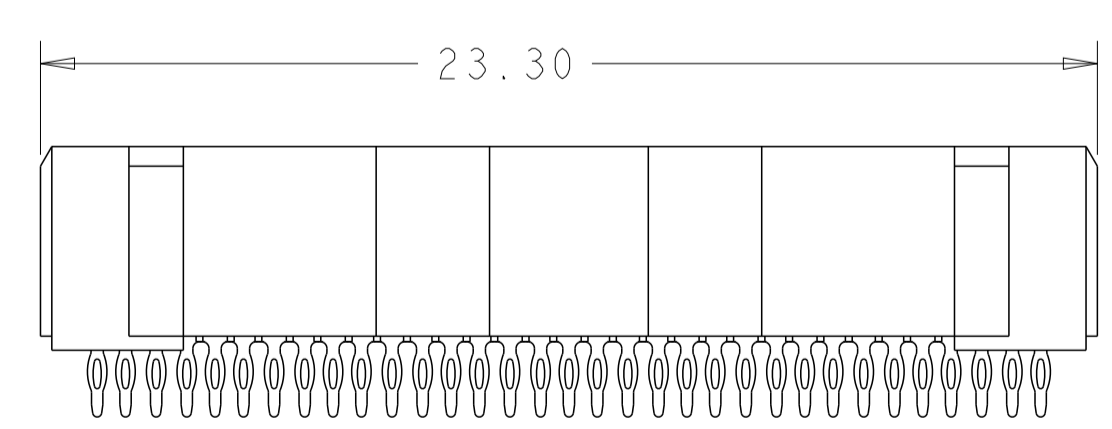
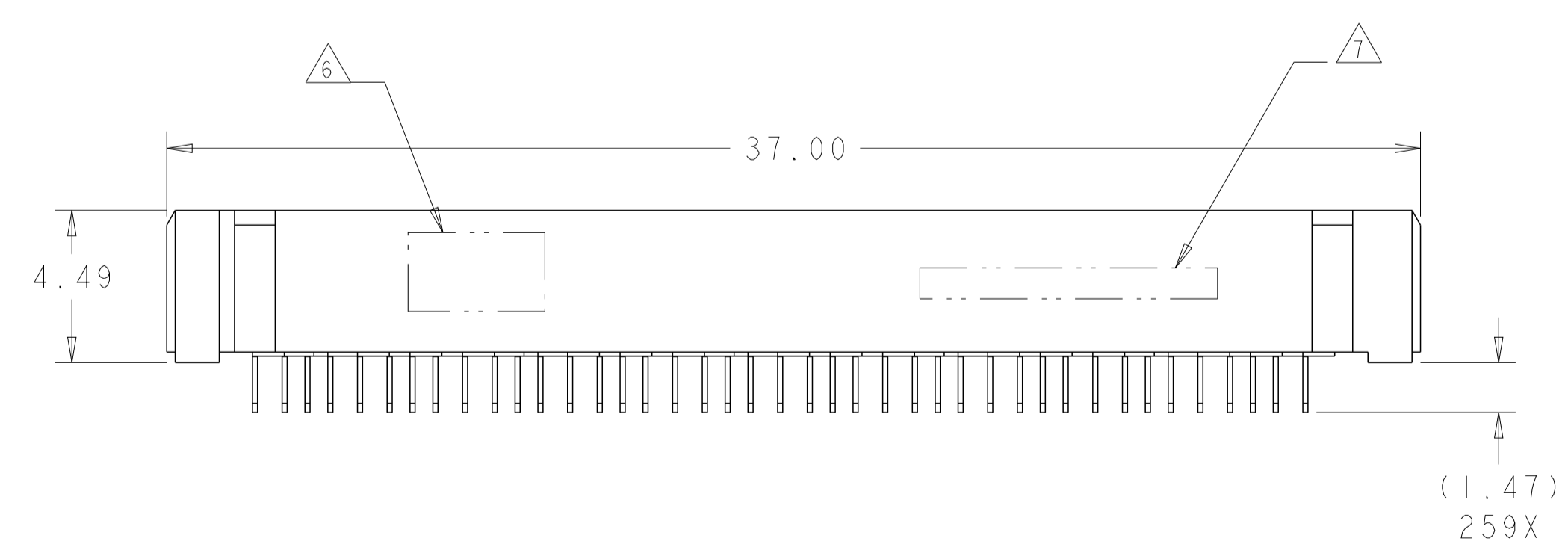

FINISH		TOOLED	CONTACT TAIL PLATING	PART NUMBER
YES		MATTE Sn	5-2057361-1	
		Sn/Pb	2057361-1	
MATERIAL		Customer Drawing	SCALE 6:1	SHEET 1 OF 3
DIMENSIONS: mm 0 PLC ± 1 PLC ±0.13 2 PLC ±0.13 3 PLC ±0.13 4 PLC ± ANGLES ±1 FINISH		TOLERANCES UNLESS OTHERWISE SPECIFIED: APVD J.FEDDER 03SEP2008 PRODUCT SPEC 108-2375 APPLICATION SPEC 114-13249 WEIGHT	NAME RECEPTACLE ASSEMBLY 80/259 SIGNAL STRADA MESA MEZZANINE CONNECTOR SIZE CAGE CODE DRAWING NO RESTRICTED TO A100779C=2057361 SCALE 6:1 SHEET 1 OF 3 REV A	

LOC	DIST	REVISIONS			
P	LTN	DESCRIPTION	DATE	DMN	APVD
-	-	SEE SHEET 1	-	-	-

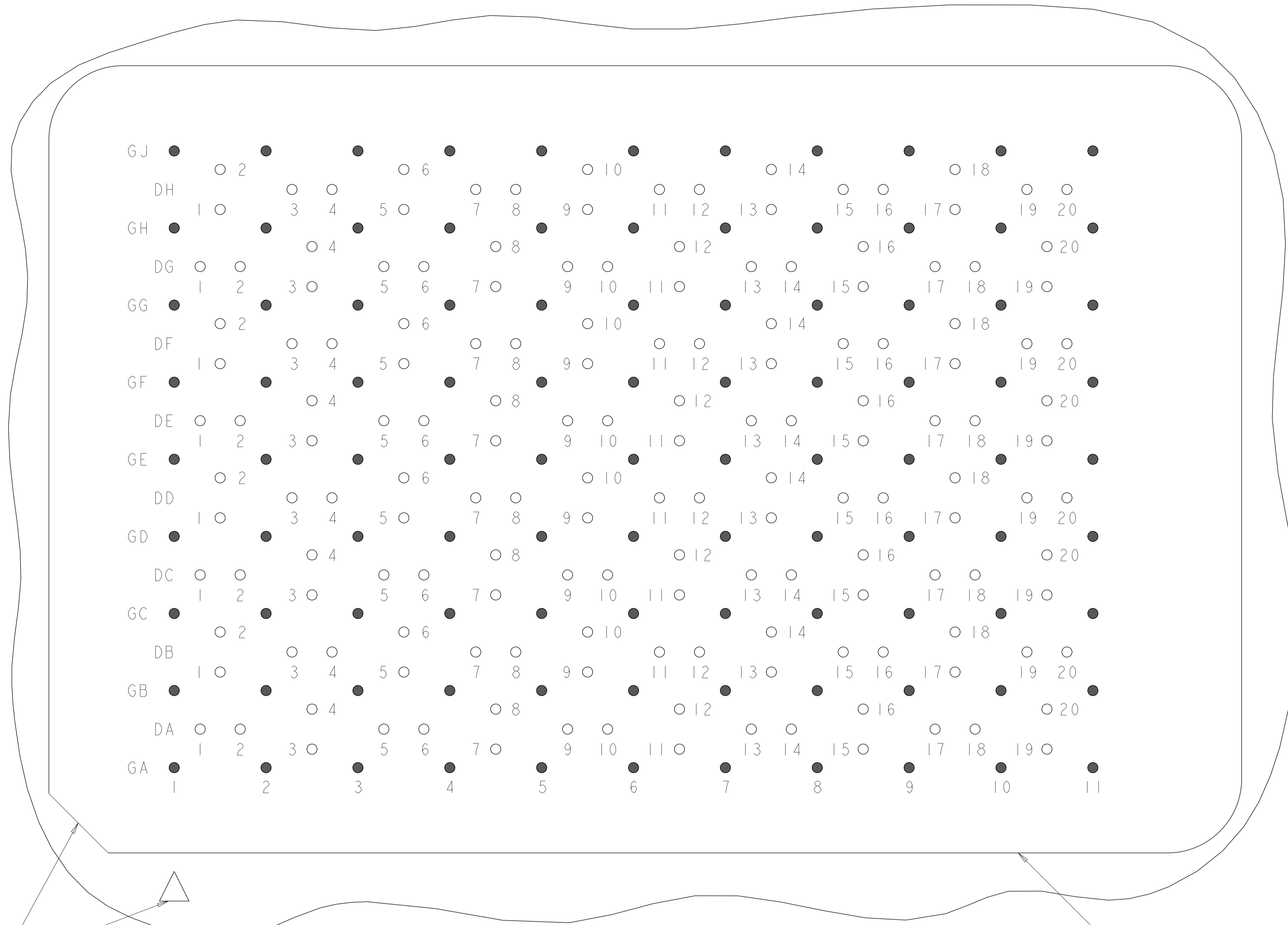

A1 CORNER INDICATORS.

MATED CONNECTOR OUTLINE SEE SHEET 3 FOR LOCATION TO HOLES

**PCB LAYOUT AND PIN IDENTIFICATION**   
 SHOWN FROM CONNECTOR SIDE  
 SCALE 12:1

THIS DRAWING IS A CONTROLLED DOCUMENT.		DMN D. RINGLER 03SEP2008	 TE Connectivity
DIMENSIONS:		CHK D. TROUT 03SEP2008	
mm	TOLERANCES UNLESS OTHERWISE SPECIFIED:	APVD J. FEEDER 03SEP2008	NAME RECEPTACLE ASSEMBLY
0 PLC ±	1 PLC ±.13	PRODUCT SPEC	80/259 SIGNAL
2 PLC ±.013	3 PLC ±.013	APPLICATION SPEC	STRADA MESA MEZZANINE CONNECTOR
4 PLC ±	ANGLES ±.1	SIZE CAGE CODE DRAWING NO	RESTRICTED TO
MATERIAL	FINISH	114-13249	A100779C=2057361
Customer Drawing		WEIGHT	SCALE 6:1 SHEET 2 OF 3 REV A

LOC		DIST		REVISIONS			
GP	00	P	LYR	DESCRIPTION	DATE	OWN	APVD
-	-	-	-	SEE SHEET 1	-	-	-
-	-	-	-	-	-	-	-
-	-	-	-	-	-	-	-

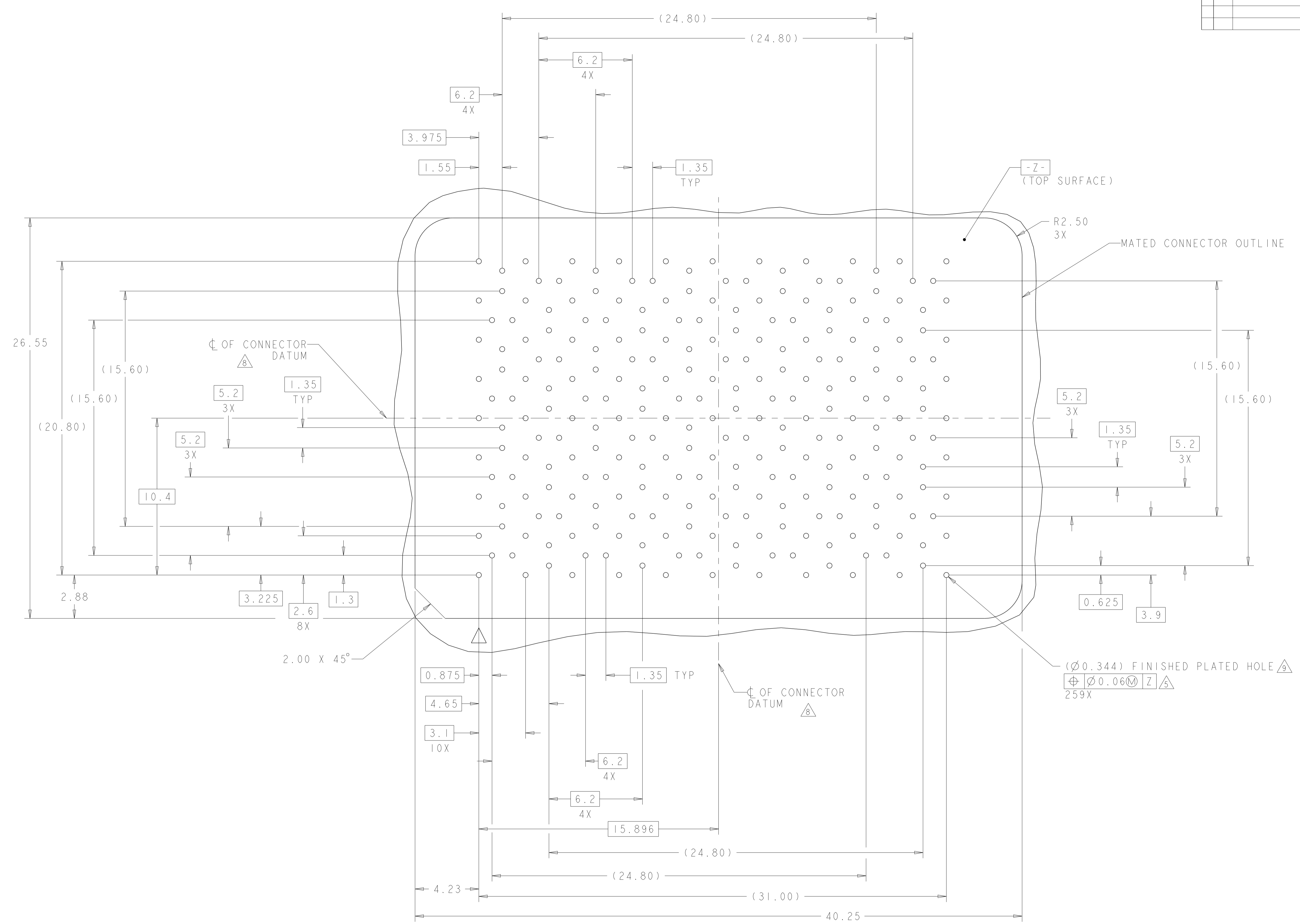

**PCB HOLE PATTERN**  
 SHOWN FROM CONNECTOR SIDE  
 SCALE 8:1

THIS DRAWING IS A CONTROLLED DOCUMENT.		OWN	D. RINGLER	03SEP2008	TE Connectivity RECEPTACLE ASSEMBLY 80/259 SIGNAL STRADA MESA MEZZANINE CONNECTOR
DIMENSIONS:		CHK	D. TROUT	03SEP2008	
mm		APVD	J. FEDDER	03SEP2008	
0 PLC ± 2 PLC ±0.13 3 PLC ±0.013 4 PLC ± ANGLES ±1		PRODUCT SPEC	108-2375	APPLICATION SPEC	
MATERIAL	FINISH	WEIGHT	114-13249	114-13249	RESTRICTED TO
Customer Drawing		SCALE	6:1	SHEET 3 OF 3	REV A

单击下面可查看定价，库存，交付和生命周期等信息

[>>TE Connectivity\(泰科\)](#)