

THIS DRAWING IS UNPUBLISHED. RELEASED FOR PUBLICATION
 © COPYRIGHT - By - ALL RIGHTS RESERVED.

| REVISIONS | | | | | |
|-----------|-----|-------------------------|-----------|-----|------|
| P | LTR | DESCRIPTION | DATE | DWN | APVD |
| | P2 | RELEASED(ECR-18-019397) | 22MAR2019 | J.J | W.H |

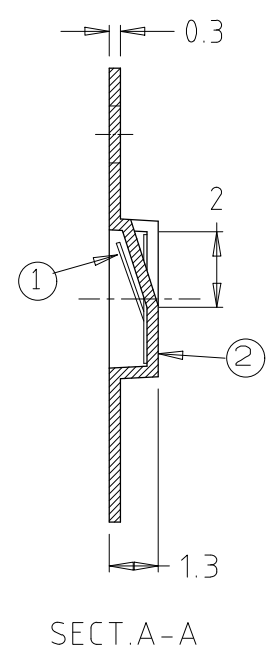
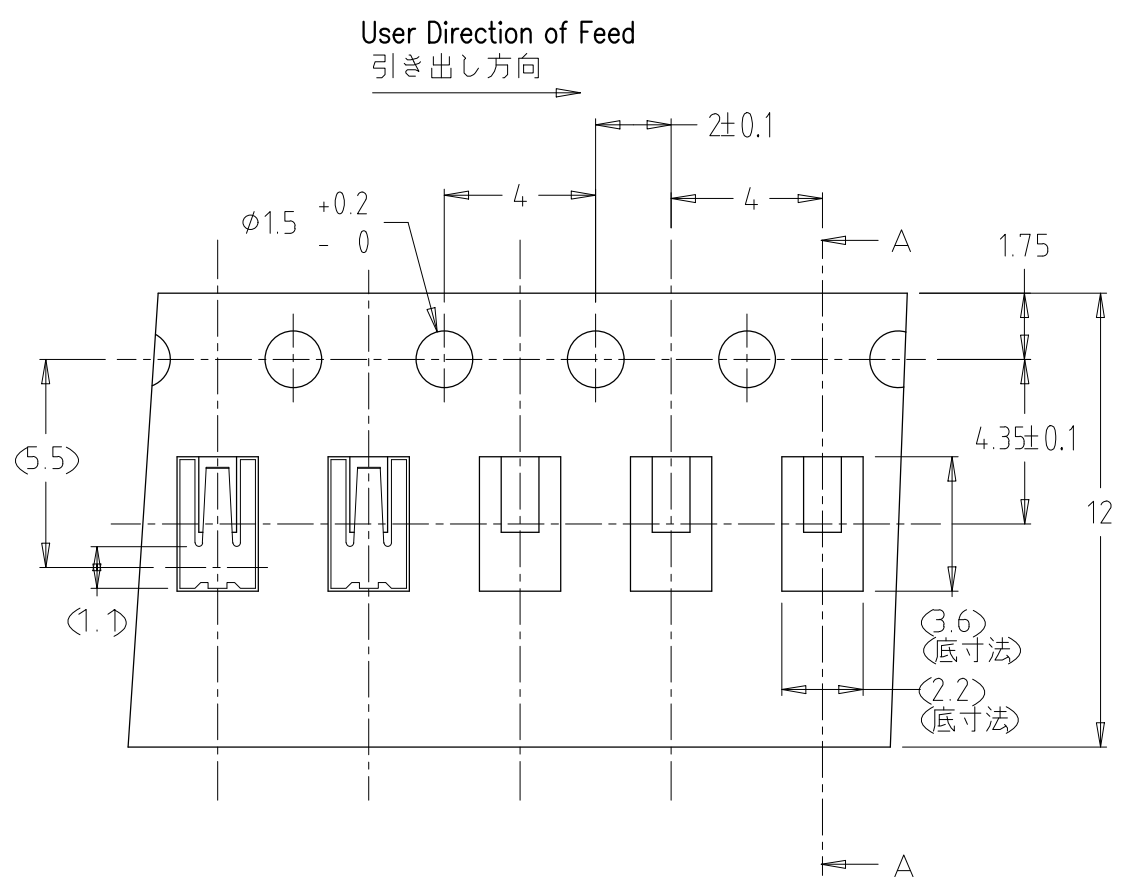

注記
NOTE

1. 一般公差: ± 0.3
1. GENERAL TOLERANCE: ± 0.3
2. 梱包数量: 10,000ケ/リール
2. PACKING STYLE: 10,000pcs/reel
3. 材質:
3. MATERIAL:
シールドフィンガー: 銅合金(ニッケル下地金めっき 0.05 μ mMIN.)
SHIELD FINGER: COPPER ALLOY (GOLD-PLATING 0.05 μ m MIN.)
(SOLDER-PLATING ON THE BOTTOM PLANE ONLY)
キャリアテープ: アクリル系フィルム
CARRIER TAPE: ACRYLIC FILM
カバーテープ: PETフィルム
TOP TAPE: PET FILM
リール: プラリール
REEL: PLASTIC
4. リードテープ長さ: 下図参照
4. TAPES DIMENSION

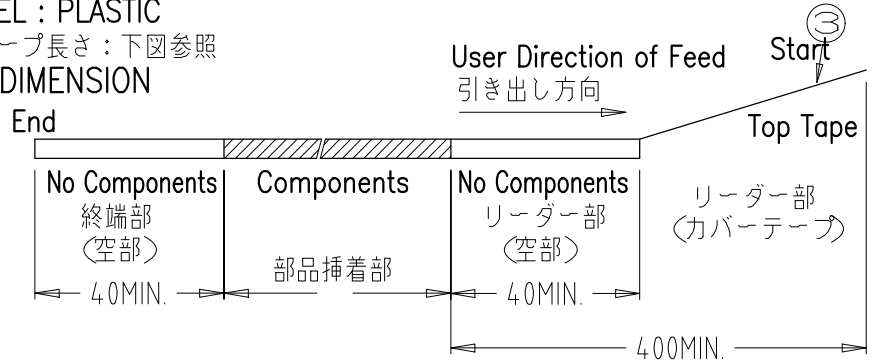

5. リール参考寸法: 下図参照
5. REEL DIMENSION: REFERENCE ONLY

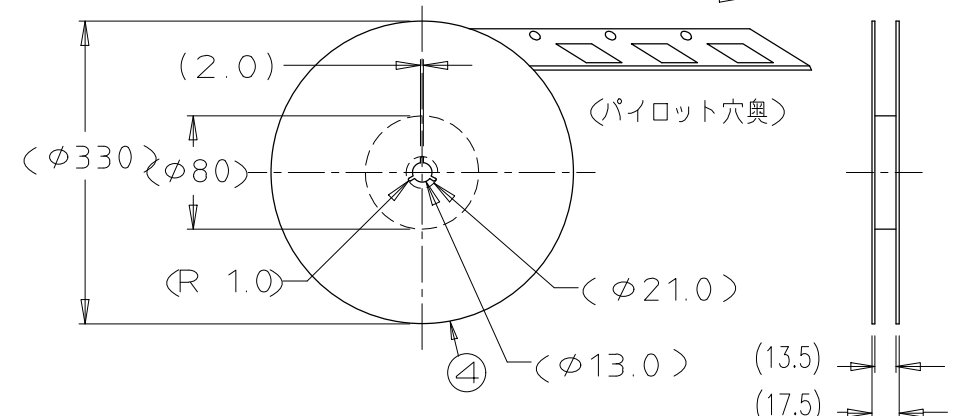

シールドフィンガー0820
SHIELD FINGER 0820

旧型番: 3400089 S=10/1
OLD CAT.NO.340009

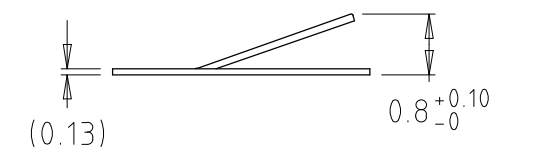
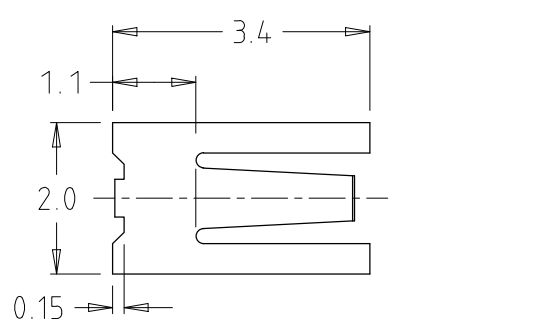

参考パッド寸法 (公差 ± 0.1)
RECOMMENDED FOOT PRINT
REFERENCE ONLY
(GENERAL TOLERANCE: ± 0.1)

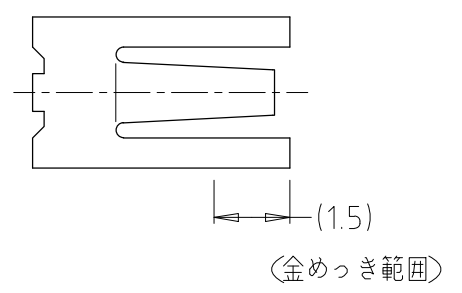
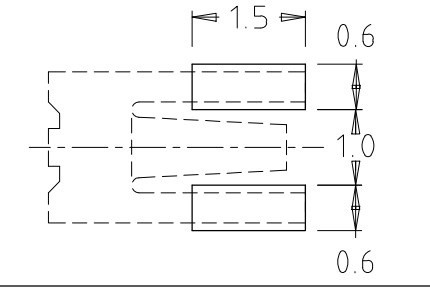

| テピング梱包型番 PACKAGING Cat.No. | 旧テピング梱包型番 PACKAGING Cat.No. | No. | 名称 DESIGNATION | 型番 Cat. No. | 数量 QUANTITY |
|-------------------------------|--------------------------------|-----|----------------------------------|----------------|-------------------|
| 1447009-5 | 3100029 | (4) | リール REEL | (旧型番: 3150008) | 1 |
| | | (3) | カバーテープ | (旧型番: 3150027) | 1 |
| | | (2) | エンボスキャリアテープ CARRIER TAPE | (旧型番: 3150026) | 10000ポケット (部品装着部) |
| | | (1) | シールドフィンガー0820 SHIELD FINGER 0820 | (旧型番: 3400089) | 10000ケ |

| | | | | | |
|--|--|------------------------|---|-----------------|------------------------|
| THIS DRAWING IS A CONTROLLED DOCUMENT. | | DWN (K.TAMURA) 19SEP00 | TE Connectivity | | |
| DIMENSIONS: mm | | CHK T.KUBO 160CT00 | | | |
| TOLERANCES UNLESS OTHERWISE SPECIFIED: | | APVD | NAME | | |
| 0 PLC \pm - | | PRODUCT SPEC | PACKAGING OF SHIELD FINGER 0820 ON CONTINUOUS TAPES | | |
| 1 PLC \pm - | | APPLICATION SPEC | RESTRICTED TO | | |
| 2 PLC \pm - | | WEIGHT 0.000000 | SIZE A3 | CAGE CODE 00779 | DRAWING NO C-1447009-5 |
| 3 PLC \pm - | | CUSTOMER DRAWING | SCALE 5:1 | | SHEET 1 OF 1 |
| 4 PLC \pm - | | | REV P2 | | |
| ANGLES \pm - | | | | | |
| FINISH | | | | | |

单击下面可查看定价，库存，交付和生命周期等信息

[>>TE Connectivity\(泰科\)](#)