

THIS DRAWING IS UNPUBLISHED. RELEASED FOR PUBLICATION
 © COPYRIGHT - BY TYCO ELECTRONICS CORPORATION. ALL RIGHTS RESERVED.

LOC	DIST	REVISIONS					
H	-	P	LTR	DESCRIPTION	DATE	DWN	APVD
		A		DRAWING RELEASED PER ECR-11-017294	22AUG2011	JvdH	TdB

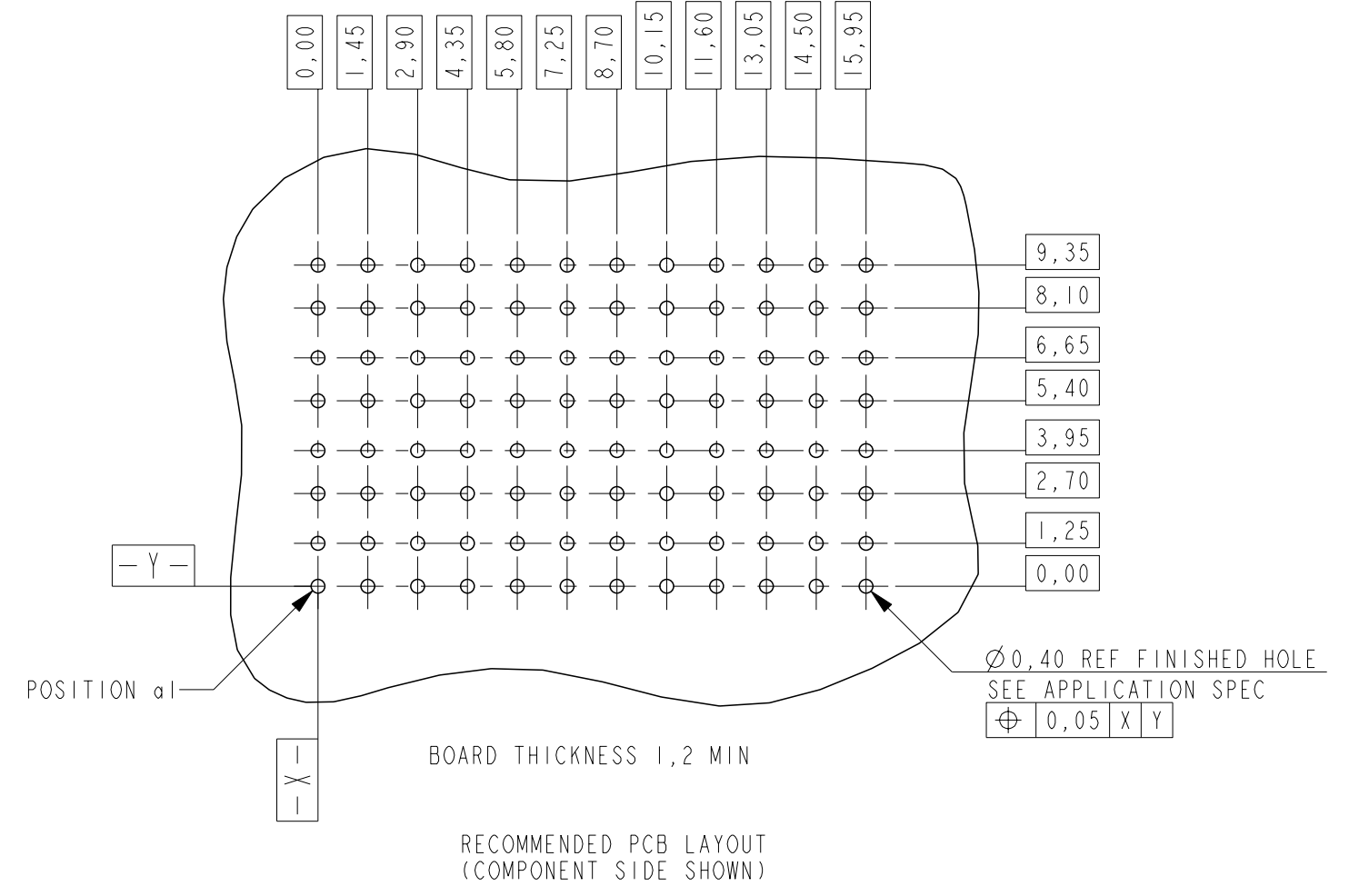
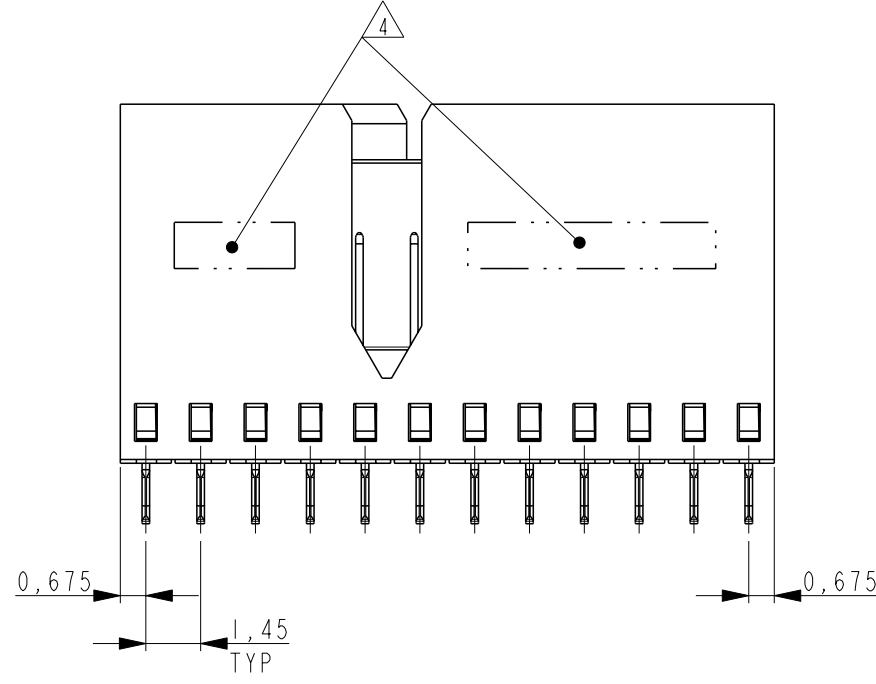
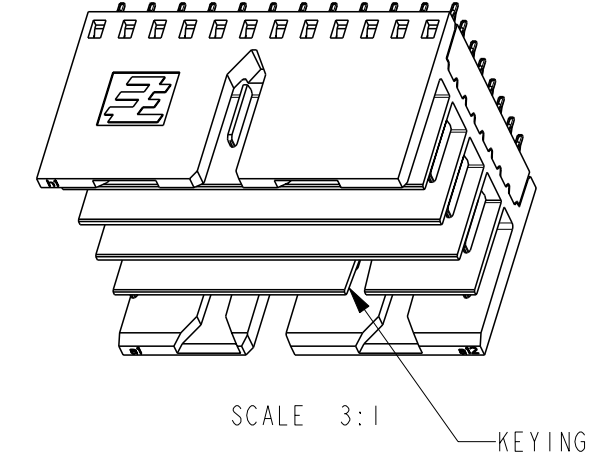
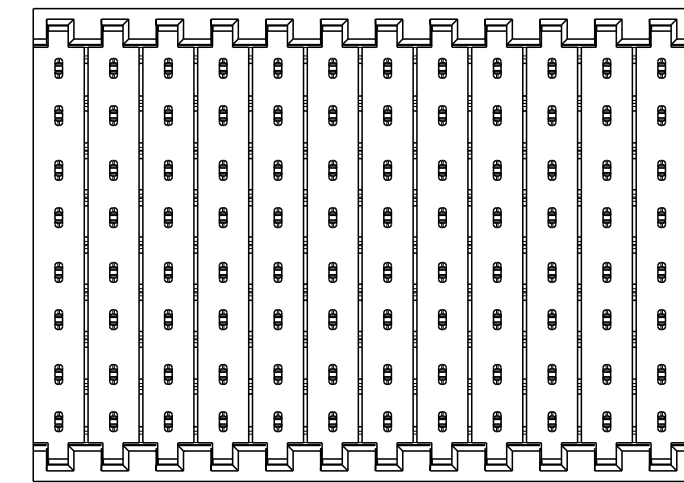
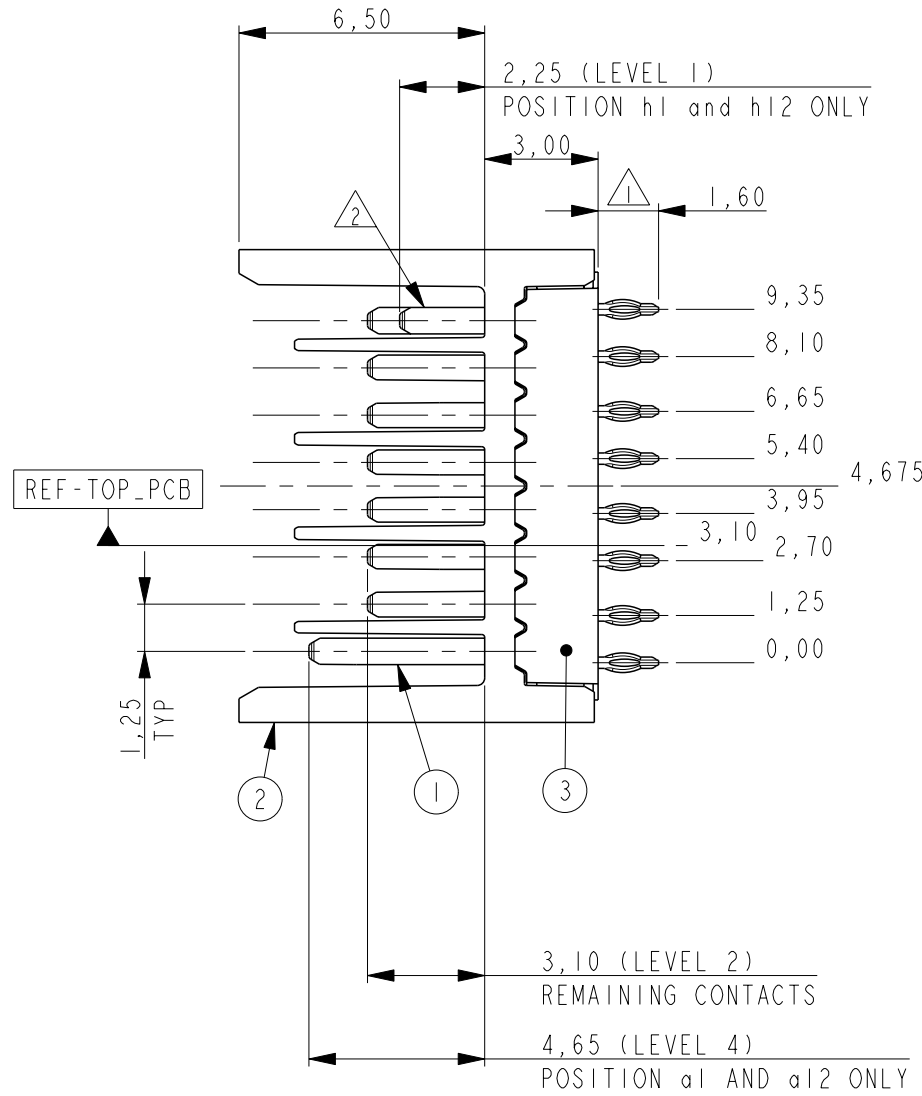
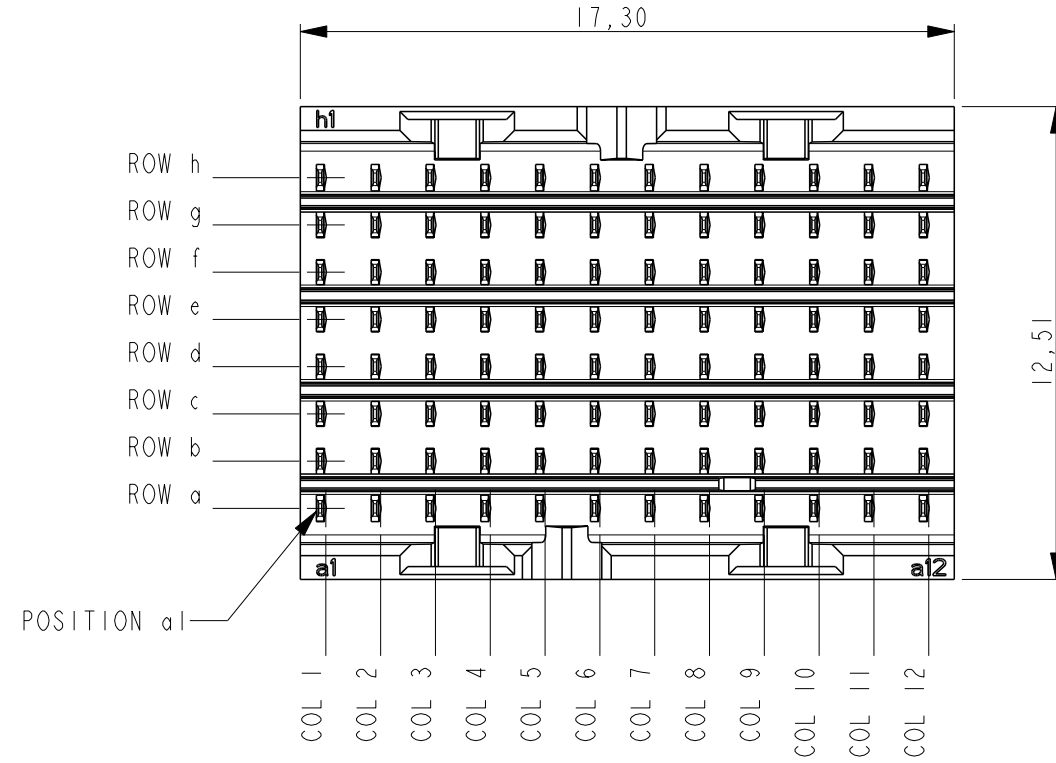
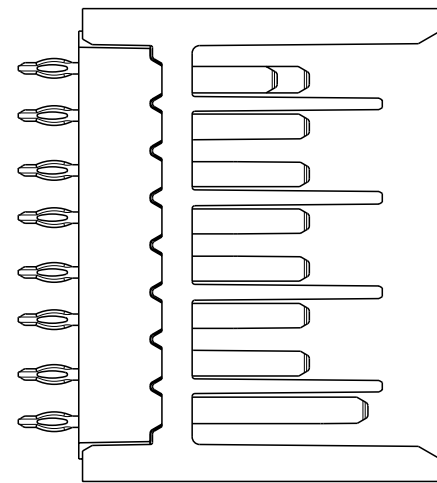
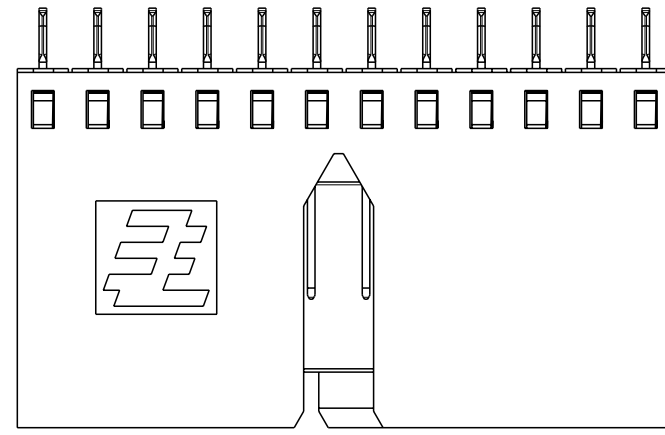

NOTES:

- 1 PLATING: 0,5µm MIN. TIN OVER NICKEL.
- 2 PLATING:

PARTNUMBER	PERFORMANCE LEVEL
2173043-1	PERFORMANCE LEVEL 1: CONNECTOR TESTED AND QUALIFIED AGAINST TELCORDIA GR-1217-CORE QUALITY LEVEL 111; UNCONTROLLED ENVIRONMENT APPLICATIONS. SEE PRODUCT SPEC 108-19353
2173043-2	PERFORMANCE LEVEL 2: CONFORMS TO ALL TESTING ACCORDING PRODUCT SPEC 108-19320, -250 MATING CYCLES, 4 DAYS MIXED GAS TEST PER IEC 60068-2-60 METHOD 1

- 3 CONSULT APPLICATION SPEC OR CONTACT TE CONNECTIVITY FOR PERMISSIBLE CONTACT ASSIGNMENTS.
- 4 CONNECTOR MARKED WITH PARTNUMBER AND DATE CODE.
- 5 FOR PC-BOARD ROUTING RECOMMENDATIONS SEE SPEC 114-19140

PRODUCT HAS NOT COMPLETED QUALIFICATION TESTING

THIS DRAWING IS A CONTROLLED DOCUMENT.		DWN: J.V.D.HELJDEN 04 MAR 2011	3 OVERMOLD		LCP 30% GF NATURAL
DIMENSIONS: mm		CHK: B.MOOLJ 04 MAR 2011	2 HOUSING		LCP 30% GF NATURAL
TOLERANCES UNLESS OTHERWISE SPECIFIED:		APVD: I.D.Boer 07 MAR 2011	1 CONTACT		COPPER ALLOY
0 PLC ±		PRODUCT SPEC	ITEM NO.		DESCRIPTION
1 PLC ±		APPLICATION SPEC	NAME		MALE CONNECTOR Z-PACK Slim UHD
2 PLC ±		114-19106	SIZE	CAGE CODE	DRAWING NO
3 PLC ±		WEIGHT	A2	00779	©-2173043
4 PLC ±		CUSTOMER DRAWING	SCALE	5:1	SHEET 1 OF 1
ANGLES ±					REV A
FINISH ±					

单击下面可查看定价，库存，交付和生命周期等信息

[>>TE Connectivity\(泰科\)](#)