

Three Phase Superior Performance EMI Filter – Single Stage WYE Configuration

DATASHEET

Provides superior performance when used in applications with low Impedance load controlling pulsed, continuous and intermittent interference noise and where high levels of mains borne interference are present.

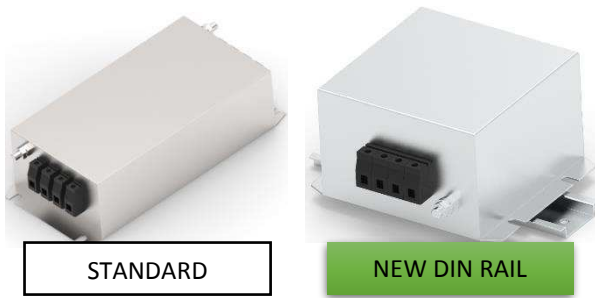

Typical Circuit Diagram

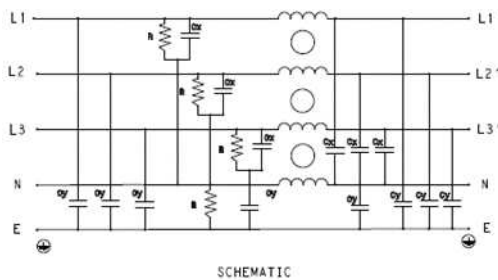

Specifications

Electrical Characteristics

Maximum Continuous Operating Voltage	440/520VAC
Current Ratings	6A to 250A @40°C, Din Mount 1A to 50A @40°C
Operating Frequency	50/60Hz
High Potential Test Voltage -440VAC	Line to Ground 2632VDC for 1 Minute Line to Line 1892VDC for 1 Minute
High Potential Test Voltage -520VAC	Line to Ground 2856VDC for 1 Minute Line to Line 2236VDC for 1 Minute
Overload Capability	135% of Rated current for 15 minutes

Functional Characteristics

Operating Temperature Range	-25°C to +85°C
Climatic Category	25/85/21
Termination (Depends on Current Rating)	Shock Proof (6-100A), Nut & Bolt (150-250A)
Flammability corresponding to	UL 94 V-0

Reference Standards

Design Corresponding to	UL 60939-3 and CSA 22.2 No.8-13
-------------------------	---------------------------------

Approvals & Compliance

UL Recognised

CSA Certified *

*30st June 2021



Features

- Compact
- Superior Performance
- Chassis mounting with neutral
- Low Leakage current

Applications

- CNC Machines
- HVAC
- Rectifier
- AC/DC Converters

KEP SERIES



Selection Table – Standard Version



TE Part Number	Catalog Number	Rated Current @40°C	Rated Voltage @40°C	Leakage Current (mA)	Termination		Weight (Kgs)
1-1609968-0	6KEPS10AFPW	6A	440 VAC	8.5	41		1
1-1609968-1	8KEPS10AFPW	8A	440 VAC	8.5	41		2
1-1609968-2	10KEPS10AFPW	10A	440 VAC	8.5	41		2
1-1609968-3	16KEPS10AFPW	16A	440 VAC	8.5	41		3
1-1609968-4	20KEPS10AFPW	20A	440 VAC	8.5	41		3
1-1609968-5	25KEPS10AFPW	25A	440 VAC	8.5	41		3
1-1609968-6	36KEPS10AFPW	36A	440 VAC	8.5	10		3
1-1609968-7	50KEPS10AFPW	50A	440 VAC	8.5	10		3
2-1609968-0	60KEPS10AFPW	60A	440 VAC	8.5	16		8
2-1609968-1	75KEPS10AFPW	75A	440 VAC	12	16		8
2-1609968-2	100KEPS10AFPW	100A	440 VAC	12	25		8
2-1609968-3	125KEPS6AFPW	125A	440 VAC	12		M10	9
2-1609968-4	150KEPS6AFPW	150A	440 VAC	12		M10	9
2-1609968-5	200KEPS6AFPW	200A	440 VAC	12		M10	11
2-1609968-6	250KEPS6AFPW	250A	440 VAC	12		M10	11
4-1609968-0	6KEPS10AFPW	6A	520 VAC	8.5	41		1
4-1609968-1	8KEPS10AFPW	8A	520 VAC	8.5	41		2
4-1609968-2	10KEPS10AFPW	10A	520 VAC	8.5	41		2
4-1609968-3	16KEPS10AFPW	16A	520 VAC	8.5	41		3
4-1609968-4	20KEPS10AFPW	20A	520 VAC	8.5	41		3
4-1609968-5	25KEPS10AFPW	25A	520 VAC	8.5	41		3
4-1609968-6	36KEPS10AFPW	36A	520 VAC	8.5	10		3
4-1609968-7	50KEPS10AFPW	50A	520 VAC	8.5	10		3
5-1609968-0	60KEPS10AFPW	60A	520 VAC	8.5	16		8
5-1609968-1	75KEPS10AFPW	75A	520 VAC	12	16		8
5-1609968-2	100KEPS10AFPW	100A	520 VAC	12	25		8
5-1609968-3	125KEPS6AFPW	125A	520 VAC	12		M10	9
5-1609968-4	150KEPS6AFPW	150A	520 VAC	12		M10	9
5-1609968-5	200KEPS6AFPW	200A	520 VAC	12		M10	11
5-1609968-6	250KEPS6AFPW	250A	520 VAC	12		M10	11

Selection Table – Din Rail Mount



NEW

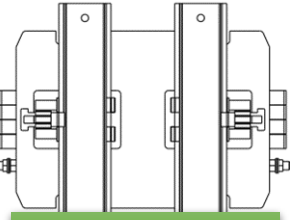
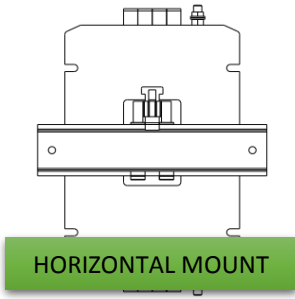

Note: Din Rail not supplied

TE Part Number	Catalog Number	Din Type	Rated Current @40°C	Rated Voltage @40°C	Leakage Current (mA)	Termination 	Weight (Kgs)
8-1609968-2	6KEPS10AFPWHM	HORIZONTAL	6A	440 VAC	8.5	41	1.1
8-1609968-3	8KEPS10AFPWHM	HORIZONTAL	8A	440 VAC	8.5	41	2.1
8-1609968-4	10KEPS10AFPWHM	HORIZONTAL	10A	440 VAC	8.5	41	2.1
8-1609968-5	6KEPS10AFPWVM	VERTICAL	6A	440 VAC	8.5	41	1.2
8-1609968-6	8KEPS10AFPWVM	VERTICAL	8A	440 VAC	8.5	41	2.2
8-1609968-7	10KEPS10AFPWVM	VERTICAL	10A	440 VAC	8.5	41	2.2
8-1609968-8	16KEPS10AFPWHM	HORIZONTAL	16A	440 VAC	8.5	41	3.2
8-1609968-9	20KEPS10AFPWHM	HORIZONTAL	20A	440 VAC	8.5	41	3.2
9-1609968-0	25KEPS10AFPWHM	HORIZONTAL	25A	440 VAC	8.5	41	3.2
9-1609968-1	36KEPS10AFPWHM	HORIZONTAL	36A	440 VAC	8.5	10	3.2
9-1609968-2	50KEPS10AFPWHM	HORIZONTAL	50A	440 VAC	8.5	10	3.2
7-1609969-4	6KEPS10BFPWHM	HORIZONTAL	6A	520 VAC	8.5	41	1.1
7-1609969-5	8KEPS10BFPWHM	HORIZONTAL	8A	520 VAC	8.5	41	2.1
7-1609969-6	10KEPS10BFPWHM	HORIZONTAL	10A	520 VAC	8.5	41	2.1
7-1609969-7	6KEPS10BFPWVM	VERTICAL	6A	520 VAC	8.5	41	1.2
7-1609969-8	8KEPS10BFPWVM	VERTICAL	8A	520 VAC	8.5	41	2.2
7-1609969-9	10KEPS10BFPWVM	VERTICAL	10A	520 VAC	8.5	41	2.2
8-1609969-0	16KEPS10BFPWHM	HORIZONTAL	16A	520 VAC	8.5	41	3.2
8-1609969-1	20KEPS10BFPWHM	HORIZONTAL	20A	520 VAC	8.5	41	3.2
8-1609969-2	25KEPS10BFPWHM	HORIZONTAL	25A	520 VAC	8.5	41	3.2
8-1609969-3	36KEPS10BFPWHM	HORIZONTAL	36A	520 VAC	8.5	10	3.2
8-1609969-4	50KEPS10BFPWHM	HORIZONTAL	50A	520 VAC	8.5	10	3.2

Connectors Cross Section

	41	10	16	25	50
Wire Section (mm ²)	4mm ²	10 mm ²	16 mm ²	25 mm ²	50 mm ²
Wire Section (AWG)	12AWG	8 AWG	6 AWG	4 AWG	1/0 AWG
Wire Stripping	Max 10mm	max 13.5 mm	max 17 mm	max 17 mm	max 20 mm
Max Recommended Torque	0.5 Nm / 4.5 in.lbs	1.2 Nm / 10.8 in.lbs	2÷2.2 Nm / 18÷19.8 in.lbs	2 Nm / 18 in.lbs	6 Nm / 54 in.lbs

Insertion Loss (Typical) – Measured in Closed 50Ω System

Common Mode 50Ω / 50Ω

		Frequency in MHz								
		0.01	0.05	0.15	0.5	1	3	5	10	30
Current Rating	6A	61	60	60	55	49	40	38	34	26
	8A	62	64	57	52	50	44	36	32	28
	10A	60	60	59	54	50	42	37	32	26
	16A	54	58	59	54	49	41	37	31	28
	20A	55	57	60	51	45	38	30	28	32
	25A	54	58	50	54	47	43	38	33	25
	36A	57	56	58	51	50	48	35	33	31
	50A	68	65	63	54	49	42	38	32	36
	60A	46	44	40	40	31	40	38	30	21
	75A	50	50	51	53	50	48	42	36	34
	100A	54	50	50	52	60	48	42	38	34
	125A	52	50	45	50	58	48	44	40	38
	150A	36	38	41	53	48	50	45	31	21
	200A	32	39	41	53	45	52	45	30	21
	250A	37	38	45	53	48	39	35	31	23

Differential Mode 50Ω / 50Ω

		Frequency in MHz								
		0.01	0.05	0.15	0.5	1	3	5	10	30
Current Rating	6A	56	52	54	50	47	35	30	40	32
	8A	45	35	42	54	48	35	40	29	26
	10A	30	31	40	54	46	38	33	29	24
	16A	27	32	55	53	47	36	35	30	27
	20A	35	32	52	50	47	36	33	30	25
	25A	51	51	53	52	45	37	35	30	25
	36A	49	50	65	82	86	70	65	66	37
	50A	58	52	60	50	43	50	42	38	30
	60A	54	50	62	68	63	50	55	63	52
	75A	48	42	40	60	38	40	40	39	35
	100A	48	42	40	62	38	44	42	40	32
	125A	48	42	40	62	38	50	46	42	34
	150A	25	28	30	46	55	48	46	34	38
	200A	27	28	30	46	55	48	46	34	38
	250A	42	42	45	46	40	34	29	24	18

Common Mode Insertion Loss (Typical in dB – refer to Table above)

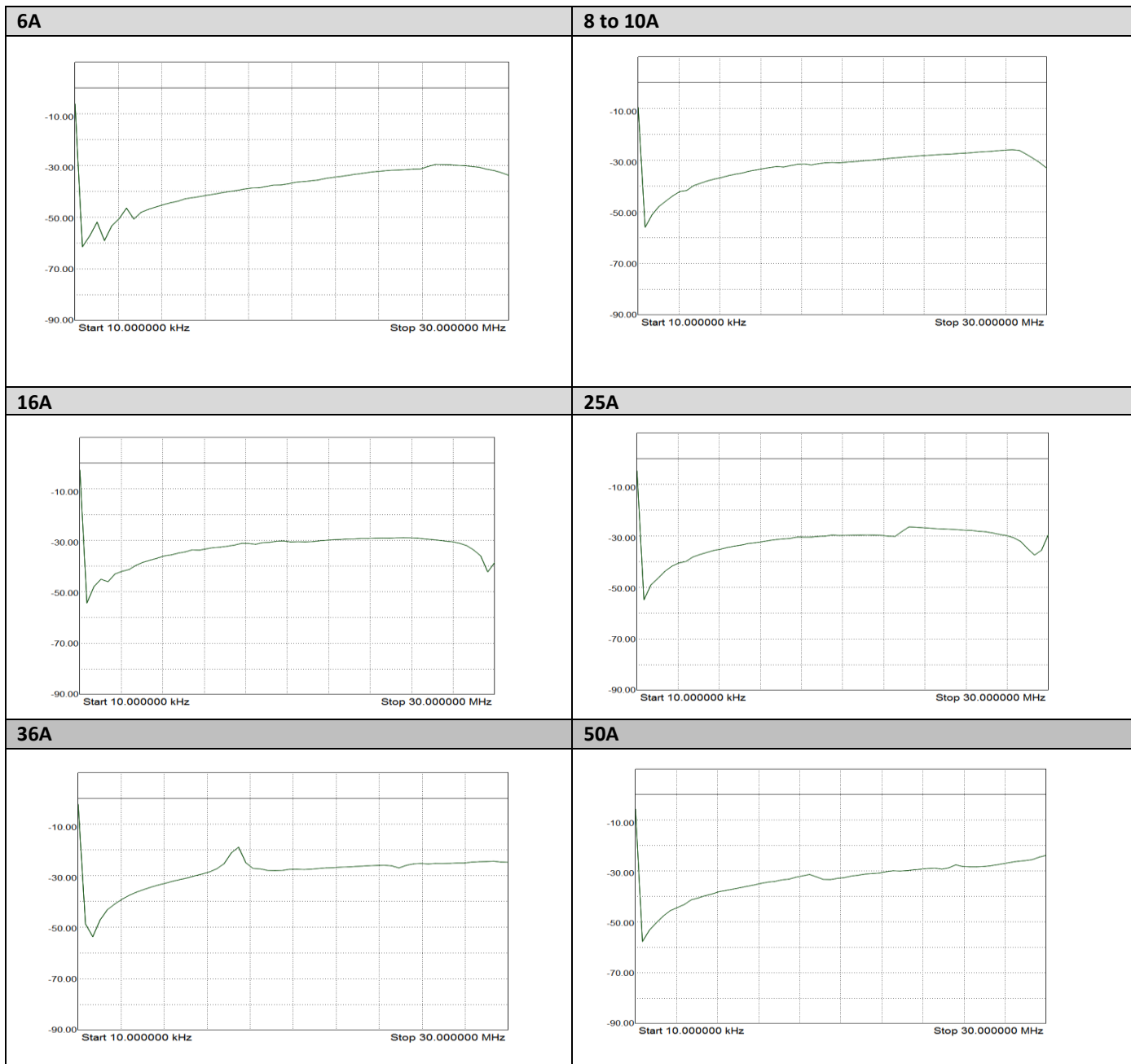

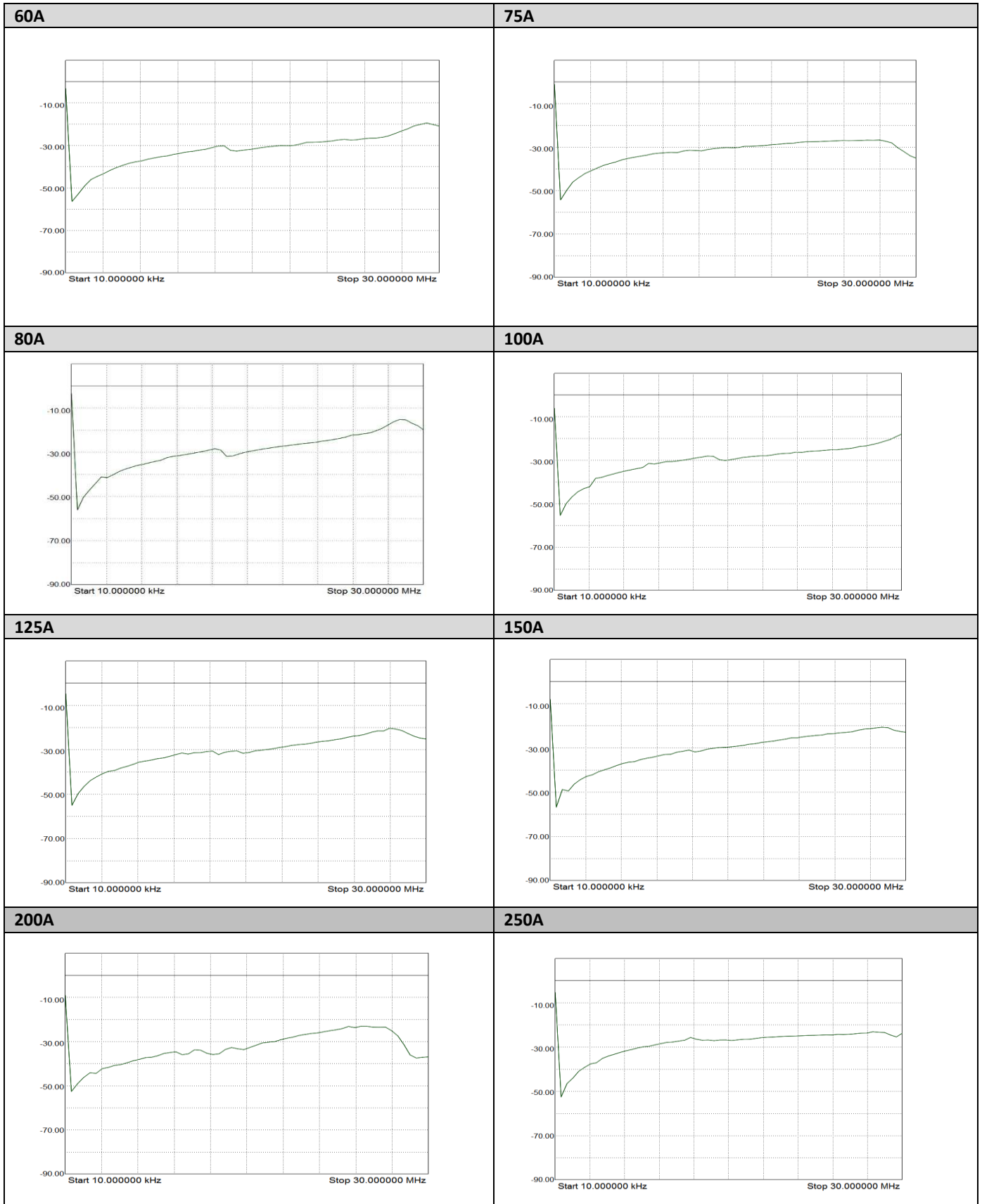

Case Dimensions – Standard Version

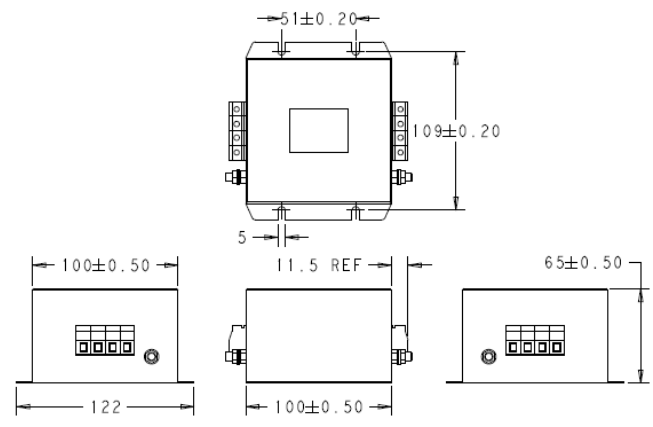
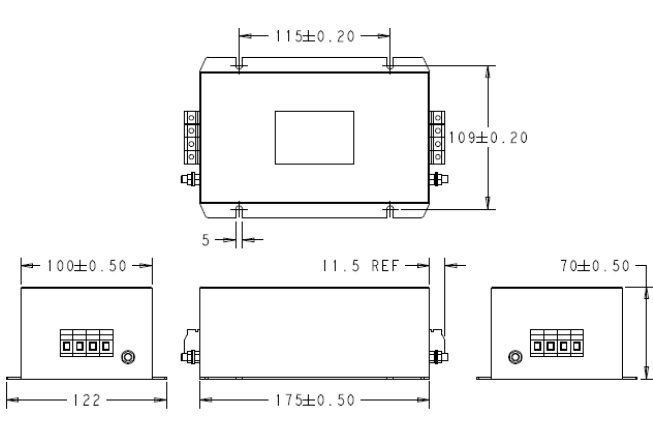
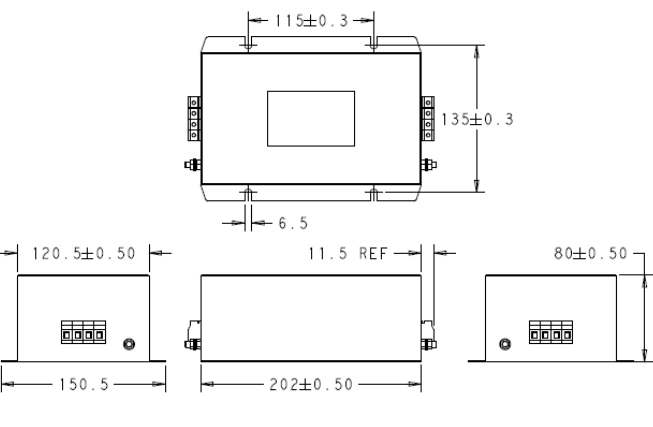
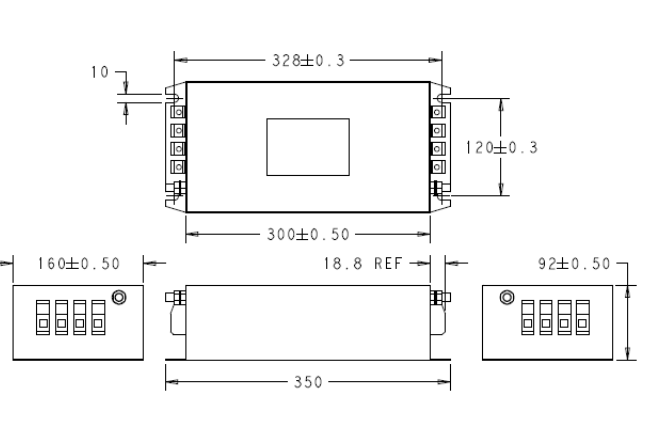
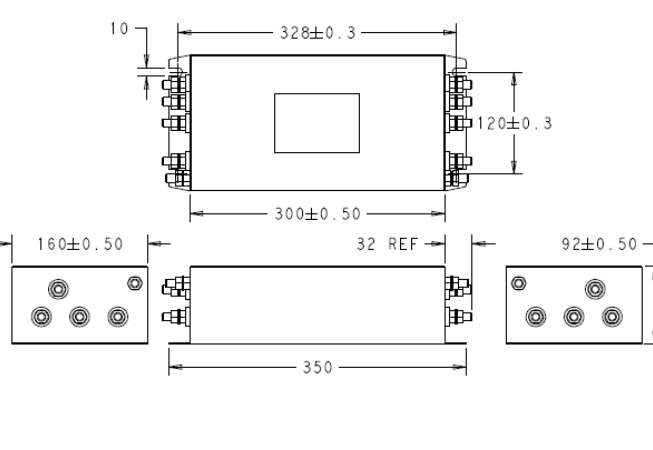
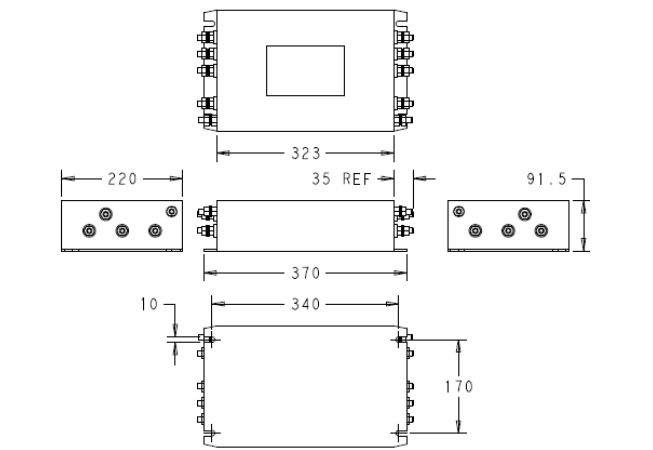
6A Shock Proof Type	8A to 10A Shock Proof Types
	
15A to 50A Shock Proof Types	60A to 100A Shock Proof Types
	
125A to 150A Nut & Bolt Types	200A to 250A Nut & Bolt Types
	

All dimensions in mm; Tolerances according: ISO2768-m

Case Dimensions – Din Rail Mount

6A Shock Proof Type – Horizontal Mount

Note: Din Rail not supplied

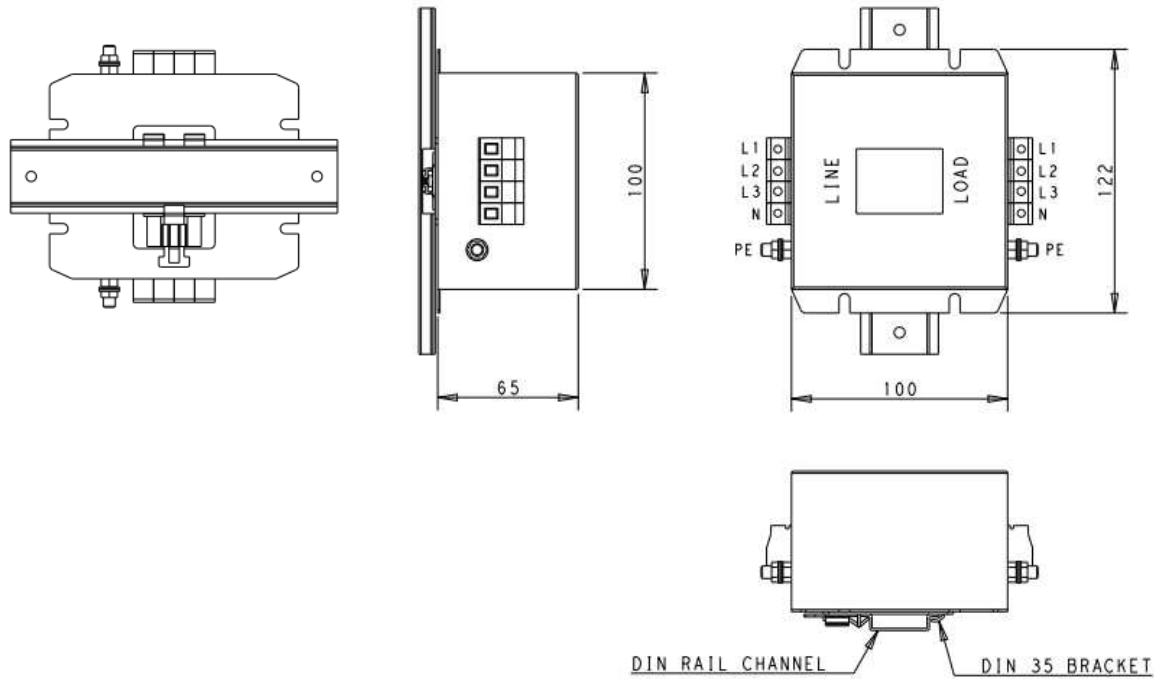

6A Shock Proof Type – Vertical Mount

Note: Din Rail not supplied

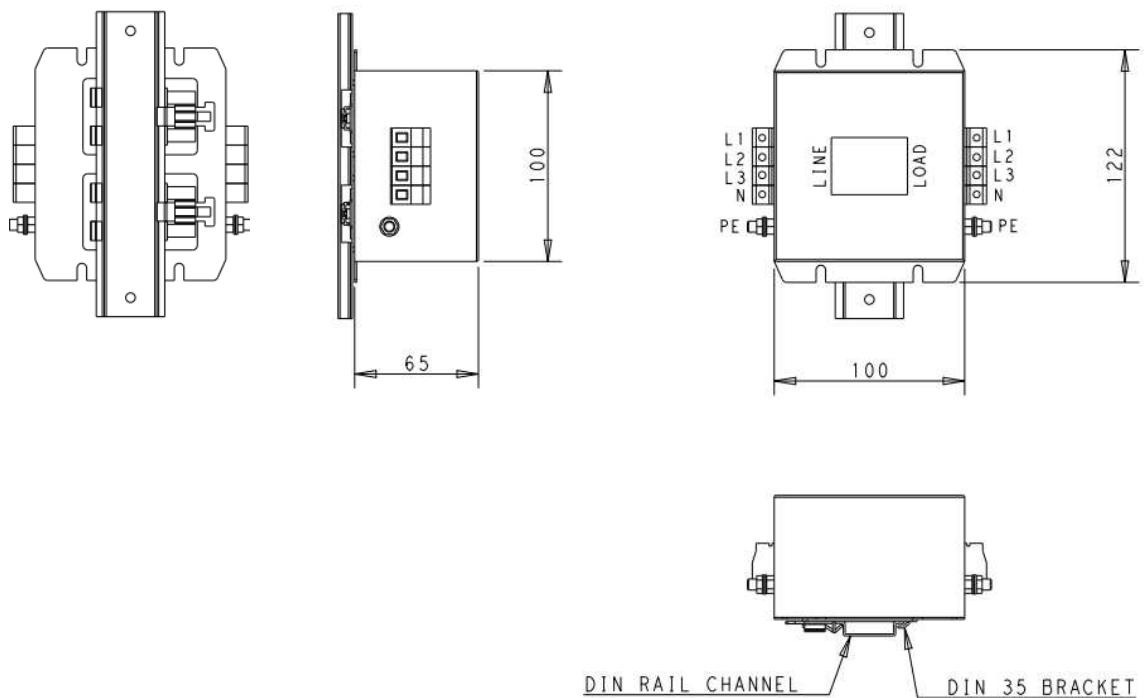

KEP SERIES



8A to 10A Shock Proof Types – Horizontal Mount

Note: Din Rail not supplied

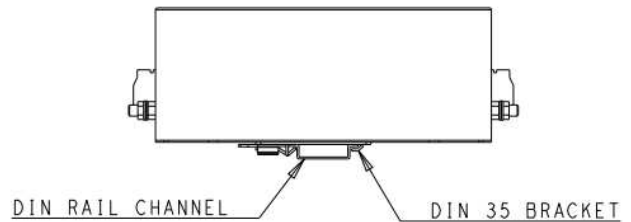
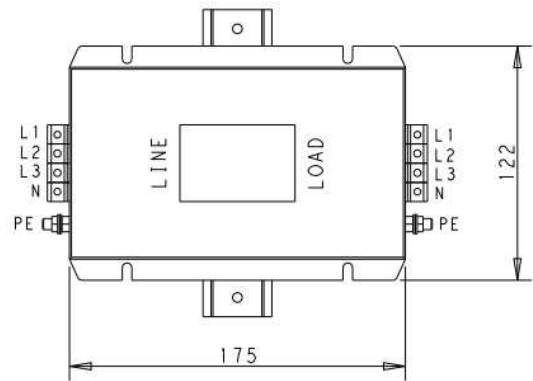
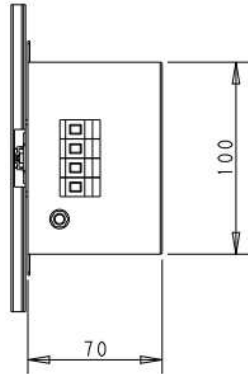
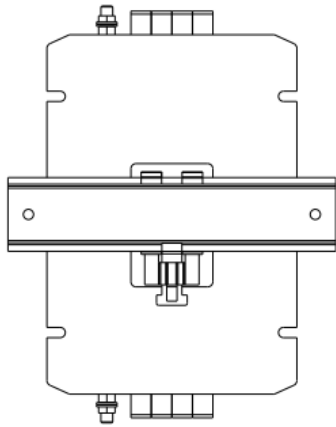

8A to 10A Shock Proof Types – Vertical Mount

Note: Din Rail not supplied

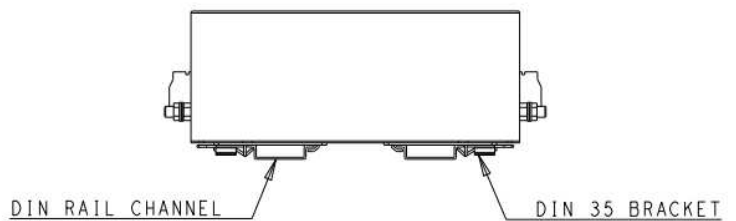
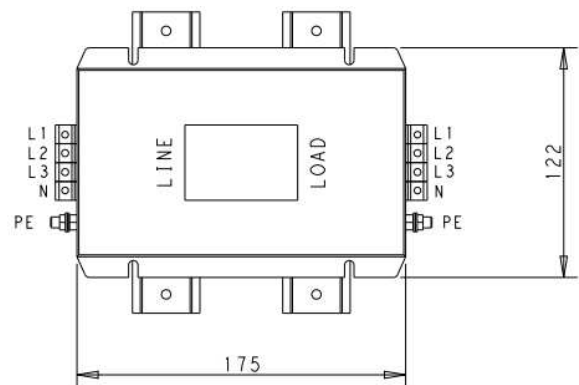
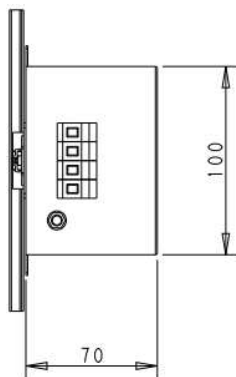
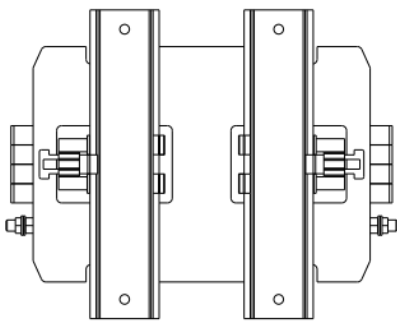

16A to 50A Shock Proof Types – Horizontal Mount

Note: Din Rail not supplied

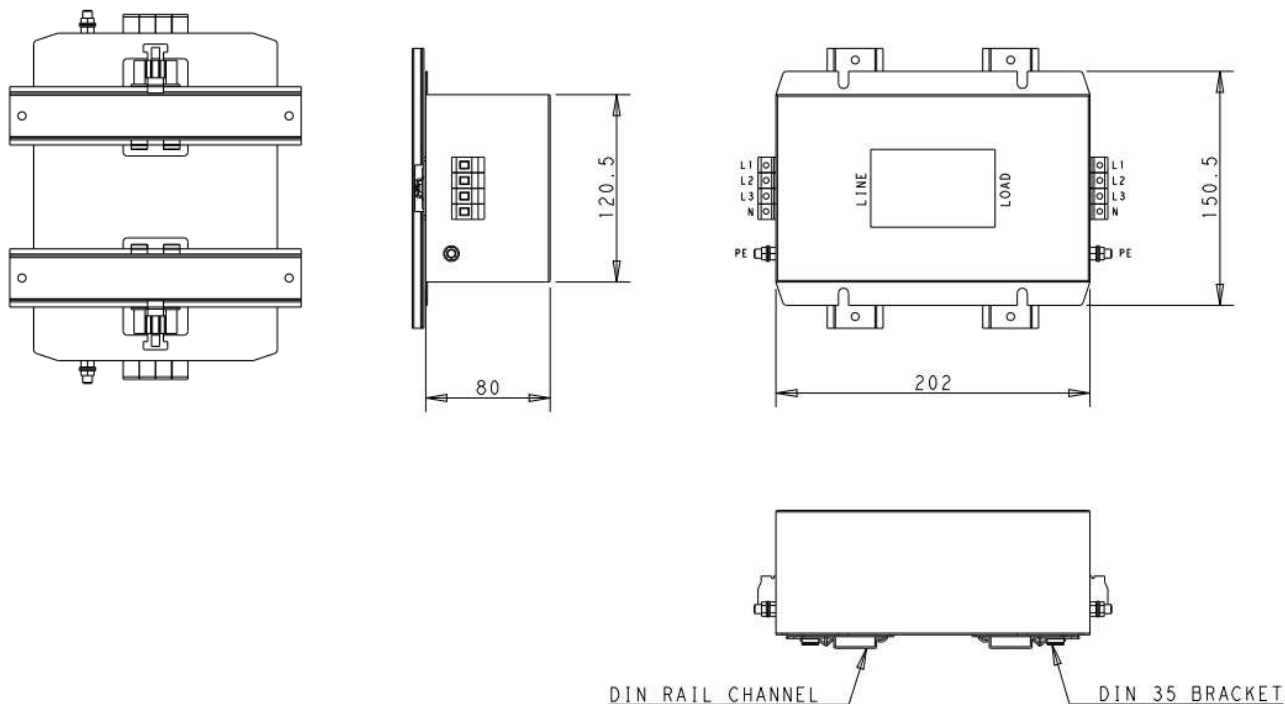

How to Order

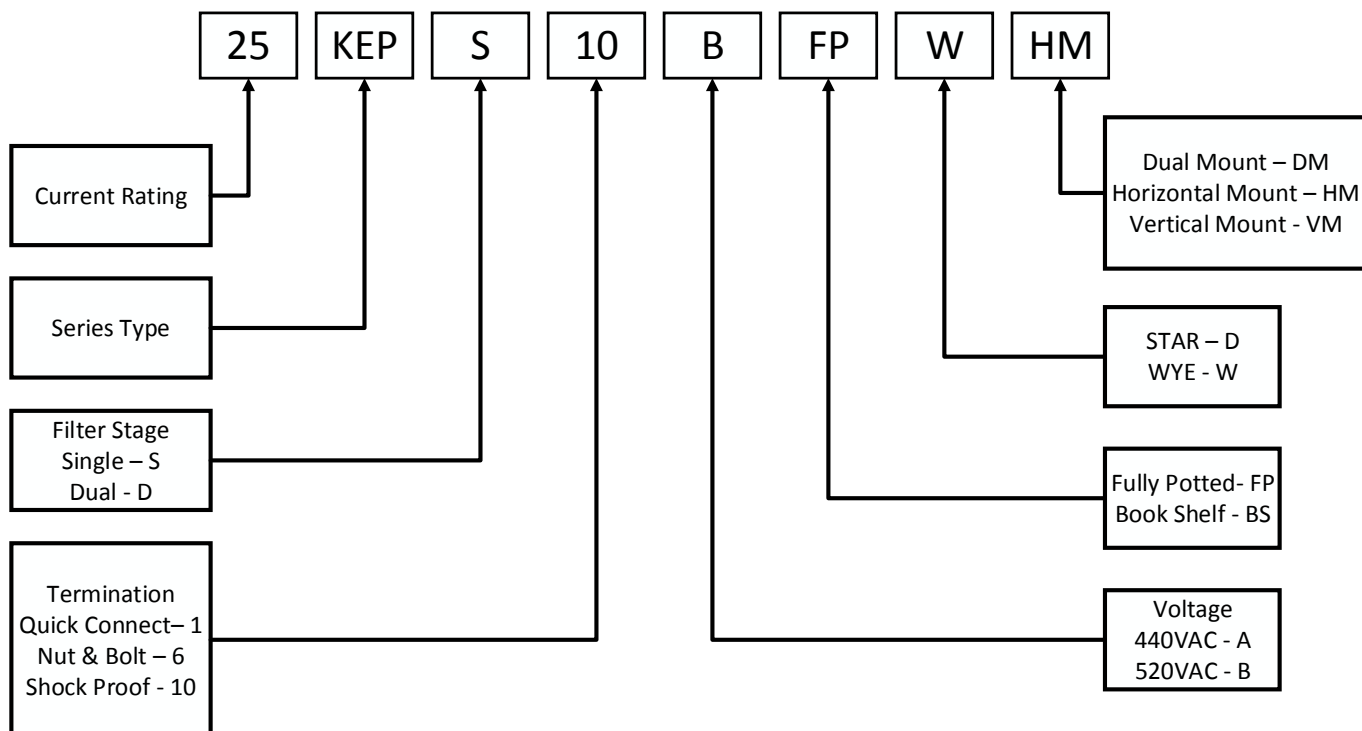

单击下面可查看定价，库存，交付和生命周期等信息

[>>TE Connectivity\(泰科\)](#)