

THIS DRAWING IS UNPUBLISHED. RELEASED FOR PUBLICATION 20  
 © COPYRIGHT 2012 ALL RIGHTS RESERVED.

LOC	DIST	REVISIONS					
		P	LTR	DESCRIPTION	DATE	DWN	APVD
J	-	A		RELEASED FOR PRODUCTION	07MAR2016	TX	SH

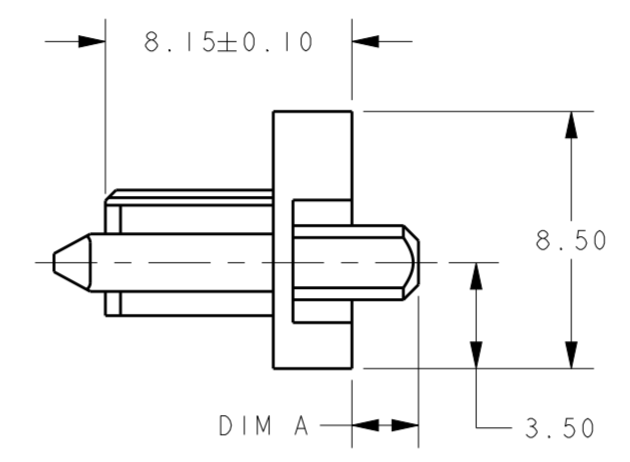

- NOTES:
- MATERIAL:  
HOUSING: HIGH TEMP THERMOPLASTIC, UL94V-0,  
COLOR: BLACK  
CONTACT: COPPER ALLOY  
BOARDLOCK: COPPER ALLOY
  - FINISH:  
CONTACT AREA: MIN 0.76um GOLD PLATING  
SOLDERTAIL: MIN 2.54um MATTE TIN PLATING  
UNDERPLATE: MIN 1.27um NICKEL PLATING
  - PIN PIN #P4 AND PIN #P12 ONLY
  - SOLDERTAIL TO BE WITHIN 0.05MAX ABOVE AND 0.10MAX BELOW DATUM E
  - 1.33 MAX MEASURED AT DATUM X
  - PACKAGING: TAPE AND REEL

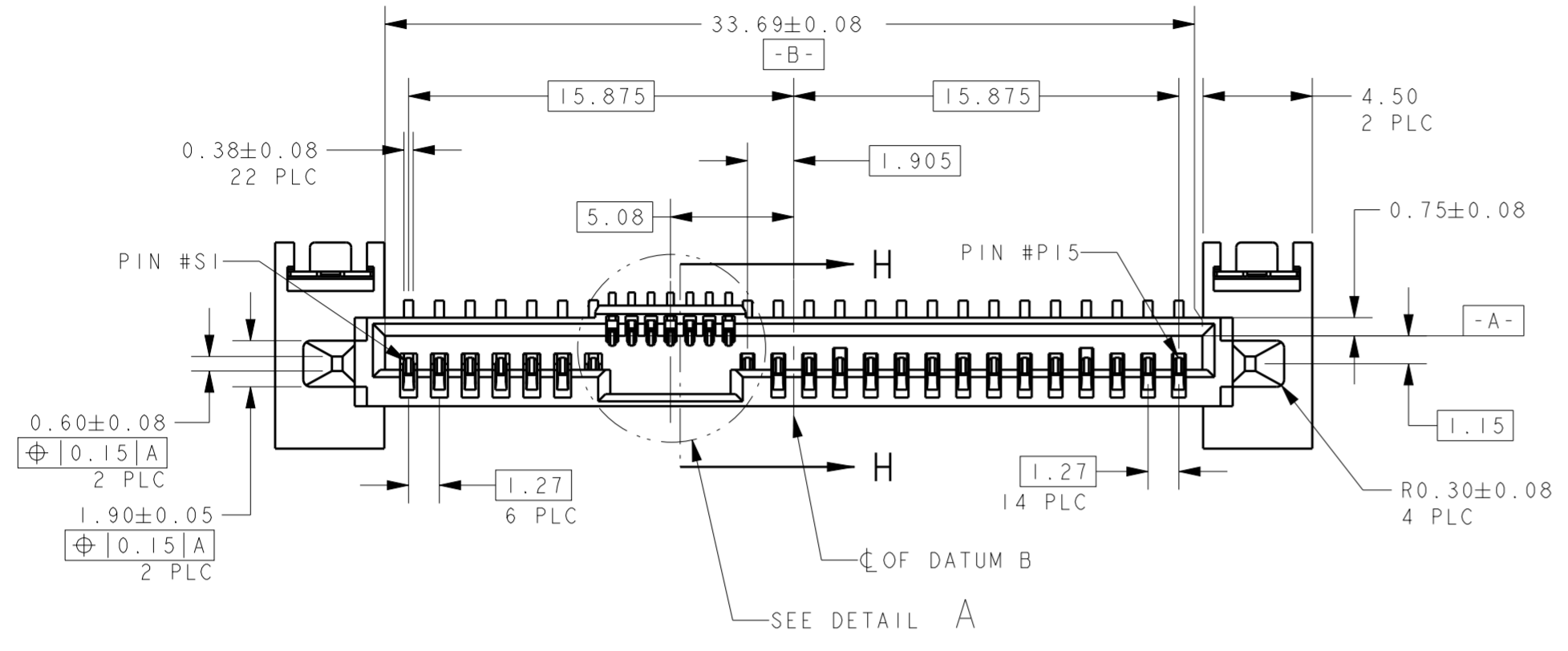
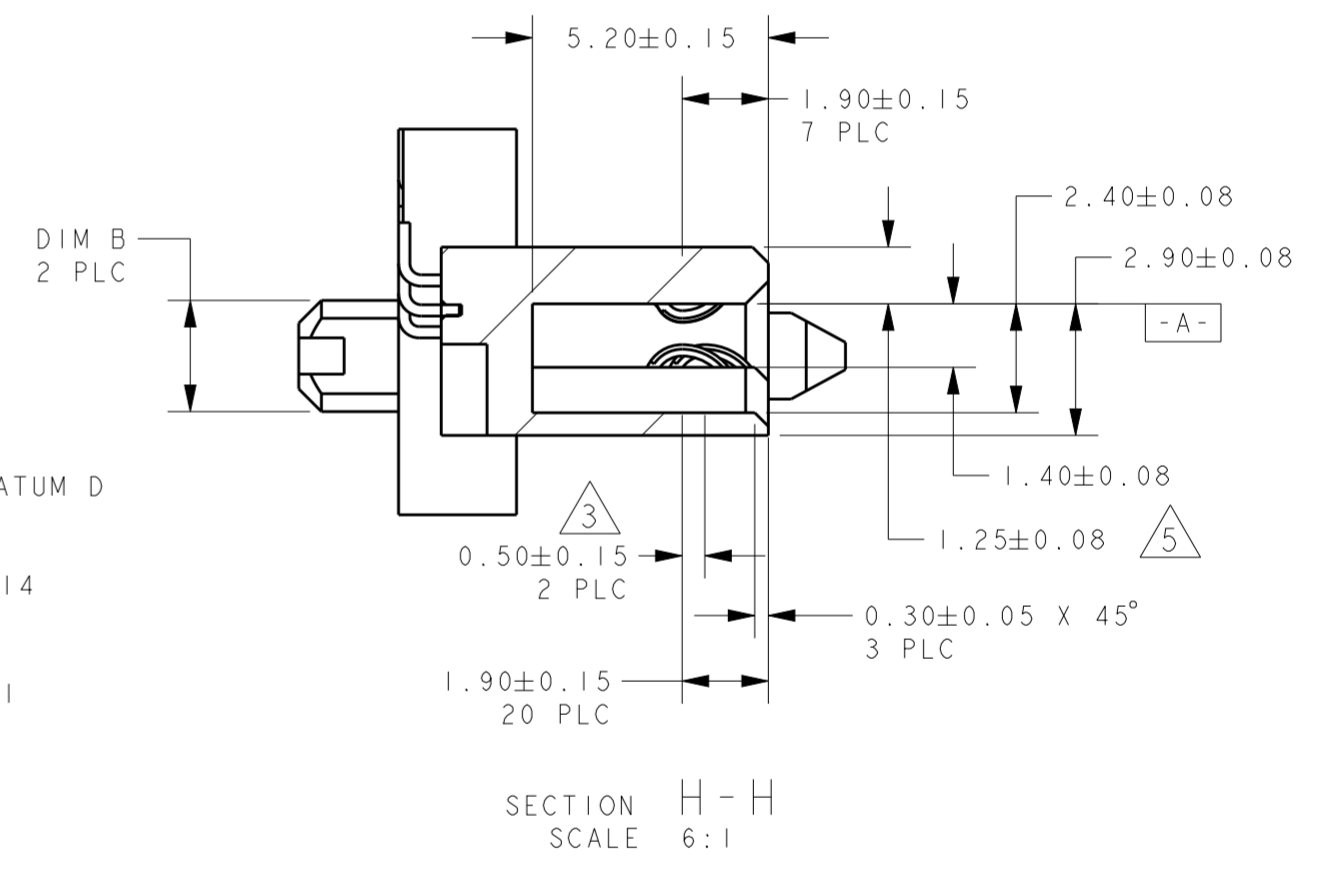
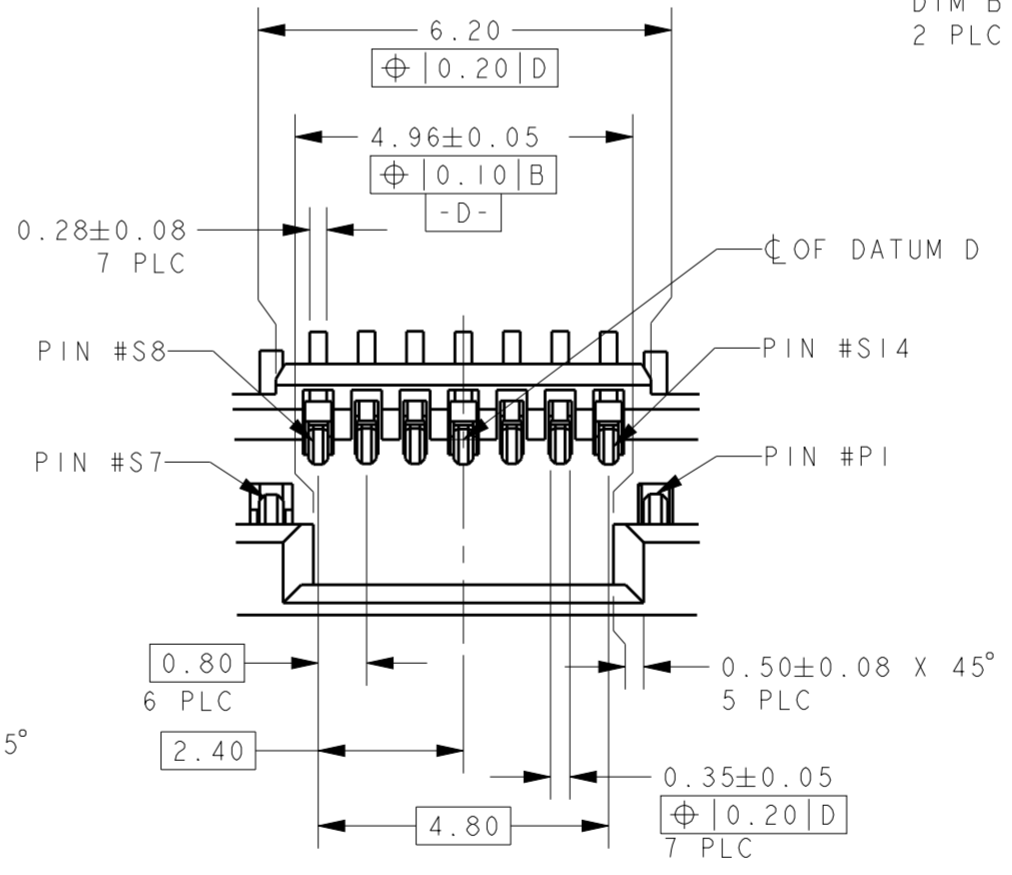
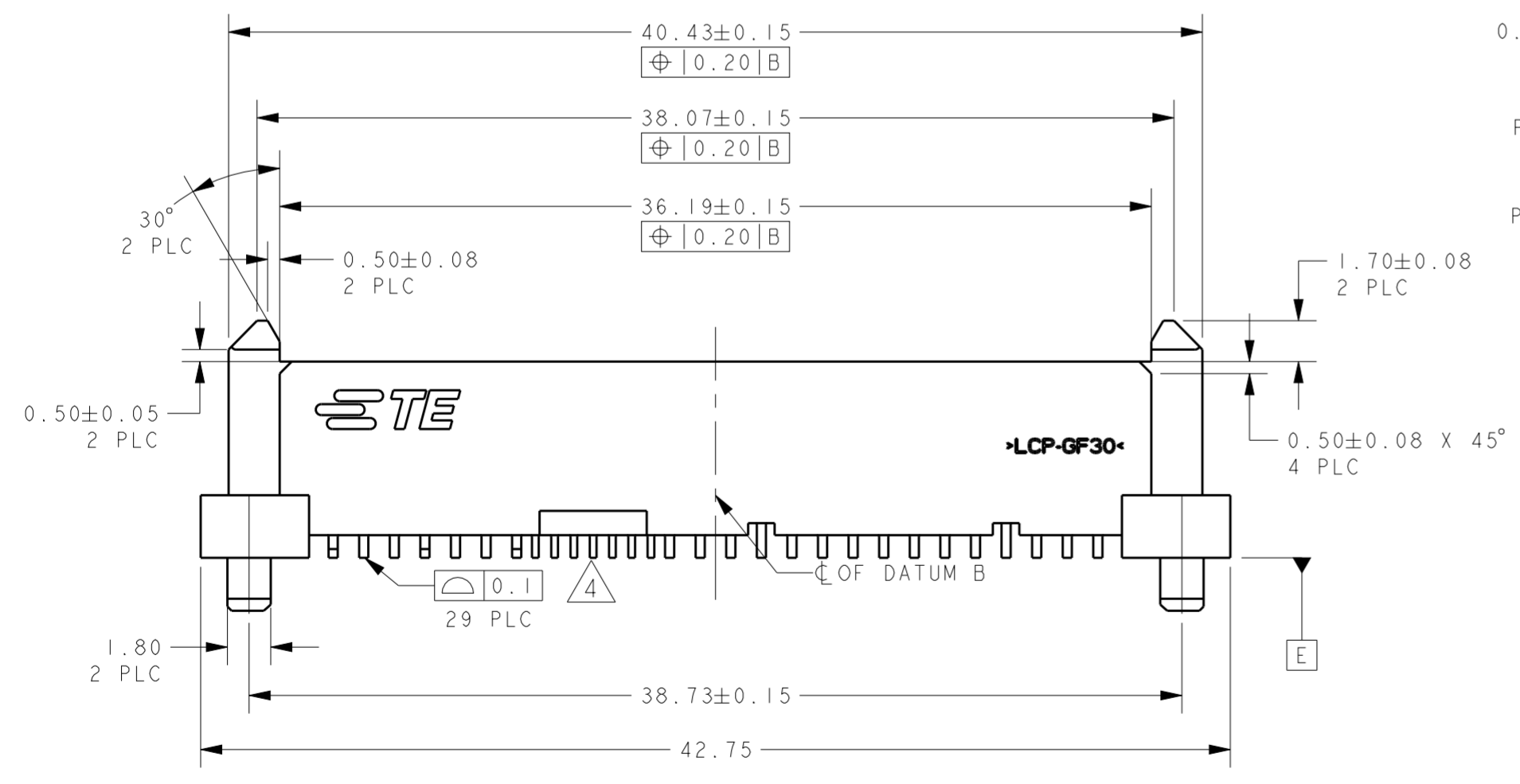

DIM C	DIM B	DIM A	DESCRIPTION	PART NUMBER
Ø1.40	Ø1.26	1.00	WITH PICK-UP CAP	2170563-3
Ø2.50	Ø2.45	2.20	WITHOUT PICK-UP CAP	2170563-2
Ø2.50	Ø2.45	2.20	WITH PICK-UP CAP	2170563-1

THIS DRAWING IS A CONTROLLED DOCUMENT.

DWN	TIM XUE	26 JUL 2013
CHK	ALEX CAI	26 JUL 2013
APVD	ALEX CAI	26 JUL 2013
PRODUCT SPEC	108-51109	
APPLICATION SPEC	114-60017	
WEIGHT		

**STE** TE Connectivity

126 SAS RECEPTACLE  
DUALLINK, WITH BOARDLOCK  
1-SIDED, 15P+7P+7P

SIZE	CAGE CODE	DRAWING NO	RESTRICTED TO
A2	07779	C-2170563	-

CUSTOMER DRAWING SCALE 2:1 SHEET 1 OF 2 REV A

THIS DRAWING IS UNPUBLISHED. RELEASED FOR PUBLICATION 20  
 © COPYRIGHT 2012 ALL RIGHTS RESERVED.

LOC		DIST		REVISIONS			
P	LTR	DESCRIPTION	DATE	DWN	APVD		
-	-	SEE SHEET 1	-	-	-		

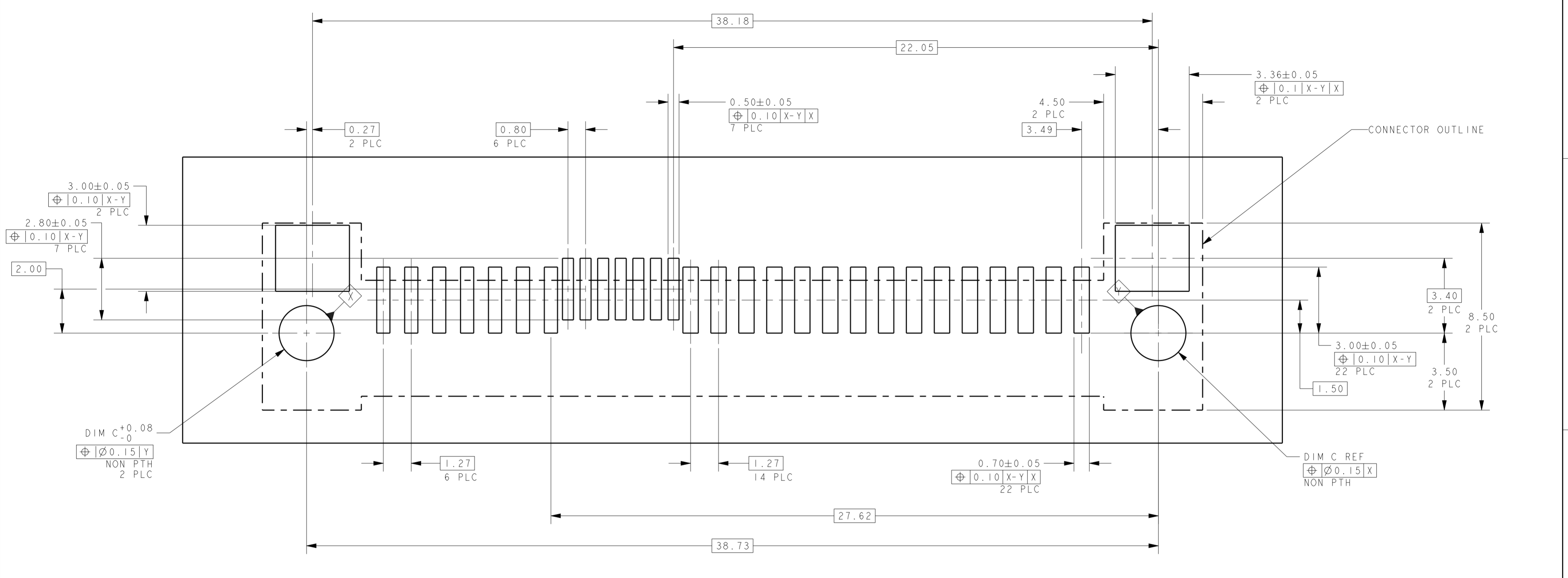

RECOMMENDED RECEPTACLE BOARD LAYOUT  
 SCALE 8:1

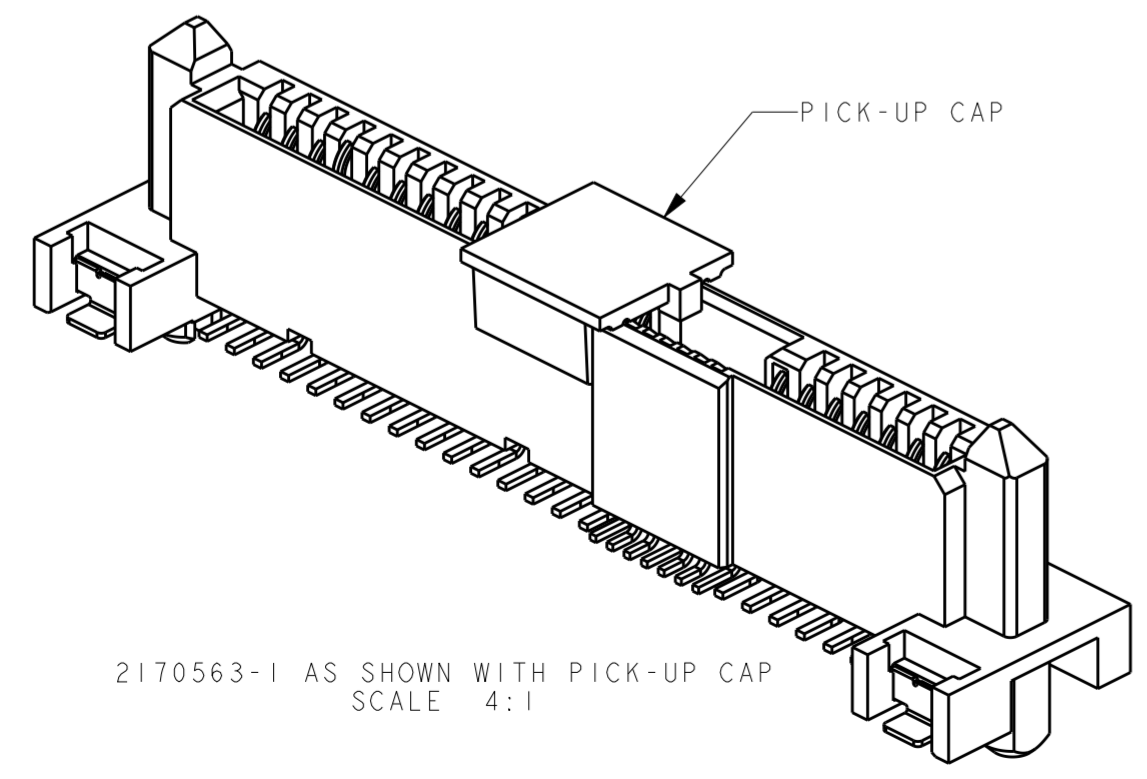

2170563-1 AS SHOWN WITH PICK-UP CAP  
 SCALE 4:1

THIS DRAWING IS A CONTROLLED DOCUMENT.		DWN TIM XUE 26 JUL 2013	TE Connectivity	
DIMENSIONS: mm		CHK ALEX CAI 26 JUL 2013		
TOLERANCES UNLESS OTHERWISE SPECIFIED:		APVD ALEX CAI 26 JUL 2013	NAME 12G SAS RECEPTACLE DUALINK, WITH BOARDLOCK 1-SIDED, 15P+7P+7P	
0 PLC ± 1 PLC ±0.20 2 PLC ±0.20 3 PLC ±0.20 4 PLC ± ANGLES ±3° FINISH		PRODUCT SPEC 108-51109	SIZE A20779	
MATERIAL		APPLICATION SPEC 114-60017	DRAWING NO C-2170563	
		WEIGHT	RESTRICTED TO -	
		CUSTOMER DRAWING	SCALE 2:1 SHEET 2 OF 2 REV A	

单击下面可查看定价，库存，交付和生命周期等信息

[>>TE Connectivity\(泰科\)](#)