



Wi-Fi 6/ 6E TRIPLE BAND ON BOARD ANTENNA

Part Numbers: 2118908-1, 2118908-2

FEATURES & BENEFITS

- WiFi 6, also including WiFi 6E new 6GHz band, Bluetooth, ZigBee
- Global Frequency coverage
- On board SMD mount PCB IFA antenna
- Minimal keep out zone requirement
- Performance dependent on ground plane size and design

SPECIFICATIONS

Frequency Range (MHz)	2400-2485	5150-5875	5925-7125
VSWR	< 2.0:1	< 2.5:1	< 2.5:1
Average Efficiency	80%	85%	80%
Peak Gain	2.3dBi	2.8dBi	2.3dBi
Average Gain	-1.0dBi	-0.7dBi	-1.0dBi
Power Handling	10 Watt cw		
Feed Point Impedance	50 ohms		
Polarization	Linear		
Size	18.9 mm x 6.2 mm x 0.76 mm		
Weight	< 0.2 g		
Mounting	Surface mount		
Operating Temperature	-40 to +85°C		
Storage Temperature	-40 to +85°C		
Packaging Specification	Bag & Box / Tape & Reel		
Hazardous Materials	A certificate of conformance is available from the product page on TE website.		

Data measured in free space and on reference ground plane of 33 mm length and 35 mm width, application data might vary

Wi-Fi 6/ 6E TRIPLE BAND ON BOARD ANTENNA

Standard Antenna Solutions

RF DATA

VSWR

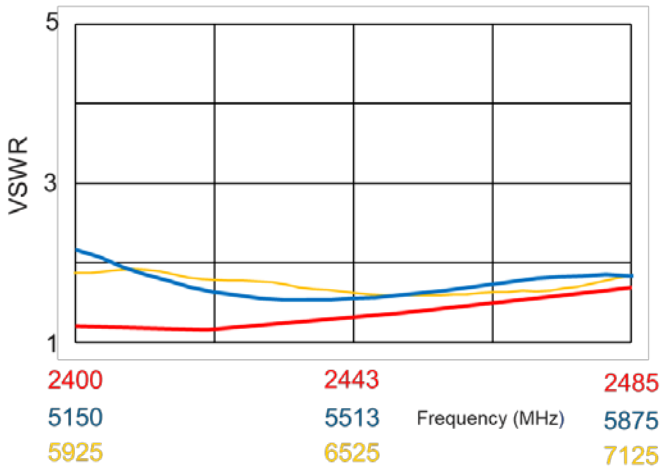

Return Loss

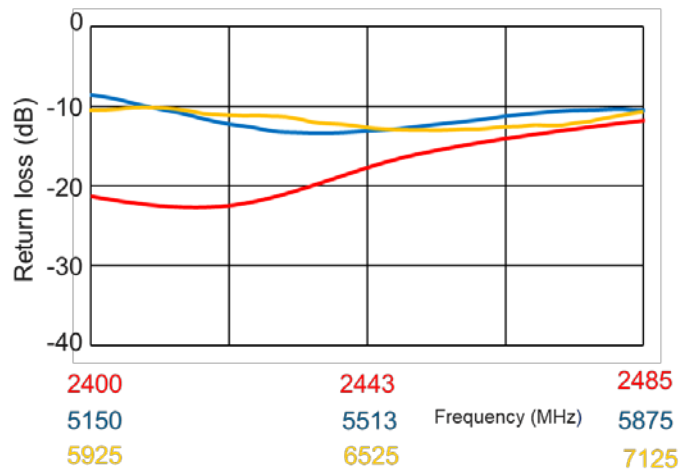

Efficiency

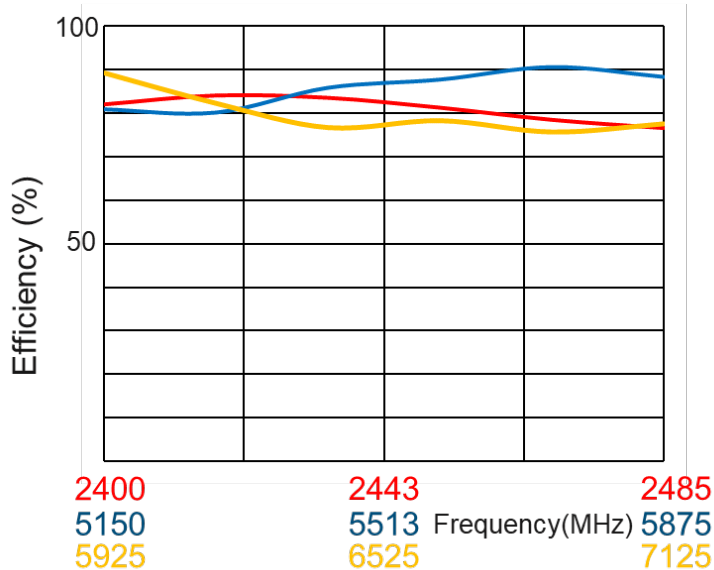

Data measured in free space and on reference ground plane of 33 mm length and 35 mm width, application data might vary

RADIATION PATTERN

Test setup

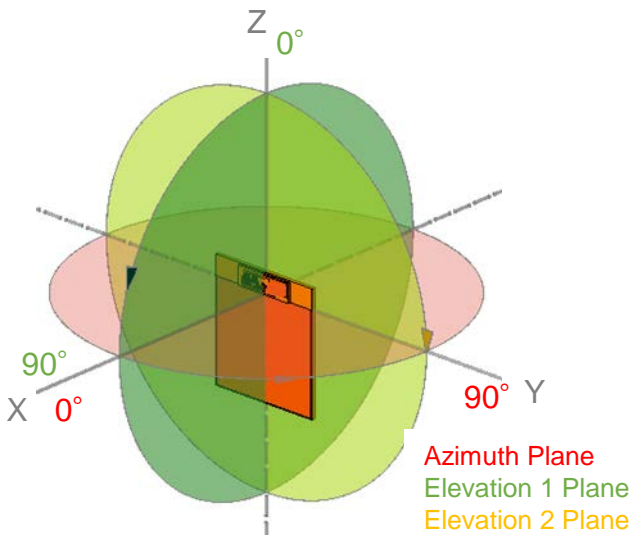

Azimuth

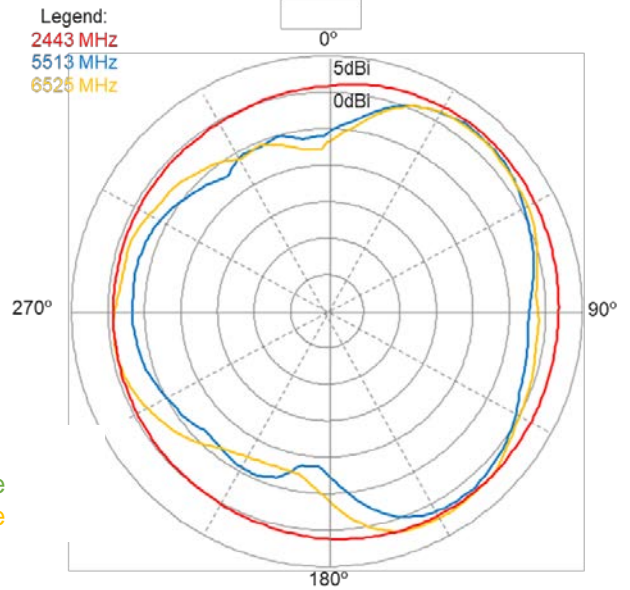

Elevation 1

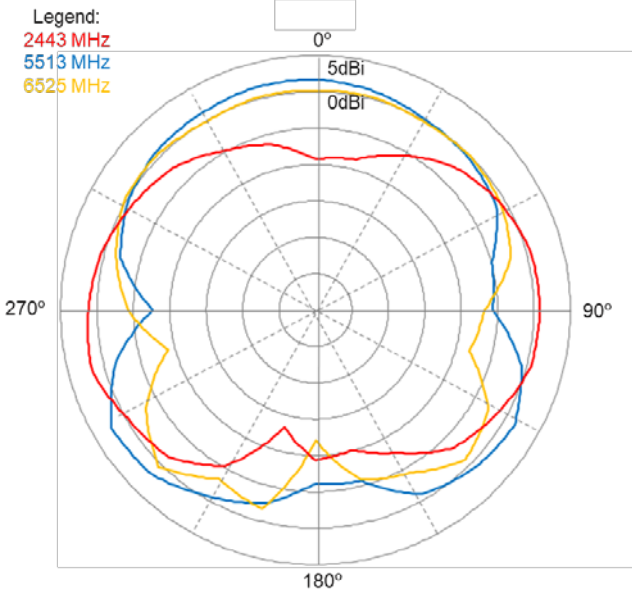

Elevation 2

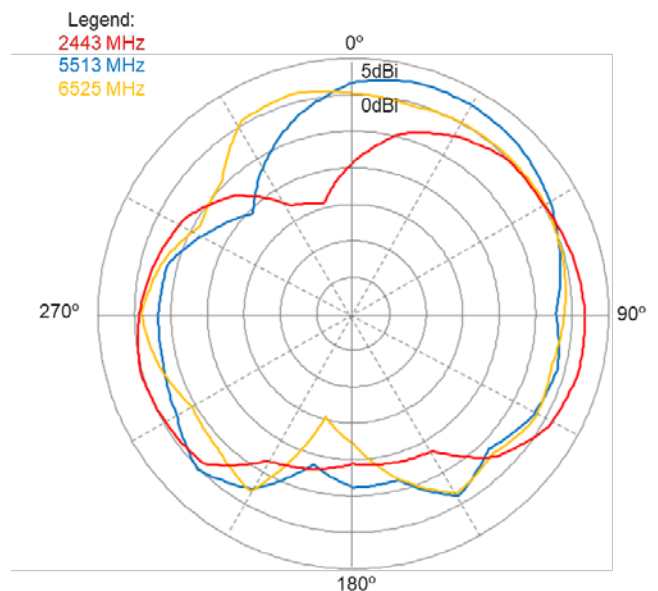

Data measured in free space and on reference ground plane of 33 mm length and 35 mm width, application data might vary

Wi-Fi 6/ 6E TRIPLE BAND ON BOARD ANTENNA

Standard Antenna Solutions

MOUNTING GUIDE

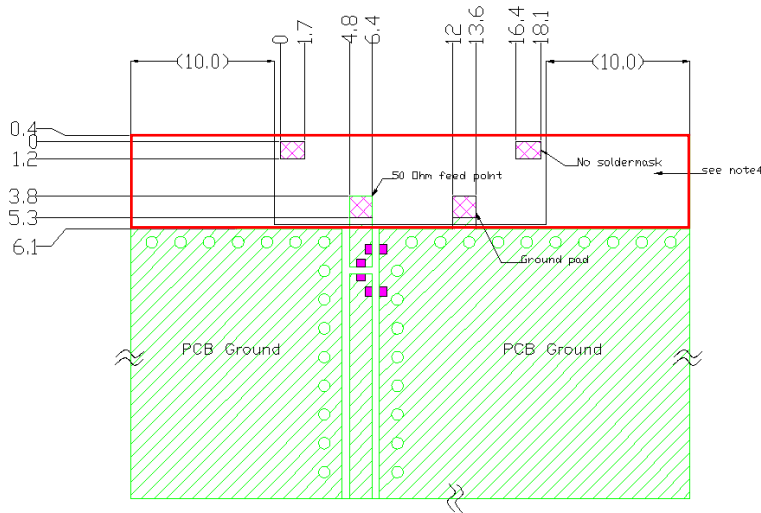

Dimension: mm
Diagrams is not into scale

- NOTES: 1. Suggested matching component pads if device specific tuning needed by either components and materials at close proximity or different ground plane size and layout
 2. Antenna must be mounted on the edge of PCB.
 3. NC = No connection (mechanical mounting pads).
 4. No copper allowed in designated area on all PCB layers –
 5. For more information please call TE.

KEEP OUT AREA

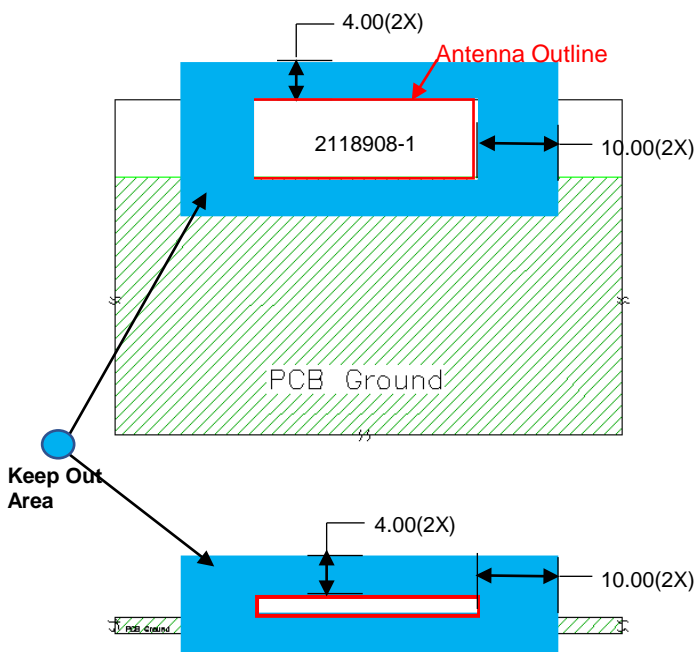

Dimension: mm
Diagrams is not into scale

DIMENSIONS

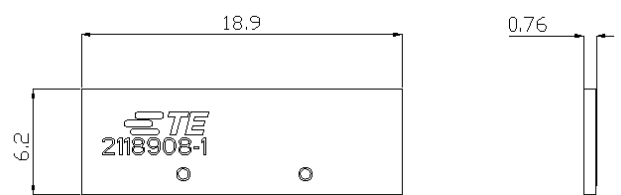

Dimension: mm
Diagrams is not into scale

Wi-Fi 6/ 6E TRIPLE BAND ON BOARD ANTENNA

Standard Antenna Solutions

PACKAGING

2118908-1 (BULK)

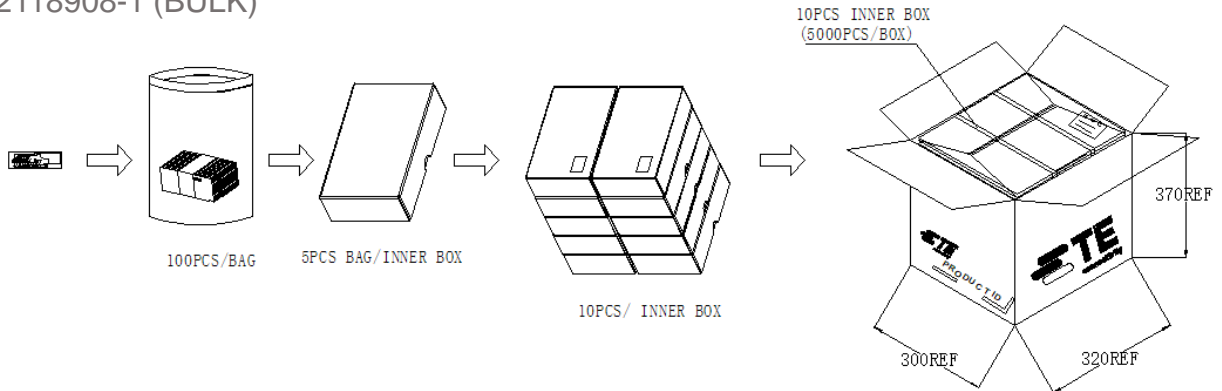

2118908-2 (TAPE & REEL)

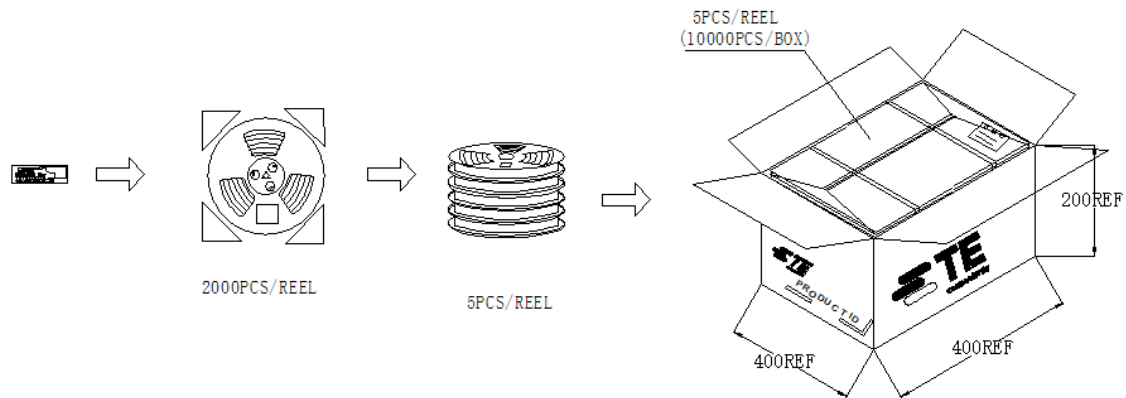

TE TECHNICAL SUPPORT CENTER

USA:	+1 (800) 522-6752
Canada:	+1 (905) 475-6222
Mexico:	+52 (0) 55-1106-0800
Latin/S. America:	+54 (0) 11-4733-2200
Germany:	+49 (0) 6251-133-1999
UK:	+44 (0) 800-267666
France:	+33 (0) 1-3420-8686
Netherlands:	+31 (0) 73-6246-999
China:	+86 (0) 400-820-6015

For phone numbers in other countries, go to te.com/support-center

te.com

TE Connectivity, TE Connectivity (logo) are trademarks. All other logos, products and/or company names referred to herein might be trademarks of their respective owners.

The information given herein, including drawings, illustrations and schematics which are intended for illustration purposes only, is believed to be reliable. However, TE Connectivity makes no warranties as to its accuracy or completeness and disclaims any liability in connection with its use. TE Connectivity's obligations shall only be as set forth in TE Connectivity's Standard Terms and Conditions of Sale for this product and in no case will TE Connectivity be liable for any incidental, indirect or consequential damages arising out of the sale, resale, use or misuse of the product. Users of TE Connectivity products should make their own evaluation to determine the suitability of each such product for the specific application.

© 2020 TE Connectivity Ltd. family of companies All Rights Reserved.

06/2022

单击下面可查看定价，库存，交付和生命周期等信息

[>>TE Connectivity\(泰科\)](#)