

LOC		DIST		REVISIONS			
P	LTN	DESCRIPTION	DATE	DWN	APVD		
A		REVISED PER ECO-12-018201	11OCT2012	KH	MH		

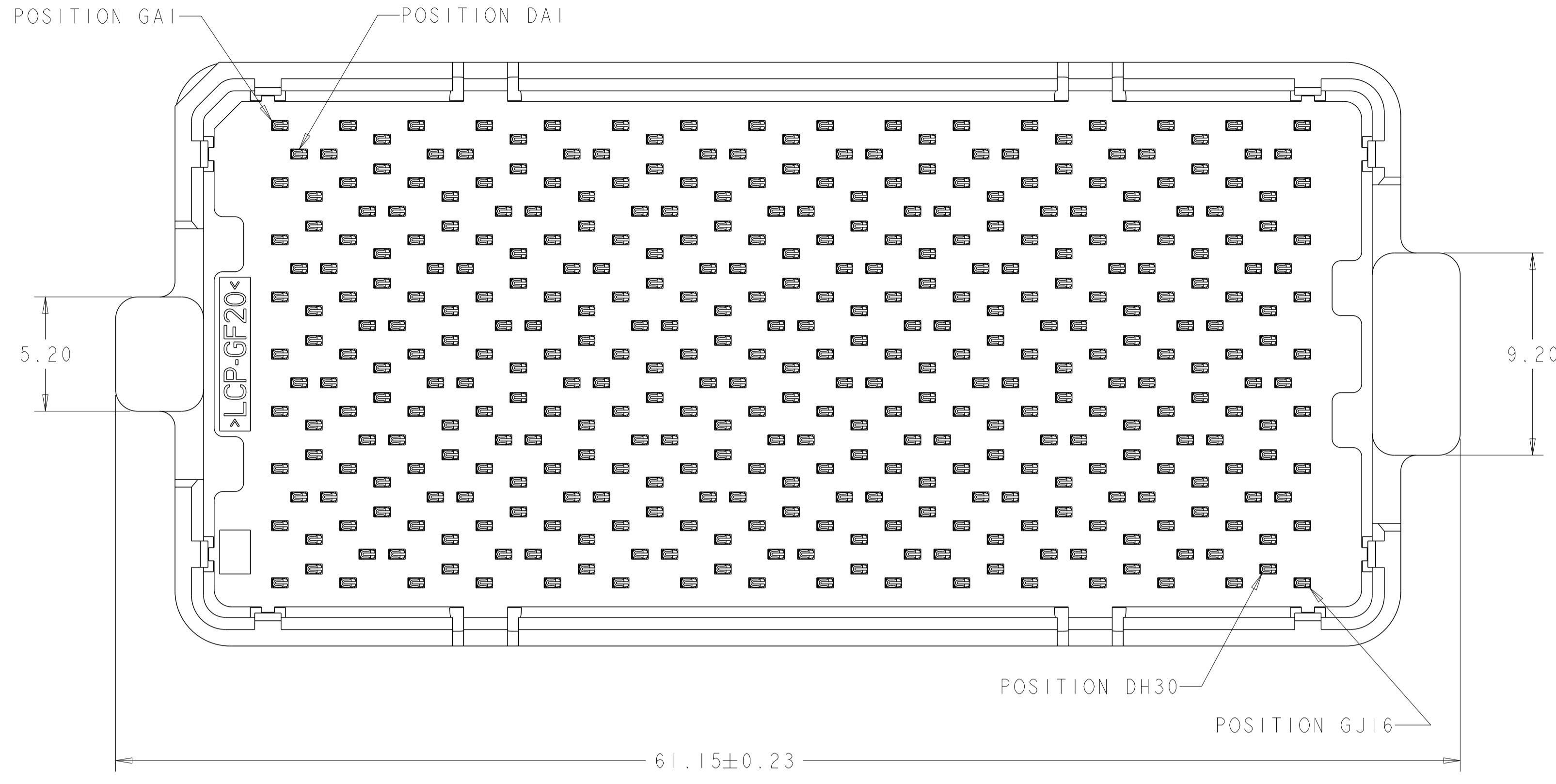

- 1 MATERIAL:
 BASE HOUSING, UPPER HOUSING, ORGANIZER,
 AND SPACER: THERMOPLASTIC, FLAMMABILITY
 RATING UL94-V0
 CONTACT: COPPER ALLOY
- 2. CONFORMS TO THE REQUIREMENTS OF TE PRODUCT
 SPECIFICATION, 108-2375; BASED ON TELCORDIA
 GR-1217-CORE FOR SYSTEM QUALITY LEVEL III,
 APPLICATIONS IN CONTROLLED ENVIRONMENTS
 (CENTRAL OFFICE).
 SEE TE PRODUCT SPECIFICATION 108-2375 FOR
 TEST SEQUENCES.
- 3 ROWS GA THRU GJ (SHOWN DARKENED) ARE TYPICALLY
 USED AS GROUNDS.
- 4 SPECIFIED POSITIONAL TOLERANCE DEFINES HOLE TO
 HOLE LOCATION WITHIN HOLE PATTERN. POSITIONAL
 TOLERANCE OF HOLE PATTERN TO FIDUCIAL MARKS
 OR PCB DATUMS SHALL BE DEFINED BY CUSTOMER.
- 5 AREA RESERVED FOR TE CONNECTIVITY LOGO.
- 6 AREA RESERVED FOR PART NUMBER (X-XXXXXX-X)
 AND DATE CODE (YYWW).
- 7 USE CENTERLINES INDICATED ON PCB HOLE PATTERN
 TO ESTABLISH ALIGNMENT BETWEEN HEADER AND
 RECEPTACLE BOARDS.
- 8 PLATED THROUGH HOLE REQUIREMENTS:
 HOLE SIZE PRIOR TO PLATING = $\varnothing 0.420 \pm 0.013$
 COPPER PLATING THICKNESS = 0.038 ± 0.013
 CALCULATED FINISHED HOLE SIZE = $\varnothing 0.344 \pm 0.039$
 THESE DIMENSIONS APPLY TO THE TOP 1.25mm OF
 THE PCB THICKNESS FROM THE CONNECTOR MOUNTING
 SIDE.
- 9 CONTACT SALES FOR AVAILABILITY OF THIS STACK
 HEIGHT.

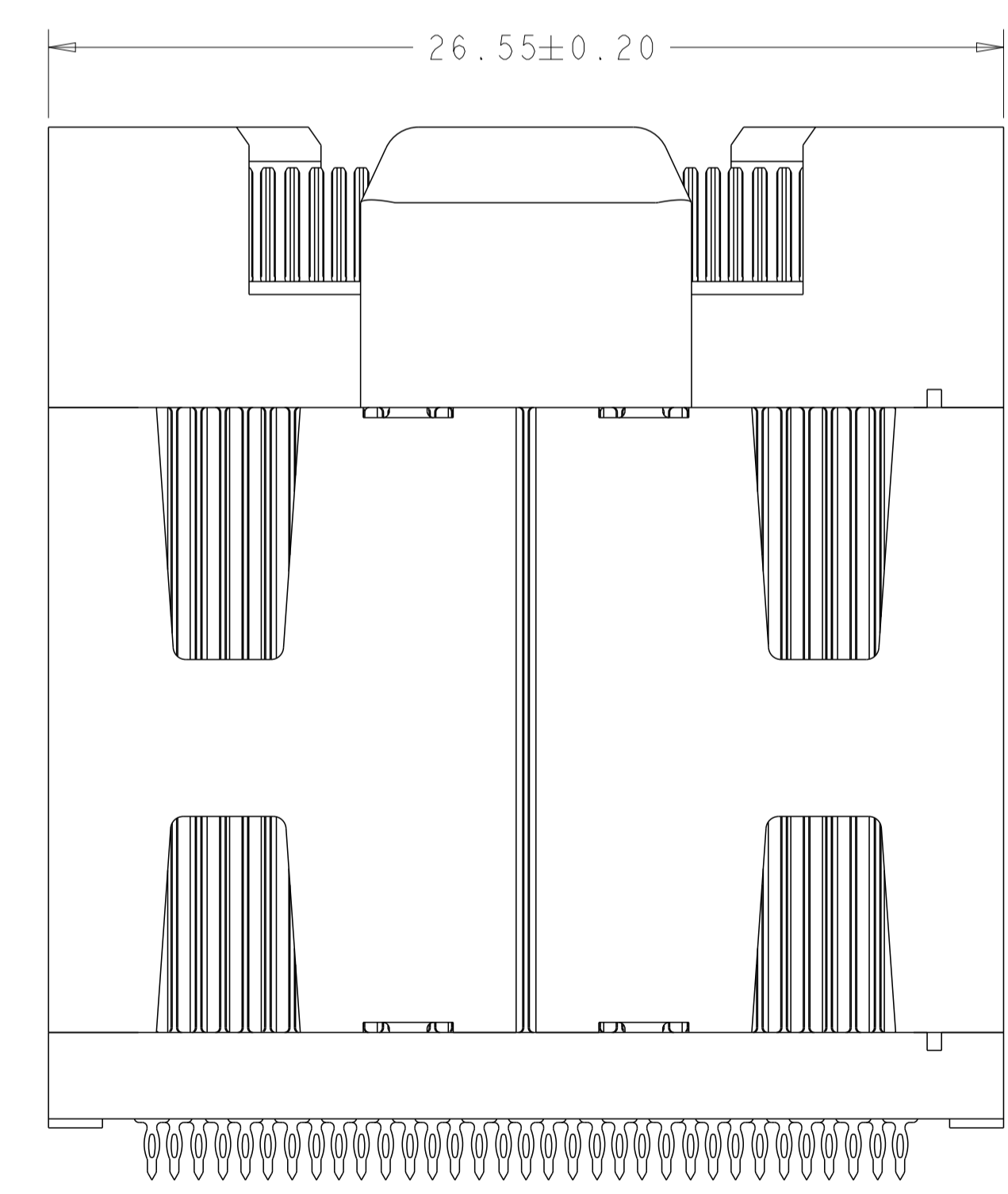
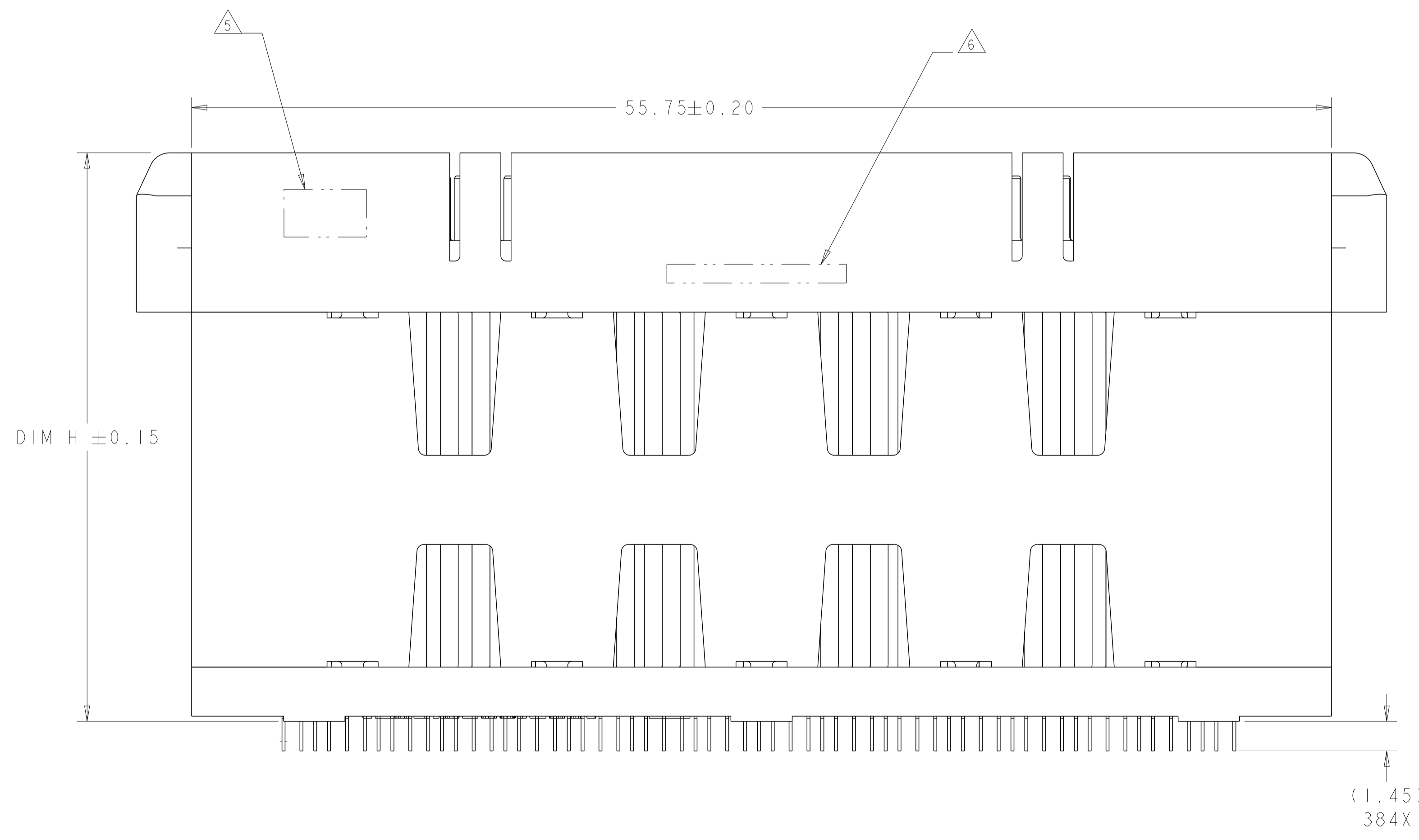

SIZE 3 HOUSING W/ GUIDE POSTS *
120 DIFFERENTIAL PAIRS
384 TOTAL SIGNAL CONTACTS

* SIZE 1 AND SIZE 2 ARE ALSO AVAILABLE

THIS DRAWING IS A CONTROLLED DOCUMENT.		DWN D. RINGLER 20JAN2010	TE Connectivity	
DIMENSIONS:		CHK D. TROUT 20JAN2010		
TOLERANCES UNLESS OTHERWISE SPECIFIED:		APVD J. FEEDER 20JAN2010	NAME HEADER ASSEMBLY	
mm		PRODUCT SPEC	120/384	
0 PLC ±		APPLICATION SPEC	STRADA MESA MEZZANINE CONNECTOR	
2 PLC ±0.13		SIZE	A1	
3 PLC ±0.013		WEIGHT	C=2132790	
4 PLC ±		SCALE	6:1	
ANGLES ±1		SHEET	1 OF 4	
FINISH		REV	A	
MATERIAL		CUSTOMER DRAWING		

LOC	DIST	REVISIONS					
		P	LYR	DESCRIPTION	DATE	OWN	APVD
GP	00	-	-	SEE SHEET 1	-	-	-

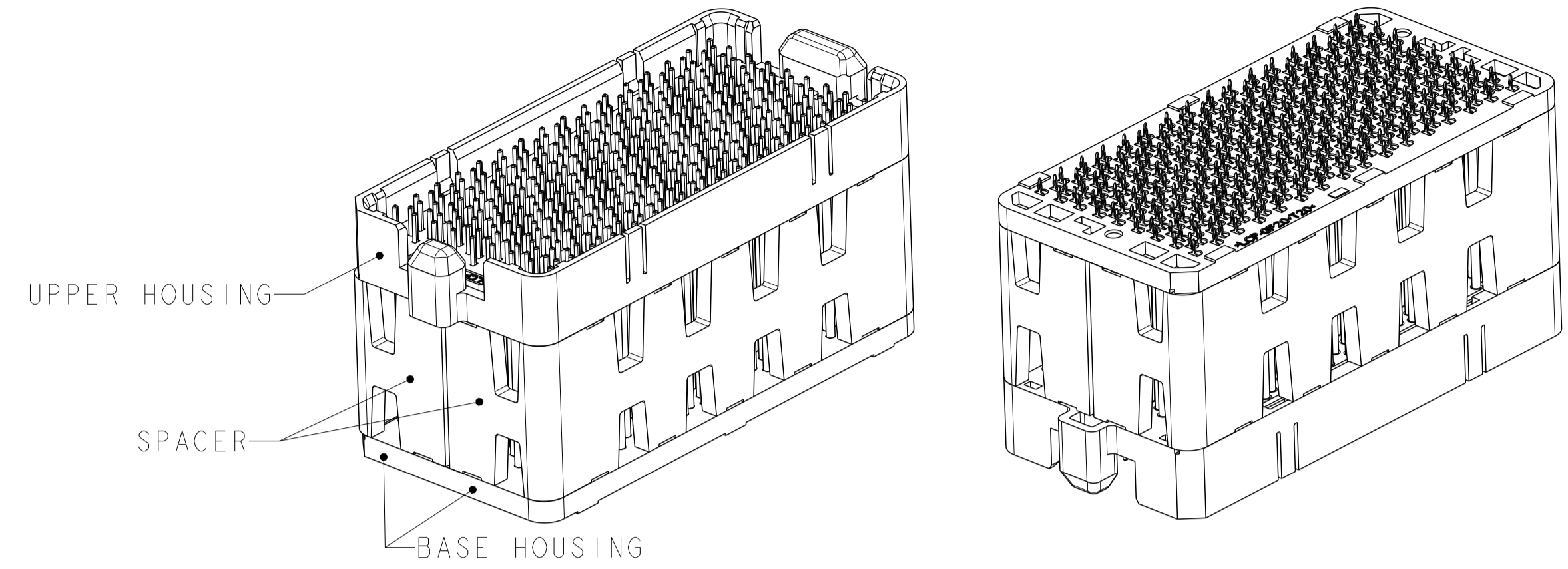

ISOMETRIC VIEW
 TYPICAL CONFIGURATION FOR 14mm THRU 42mm
 28mm SHOWN
 SCALE 2:1

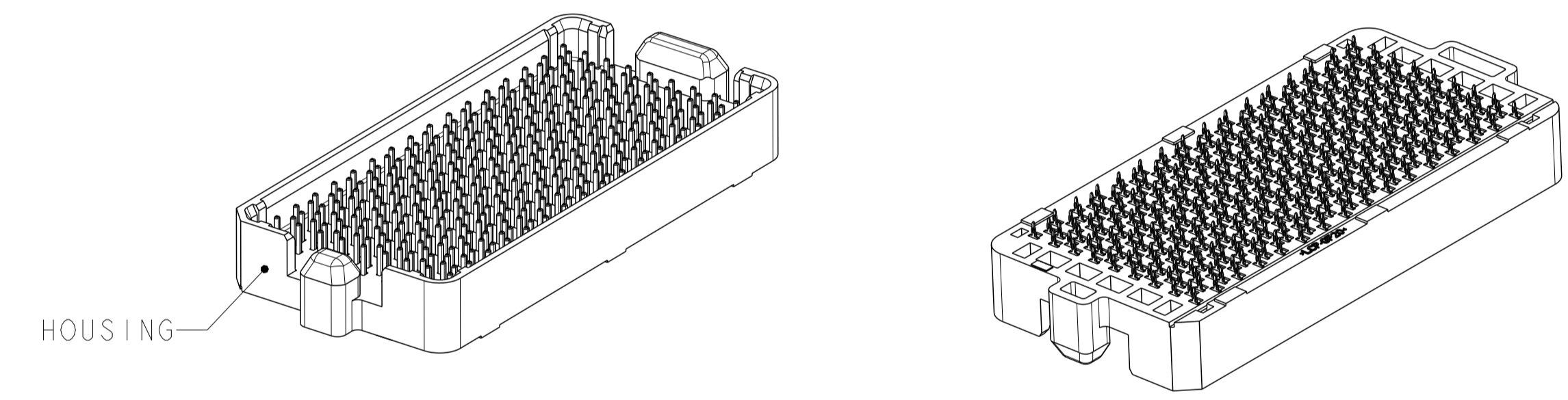

ISOMETRIC VIEWS
 TYPICAL CONFIGURATION FOR 8mm THRU 13mm
 8mm SHOWN
 SCALE 2:1

△	41.8	42mm	MATTE Sn	9-2132790-2
△	40.8	41mm	MATTE Sn	9-2132790-1
YES	39.8	40mm	MATTE Sn	9-2132790-0
△	38.8	39mm	MATTE Sn	8-2132790-9
△	37.8	38mm	MATTE Sn	8-2132790-8
△	36.8	37mm	MATTE Sn	8-2132790-7
△	35.8	36mm	MATTE Sn	8-2132790-6
△	34.8	35mm	MATTE Sn	8-2132790-5
△	33.8	34mm	MATTE Sn	8-2132790-4
△	32.8	33mm	MATTE Sn	8-2132790-3
△	31.8	32mm	MATTE Sn	8-2132790-2
△	30.8	31mm	MATTE Sn	8-2132790-1
△	29.8	30mm	MATTE Sn	8-2132790-0
△	28.8	29mm	MATTE Sn	7-2132790-9
YES	27.8	28mm	MATTE Sn	7-2132790-8
△	26.8	27mm	MATTE Sn	7-2132790-7
△	25.8	26mm	MATTE Sn	7-2132790-6
△	24.8	25mm	MATTE Sn	7-2132790-5
△	23.8	24mm	MATTE Sn	7-2132790-4
YES	22.8	23mm	MATTE Sn	7-2132790-3
△	21.8	22mm	MATTE Sn	7-2132790-2
△	20.8	21mm	MATTE Sn	7-2132790-1
△	19.8	20mm	MATTE Sn	7-2132790-0
△	18.8	19mm	MATTE Sn	6-2132790-9
△	17.8	18mm	MATTE Sn	6-2132790-8
△	16.8	17mm	MATTE Sn	6-2132790-7
△	15.8	16mm	MATTE Sn	6-2132790-6
△	14.8	15mm	MATTE Sn	6-2132790-5
△	13.8	14mm	MATTE Sn	6-2132790-4
△	12.8	13mm	MATTE Sn	6-2132790-3
△	11.8	12mm	MATTE Sn	6-2132790-2
△	10.8	11mm	MATTE Sn	6-2132790-1
YES	9.8	10mm	MATTE Sn	6-2132790-0
△	8.8	9mm	MATTE Sn	5-2132790-9
△	7.8	8mm	MATTE Sn	5-2132790-8
TOOLED	DIM H	STACK HEIGHT	CONTACT TAIL PLATING	PART NUMBER

△	41.8	42mm	Sn/Pb	4-2132790-2
△	40.8	41mm	Sn/Pb	4-2132790-1
YES	39.8	40mm	Sn/Pb	4-2132790-0
△	38.8	39mm	Sn/Pb	3-2132790-9
△	37.8	38mm	Sn/Pb	3-2132790-8
△	36.8	37mm	Sn/Pb	3-2132790-7
△	35.8	36mm	Sn/Pb	3-2132790-6
△	34.8	35mm	Sn/Pb	3-2132790-5
△	33.8	34mm	Sn/Pb	3-2132790-4
△	32.8	33mm	Sn/Pb	3-2132790-3
△	31.8	32mm	Sn/Pb	3-2132790-2
△	30.8	31mm	Sn/Pb	3-2132790-1
△	29.8	30mm	Sn/Pb	3-2132790-0
△	28.8	29mm	Sn/Pb	2-2132790-9
YES	27.8	28mm	Sn/Pb	2-2132790-8
△	26.8	27mm	Sn/Pb	2-2132790-7
△	25.8	26mm	Sn/Pb	2-2132790-6
△	24.8	25mm	Sn/Pb	2-2132790-5
△	23.8	24mm	Sn/Pb	2-2132790-4
YES	22.8	23mm	Sn/Pb	2-2132790-3
△	21.8	22mm	Sn/Pb	2-2132790-2
△	20.8	21mm	Sn/Pb	2-2132790-1
△	19.8	20mm	Sn/Pb	2-2132790-0
△	18.8	19mm	Sn/Pb	1-2132790-9
△	17.8	18mm	Sn/Pb	1-2132790-8
△	16.8	17mm	Sn/Pb	1-2132790-7
△	15.8	16mm	Sn/Pb	1-2132790-6
△	14.8	15mm	Sn/Pb	1-2132790-5
△	13.8	14mm	Sn/Pb	1-2132790-4
△	12.8	13mm	Sn/Pb	1-2132790-3
△	11.8	12mm	Sn/Pb	1-2132790-2
△	10.8	11mm	Sn/Pb	1-2132790-1
YES	9.8	10mm	Sn/Pb	1-2132790-0
△	8.8	9mm	Sn/Pb	2132790-9
△	7.8	8mm	Sn/Pb	2132790-8
TOOLED	DIM H	STACK HEIGHT	CONTACT TAIL PLATING	PART NUMBER

THIS DRAWING IS A CONTROLLED DOCUMENT.

DIMENSIONS: mm
 TOLERANCES UNLESS OTHERWISE SPECIFIED:
 0 PLC ±
 1 PLC ±0.13
 2 PLC ±0.13
 3 PLC ±0.13
 4 PLC ±
 ANGLES ±1
 FINISH

DWG: D. RINGLER 20JAN2010
 CHK: D. TROUT 20JAN2010
 APVD: J. FEEDER 20JAN2010

NAME: HEADER ASSEMBLY
 120/384
 STRADA MESA MEZZANINE CONNECTOR

SIZE: A1
 CAGE CODE: 108-2375
 DRAWING NO: 114-13249
 WEIGHT: -
 CUSTOMER DRAWING

DATE: 20JAN2010
 SCALE: 6:1
 SHEET: 2 OF 4
 REV: A

STE TE Connectivity

LOC	DIST	REVISIONS			
P	LTN	DESCRIPTION	DATE	DWN	APVD
-	-	SEE SHEET 1	-	-	-

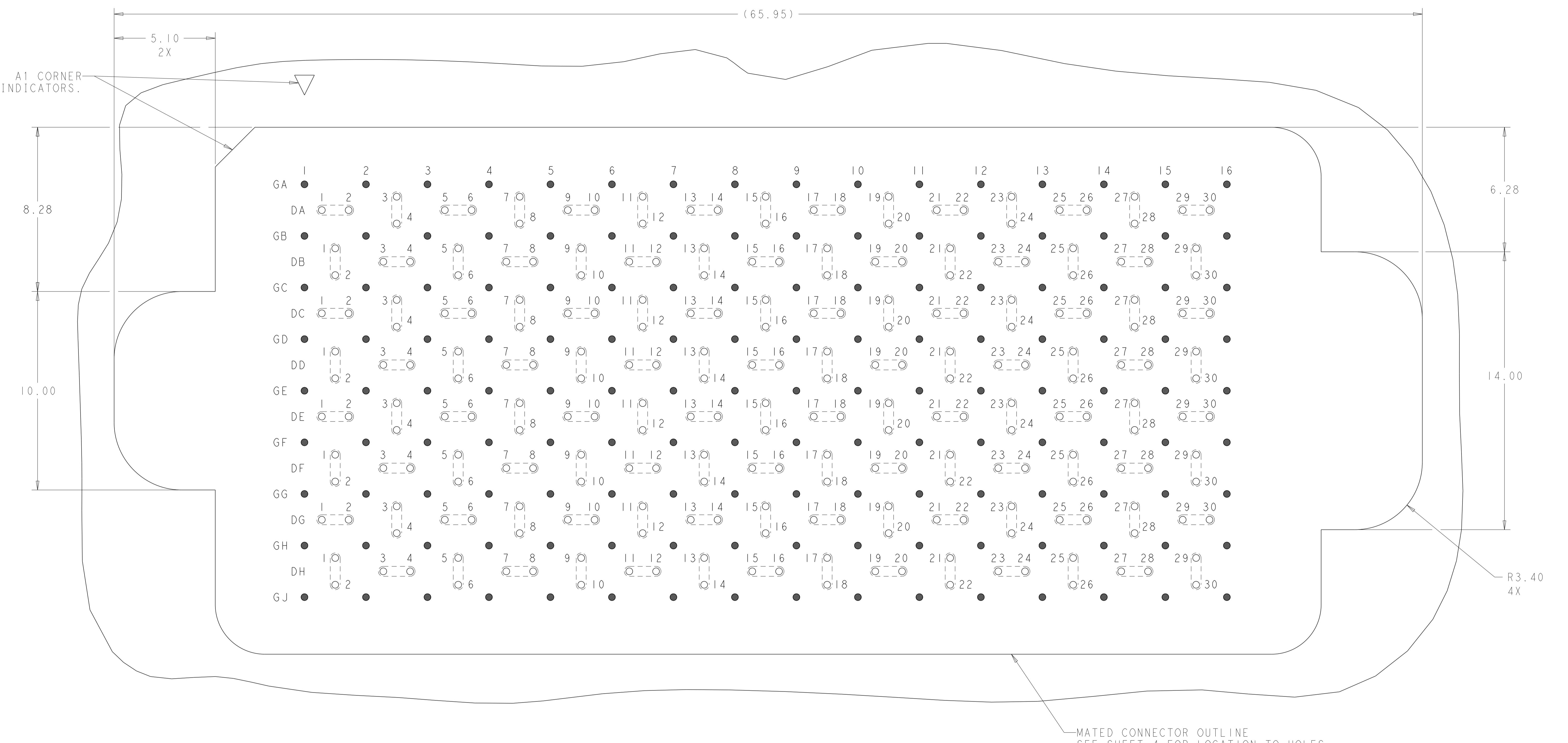

PCB LAYOUT AND PIN IDENTIFICATION 
 SHOWN FROM CONNECTOR SIDE
 SCALE 10:1

THIS DRAWING IS A CONTROLLED DOCUMENT.		DWN D. RINGLER 20JAN2010	 TE Connectivity
DIMENSIONS: mm		CHK D. TROUT 20JAN2010	
TOLERANCES UNLESS OTHERWISE SPECIFIED:		APVD J. FEEDER 20JAN2010	NAME HEADER ASSEMBLY 120/384
0 PLC ± 2 PLC ±0.13 3 PLC ±0.013 4 PLC ± ANGLES ±1		PRODUCT SPEC 108-2375	RESTRICTED TO
MATERIAL		APPLICATION SPEC 114-13249	SIZE A100779
FINISH		WEIGHT	CAGE CODE C=2132790
CUSTOMER DRAWING		SCALE 6:1	SHEET 3 OF 4
		REV A	

单击下面可查看定价，库存，交付和生命周期等信息

[>>TE Connectivity\(泰科\)](#)