

THIS DRAWING IS UNPUBLISHED. RELEASED FOR PUBLICATION  
 © COPYRIGHT - BY TYCO ELECTRONICS CORPORATION. ALL RIGHTS RESERVED.

| LOC | DIST | REVISIONS   |                                    |           |          |
|-----|------|-------------|------------------------------------|-----------|----------|
| P   | LTR  | DESCRIPTION | DATE                               | DWN       | APVD     |
| H   | -    | A           | DRAWING RELEASED PER ECR-11-017294 | 22AUG2011 | JvdH TdB |

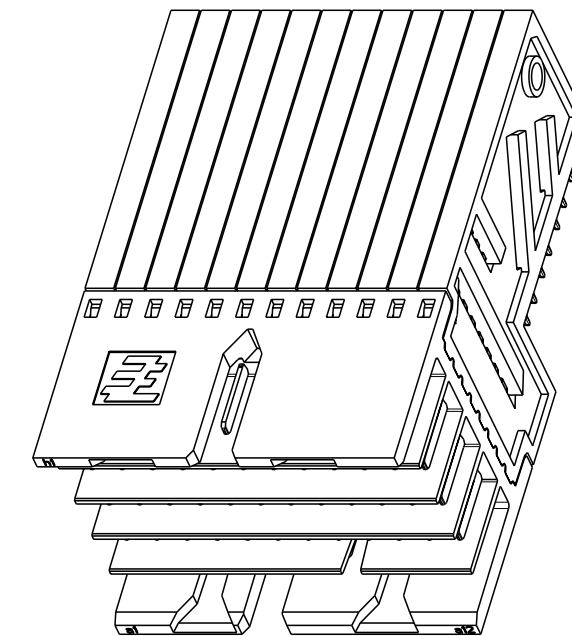

SCALE 3:1

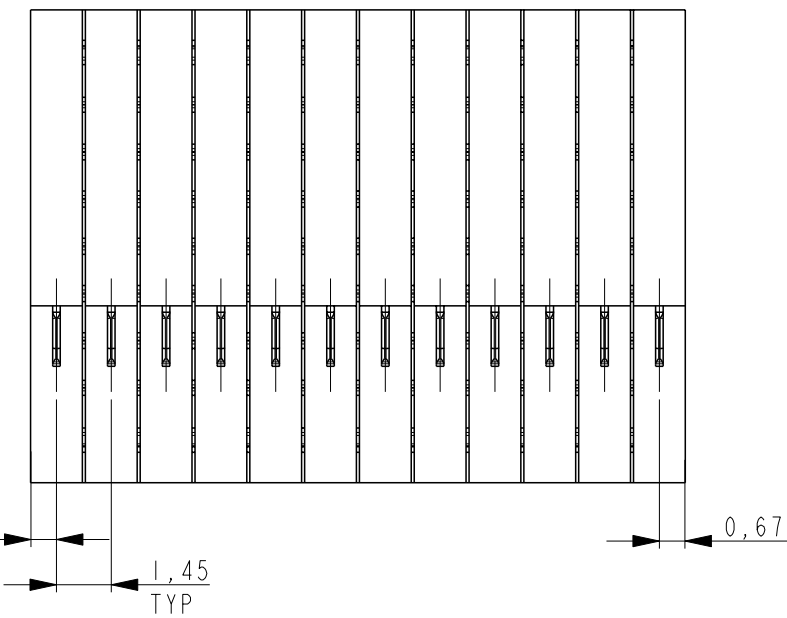
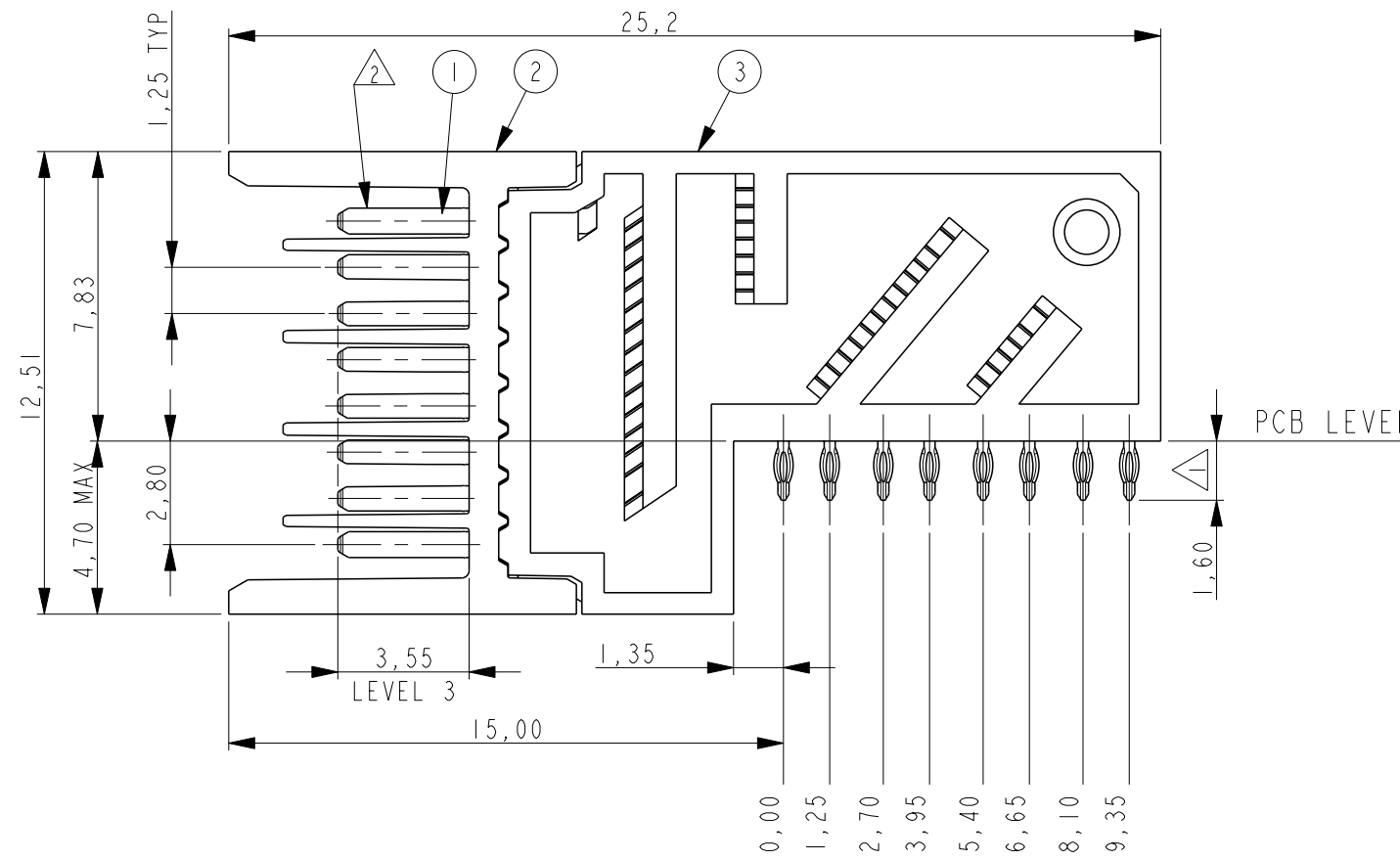
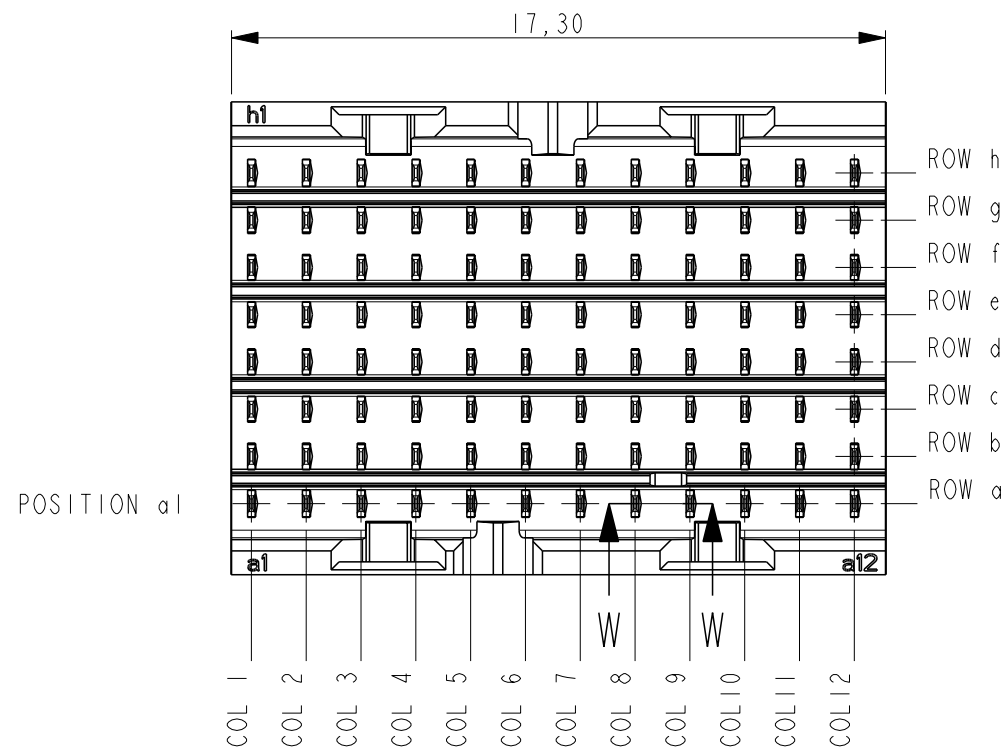
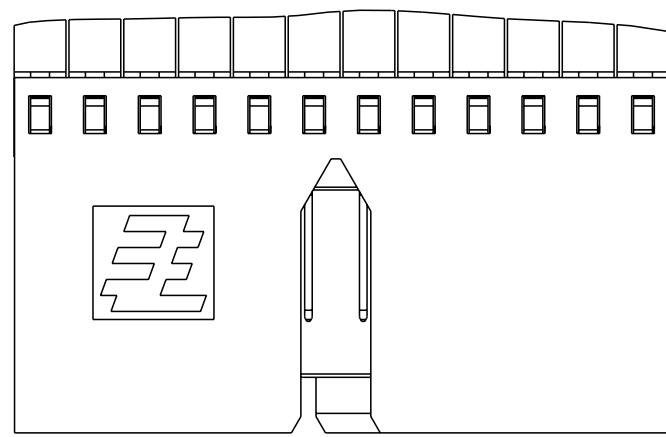
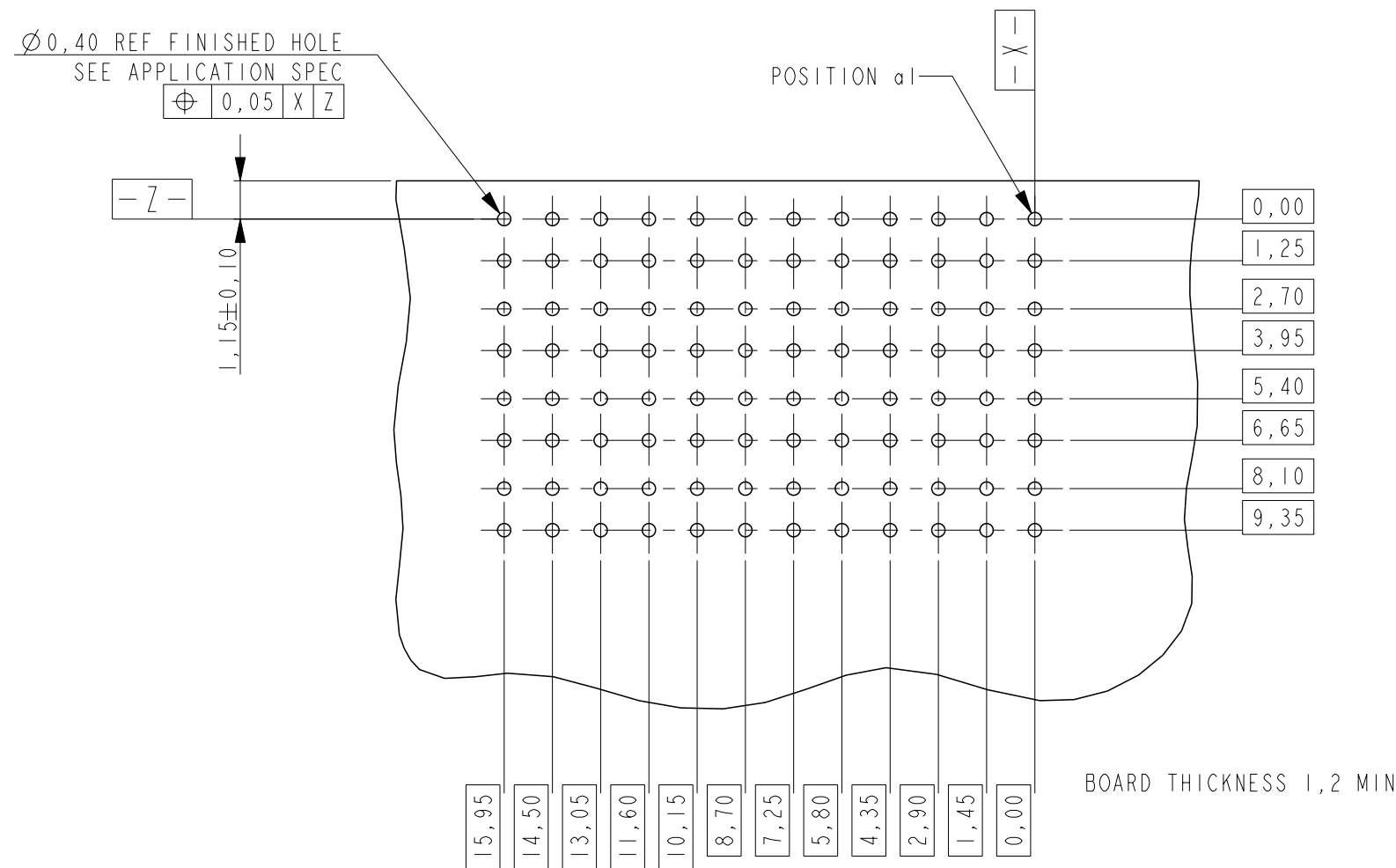
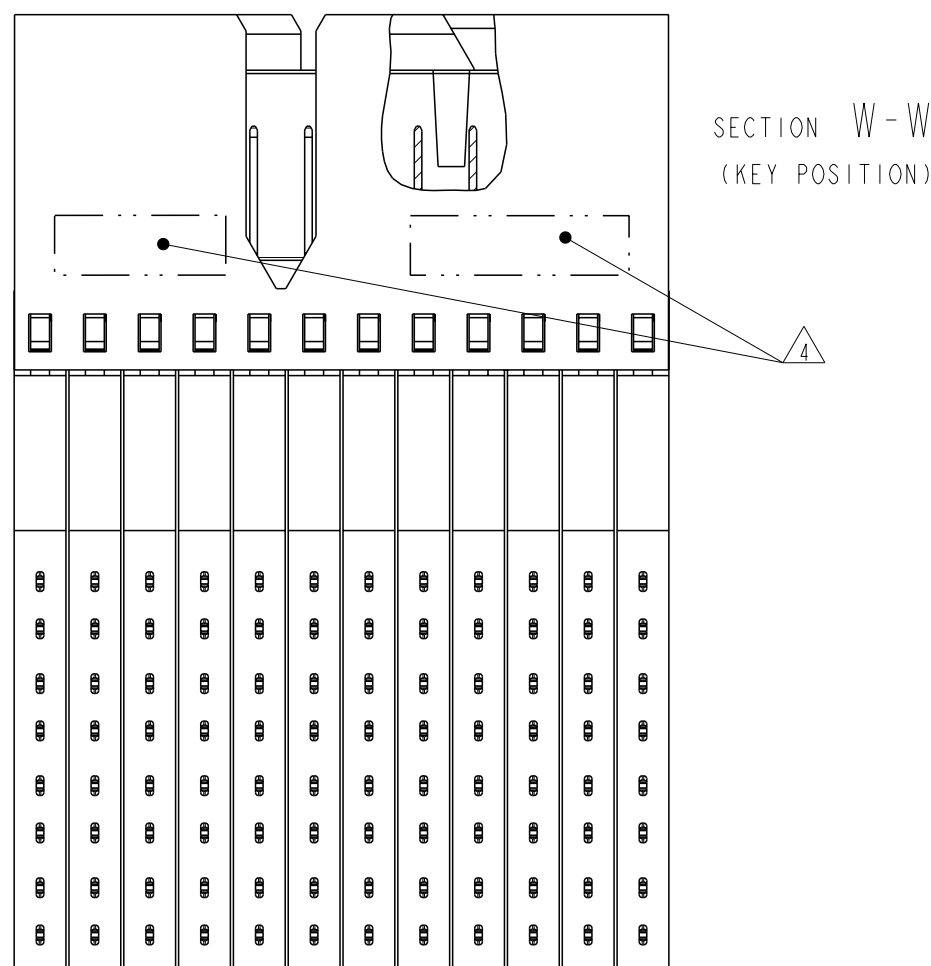

**PRODUCT HAS NOT COMPLETED QUALIFICATION TESTING**

NOTES:

- △ PLATING: 0,5µm MIN. TIN OVER NICKEL.
- △ PLATING:

| PARTNUMBER | PERFORMANCE LEVEL                                                                                                                                                       |
|------------|-------------------------------------------------------------------------------------------------------------------------------------------------------------------------|
| 2042139-1  | PERFORMANCE LEVEL 1: CONNECTOR TESTED AND QUALIFIED AGAINST TELCORDIA GR-1217-CORE QUALITY LEVEL 111: UNCONTROLLED ENVIRONMENT APPLICATIONS. SEE PRODUCT SPEC 108-19353 |
| 2042139-2  | PERFORMANCE LEVEL 2: CONFORMS TO ALL TESTING ACCORDING PRODUCT SPEC 108-19320, -250 MATING CYCLES, 4 DAYS MIXED GAS TEST PER IEC 60068-2-60 METHOD 1                    |

- 3 CONSULT APPLICATION SPEC OR CONTACT TE CONNECTIVITY FOR PERMISSIBLE CONTACT ASSIGNMENTS.
- △ CONNECTOR MARKED WITH PARTNUMBER AND DATE CODE.
- 5 FOR PC-BOARD ROUTING RECOMMENDATIONS SEE SPEC 114-19140

RECOMMENDED PCB LAYOUT (COMPONENT SIDE SHOWN)

|                                        |  |                  |
|----------------------------------------|--|------------------|
| THIS DRAWING IS A CONTROLLED DOCUMENT. |  | DWN RA 15-Apr-09 |
| DIMENSIONS: mm                         |  | CHK RA 15-Apr-09 |
| TOLERANCES UNLESS OTHERWISE SPECIFIED: |  | APVD -           |
| 0 PLC ±                                |  | PRODUCT SPEC     |
| 1 PLC ±                                |  | SEE NOTE △       |
| 2 PLC ±                                |  | APPLICATION SPEC |
| 3 PLC ±                                |  | 114-19106        |
| 4 PLC ±                                |  | WEIGHT -         |
| ANGLES ±                               |  | CUSTOMER DRAWING |
| FINISH                                 |  |                  |

|          |             |                    |
|----------|-------------|--------------------|
| ITEM NO. | DESCRIPTION | MATERIAL           |
| 3        | OVERMOLD    | PBT 20% GF GREY    |
| 2        | HOUSING     | LCP 30% GF NATURAL |
| 1        | CONTACT     | COPPER ALLOY       |

|           |           |                                                         |               |
|-----------|-----------|---------------------------------------------------------|---------------|
| NAME      |           | RIGHT ANGLE MALE CONNECTOR Z-PACK Slim UHD Common Speed |               |
| SIZE      | CAGE CODE | DRAWING NO                                              | RESTRICTED TO |
| A2        | 00779     | 2042139                                                 | -             |
| SCALE 5:1 |           | SHEET 1 OF 1                                            | REV A         |

单击下面可查看定价，库存，交付和生命周期等信息

[>>TE Connectivity\(泰科\)](#)