

THIS DRAWING IS UNPUBLISHED.

RELEASED FOR PUBLICATION

---

© COPYRIGHT - By -

ALL RIGHTS RESERVED.

LOC	DIST	REVISIONS					
E	B	P	LTR	DESCRIPTION	DATE	DWN	APVD
			A1	REVISED PER ECO-11-005150	21MAR11	RK	HMR

NOTES:

- ELECTRICAL DATA: CONTACT RESISTANCE: 10 mOhm MAX  
INSULATION RESISTANCE: 100 MOhm MIN at 500VDC  
CURRENT RATING: 5 AMPS (FOR 3, 4 AND 5 POSITIONS) AND 2 AMPS (FOR 8 POSITION ONLY)  
BREAKDOWN VOLTAGE: 500 VAC MIN PER MINUTE
- ENVIRONMENTAL: OPERATING TEMPERATURE: -25°C TO +90°C  
SEALING REQUIREMENTS: IP67
- PROD SPEC: 108-3641
- PACKAGING: 107-3334
- FOR TECHNICAL DATA REFER TO YOUR LOCAL TE CONNECTIVITY SALES OFFICE.
- ALL DIMENSIONS ARE NOMINAL FOR REFERENCE ONLY UNLESS OTHERWISE STATED.

ITEM	DESCRIPTION	MATERIAL	FINISH/COLOUR	QUANTITY / ITEM			
				-1	-2	-3	-4
1	CONNECTOR HOUSING	GF NYLON	BLACK	1	1	1	1
2	PIN CONTACT	BRASS	0.15µm GOLD OVER NICKEL	3	4	5	8
3	CONNECTOR BODY	BRASS	NICKEL PLATED	1	1	1	1
4	'O' RING	EPDM	BLACK	1	1	1	1
5	SCREW NUT	BRASS	0.25µm NICKEL PLATED	1	1	1	1

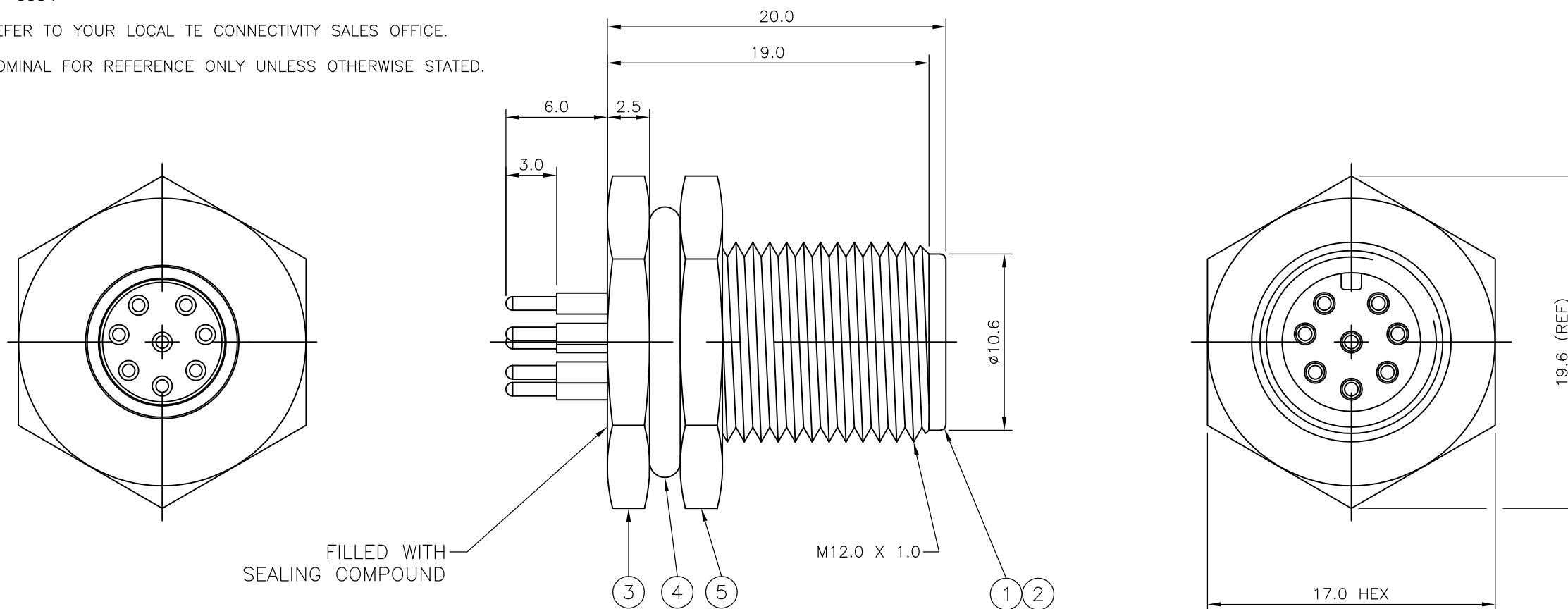

FILLED WITH SEALING COMPOUND

M12.0 X 1.0

M12 METAL MALE PANEL MOUNT CONNECTOR, PCB, STRAIGHT, FRONT (HEXAGONAL) MOUNTING	8	1838420-4
M12 METAL MALE PANEL MOUNT CONNECTOR, PCB, STRAIGHT, FRONT (HEXAGONAL) MOUNTING	5	1838420-3
M12 METAL MALE PANEL MOUNT CONNECTOR, PCB, STRAIGHT, FRONT (HEXAGONAL) MOUNTING	4	1838420-2
M12 METAL MALE PANEL MOUNT CONNECTOR, PCB, STRAIGHT, FRONT (HEXAGONAL) MOUNTING	3	1838420-1
DESCRIPTION	NO. OF POS	PART NUMBER

THIS DRAWING IS A CONTROLLED DOCUMENT.		DWN A.Morey 8MAR06	<b>STE</b> TE Connectivity	
DIMENSIONS: mm		CHK F.Wheeler-King 12APR06		
TOLERANCES UNLESS OTHERWISE SPECIFIED:		APVD F.Wheeler-King 12APR06	NAME M12 METAL MALE PANEL MOUNT CONNECTOR, SOLDER, STRAIGHT, FRONT (HEXAGONAL) MOUNTING	
0 PLC ± - 1 PLC ± - 2 PLC ± - 3 PLC ± - 4 PLC ± - ANGLES ± -		PRODUCT SPEC -	SIZE A3	
MATERIAL -		FINISH -	CAGE CODE 00779	DRAWING NO C-1838420
		WEIGHT -	RESTRICTED TO -	
CUSTOMER DRAWING			SCALE NTS	SHEET 1 OF 2
			REV A1	

THIS DRAWING IS UNPUBLISHED.

RELEASED FOR PUBLICATION

---

LOC

DIST

REVISIONS

© COPYRIGHT - By -

ALL RIGHTS RESERVED.

E

B

P

LTR

DESCRIPTION

DATE

DWN

APVD

SEE SHEET 1

1838420-1

1838420-2

1838420-3

1838420-4

PIN ASSIGNMENTS  
FRONT VIEW

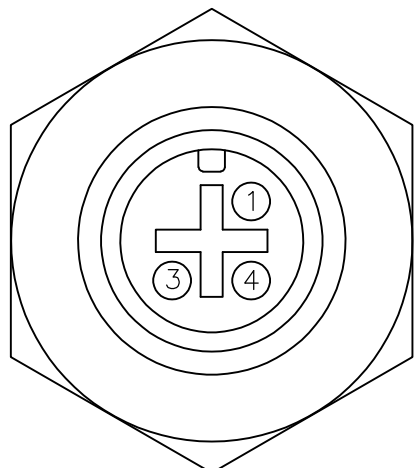

PIN ASSIGNMENTS  
FRONT VIEW

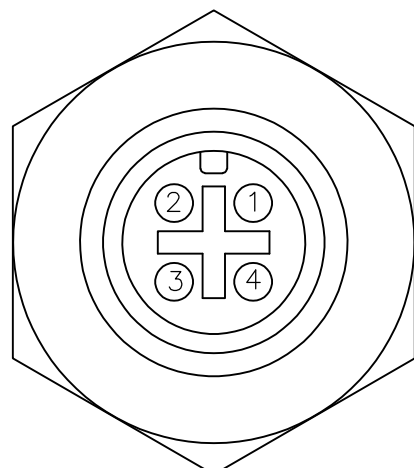

PIN ASSIGNMENTS  
FRONT VIEW

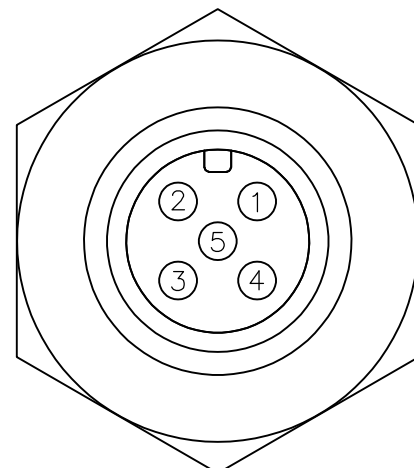

PIN ASSIGNMENTS  
FRONT VIEW

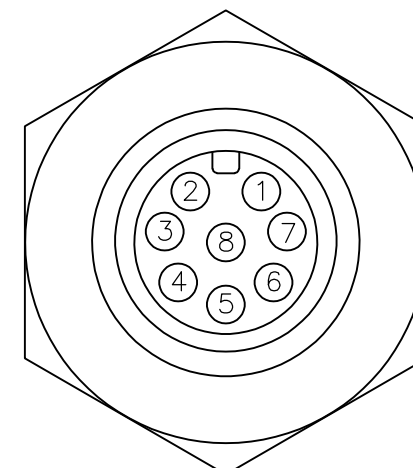

RECOMMENDED PANEL CUT-OUT  
(MAX PANEL THICKNESS 8.0mm)

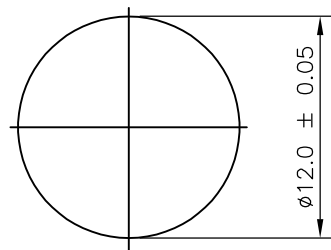

RECOMMENDED PANEL CUT-OUT  
(MAX PANEL THICKNESS 8.0mm)

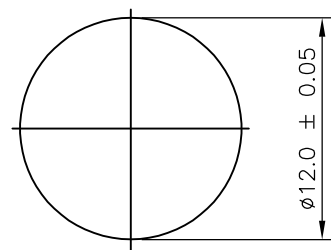

RECOMMENDED PANEL CUT-OUT  
(MAX PANEL THICKNESS 8.0mm)

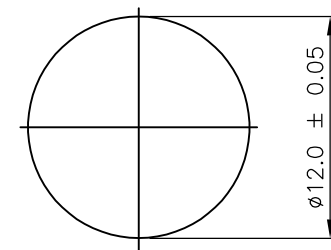

RECOMMENDED PANEL CUT-OUT  
(MAX PANEL THICKNESS 8.0mm)

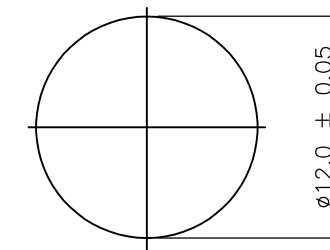

RECOMMENDED  
PCB LAYOUT

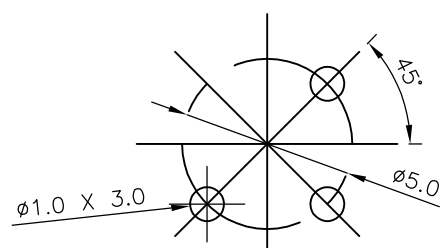

RECOMMENDED  
PCB LAYOUT

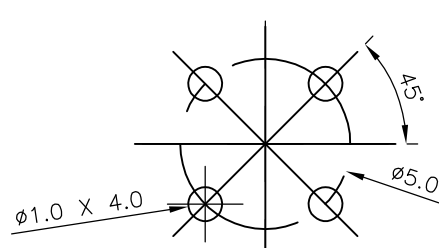

RECOMMENDED  
PCB LAYOUT

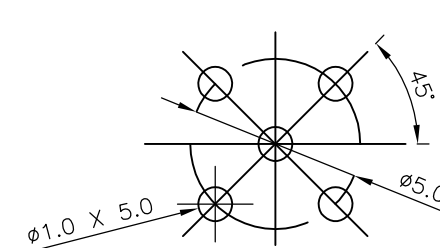

RECOMMENDED  
PCB LAYOUT

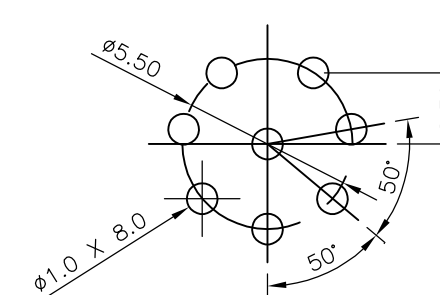

THIS DRAWING IS A CONTROLLED DOCUMENT.

DWN 08MAR06

A. Morey

CHK 12APR06

F. Wheeler-King

APVD 12APR06

F. Wheeler-King

PRODUCT SPEC

APPLICATION SPEC

WEIGHT

CUSTOMER DRAWING

**STE** TE Connectivity

M12 METAL MALE PANEL MOUNT CONNECTOR,  
SOLDER, STRAIGHT, FRONT (CIRCULAR) MOUNTING

SIZE A3 CAGE CODE 00779 DRAWING NO. C-1838420 RESTRICTED TO

SCALE NTS SHEET 2 OF 2 REV A1

DIMENSIONS:

mm

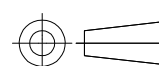

TOLERANCES UNLESS OTHERWISE SPECIFIED:

- 0 PLC ± -
- 1 PLC ± -
- 2 PLC ± -
- 3 PLC ± -
- 4 PLC ± -
- ANGLES ± -
- FINISH -

MATERIAL

-

单击下面可查看定价，库存，交付和生命周期等信息

[>>TE Connectivity\(泰科\)](#)