

THIS DRAWING IS UNPUBLISHED. RELEASED FOR PUBLICATION  
 © COPYRIGHT BY TYCO ELECTRONICS CORPORATION. ALL RIGHTS RESERVED.

LOC		DIST		REVISIONS			
P	LTR	DESCRIPTION	DATE	DWN	APVD		
	C	UPDATE PER ECO-06-004070	21 FEB 06	MJS	MKS		

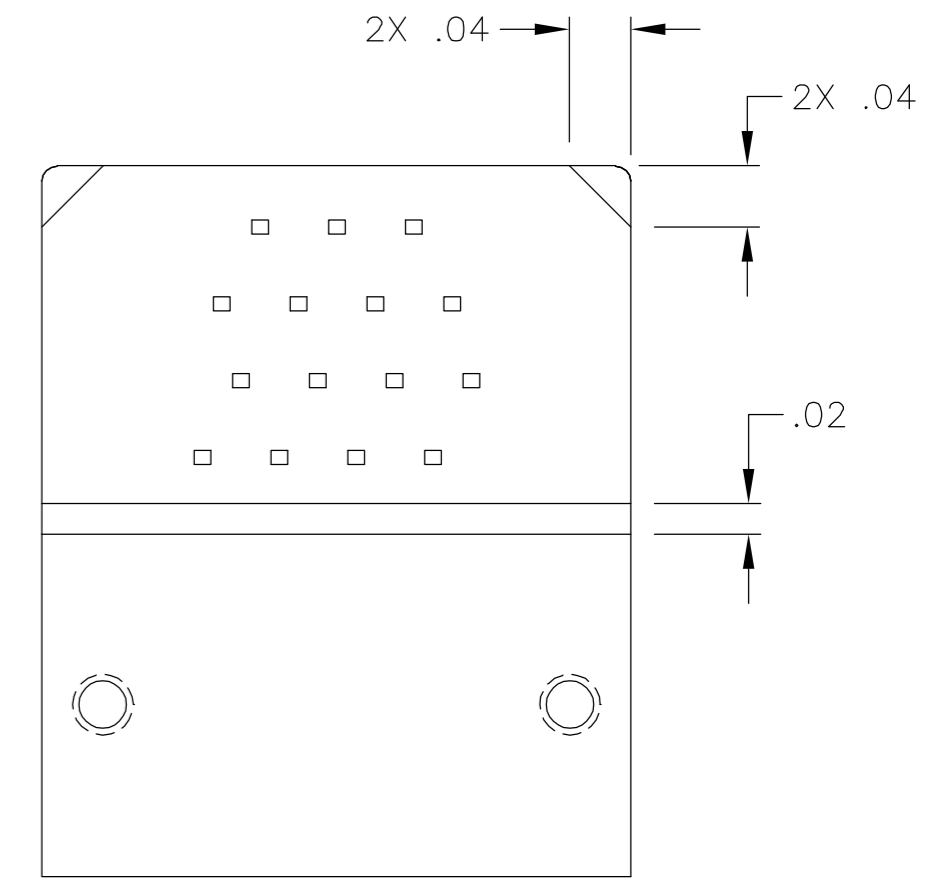
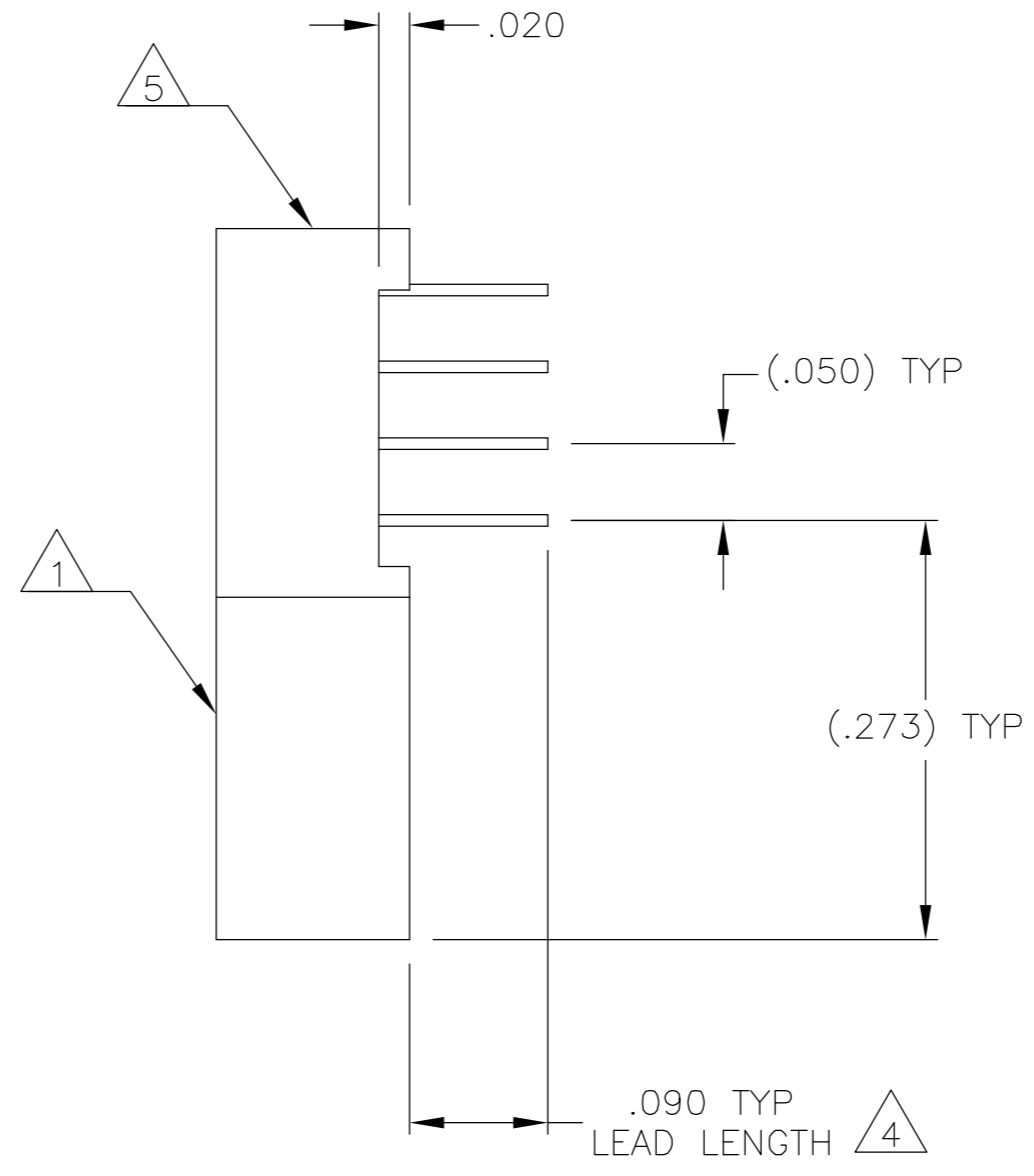
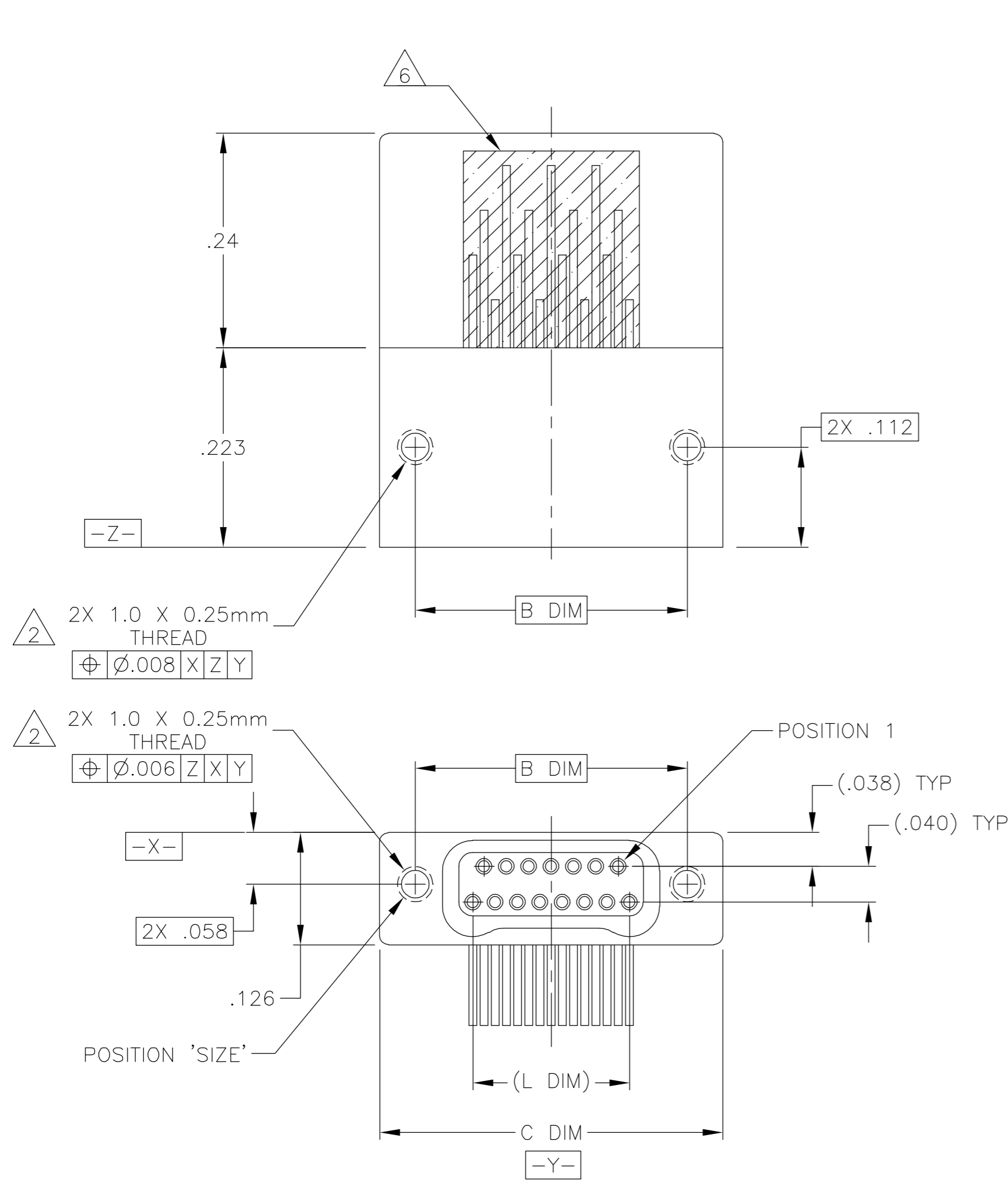

SIZE	B DIM	C DIM ±.0050	(L DIM)
09	.229	.3085	(.100)
15	.304	.3835	(.175)
25	.429	.5085	(.300)
37	.579	.6585	(.450)
51	.754	.8335	(.625)
65	.929	1.0085	(.800)

1. SHELL OPTIONS (TO BE SPECIFIED IN NANONICS PART NUMBER):  
 METAL: 6061-T6 ALUMINUM, ELECTROLESS NICKEL PLATED PER SAE-AMS-C-26074 (STANDARD) OR GOLD PLATED PER ASTM B488  
 303 STAINLESS STEEL, PASSIVATED PER SAE-AMS-2700  
 INSULATOR MATERIAL FOR ALL METAL SHELLS IS LIQUID CRYSTAL POLYMER (LCP) PER MIL-M-24519 OR PER ASTM D5138  
 PLASTIC: LIQUID CRYSTAL POLYMER (LCP) PER MIL-M-24519 OR PER ASTM D5138
2. STANDARD 1.0 X 0.25mm MOUNTING AND JACKSCREW THREADS ARE SHOWN FOR REFERENCE ONLY AND MUST BE SPECIFIED IN THE NANONICS PART NUMBER WHEN REQUIRED. 1.2 X 0.25mm THREADS ALSO AVAILABLE.
3. MOUNTING HARDWARE IS AVAILABLE WITH THIS CONFIGURATION (NOT SHOWN). HARDWARE MUST BE SPECIFIED IN THE NANONICS PART NUMBER. CONSULT TYCO ELECTRONICS FOR DETAILS.
4. LEADS ARE HH BRASS, GOLD PLATED PER ASTM B488
5. LEAD ORGANIZER MATERIAL IS LIQUID CRYSTAL POLYMER PER ASTM D5138
6. THROUGH HOLE LEADS ARE EPOXY ENCAPSULATED WITHIN THE LEAD ORGANIZER
7. TERMINATION CODE: W6
8. THIS DRAWING PREVIOUSLY IDENTIFIED AS NANONICS N10138/260

THIS DRAWING IS A CONTROLLED DOCUMENT.		DWN C. SCHOLL 5 AUG 03	Tyco Electronics Corporation Harrisburg, PA 17105	
DIMENSIONS: INCHES		CHK M. STORRY 5 AUG 03	NAME	
TOLERANCES UNLESS OTHERWISE SPECIFIED: 0 PLC ± - 1 PLC ± - 2 PLC ± .010 3 PLC ± .005 4 PLC ± - 1 ANGLES ± 1 FINISH SEE NOTES		APVD -	PRODUCT SPEC -	
MATERIAL SEE NOTES		APVD -	APPLICATION SPEC -	
SEE NOTES		WEIGHT -	SIZE A2	
SEE NOTES		CUSTOMER DRAWING		RESTRICTED TO -
SCALE 8:1		SHEET 1 of 2		REV C

1589809

A

THIS DRAWING IS UNPUBLISHED. RELEASED FOR PUBLICATION  
 © COPYRIGHT BY TYCO ELECTRONICS CORPORATION. ALL RIGHTS RESERVED.

LOC	DIST	REVISIONS			
P	LTR	DESCRIPTION	DATE	DWN	APVD
-	-	SEE SHEET 1	-	-	-

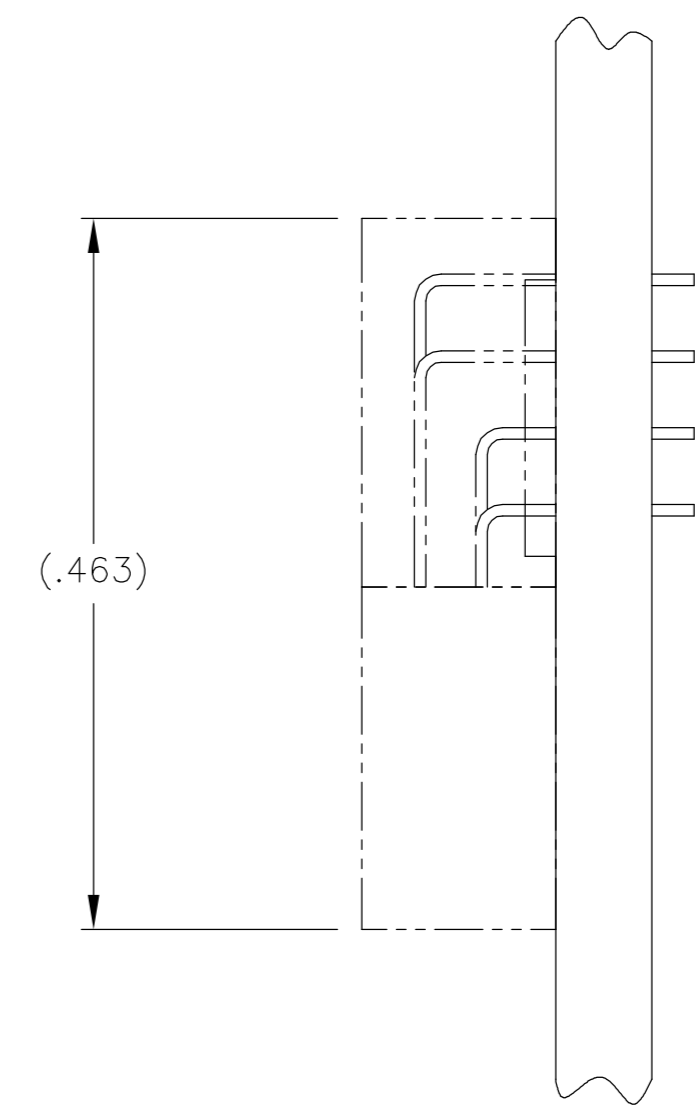
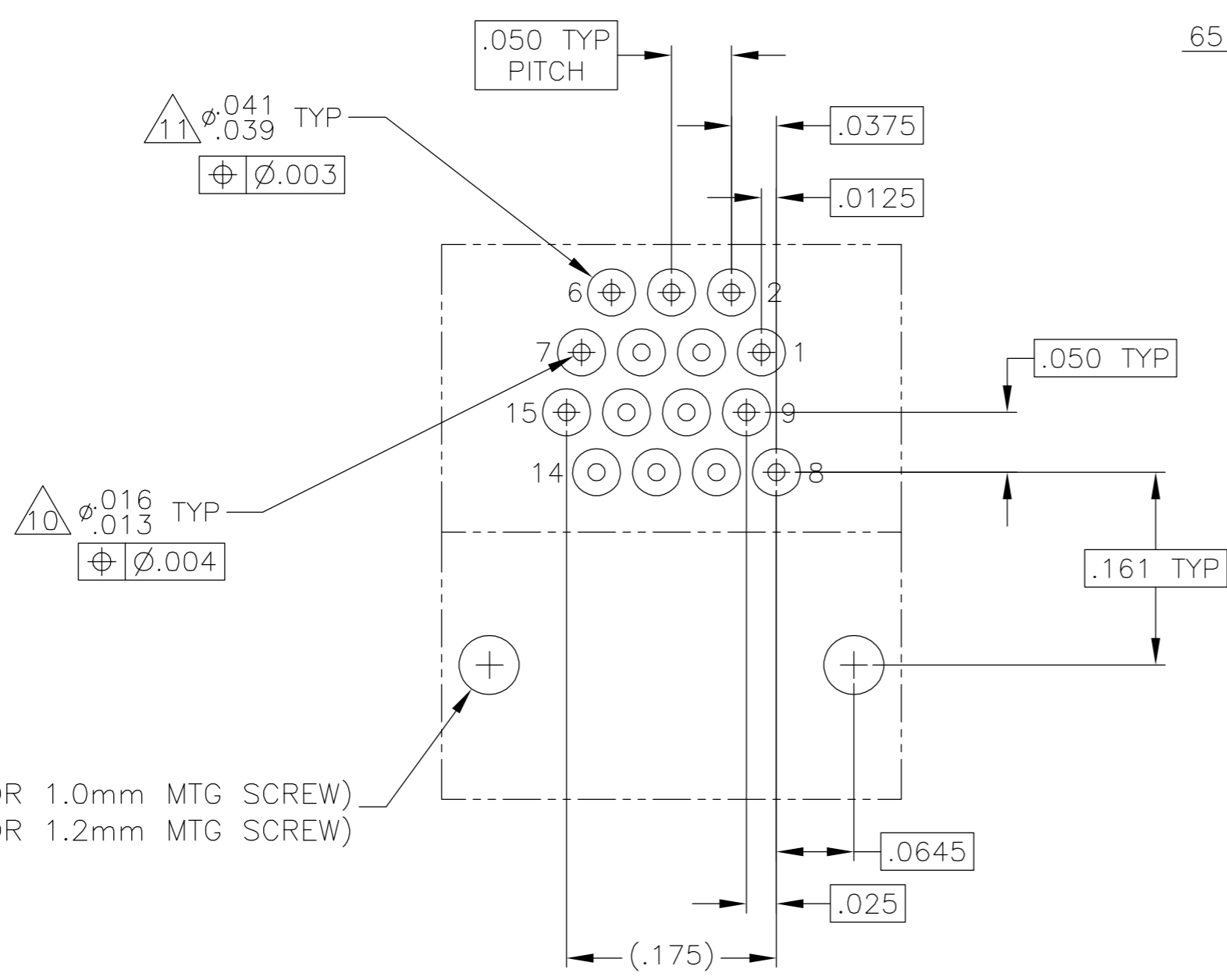
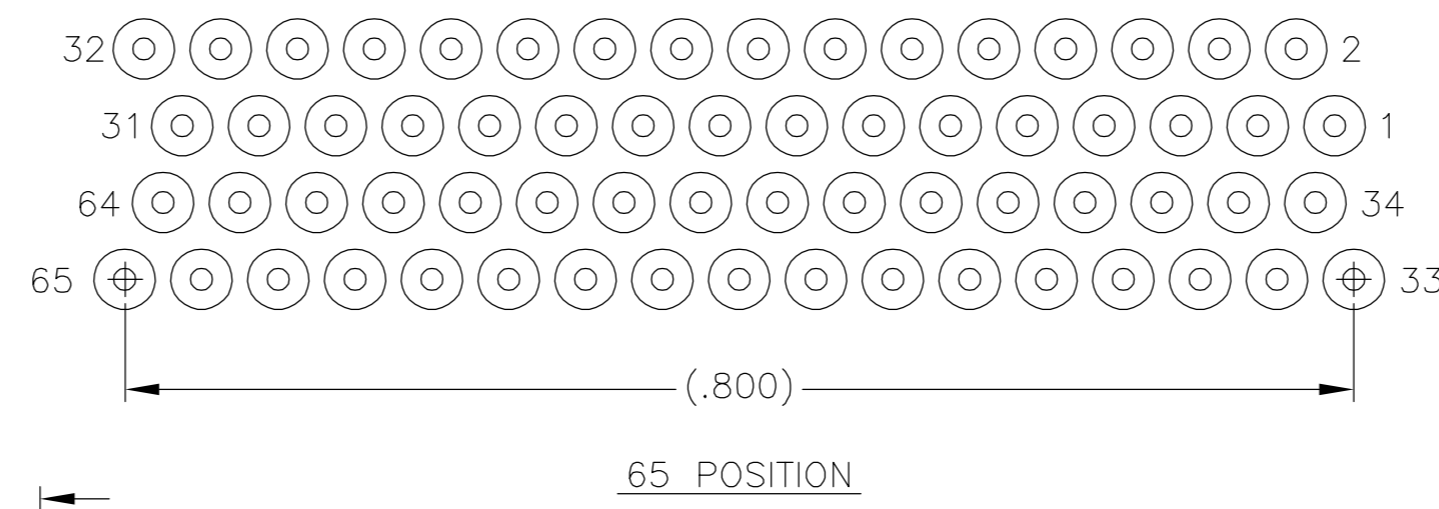
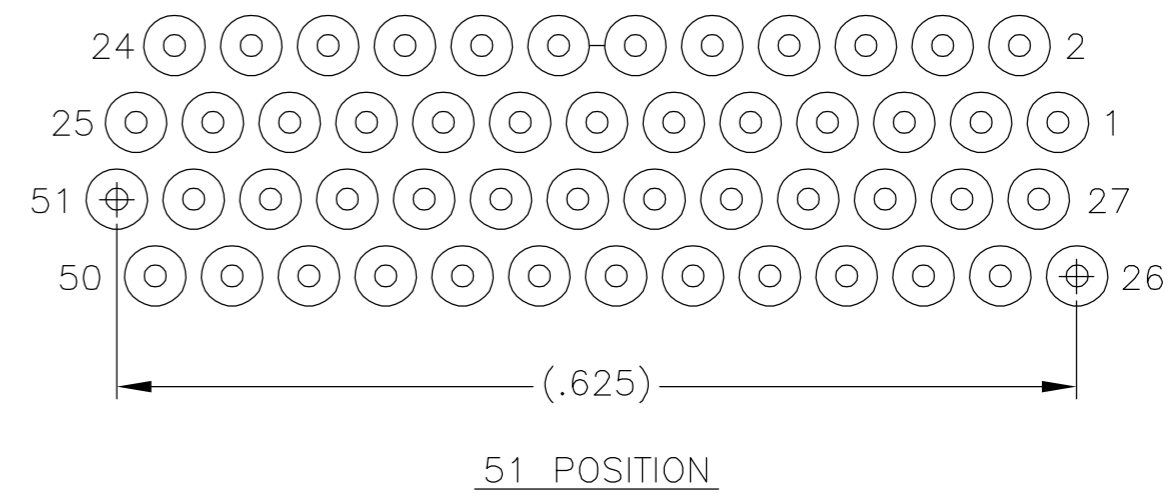
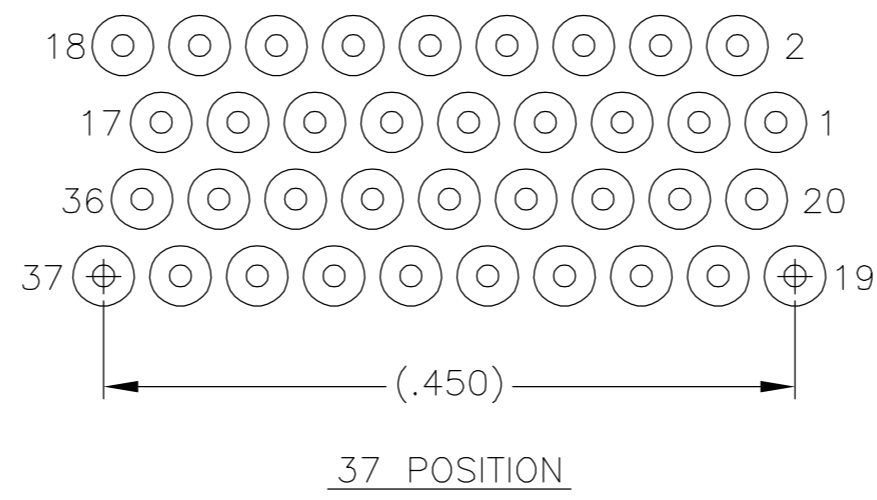
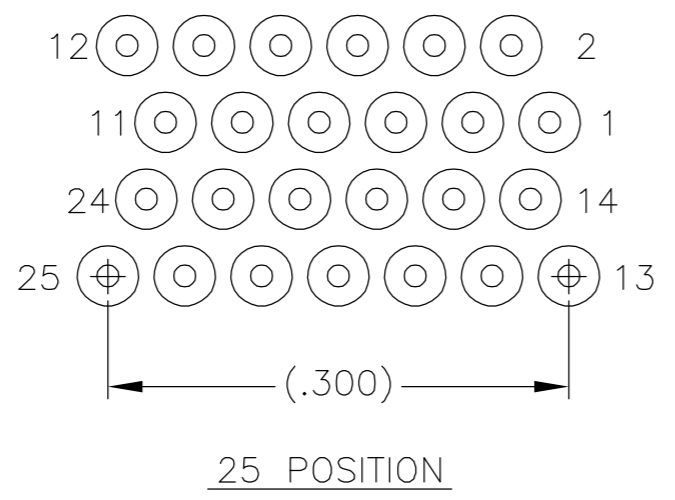
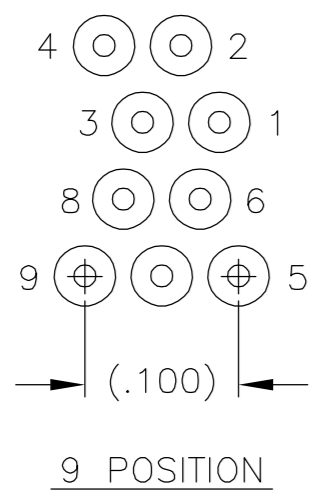

- 9. POSITIONAL TOLERANCES FOR BASIC DIMENSIONED FEATURES ARE RELATIVE TO FIDUCIALS OR SOME SIMILAR DATUM REFERENCES DEFINED BY PCB DESIGNER.
- 10. PLATED THROUGH HOLES
- 11. SOLDER PADS
- 12. ALL THROUGH HOLE LAYOUTS ARE AS VIEWED FROM TOP OF PCB.

THIS DRAWING IS A CONTROLLED DOCUMENT.		DWN C. SCHOLL 5 AUG 03	Tyco Electronics Corporation Harrisburg, PA 17105	
DIMENSIONS: INCHES	TOLERANCES UNLESS OTHERWISE SPECIFIED:	CHK M. STORRY 5 AUG 03	NAME	
	0 PLC ± -	APVD	PRODUCT SPEC	
	1 PLC ± -	-	APPLICATION SPEC	
	2 PLC ± .010	-	SIZE	RESTRICTED TO
	3 PLC ± .005	-	A2	-
MATERIAL	FINISH	4 PLC ± -	CAGE CODE	DRAWING NO
SEE NOTES	SEE NOTES	ANGLES ± 1	OPJN9	C=1589809
CUSTOMER DRAWING		WEIGHT	SCALE	SHEET
		-	8:1	2 of 2
		REVISIONS	REV	C

1589809

单击下面可查看定价，库存，交付和生命周期等信息

[>>TE Connectivity\(泰科\)](#)