

THIS DRAWING IS A CONTROLLED DOCUMENT. ALL RIGHTS RESERVED.  
 RELEASED FOR PUBLICATION  
 ALL RIGHTS RESERVED.

REVISIONS					
P	LTR	DESCRIPTION	DATE	DWN	APVD
A		ECR-21-123282	07DEC2021	F.F	M.S
B		ECR-22-131698	08MAR2022	F.F	M.S

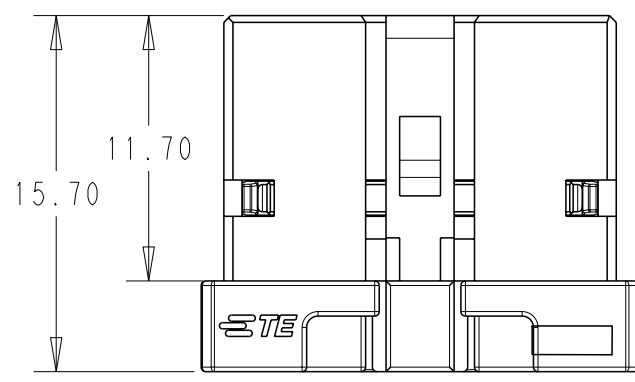

PIN DEFINITION AS SHOWN,  
 N MEANS MAX POSITIONS:  
 FOR EXAMPLE: N=12,PN IS 1-2834461-2

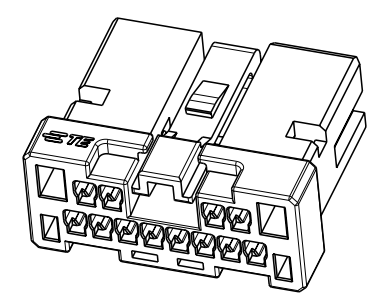
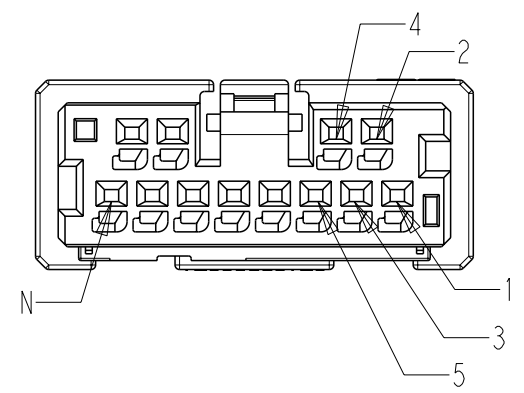

AS SHOWN: 1-2834461-2

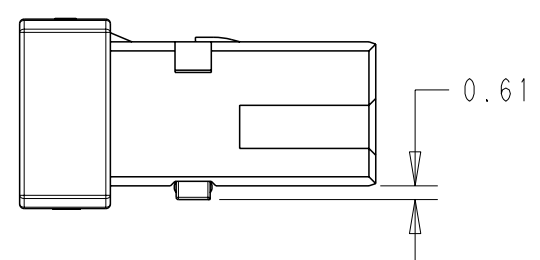
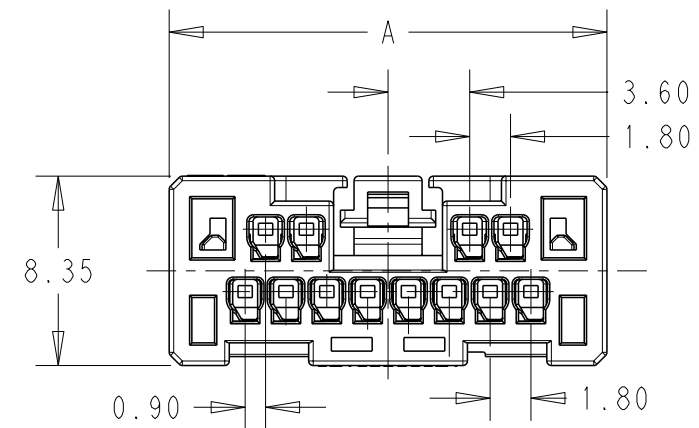

NOTES :

- MATERIAL: POLYBUTYLENE TEREPHTHALATE.
- PACKAGING: TRAY INSIDE OF CARTON.

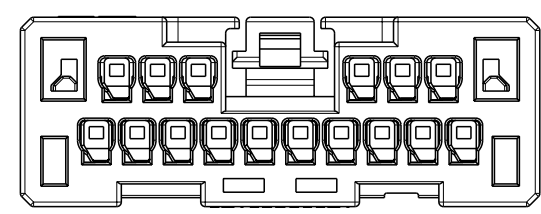

1-2834461-6

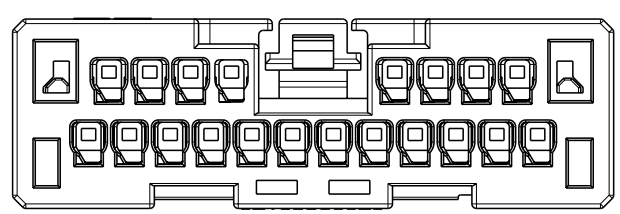

2-2834461-0

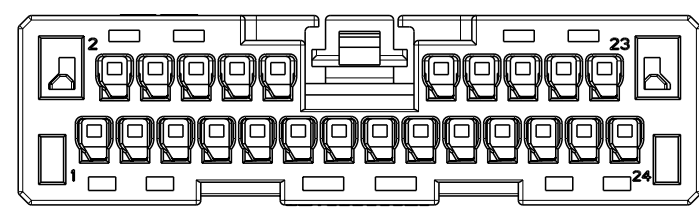

2-2834461-4

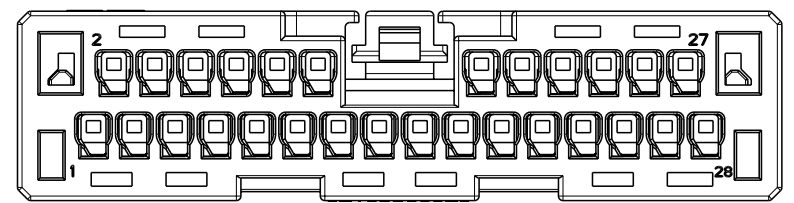

2-2834461-8

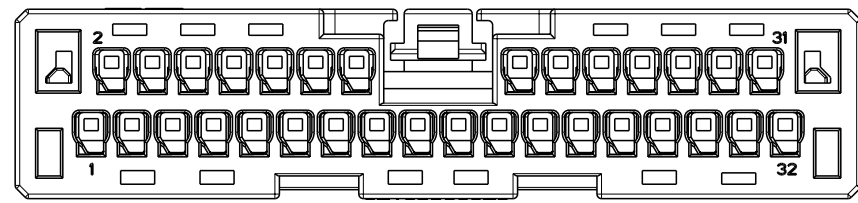

3-2834461-2

4-2834461-4	4-2834497-4	44	48.1
4-2834461-0	4-2834497-0	40	44.5
3-2834461-6	3-2834497-6	36	40.9
3-2834461-2	3-2834497-2	32	37.3
2-2834461-8	2-2834497-8	28	33.7
2-2834461-4	2-2834497-4	24	30.1
2-2834461-0	2-2834497-0	20	26.5
1-2834461-6	1-2834497-6	16	22.9
1-2834461-2	1-2834497-2	12	19.3
PN(X KEY)	PN(Y KEY)	POSITION	DIMENSION A

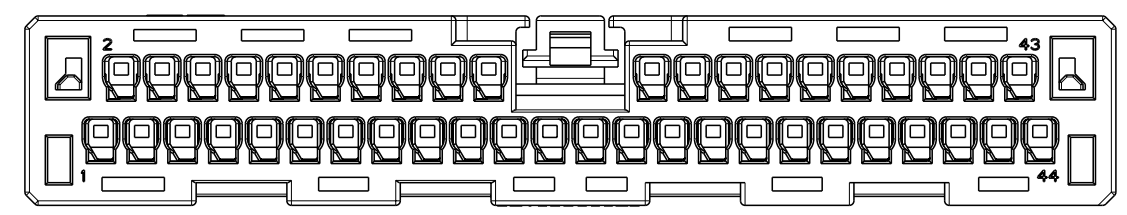

4-2834461-4

THIS DRAWING IS A CONTROLLED DOCUMENT.		DWN	12MAY2021	 TE Connectivity	NAME RECEPTACLE ASSEMBLY MINI DYNAMIC
DIMENSIONS: mm		FRANK FAN	12MAY2021		
TOLERANCES UNLESS OTHERWISE SPECIFIED:		CHK	GEORGE FU		
0 PLC ± 1 PLC ± 2 PLC ±0.25 3 PLC ± 4 PLC ± ANGLES ± FINISH -		APVD	MING SHI		
MATERIAL		PRODUCT SPEC		108-137443	RESTRICTED TO
TBD		APPLICATION SPEC		114-137527	
		WEIGHT		-	
		CUSTOMER DRAWING		SCALE	3:1
				SHEET	1 OF 2
				REV	B

printed on 8 Mar 2022 11:53 (China Standard Time) from TE310617

P	LTR	DESCRIPTION	DATE	DWN	APVD
		SEE SHEET1			

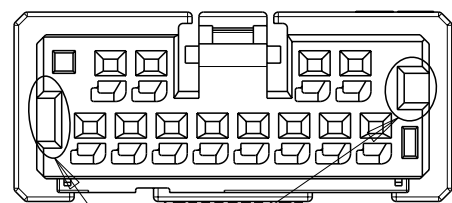

X KEY  
1-2834461-2

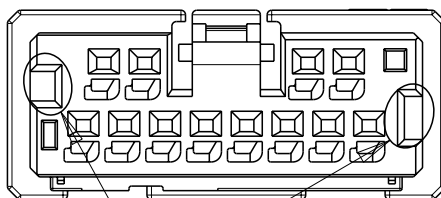

Y KEY  
1-2834497-2

NOTES:  
1. PLEASE REFER DIMENSIONS AND REQUIREMENTS IN SHEET1.

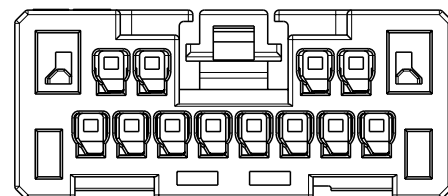

1-2834497-2

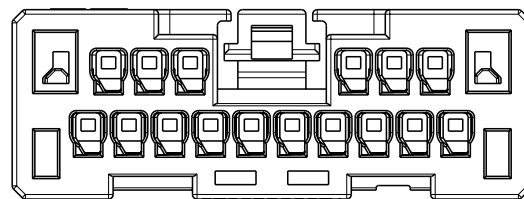

1-2834497-6

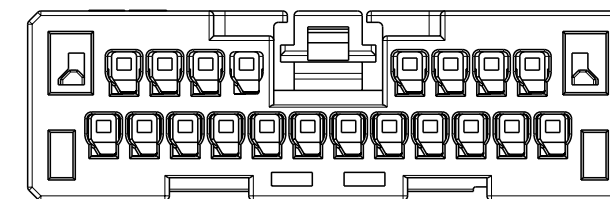

2-2834497-0

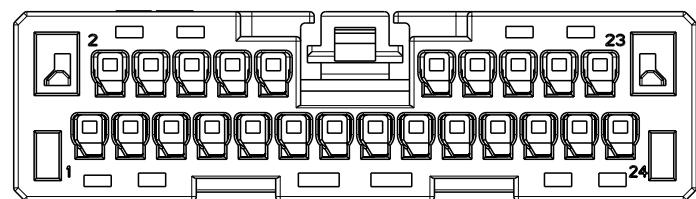

2-2834497-4

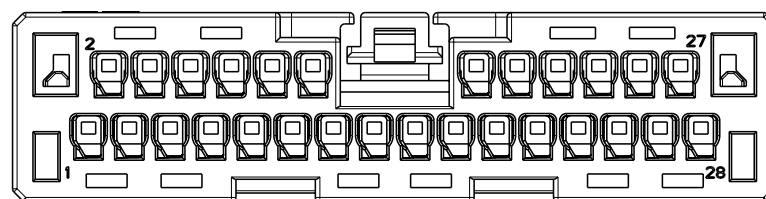

2-2834497-8

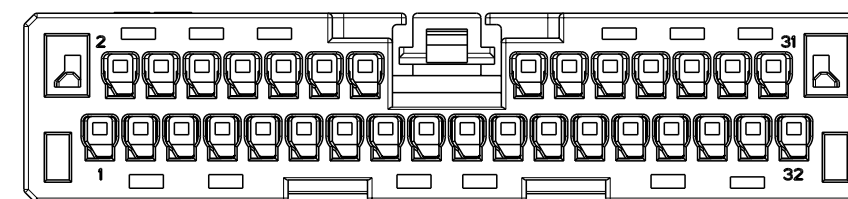

3-2834497-2

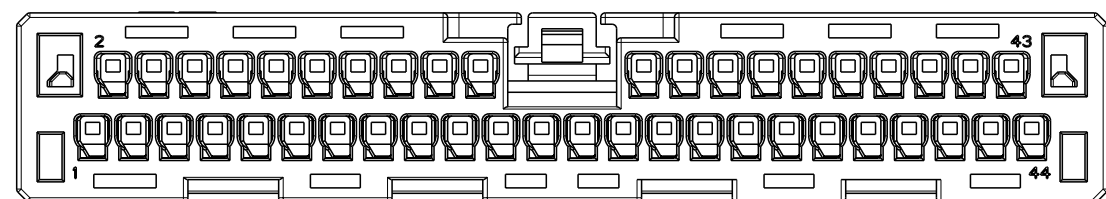

4-2834497-4

4-2834461-4	4-2834497-4	25	100	200
4-2834461-0	4-2834497-0	30	120	240
3-2834461-6	3-2834497-6	30	120	240
3-2834461-2	3-2834497-2	35	140	280
2-2834461-8	2-2834497-8	35	140	280
2-2834461-4	2-2834497-4	40	160	320
2-2834461-0	2-2834497-0	45	180	360
1-2834461-6	1-2834497-6	45	180	360
1-2834461-2	1-2834497-2	55	220	440
PN(X KEY)	PN(Y KEY)	QUANTITY PER TRAY / PCS	QUANTITY PER MIDDLE BOX / PCS	QUANTITY PER OUTER BOX / PCS

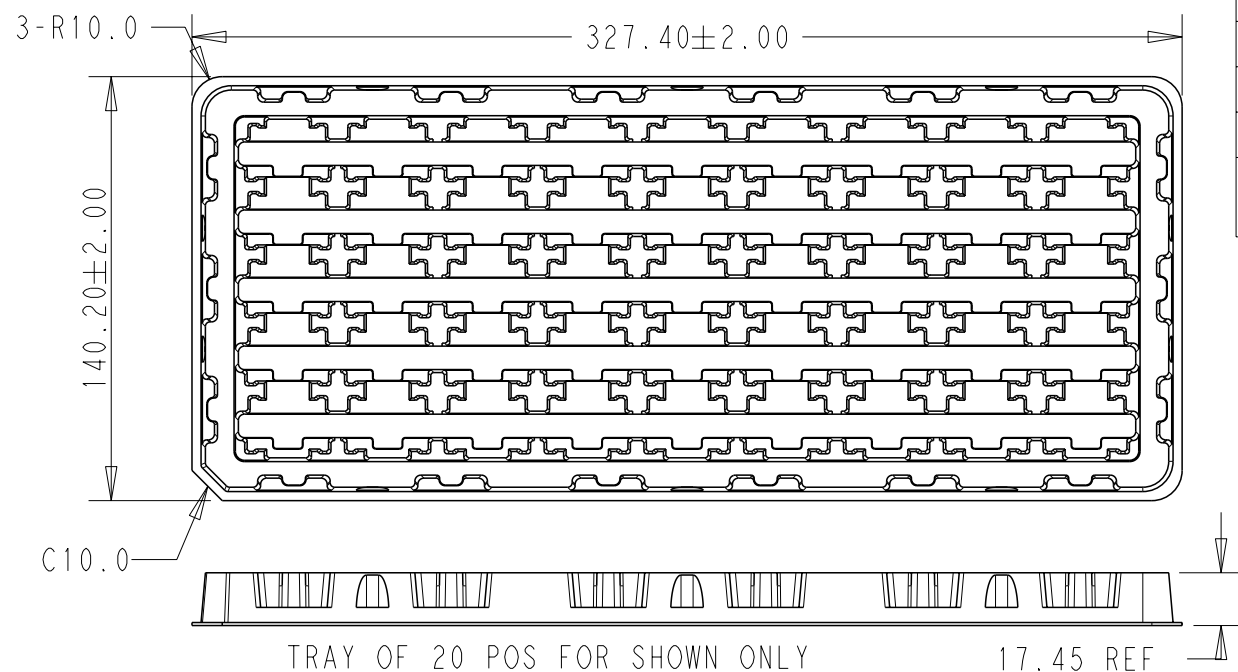

THIS DRAWING IS A CONTROLLED DOCUMENT.

DIMENSIONS:  
mm

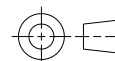

MATERIAL  
TBD

TOLERANCES UNLESS OTHERWISE SPECIFIED:

0 PLC	±-
1 PLC	±
2 PLC	±0.25
3 PLC	±
4 PLC	±
ANGLES	±
FINISH	-

DWN 12MAY2021  
FRANK FAN  
CHK 12MAY2021  
GEORGE FU  
APVD 12MAY2021  
MING SHI  
PRODUCT SPEC  
108-137443  
APPLICATION SPEC  
114-137527  
WEIGHT -



NAME  
RECEPTACLE ASSEMBLY  
MINI DYNAMIC

SIZE A3	CAGE CODE 00779	DRAWING NO C-2834461	RESTRICTED TO -
------------	--------------------	-------------------------	--------------------

CUSTOMER DRAWING SCALE 3:1 SHEET 2 OF 2 REV B

Printed on 8 Mar 2022 11:53 (China Standard Time) from TE310617

单击下面可查看定价，库存，交付和生命周期等信息

[>>TE Connectivity\(泰科\)](#)