

THIS DRAWING IS UNPUBLISHED. RELEASED FOR PUBLICATION
 © COPYRIGHT - By - ALL RIGHTS RESERVED.

| LOC | DIST | REVISIONS | | | | | |
|-----|------|-----------|-----|---------------------------|---------|-----|------|
| FT | 0 | P | LTR | DESCRIPTION | DATE | DWN | APVD |
| | | | K18 | REVISED PER ECO-11-004587 | 11MAR11 | RK | HMR |

PHYSICAL PROPERTIES:
 HOUSING MATERIAL: THERMOPLASTIC, PC
 FLAMABILITY: UL94V-0
 COLOR: BLACK

TERMINAL:
 TERMINALS: BRASS, TIN PLATED
 SCREWS: 6-32 STEEL, NICKEL PLATED

MECHANICAL:
 PITCH: .437
 WIRE RANGE: 14-22 AWG
 RECOMMENDED TIGHTENING TORQUE: 12IN-LB

ELECTRICAL PROPERTIES:
 MAX CURRENT: 25A
 OPERATING VOLTAGE: 300V

ENVIRONMENTAL PROPERTIES:
 OPERATING TEMP: -40°C TO 120°C

- 1 SEE FIGURE.
- 2 PRELIMINARY PART NUMBER.
- 3 STAINLESS STEEL SCREWS.
- 4 WHITE INK STAMP.
- 5 TE CONNECTIVITY LOGO LOCATED APPROXIMATE AREA.

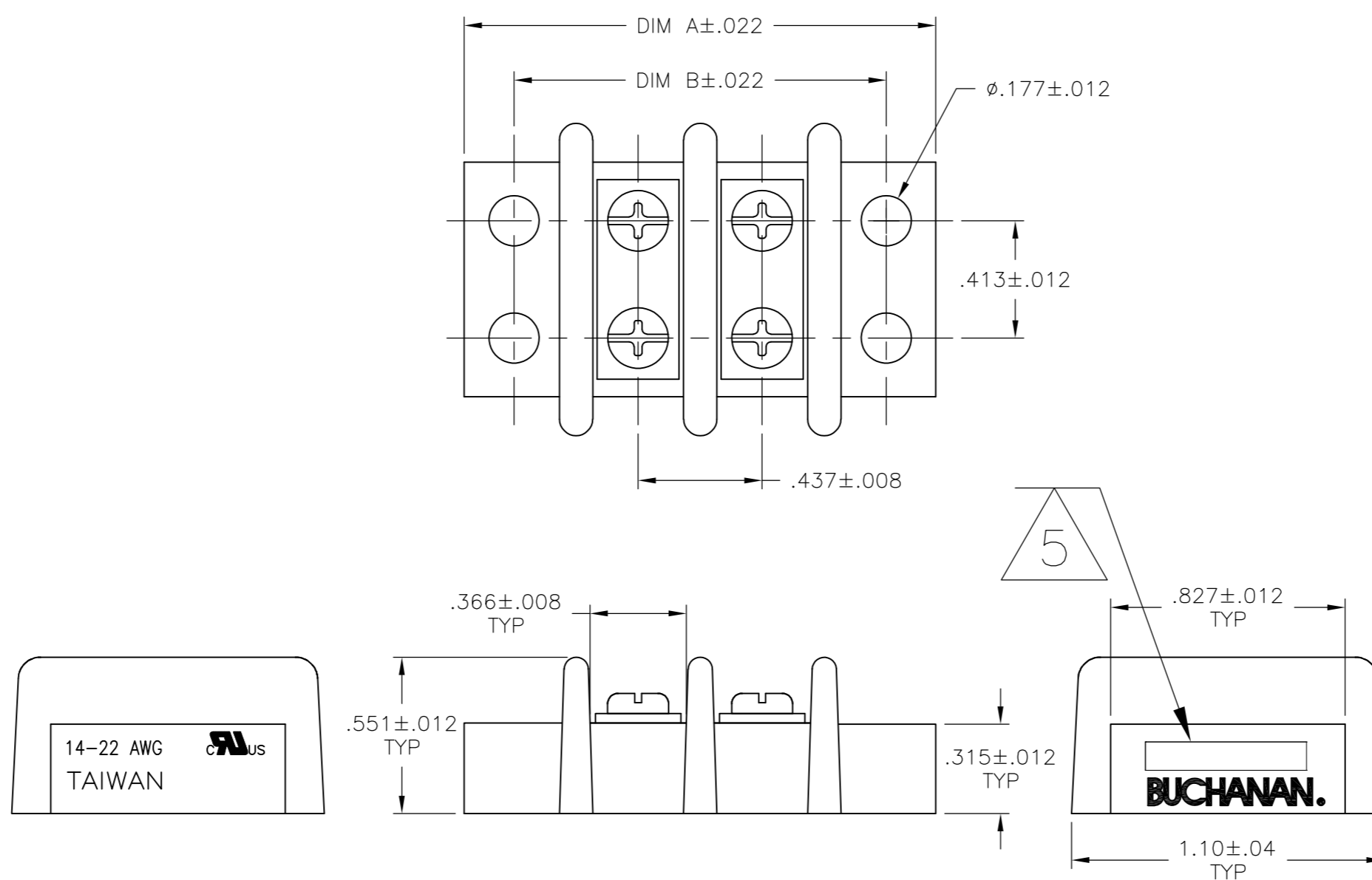

| | | | |
|-------|-------|-----------|-------------|
| 5.646 | 5.992 | 12 | 4-1546670-2 |
| 9.142 | 9.488 | 20 | 2-1546670-0 |
| 8.705 | 9.051 | 19 | 1-1546670-9 |
| 8.268 | 8.614 | 18 | 3-1546670-0 |
| 8.268 | 8.614 | 18 | 1-1546670-8 |
| 7.831 | 8.177 | 17 | 1-1546670-7 |
| 7.394 | 7.740 | 16 | 1-1546670-6 |
| 6.957 | 7.303 | 15 | 1-1546670-5 |
| 6.520 | 6.866 | 14 | 1-1546670-4 |
| 6.083 | 6.429 | 13 | 1-1546670-3 |
| 5.646 | 5.992 | 12 | 1-1546670-2 |
| 5.209 | 5.555 | 11 | 1-1546670-1 |
| 4.772 | 5.118 | 10 | 4-1546670-3 |
| 4.772 | 5.118 | 10 | 3-1546670-8 |
| 4.772 | 5.118 | 10 | 1-1546670-0 |
| 4.335 | 4.681 | 9 | 3-1546670-5 |
| 4.335 | 4.681 | 9 | 3-1546670-2 |
| 4.335 | 4.681 | 9 | 1546670-9 |
| 3.898 | 4.244 | 8 | 4-1546670-1 |
| 3.898 | 4.244 | 8 | 3-1546670-6 |
| 3.898 | 4.244 | 8 | 3-1546670-4 |
| 3.898 | 4.244 | 8 | 3-1546670-3 |
| 3.898 | 4.244 | 8 | 1546670-8 |
| 3.461 | 3.807 | 7 | 1546670-7 |
| 3.024 | 3.370 | 6 | 3-1546670-1 |
| 3.024 | 3.370 | 6 | 1546670-6 |
| 2.587 | 2.933 | 5 | 2-1546670-8 |
| 2.587 | 2.933 | 5 | 2-1546670-7 |
| 2.587 | 2.933 | 5 | 1546670-5 |
| 2.496 | 2.933 | 4 | 3-1546670-9 |
| 2.150 | 2.496 | 4 | 2-1546670-9 |
| 2.150 | 2.496 | 4 | 1546670-4 |
| 1.713 | 2.059 | 3 | 1546670-3 |
| 1.276 | 1.622 | 2 | 1546670-2 |
| DIM B | DIM A | NO OF POS | PART NUMBER |

THIS DRAWING IS A CONTROLLED DOCUMENT.

| | | |
|------|-----------|--------|
| DWN | S SCHEGEL | 4/4/03 |
| CHK | C RICHARD | 4/4/03 |
| APVD | C RICHARD | 4/4/03 |

TE Connectivity

DOUBLE ROW BARRIER STRIP W/ BINDING HD SCREW, .437 SPACING

| | | | | | | | |
|--------|----|-----------|-------|------------|-----------|---------------|-----|
| SIZE | A2 | CAGE CODE | 00779 | DRAWING NO | C=1546670 | RESTRICTED TO | - |
| WEIGHT | - | SCALE | NTS | SHEET | 1 of 3 | REV | K18 |

CUSTOMER DRAWING

THIS DRAWING IS UNPUBLISHED. RELEASED FOR PUBLICATION
 © COPYRIGHT - By - ALL RIGHTS RESERVED.

| LOC | | DIST | | REVISIONS | | | | |
|-----|-----|-------------|--|-----------|-----|------|--|--|
| P | LTR | DESCRIPTION | | DATE | DWN | APVD | | |
| FT | 0 | SEE SHEET 1 | | - | - | - | | |

DOUBLE SIDED, DOUBLE HOLE
QC TAB, QTY 5

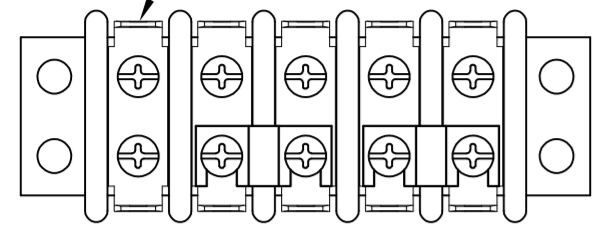

DOUBLE SIDED, DOUBLE HOLE
QC TAB, QTY 5

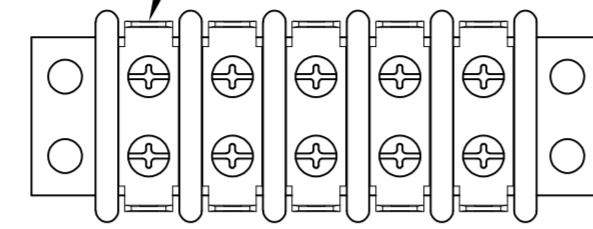

JUMPER, QTY 1

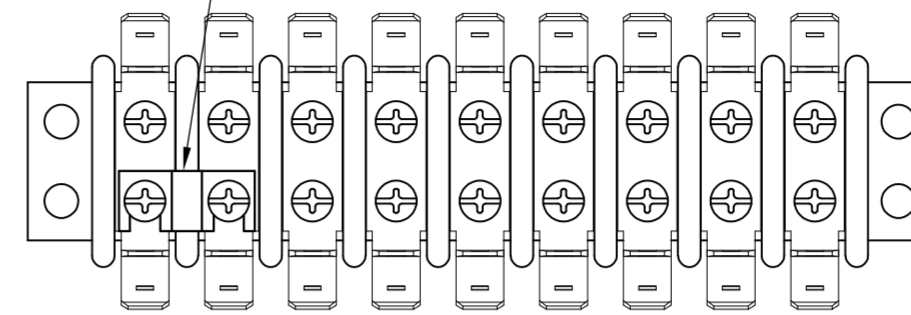

DOUBLE SIDED, DOUBLE HOLE
45° QC TAB, QTY 9

DOUBLE SIDED, DOUBLE HOLE
90° QC TAB, QTY 9

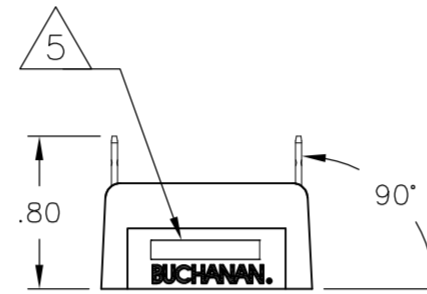
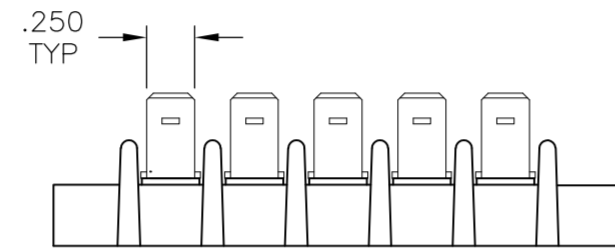
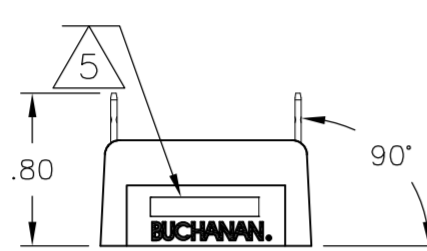
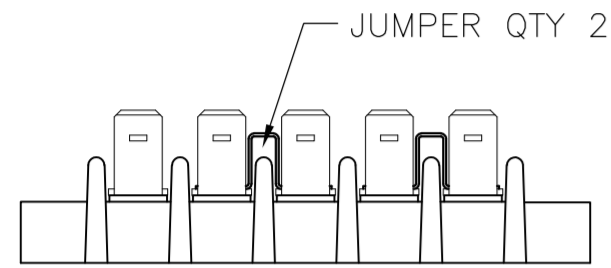
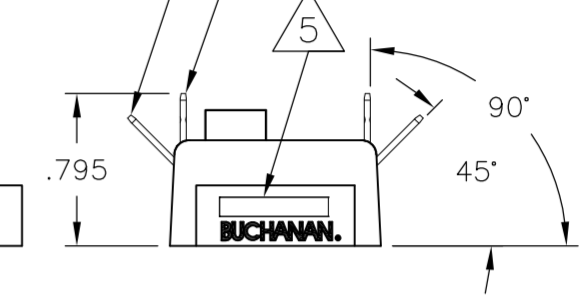

2-1546670-7

2-1546670-8

3-1546670-2

DOUBLE SIDED, DOUBLE HOLE
QC TAB, QTY 5

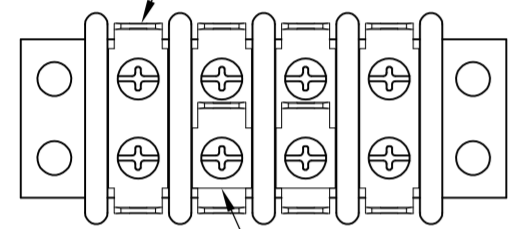

SINGLE SIDED, DOUBLE HOLE
QC TAB, QTY 6

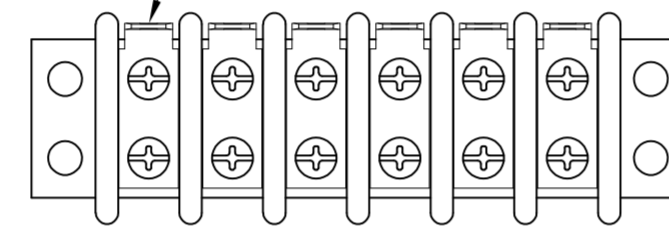

DOUBLE SIDED, DOUBLE HOLE
FLAT QC TAB, QTY 8.

JUMPER, QTY 2

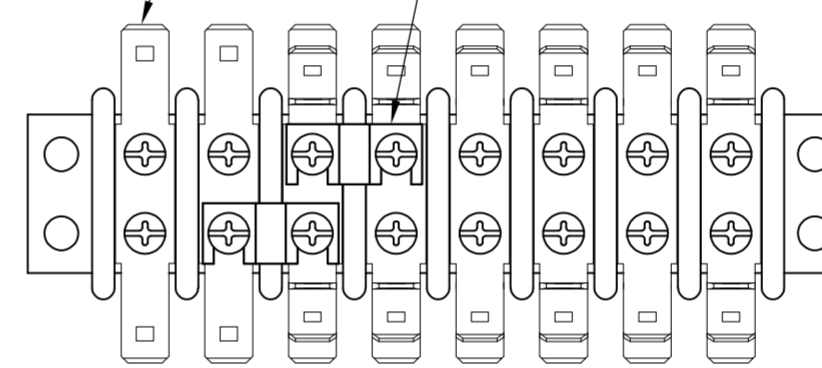

DOUBLE SIDED, DOUBLE HOLE
45° QC TAB, QTY 6

DOUBLE SIDED, DOUBLE HOLE
90° QC TAB, QTY 4

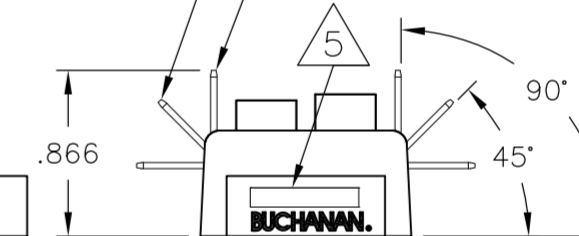

SINGLE SIDED, SINGLE HOLE
QC TAB, QTY 2

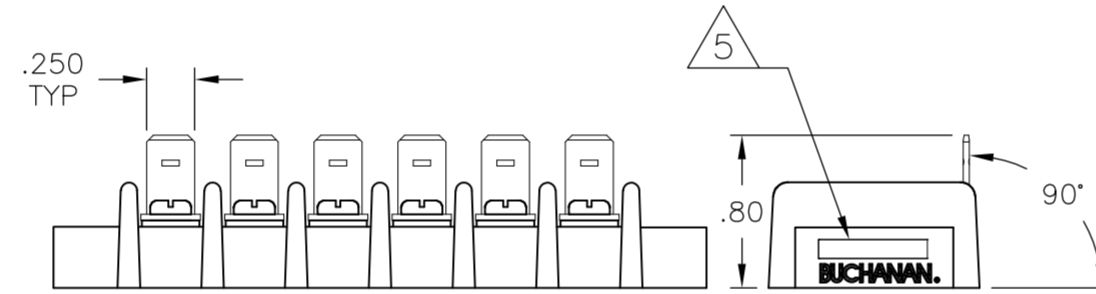
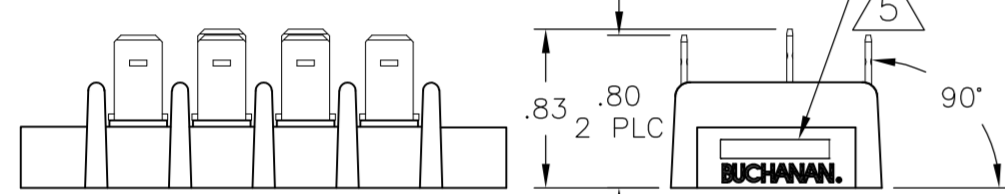

2-1546670-9

3-1546670-1

3-1546670-3

SINGLE SIDED, DOUBLE HOLE
QC TAB, QTY 18

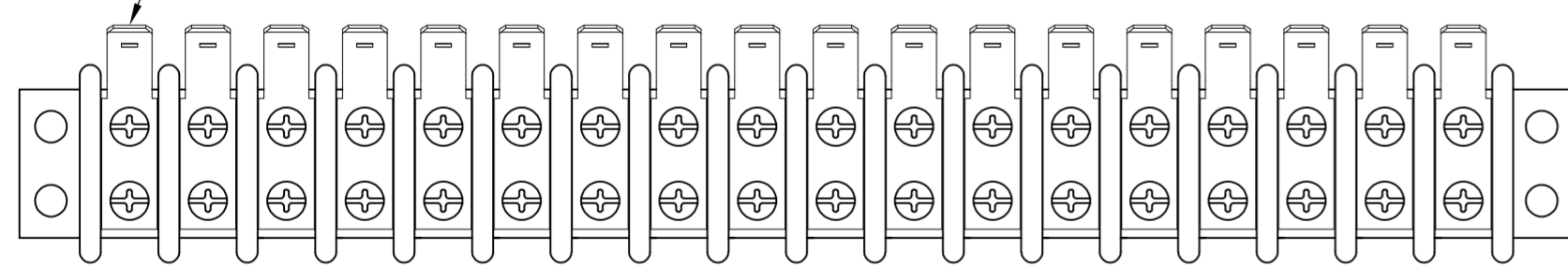

DOUBLE SIDED, DOUBLE HOLE
FLAT QC TAB, QTY 8.

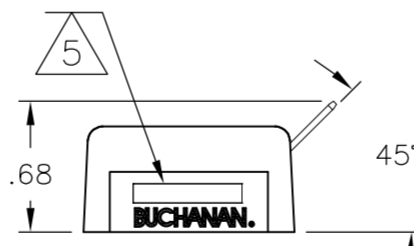
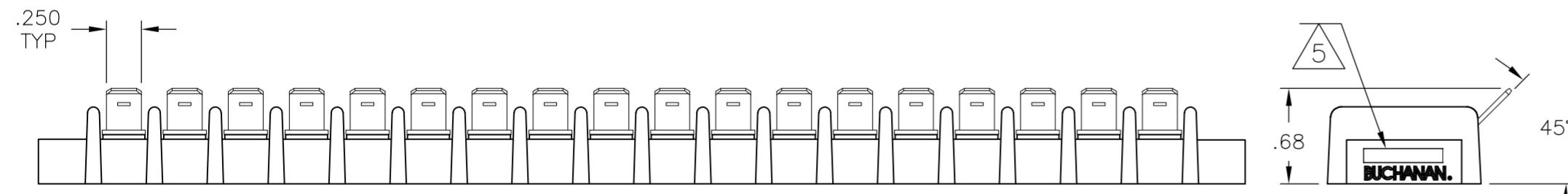
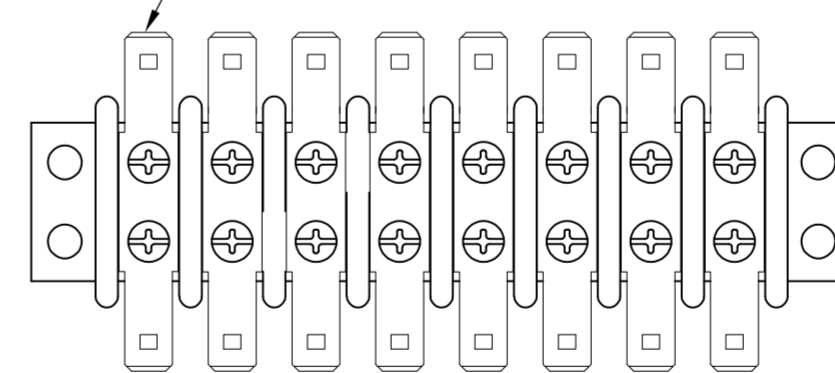

3-1546670-0

3-1546670-4

| | | | |
|--------|--------|-----------|-------------|
| 11.764 | 12.110 | 26 | 2-1546670-6 |
| 11.327 | 11.673 | 25 | 2-1546670-5 |
| 10.90 | 11.236 | 24 | 2-1546670-4 |
| 10.453 | 10.799 | 23 | 2-1546670-3 |
| 10.016 | 10.362 | 22 | 2-1546670-2 |
| 9.579 | 9.925 | 21 | 2-1546670-1 |
| 9.142 | 9.488 | 20 | 3-1546670-7 |
| DIM B | DIM A | NO OF POS | PART NUMBER |

| DIMENSIONS: | | TOLERANCES UNLESS OTHERWISE SPECIFIED: | | DWN | | S | |
|--|--|--|--------|------------------|---------|-----------|--------|
| INCHES | | 0 PLC | ± - | 4/4/03 | SCHEGEL | | 4/4/03 |
| | | 1 PLC | ± - | 4/4/03 | RICHARD | | 4/4/03 |
| | | 2 PLC | ± .01 | APVD | | RICHARD | |
| | | 3 PLC | ± .005 | PRODUCT SPEC | | 4/4/03 | |
| | | 4 PLC | ± - | APPLICATION SPEC | | - | |
| | | ANGLES | ± 3' | WEIGHT | | - | |
| MATERIAL | | FINISH | | - | | - | |
| THIS DRAWING IS A CONTROLLED DOCUMENT. | | | | CUSTOMER DRAWING | | SCALE NTS | |
| NAME | | | | SIZE | | CAGE CODE | |
| DOUBLE ROW BARRIER STRIP W/ BINDING HD | | | | A2 | | 00779 | |
| SCREW, .437 SPACING | | | | DRAWING NO | | C=1546670 | |
| RESTRICTED TO | | | | SHEET | | 2 OF 3 | |
| REV | | | | K18 | | REV | |

THIS DRAWING IS UNPUBLISHED. RELEASED FOR PUBLICATION
 © COPYRIGHT - By - ALL RIGHTS RESERVED.

| LOC | | DIST | | REVISIONS | | | |
|-----|-----|-------------|------|-----------|------|--|--|
| P | LTR | DESCRIPTION | DATE | DWN | APVD | | |
| FT | 0 | SEE SHEET 1 | - | - | - | | |



3-1546670-5



4-1546670-3

SINGLE SIDED, DOUBLE HOLE
45° QC TAB, QTY 10

SINGLE SIDED, DOUBLE HOLE
90° QC TAB, QTY 10



SINGLE SIDED, DOUBLE HOLE
FLAT QC TAB, QTY 10



3-1546670-7

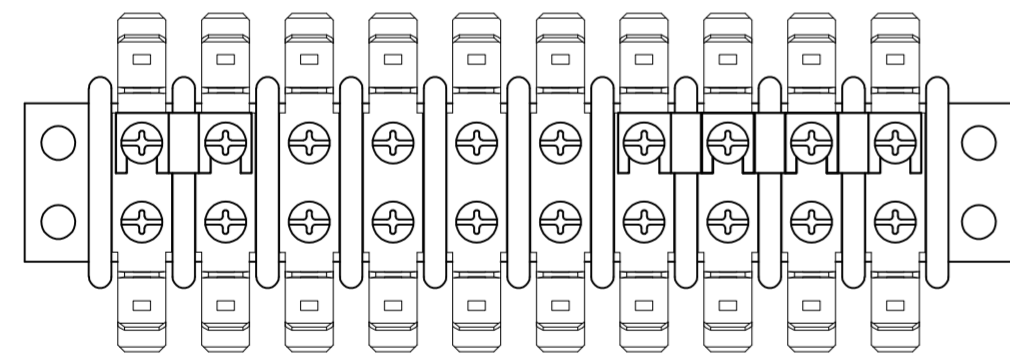
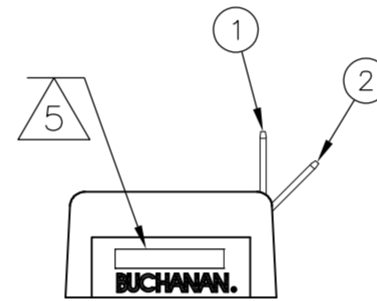

3-1546670-8

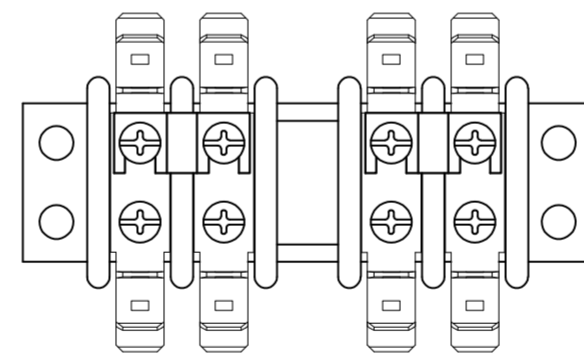
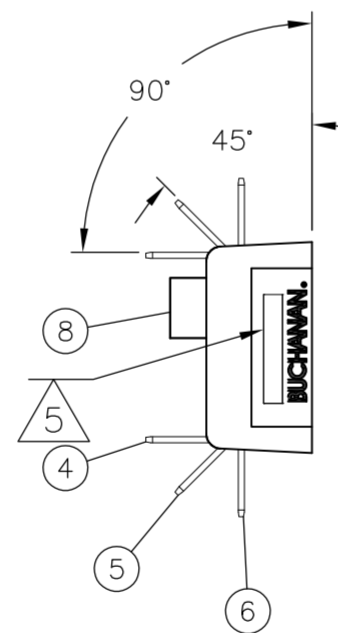

3-1546670-9

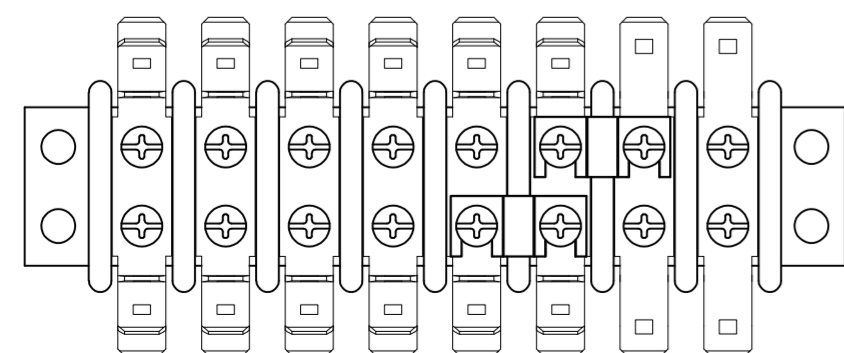
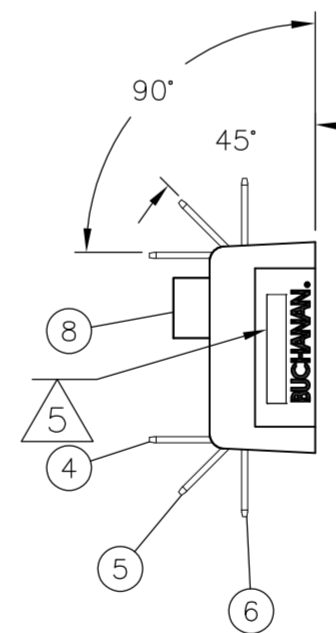

4-1546670-1

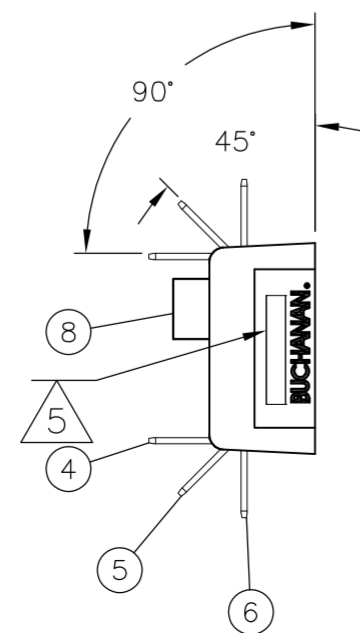

| | | | | |
|--|--------------|-----------------------|--|---------------|
| THIS DRAWING IS A CONTROLLED DOCUMENT. | | DWN S SCHEGEL 4/4/03 | TE Connectivity | |
| DIMENSIONS: INCHES | | CHK C RICHARD 4/4/03 | | |
| TOLERANCES UNLESS OTHERWISE SPECIFIED: | | APVD C RICHARD 4/4/03 | NAME | |
| 0 PLC ± - | 1 PLC ± - | PRODUCT SPEC | DOUBLE ROW BARRIER STRIP W/ BINDING HD SCREW, .437 SPACING | |
| 2 PLC ± .01 | 3 PLC ± .005 | APPLICATION SPEC | SIZE | CAGE CODE |
| 4 PLC ± - | ANGLES ± 3' | WEIGHT - | A2 | 00779 |
| MATERIAL - | FINISH - | CUSTOMER DRAWING | DRAWING NO | RESTRICTED TO |
| | | | C=1546670 | - |
| | | | SCALE NTS | SHEET 3 of 3 |
| | | | REV | K18 |

单击下面可查看定价，库存，交付和生命周期等信息

[>>TE Connectivity\(泰科\)](#)