

REVISIONS				
P	LTR	DESCRIPTION	DATE	APVD
A		RELEASE TO PRODUCTION	09DEC2019	AY PS
A1		REMOVE POSITION 4, 6 AND 8	04JUN2020	AY PS

- NOTES:
- MATERIAL
HOUSING & P&P CAP : HIGH TEMPERATURE THERMOPLASTIC, UL94-V0; COLOR- BLACK
POST : COPPER ALLOY
FINISH :
MATING SIDE: MIN. 0.1 μm GOLD OVER NICKEL UNDER PLATING.
SOLDER SIDE: MIN. 2.0 μm TIN OVER NICKEL UNDER PLATING.
 - PACKAGING: TUBE (WITH PICK AND PLACE CAP)
- △ TOLERANCE NOT CUMULATIVE.

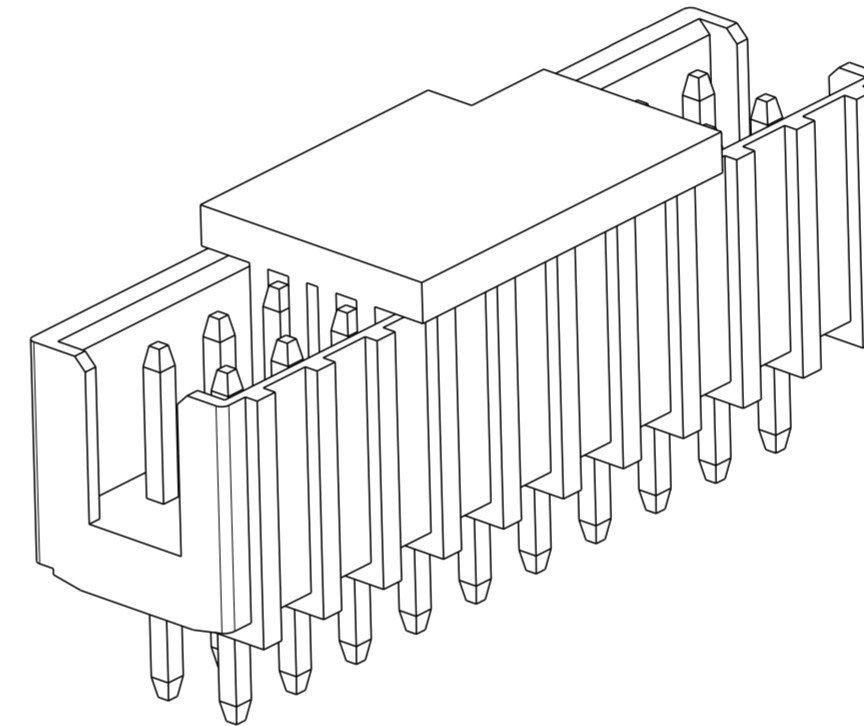

52.10	51.40	50	5-2842286-0
50.10	49.40	48	4-2842286-8
48.10	47.40	46	4-2842286-6
46.10	45.40	44	4-2842286-4
44.10	43.40	42	4-2842286-2
42.10	41.40	40	4-2842286-0
40.10	39.40	38	3-2842286-8
38.10	37.40	36	3-2842286-6
36.10	35.40	34	3-2842286-4
34.10	33.40	32	3-2842286-2
32.10	31.40	30	3-2842286-0
30.10	29.40	28	2-2842286-8
28.10	27.40	26	2-2842286-6
26.10	25.40	24	2-2842286-4
24.10	23.40	22	2-2842286-2
22.10	21.40	20	2-2842286-0
20.10	19.40	18	1-2842286-8
18.10	17.40	16	1-2842286-6
16.10	15.40	14	1-2842286-4
14.10	13.40	12	1-2842286-2
12.10	11.40	10	1-2842286-0
DIM "F"	DIM "E"	POS.	TE PN.

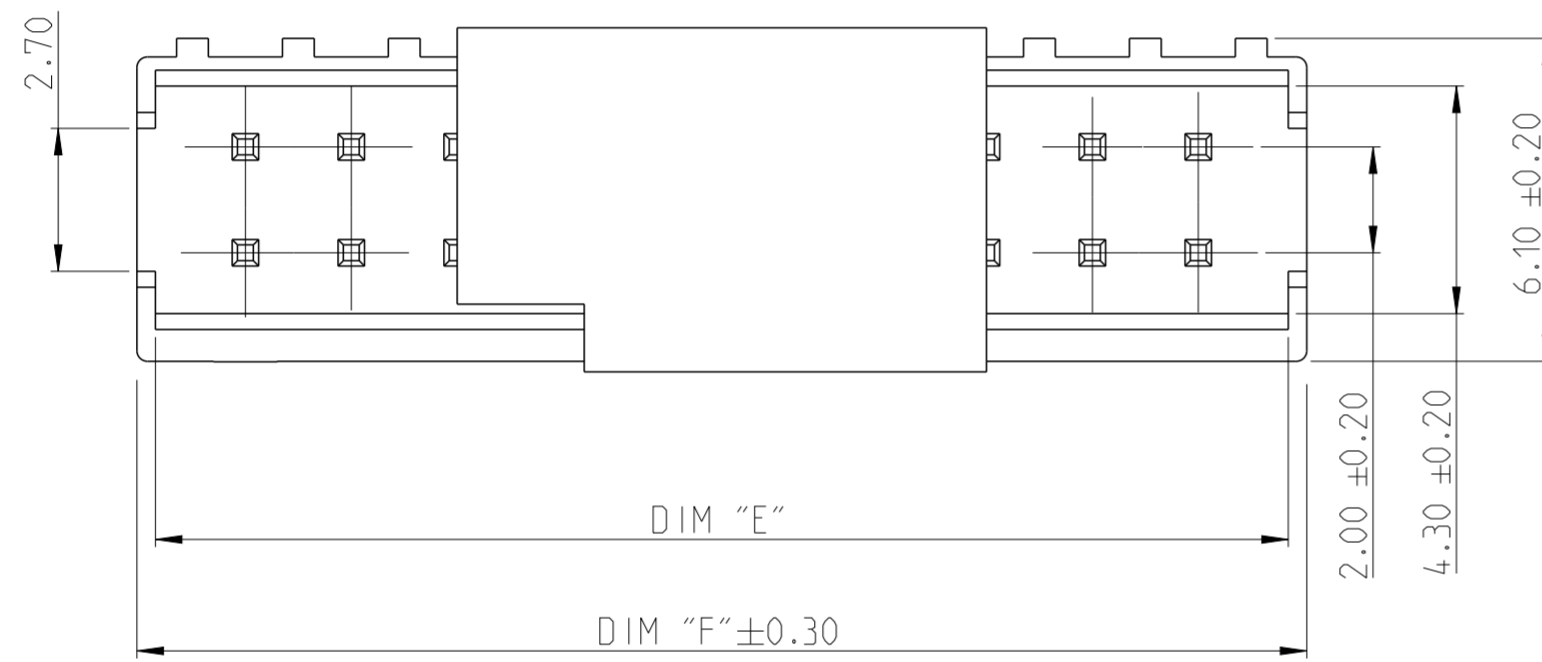
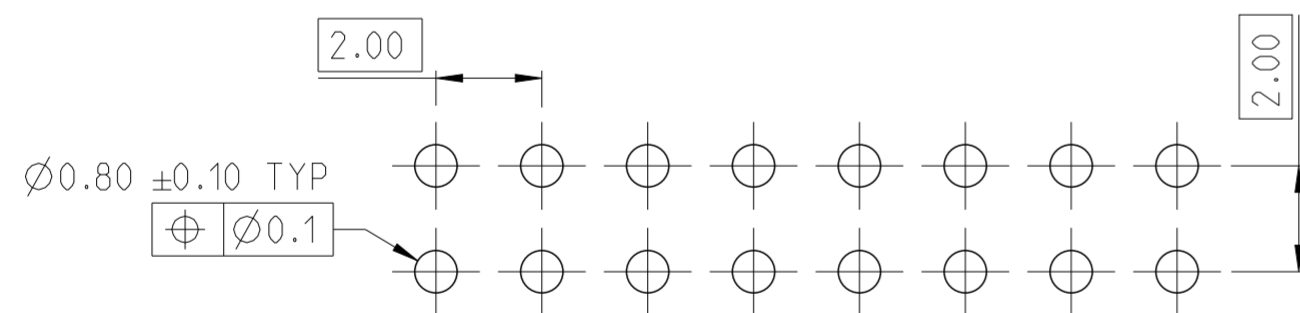

RECOMMENDED PCB HOLE PATTERN FOR THROUGH HOLE WAVE

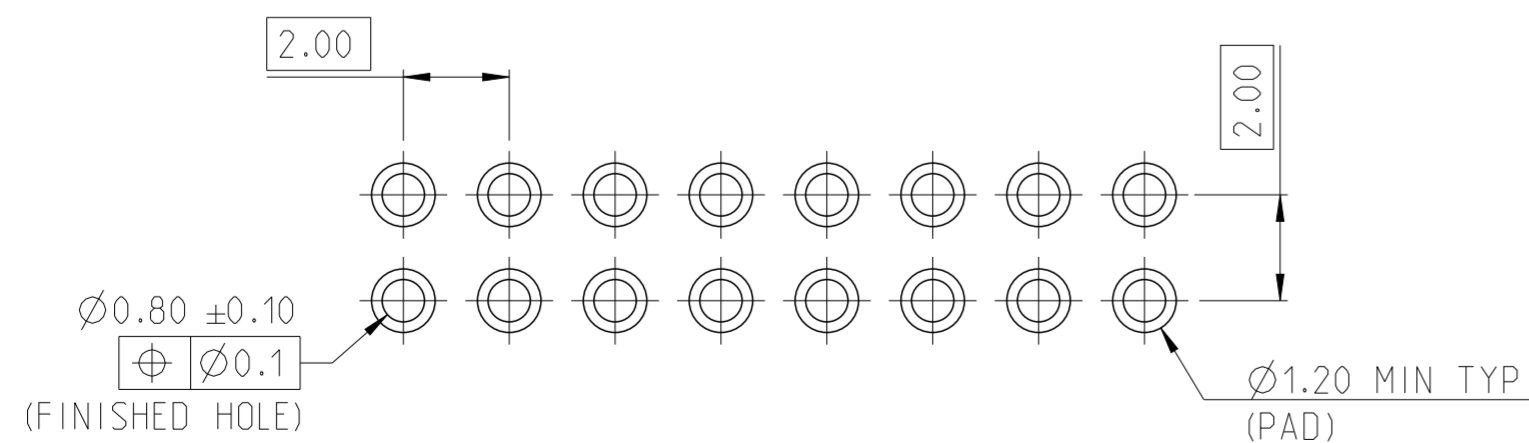

RECOMMENDED PCB HOLE PATTERN FOR THROUGH HOLE REFLOW/PIN-IN-PASTE

2-2842286-0 AS SHOWN

DESCRIPTION	ITEM NO.
PICK AND PLACE CAP	3
CONTACT PIN	2
HOUSING	1

THIS DRAWING IS A CONTROLLED DOCUMENT.

DIMENSIONS:	TOLERANCES UNLESS OTHERWISE SPECIFIED:
mm	
0 PLC	±
1 PLC	±
2 PLC	±0.25
3 PLC	±
4 PLC	±
ANGLES	±2°
FINISH	

DWN	11NOV2019
CHK	25NOV2019
APVD	27NOV2019
NAME	ANKIT YADAV
NAME	KARTHIK JK
NAME	PRASHANTH S.
PRODUCT SPEC	108-64040
APPLICATION SPEC	114-32259
WEIGHT	-
CUSTOMER DRAWING	

STE TE Connectivity	
NAME	AMPMODU 2mm SHROUDED HEADER DUAL ROW, VERTICAL TH. 0.1 Au, TUBE, WITH PICK AND PLACE CAP
SIZE	A2
CAGE CODE	00779
DRAWING NO	C-2842286
RESTRICTED TO	-
SCALE	5:1
SHEET	1 OF 1
REV	A1

单击下面可查看定价，库存，交付和生命周期等信息

[>>TE Connectivity\(泰科\)](#)