

REVISIONS				
P	LTR	DESCRIPTION	DATE	APPV
B		REVISED PER ECO-20-001912	04JUN2020	SB JO

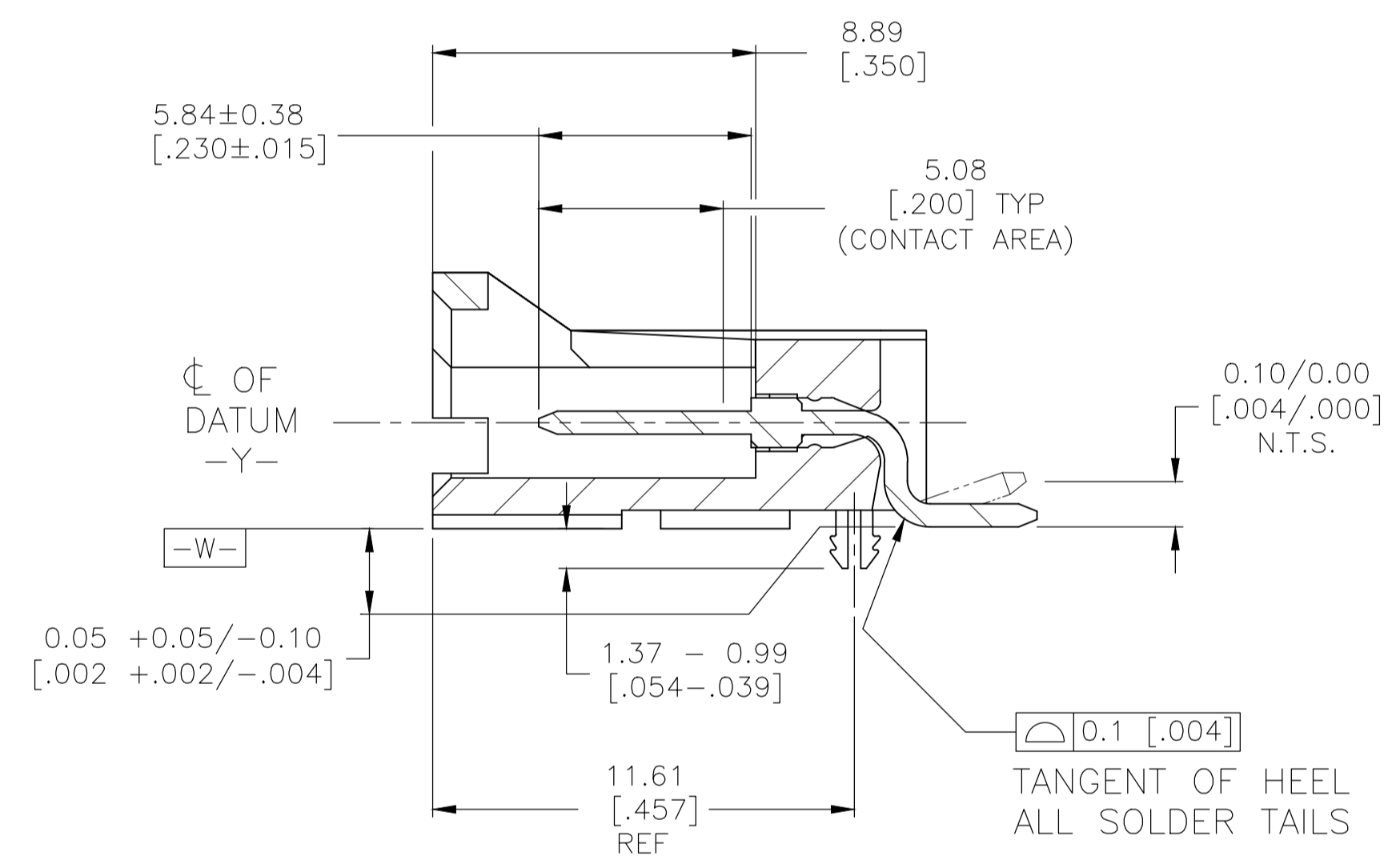

- 1 HOUSING: HIGH TEMPERATURE THERMOPLASTIC, COLOR-BLACK. POST: BRASS.
- 2 POST: 0.000762 [.000030] MIN GOLD ON THE CONTACT AREA, 0.00254-0.00508 [.000100-.000200] MIN MATTE TIN ON THE SOLDER LEADS, ALL OVER 0.00127 [.000050] NICKEL.
- 3 DATUMS AND BASIC DIMENSIONS ESTABLISHED BY THE CUSTOMER.
- 4 TWO POLARIZATION SLOTS ON ASSEMBLIES WITH FOUR OR MORE POSITIONS.
- 5 PACKAGE: TAPE AND REEL PER EIA-481 SPECIFICATIONS. SEE TABLE FOR TAPE WIDTH.
- 6 0.25 [.010] RECESS PERMISSIBLE IN THIS AREA FOR MOLD SHUT OFF

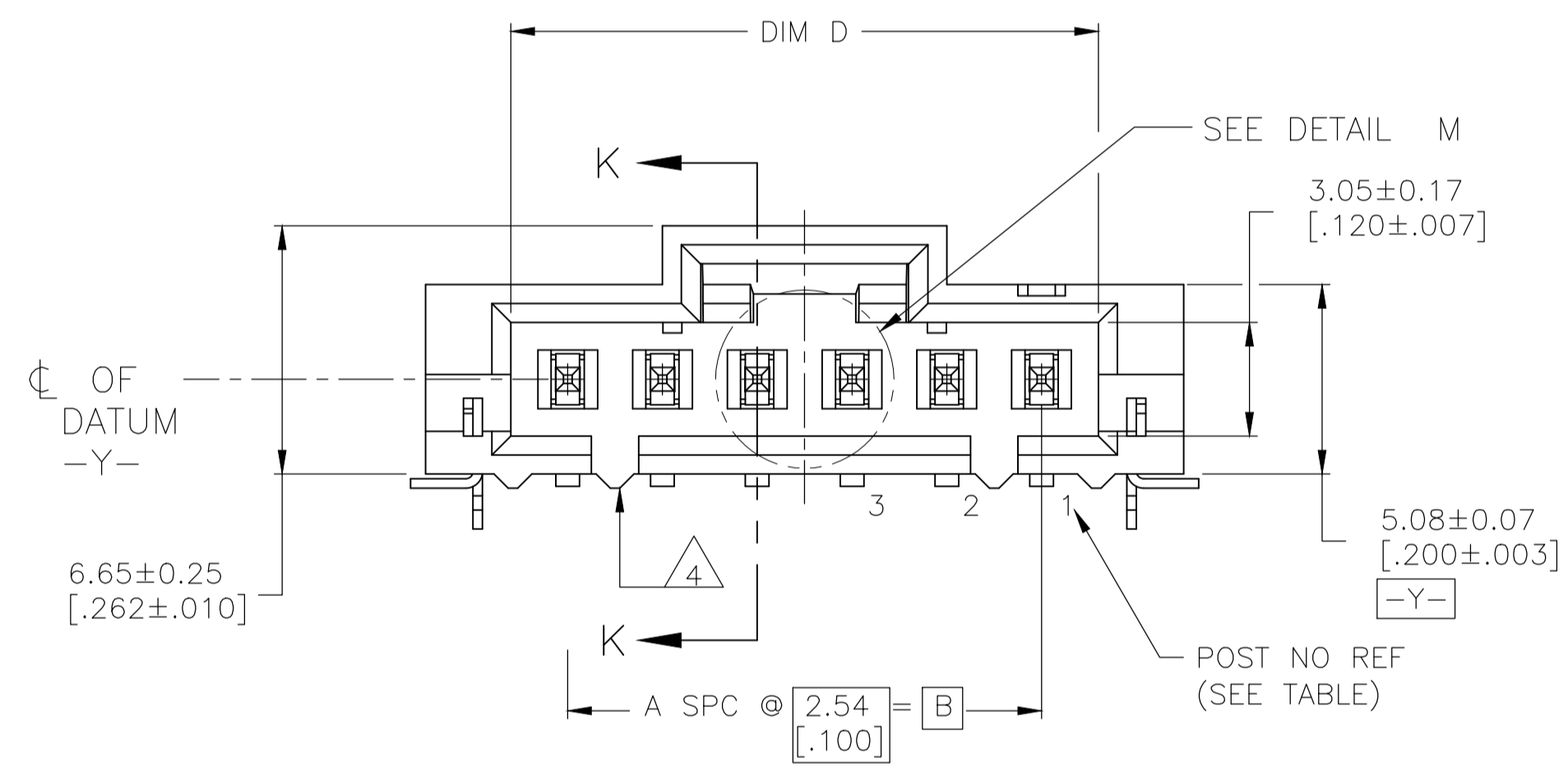
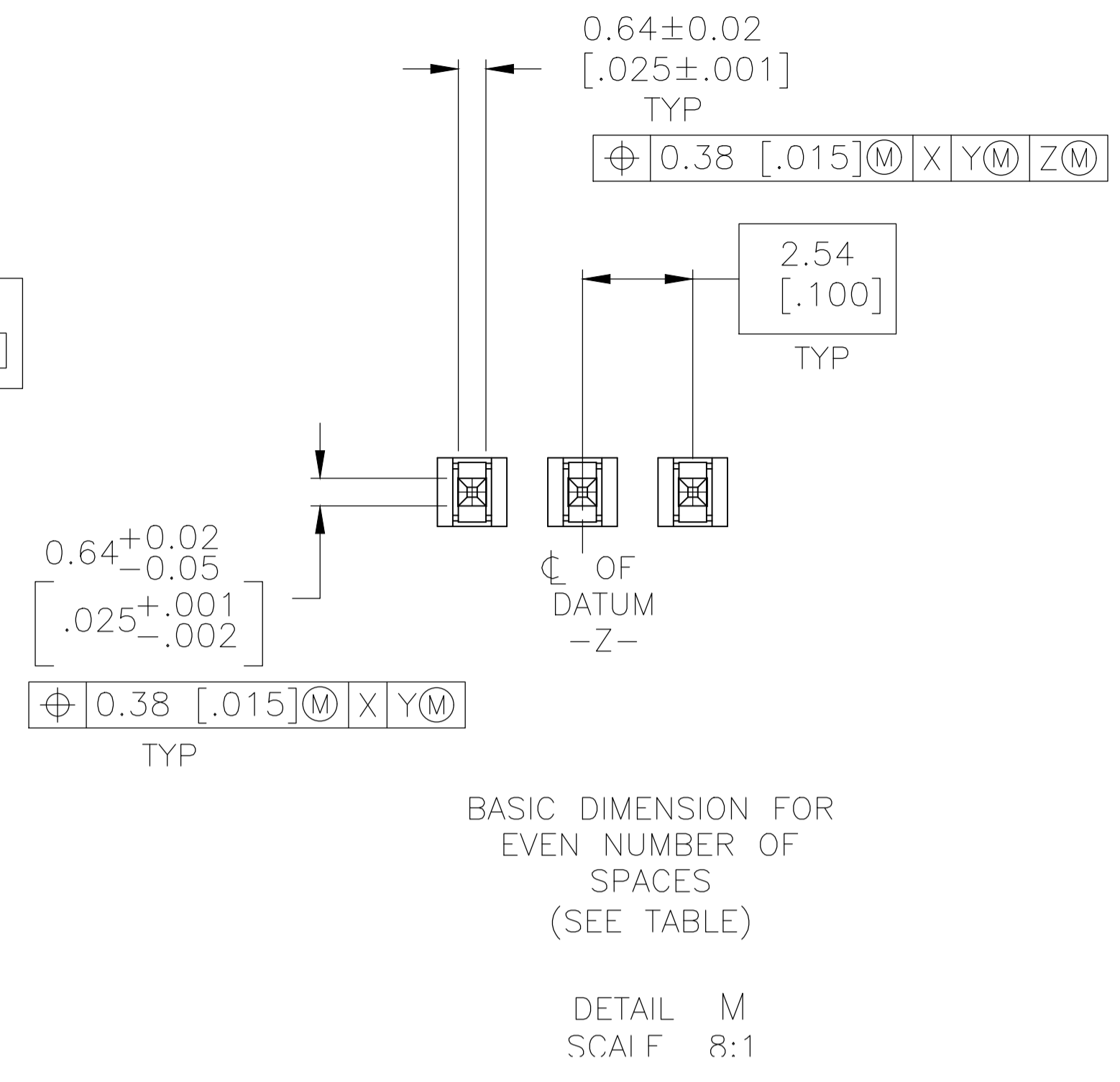
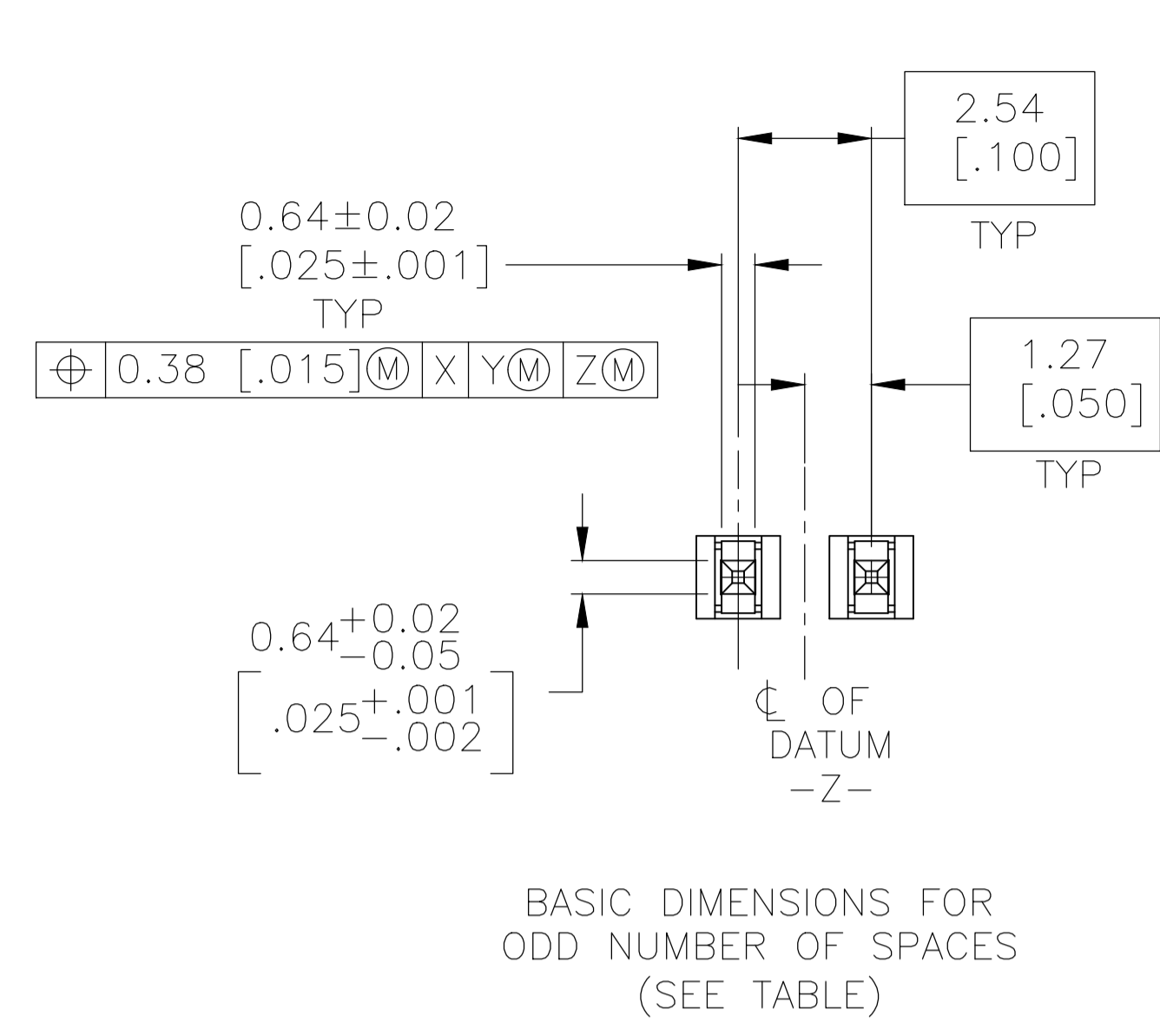
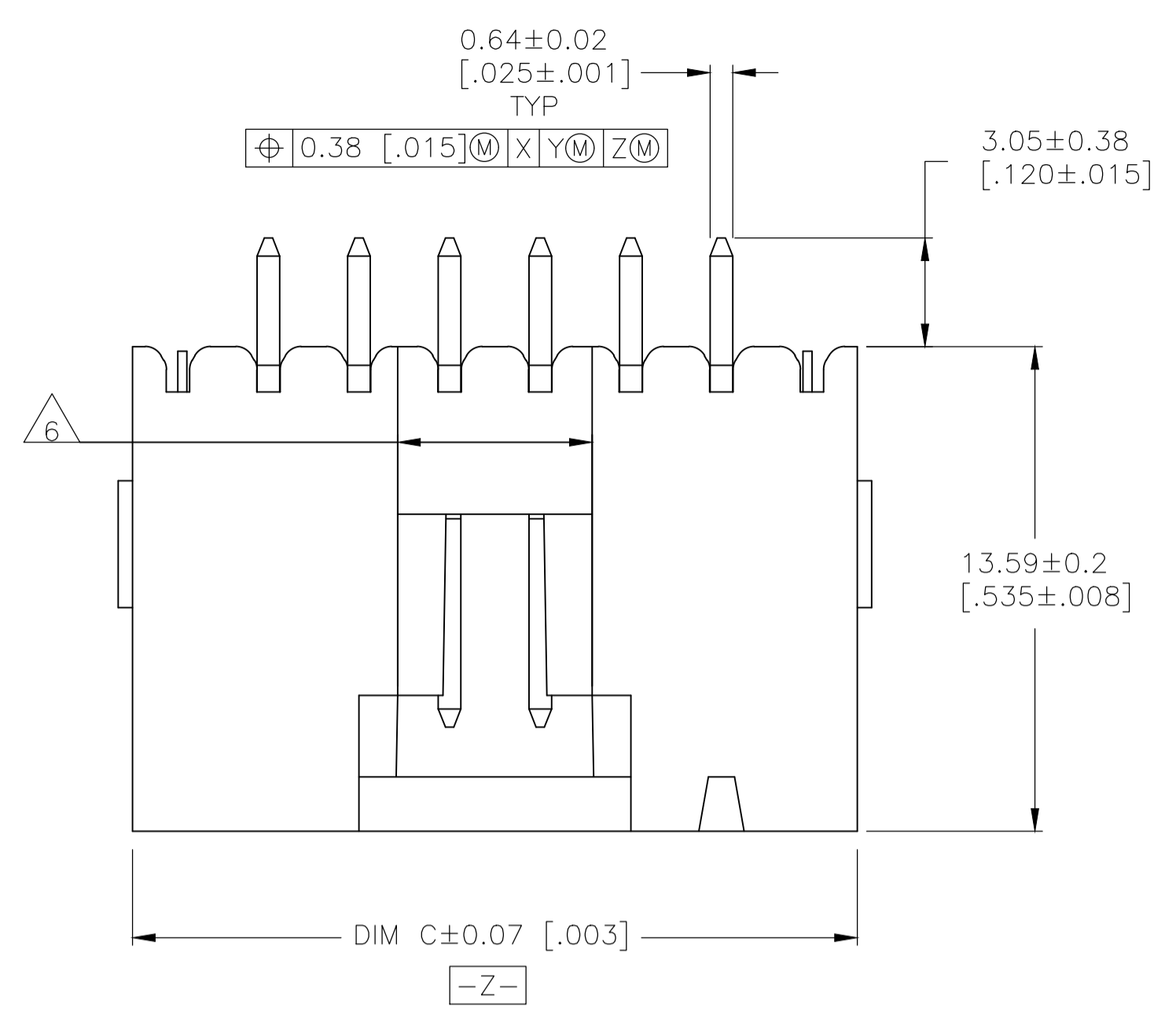
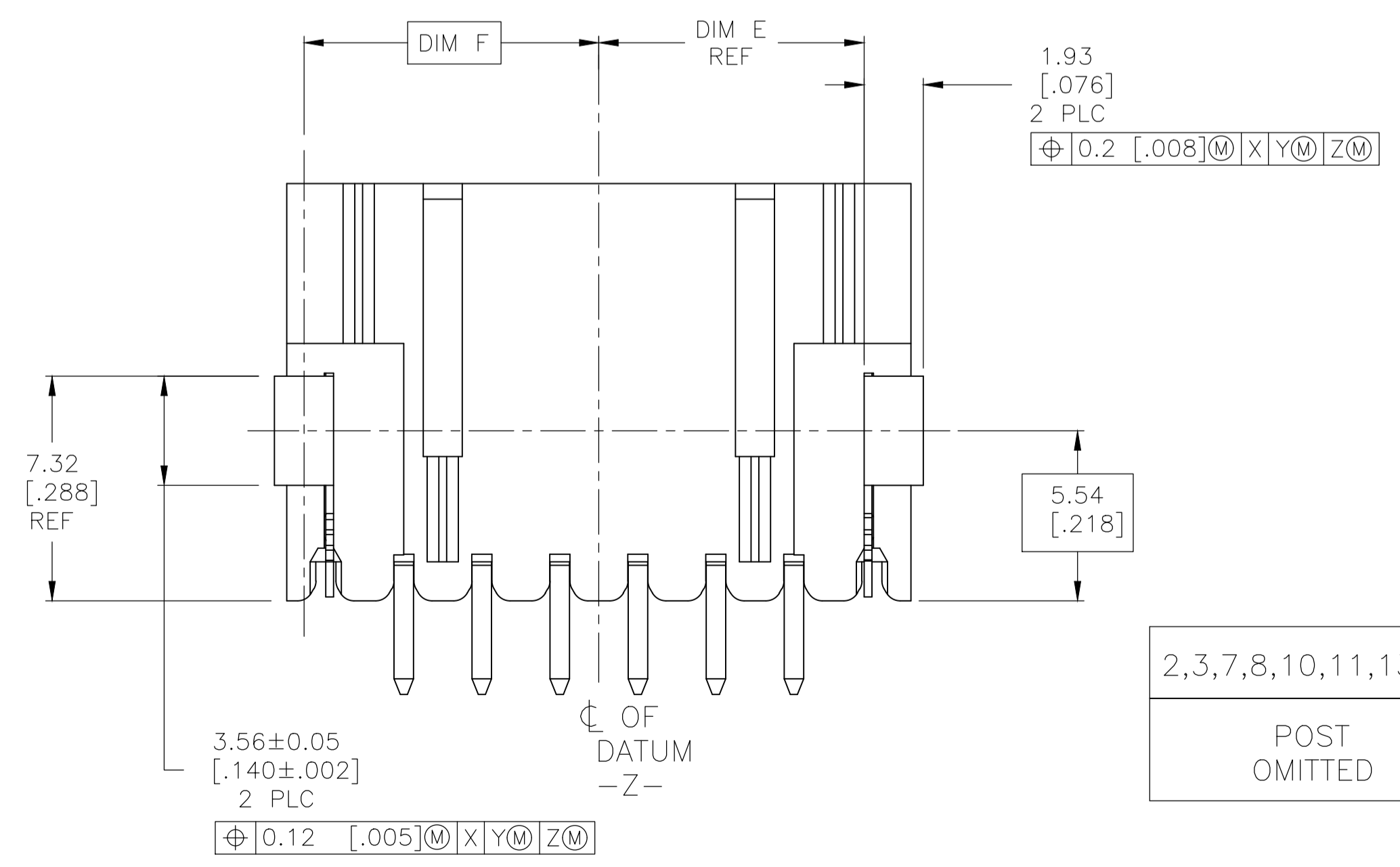

2,3,7,8,10,11,13,14	2	72	40.39 [1.590]	21.03 [.828]	20.07 [.790]	38.61 [1.520]	43.18 [1.700]	35.56 [1.400]	14	15	1825935-1
POST OMITTED	PLATING	EIA 481 TAPE WIDTH mm	G	F	E	D	C	B	A	NO OF POSN	PART NUMBER

THIS DRAWING IS A CONTROLLED DOCUMENT.

DIMENSIONS: mm [INCHES]	TOLERANCES UNLESS OTHERWISE SPECIFIED:	DIN M. BINNER 27NOV06	APVD J. GESFORD 27NOV06
0 PLC ± -	1 PLC ± -	NAME J. GESFORD	NAME J. GESFORD
2 PLC ± -	3 PLC ± 0.13 [.005]	PRODUCT SPEC 108-25034	APPLICATION SPEC
4 PLC ± -	ANGLES ± -	SIZE A1	CAGE CODE 00779
MATERIAL 1	FINISH 2	DRAWING NO 1825935	RESTRICTED TO
CUSTOMER DRAWING		SCALE 6:1	SHEET 1 OF 2

TE Connectivity Ltd.

HEADER ASSEMBLY, LATCHING, RIGHT ANGLE SURFACE MOUNT, MTE, AMPMODU

REVISIONS				
P	LTR	DESCRIPTION	DATE	APPD
-		SEE SHEET 1	-	-

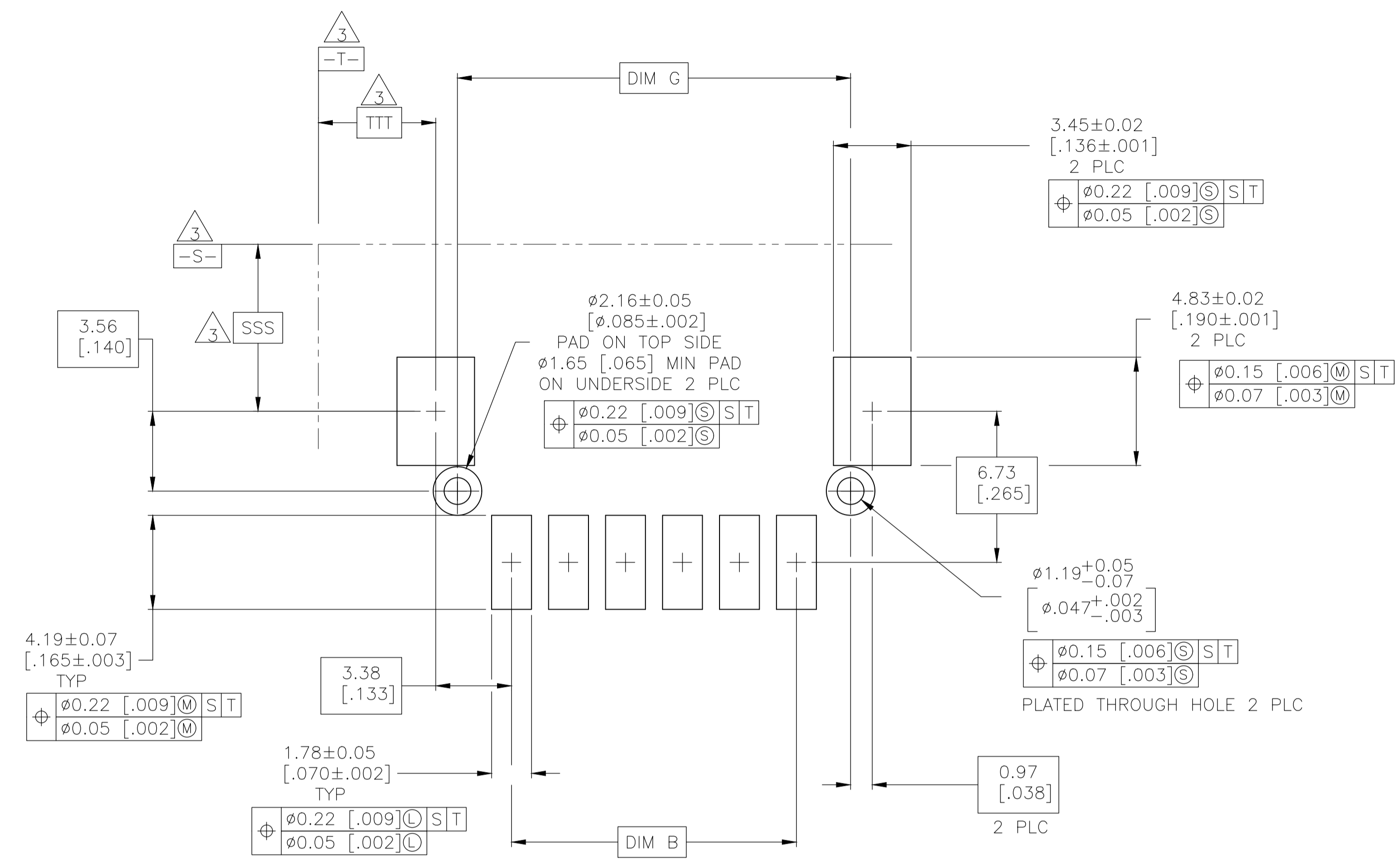

RECOMMENDED PC BOARD LAYOUT

THIS DRAWING IS A CONTROLLED DOCUMENT.		DIN M. BINNER 27NOV06	TE Connectivity Ltd.
DIMENSIONS: mm [INCHES]		CHK J. GESFORD 27NOV06	
TOLERANCES UNLESS OTHERWISE SPECIFIED:		APPD J. GESFORD 27NOV06	NAME HEADER ASSEMBLY, LATCHING, RIGHT ANGLE SURFACE MOUNT, MTE, AMPMODU
0 PLC ± - 1 PLC ± - 2 PLC ± - 3 PLC ± 0.13 [.005] 4 PLC ± - ANGLES ± -		PRODUCT SPEC 108-25034	SIZE A1
MATERIAL 1		FINISH 2	DRAWING NO 1825935
CUSTOMER DRAWING		WEIGHT -	RESTRICTED TO -
		SCALE 6:1	SHEET 2 OF 2
			REV B

单击下面可查看定价，库存，交付和生命周期等信息

[>>TE Connectivity\(泰科\)](#)