

LOC		DIST		REVISIONS			
ES	00	P.	LTH	DESCRIPTION	DATE	DWN	APVD
		L9		REV PER ECR-12-010228	07JUN2012	AY	SZ
		M1		ADD 5-6450130-3	25JUL2012	OL	SZ

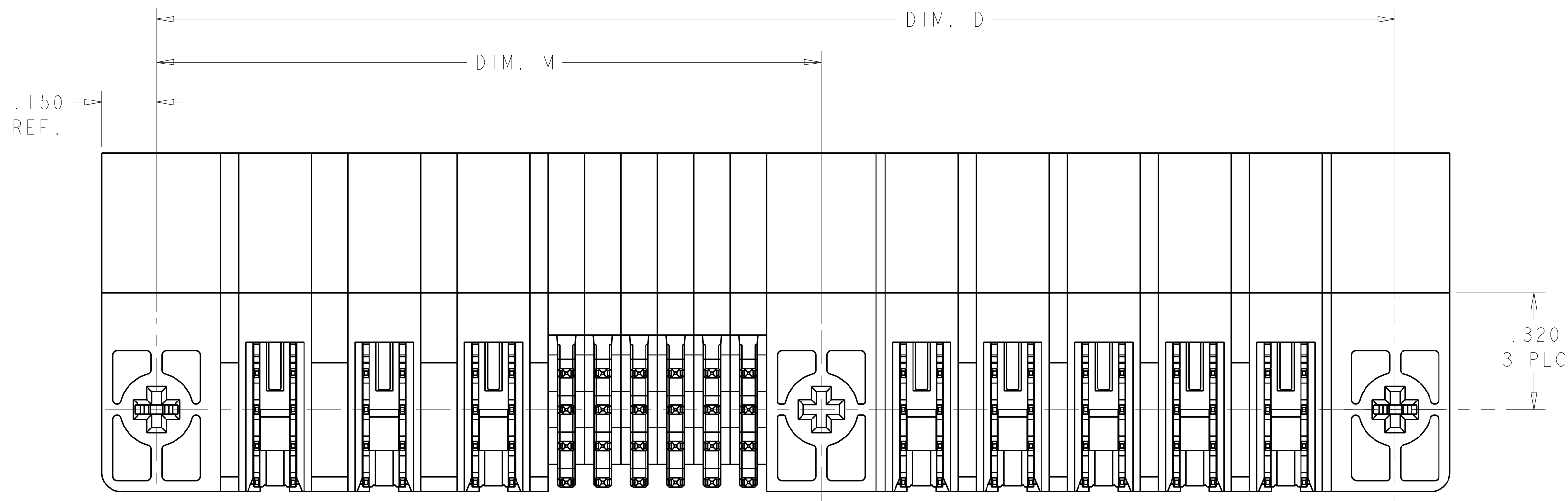
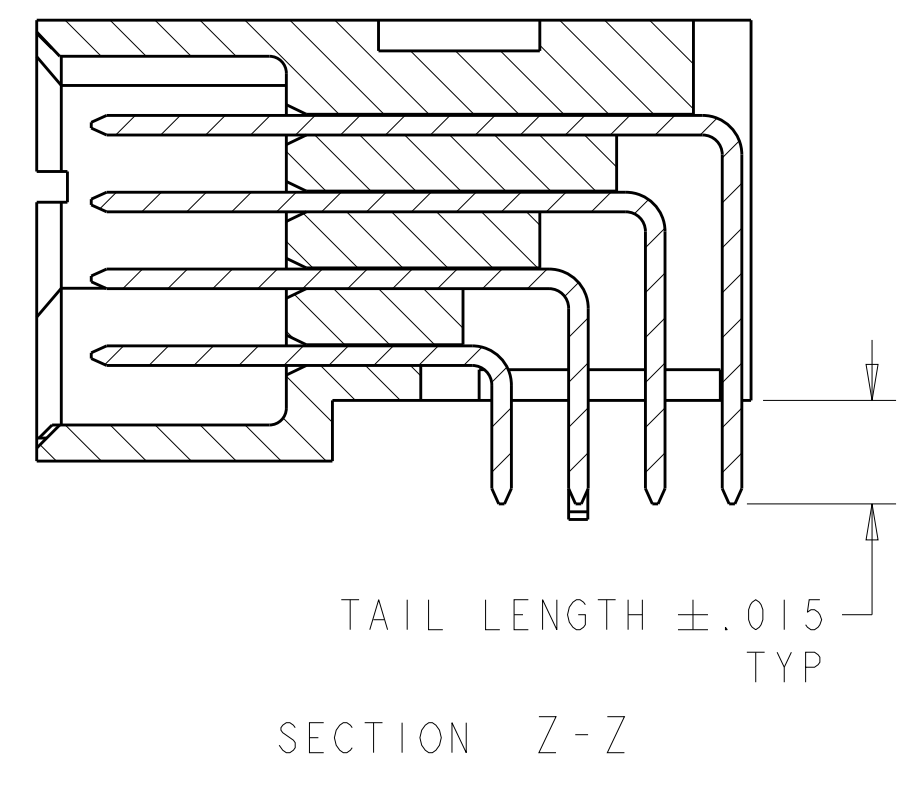
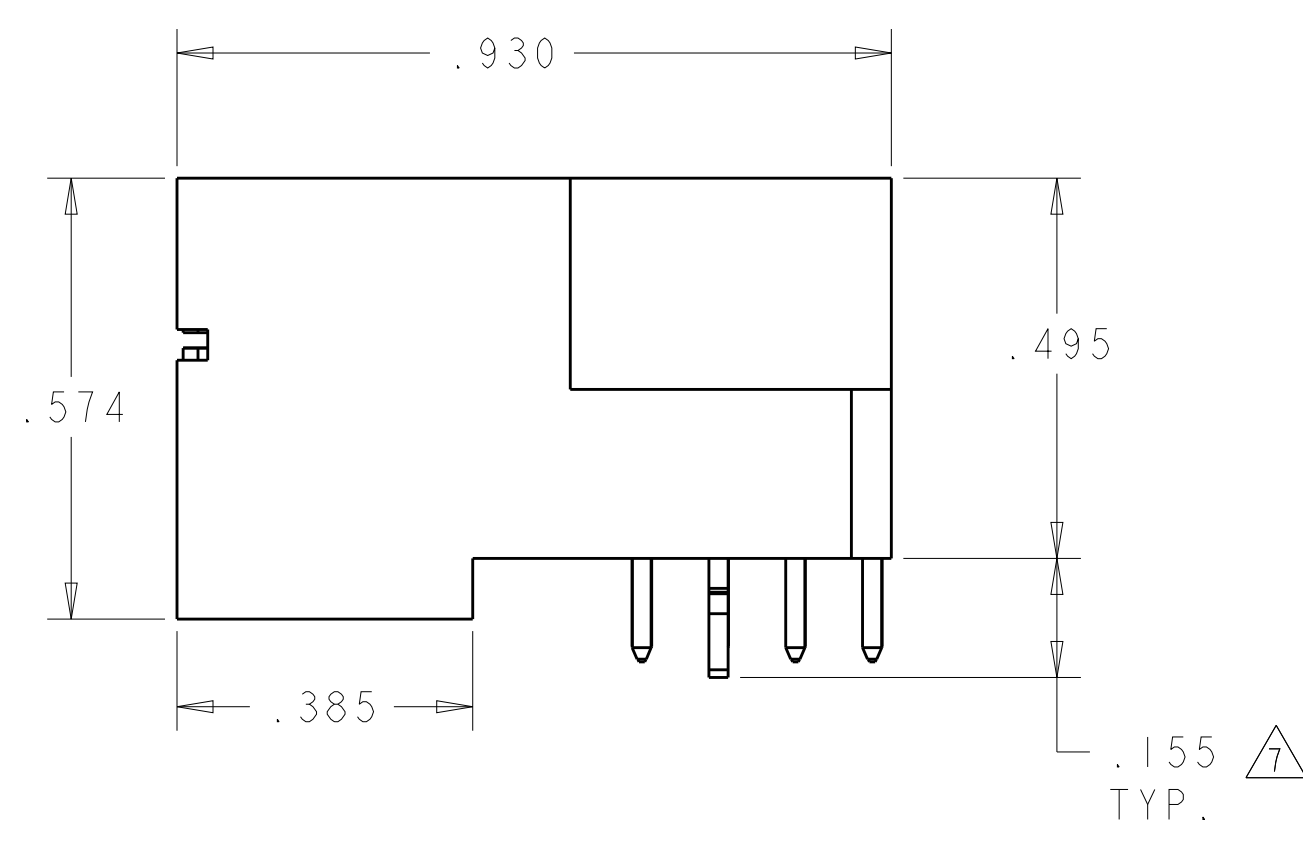
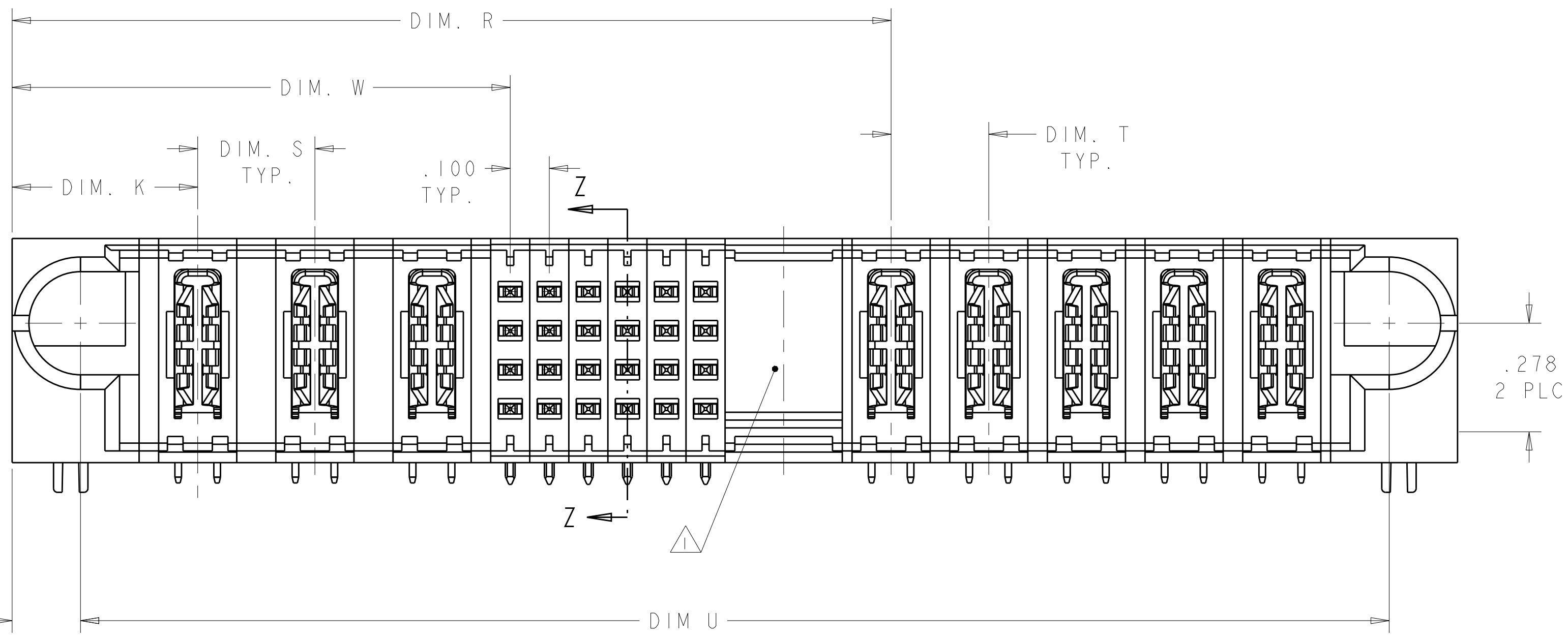
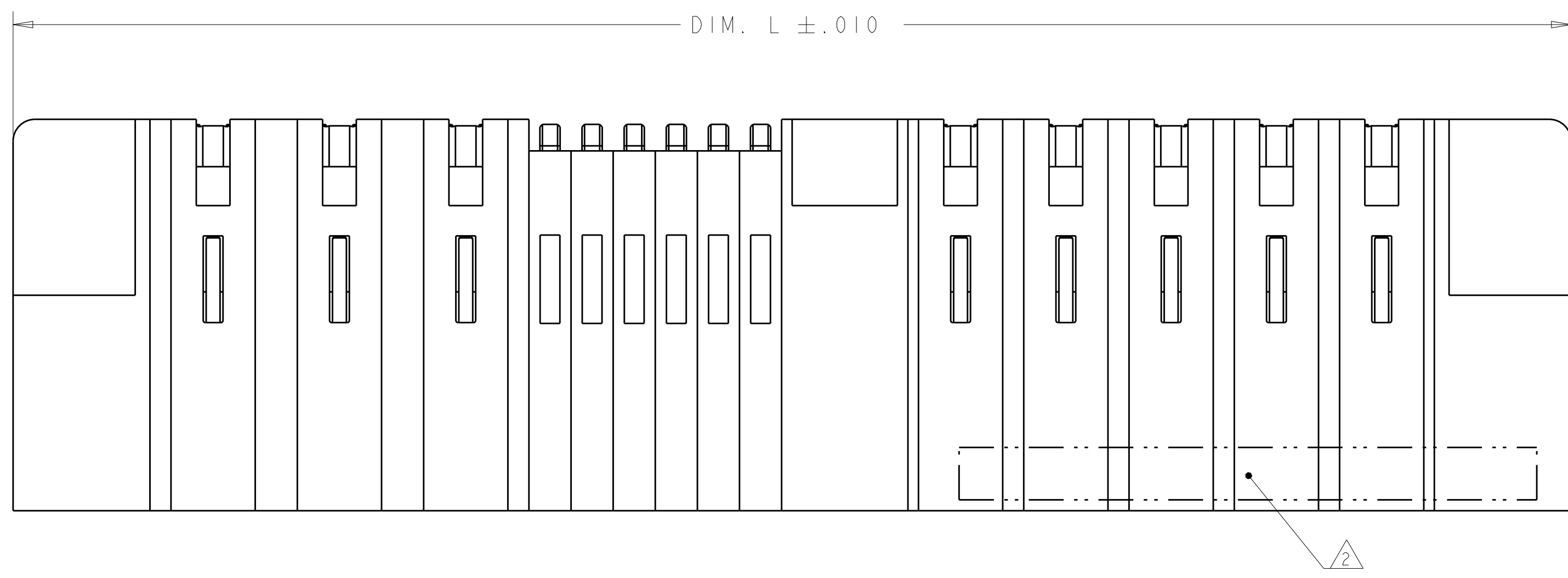

THIS DRAWING IS A CONTROLLED DOCUMENT.

DIMENSIONS: INCHES	TOLERANCES UNLESS OTHERWISE SPECIFIED: 0 PLC ±. 1 PLC ±.01 2 PLC ±.01 3 PLC ±.005 4 PLC ±.0020 ANGLES ±.7°	DWN: R.GRZYBOWSKI 4FEB2005 CHK: M.PERCHEK 14FEB2005 APVD: M.PERCHEK 14FEB2005	TE Connectivity RIGHT ANGLE HEADER ASSEMBLY W/GUIDES MULTI-BEAM XL
MATERIAL: 3	FINISH: 4	PRODUCT SPEC: 108-1973 APPLICATION SPEC: 114-13038 WEIGHT: -	

Customer Drawing SCALE 4:1 SHEET 1 OF 28 REV M2

LOC	DIST	REV	DATE	BY	APPV
ES	00				

- △ OPTIONAL CENTER MODULE WITH Ø.150 THRU HOLE OR HOLD DOWN FEATURE.
- △ "AMP", PART NUMBER, AND DATE CODE TO BE MARKED IN AREA SHOWN.
- △ MATERIAL: HOUSING - GLASS FILLED HIGH TEMP THERMO PLASTIC, UL94 V-0
SIGNAL CONTACT - COPPER ALLOY
POWER CONTACT - HIGH CONDUCTIVITY COPPER ALLOY
- △ CONTACT PLATING: NOBLE METAL PLATING ON CONTACT FUNCTIONAL AREA OF SIGNAL CONTACTS AND POWER CONTACTS.
- △ MECHANICAL CONNECTOR KEEP OUT ZONE.
- △ DATUM AND BASIC DIMENSIONS ESTABLISHED BY CUSTOMER.
- △ HOLD DOWN SEATING DEPTH DIMENSION FOR 6450130-4 IS .185 TYP
- △ PCB - ALL HOLE DIAMETERS ARE FINISHED HOLE SIZES.
- △ PCB - .0453 +/- .0010 DRILLED HOLES PLATES WITH .0003 MIN Sn OVER .001 TO .003 Cu PLATING TO ACHIEVE A .040±.003 DIA HOLE.
- △ VARIABLE DIMS. SHOWN ON VIEW

Ⓛ9 PART IS SHEET 27

DIM U	DIM S	DIM T	DIM R	DIM W	DIM D	DIM M	DIM L	DIM K	DESCRIPTION	PART NUMBER
1.600	-	-	1.500	.625	1.650	-	1.950	.450	1P + 32S + 1P	9-6450130-9
2.400	.250	.250	1.550	.875	2.450	-	2.750	.450	2P + 24S + 4P	9-6450130-8
2.400	.250	.250	1.800	1.125	2.450	-	2.750	.450	3P + 24S + 3P	9-6450130-7
1.300	-	-	1.200	.625	1.350	-	1.650	.450	1P + 20S + 1P	9-6450130-6
2.300	.250	.300	1.575	.875	2.350	-	2.650	.450	2P + 24S + 3ACP	9-6450130-5
2.800	.250	.300	2.075	1.375	2.850	-	3.150	.450	4P + 24S + 3ACP	9-6450130-4
1.700	.250	.250	1.350	.875	1.750	-	2.050	.450	2P + 16S + 2P	9-6450130-3

DIM U	DIM S	DIM T	DIM R	DIM W	DIM D	DIM M	DIM L	DIM K	DESCRIPTION	PART NUMBER
2.350	.250	.250	1.250	.875	2.400	-	2.700	.450	2P + 12S + 5P	9-6450130-2
2.400	.250	.250	1.800	1.125	2.450	-	2.750	.450	3P + 24S + 3P	9-6450130-0
1.200	-	-	1.100	.625	1.250	-	1.550	.450	1P + 16S + 1P	8-6450130-9
1.900	.250	.250	1.550	.875	1.950	-	2.250	.450	2P + 24S + 2P	8-6450130-8
2.900	.250	.250	2.550	.875	2.950	-	3.250	.450	2P + 64S + 2P	8-6450130-7
2.400	.250	.250	1.800	1.125	2.450	-	2.750	.450	3P + 24S + 3P	8-6450130-6
1.300	-	-	1.200	.675	1.350	-	1.650	.450	1P + 16S + 1P	8-6450130-5
2.800	.250	.250	1.700	1.125	2.850	-	3.150	.450	3P + 20S + 5P	8-6450130-4
2.800	.250	.300	2.075	1.375	2.850	-	3.150	.450	4P + 24S + 3ACP	8-6450130-2
2.850	.250	.250	2.500	1.875	2.900	-	3.200	.450	6P + 20S + 2P	8-6450130-0
2.600	.250	.250	2.250	1.625	2.650	-	2.950	.450	5P + 20S + 2P	7-6450130-9
2.400	.250	.250	1.800	1.125	2.450	-	2.750	.450	3P + 24S + 3P	7-6450130-8
4.800	.250	.250	3.450	1.875	4.850	-	5.150	.450	6P + 60S + 6P	7-6450130-7
3.050	.300	.250	1.950	1.275	3.100	-	3.400	.475	3ACP + 24S + 5P	7-6450130-6
2.400	.250	.250	1.800	1.125	2.450	-	2.750	.450	3P + 24S + 3P	7-6450130-5
6.250	.250	△	5.050	4.375	6.300	-	6.600	.450	16P + 24S + 2P + 3ACP	7-6450130-4
2.000	.300	.250	1.650	1.325	2.050	-	2.350	.475	3ACP + 8S + 2P	7-6450130-1
2.500	.250	.250	2.150	.875	2.550	-	2.850	.450	2P + 48S + 2P	6-6450130-9
1.900	.250	.250	1.550	.875	1.950	-	2.250	.450	2P + 24S + 2P	6-6450130-7
2.500	.250	.250	2.150	1.425	2.550	-	2.850	.450	4P + 24S + 2P	5-6450130-8
6.300	△	△	3.925	3.275	6.350	-	6.650	.425	14P + 24S + 12P	5-6450130-6
3.100	.200	.200	2.225	1.375	3.150	-	3.450	.425	5P + 32S + 5P	5-6450130-5
2.400	.200	.200	1.900	1.225	2.450	-	2.750	.450	4HDP + 24S + 3HDP	5-6450130-3
2.300	.300	.250	1.950	1.275	2.350	-	2.650	.450	3ACP + 24S + 2P	5-6450130-1
4.000	.300	.300	2.675	1.925	4.050	-	4.350	.475	5ACP + 24S + 5ACP	5-6450130-0
3.000	.250	.250	2.150	1.425	3.050	-	3.350	.450	4P + 24S + 4P	4-6450130-9
3.300	.250	.250	2.450	1.375	3.350	-	3.650	.450	4P + 40S + 4P	4-6450130-8
3.100	.200	.200	2.225	1.375	3.150	-	3.450	.425	5P + 32S + 5P	4-6450130-5
2.100	.300	.250	1.750	1.275	2.150	-	2.450	.475	3ACP + 16S + 2P	4-6450130-3
1.900	.250	.250	1.550	.875	1.950	-	2.250	.450	2P + 24S + 2P	4-6450130-2
2.100	.200	.200	1.425	1.175	2.150	-	2.450	.425	4P + 8S + 4P	4-6450130-0
2.100	.300	.250	1.750	1.275	2.150	-	2.450	.475	3ACP + 16S + 2P	3-6450130-9
4.675	.250	.300	3.950	3.375	4.725	-	5.025	.450	12P + 20S + 3ACP	3-6450130-6
3.500	.250	.250	2.900	1.625	3.550	-	3.850	.450	5P + 48S + 3P	3-6450130-2
1.900	.250	.250	1.550	.875	1.950	-	2.250	.450	2P + 24S + 2P	2-6450130-9
3.250	.250	.250	2.900	1.125	3.300	-	3.600	.450	3P + 68S + 2P	2-6450130-8
2.300	.300	.250	1.950	1.275	2.350	-	2.650	.475	3ACP + 24S + 2P	2-6450130-6
2.600	.200	.200	1.925	1.175	2.650	-	2.950	.425	4HDP + 28S + 4HDP	2-6450130-4
3.200	.200	.200	2.125	1.575	3.250	-	3.550	.425	6P + 20S + 6P	2-6450130-3
2.800	.250	.300	2.075	1.375	2.850	-	3.150	.450	4P + 24S + 3ACP	2-6450130-2
3.500	.200	.200	2.225	1.775	3.550	-	3.850	.425	7P + 16S + 7P	2-6450130-1
5.450	△	△	3.075	2.425	5.500	-	5.800	.425	10P + 24S + 12P	2-6450130-0
4.400	.250	.250	4.050	.875	4.450	-	4.750	.450	2P + 124S + 2P	1-6450130-9
4.275	△	.250	3.175	2.500	4.325	-	4.625	.475	2ACP + 6P + 24S + 5P	1-6450130-8
1.900	.250	.250	1.550	.875	1.950	-	2.250	.450	2P + 24S + 2P	1-6450130-7
3.300	.300	.250	1.950	1.275	3.350	-	3.650	.475	3ACP + 24S + 6P	1-6450130-4
4.050	.250	-	3.950	.875	4.100	-	4.400	.450	2P + 120S + 1P	1-6450130-3
3.250	.250	-	3.150	.875	3.300	-	3.600	.450	2P + 88S + 1P	1-6450130-2
1.400	-	-	1.300	.625	1.450	-	1.750	.450	1P + 24S + 1P	1-6450130-1
2.900	.250	.250	2.550	.875	2.950	-	3.250	.450	2P + 64S + 2P	1-6450130-0
2.550	.250	.300	1.825	1.125	2.600	-	2.900	.450	3P + 24S + 3ACP	6450130-9
2.675	.200	.200	2.375	1.650	2.725	-	3.025	.450	5P + 24S + 2P	6450130-8
3.650	.250	.250	2.550	1.875	3.700	-	4.000	.450	6P + 24S + 5P	6450130-7
2.400	.250	.250	1.800	1.125	2.450	-	2.750	.450	3P + 24S + 3P	6450130-6
4.350	.250	.250	3.500	2.625	4.400	-	4.700	.450	9P + 32S + 4P	6450130-5
2.800	.250	.300	2.075	1.375	2.850	-	3.150	.450	4P + 24S + 3ACP	6450130-4
3.050	.300	.250	1.950	1.275	3.100	-	3.400	.475	3ACP + 24S + 5P	6450130-3
2.550	.300	.250	2.200	1.525	2.600	-	2.900	.475	3ACP + 1P + 24S + 2P	6450130-2
3.650	.300	.250	2.550	1.275	3.700	-	4.000	.475	3ACP + 48S + 5P	6450130-1

THIS DRAWING IS A CONTROLLED DOCUMENT.

DRN: R. GRZYBOWSKI 4FEB2005
CHK: M. PERCHERKE 14FEB2005
APPV: M. PERCHERKE 14FEB2005

DIMENSIONS: INCHES
TOLERANCES UNLESS OTHERWISE SPECIFIED:
0 PLC ±.01
1 PLC ±.01
2 PLC ±.01
3 PLC ±.005
4 PLC ±.002
ANGLES ±.002

MATERIAL: FINISH: *P

Customer Drawing

TE Connectivity
RIGHT ANGLE HEADER ASSEMBLY W/GUIDES MULTI-BEAM XL

SIZE: 108-1973
APPLICATION SPEC: 114-13038

SCALE: 4:1 SHEET 2 OF 28 REV: M2

PART NUMBER	ROWS	POWER			SIGNAL								POWER										
		P1	P2	P3	1	2	3	4	5	6	7	8	9	10	11	12	P4	P5	P6	P7	P8		
6450130-1	D C B A	PM	PM	PM	J	J	J	J	J	J	J	J	J	J	J	J	PM	PM	PM	PM	PM	PM	PM
					K	K	K	K	K	K	K	K	K	K	K	K							
					N	N	N	N	N	N	N	N	N	N	N	N							
3ACP + 48S + 5P																							

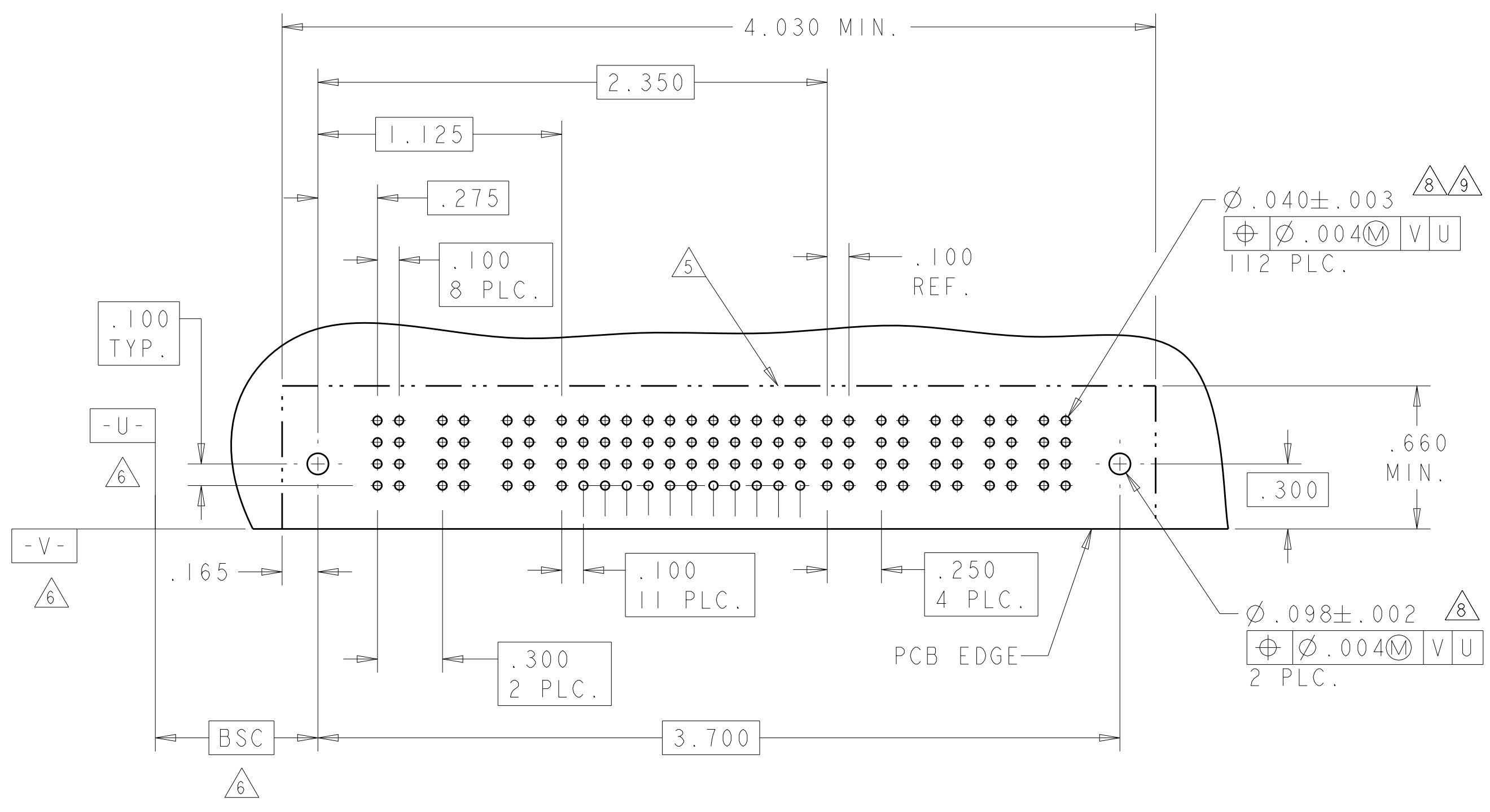

NO CONTACT LOADED

PART NUMBER	ROWS	POWER				SIGNAL						POWER	
		P1	P2	P3	P4	1	2	3	4	5	6	P5	P6
6450130-2	D C B A	PM	PM	PM	PM	E	J	J	J	J	E	PM	PM
						K	K	F	K	K	K		
						N	N	N	N	N	N		
3ACP + 1P + 24S + 2P													

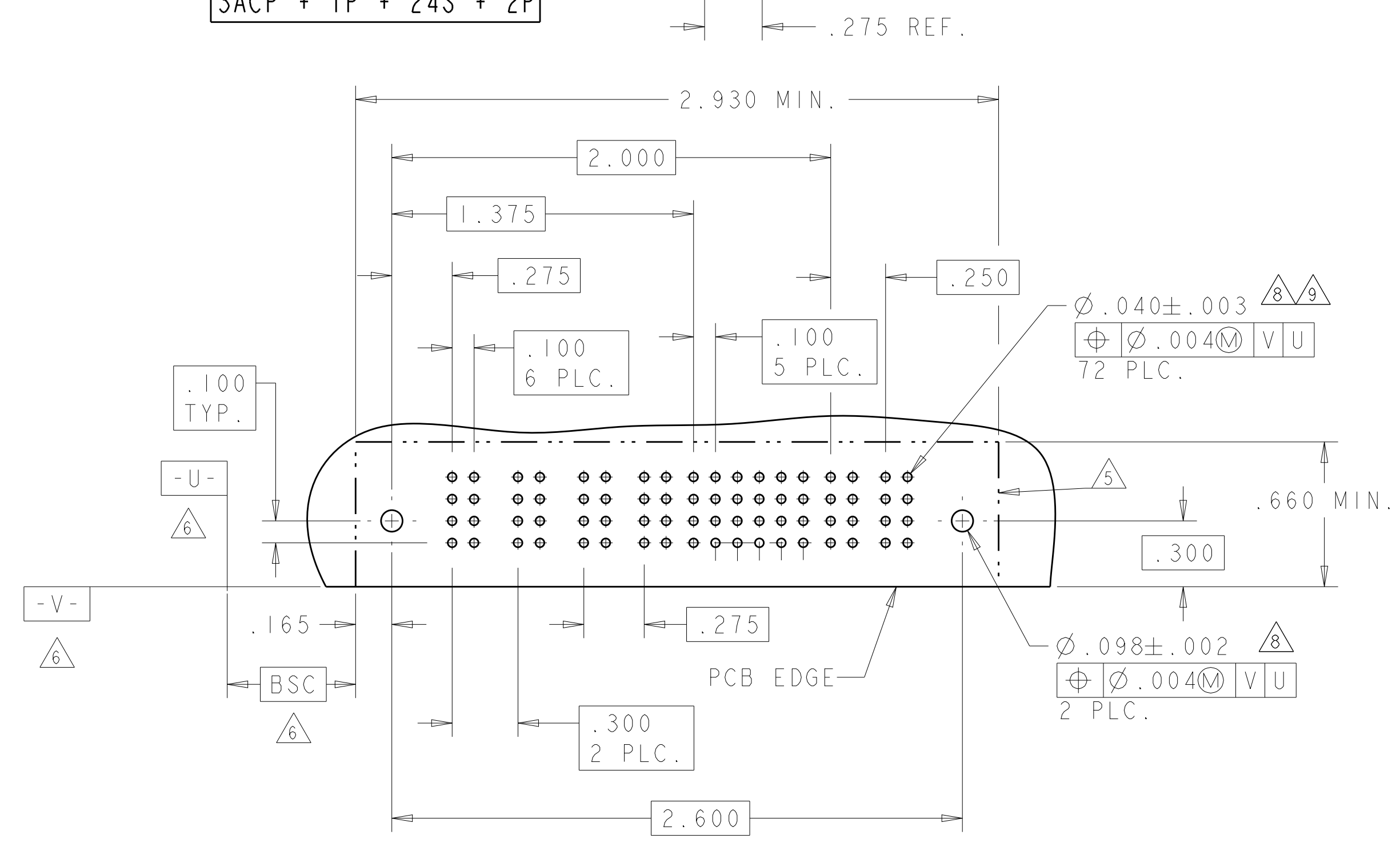

LOC	DIST	REV	DATE	BY	APPV
ES	00				

PART NUMBER	ROWS	POWER			SIGNAL						POWER					
		P1	P2	P3	1	2	3	4	5	6	P4	P5	P6	P7	P8	
6450130-3	D C B A	PM	PM	PM	J	J	J	J	E	J	PM	PM	PM	PM	PM	PM
					K	K	F	K	K	K						
					N	N	N	N	N	G						
3ACP + 24S + 5P																

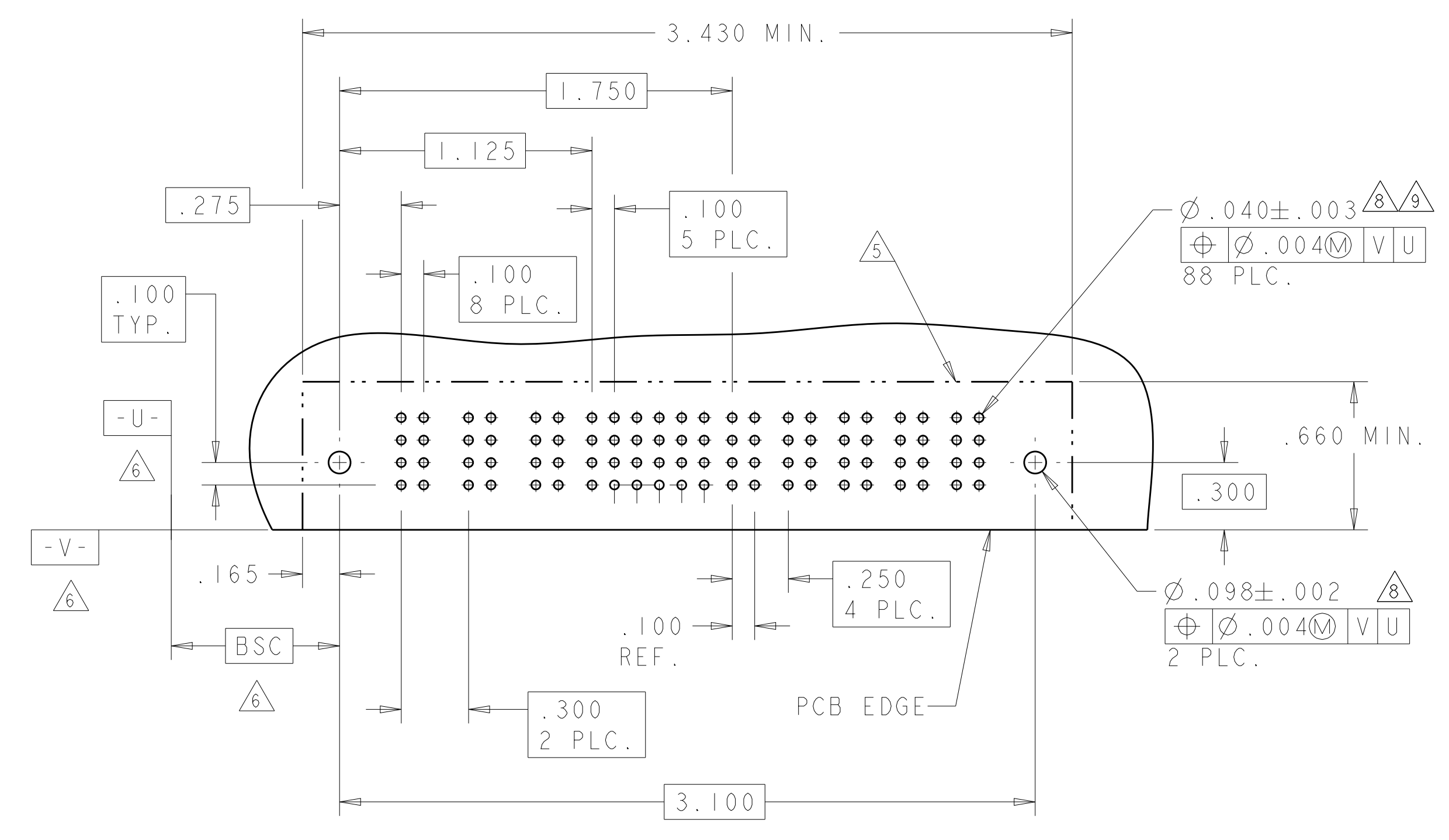

CODE	TAIL LENGTH	DESCRIPTION
PM	.135	MULTI-BEAM
PA	.090	MULTI-BEAM
POWER CONTACT		

CODE	MATING SEQUENCE	TAIL LENGTH	ROW
Z	STD	.090	D
Y	STD	.090	C
R	STD	.090	B
O	STD	.090	A
A4	MLBF	.090	D
A3	MLBF	.090	C
A2	MLBF	.090	B
A1	MLBF	.090	A
E	MLBF	.135	D
F	MLBF	.135	C
G	MLBF	.135	B
H	MLBF	.135	A
J	STD	.135	D
K	STD	.135	C
N	STD	.135	B
S	STD	.135	A
SIGNAL CONTACT			

THIS DRAWING IS A CONTROLLED DOCUMENT. DIMENSIONS: INCHES. TOLERANCES UNLESS OTHERWISE SPECIFIED: 0 PLC ±.01, 1 PLC ±.01, 2 PLC ±.01, 3 PLC ±.005, 4 PLC ±.002, ANGLES ±.020. MATERIAL: FINISH: .

OWN: R. GRZYBOWSKI 14FEB2005, CHK: M. PERCHERKE 14FEB2005, APVD: M. PERCHERKE 14FEB2005. PRODUCT SPEC: 108-1973, APPLICATION SPEC: 114-13038, WEIGHT: .

Customer Drawing. SCALE: 4:1. SHEET 3 OF 28. REV: M2.

STE TE Connectivity
RIGHT ANGLE HEADER ASSEMBLY W/GUIDES MULTI-BEAM XL

SIZE: A100779. CAGE CODE: 6450130. DRAWING NO: 108-1973. APPLICATION SPEC: 114-13038. WEIGHT: .

PART NUMBER	ROWS	POWER				SIGNAL						POWER		
		P1	P2	P3	P4	1	2	3	4	5	6	P5	P6	P7
6450130-4	D C B A	PM	PM	PM	PM	J	J	J	J	J	J	PM	PM	PM
						K	K	K	K	K	K			
						N	N	N	N	N	N			
						S	S	S	S	S	H			
4P + 24S + 3ACP														

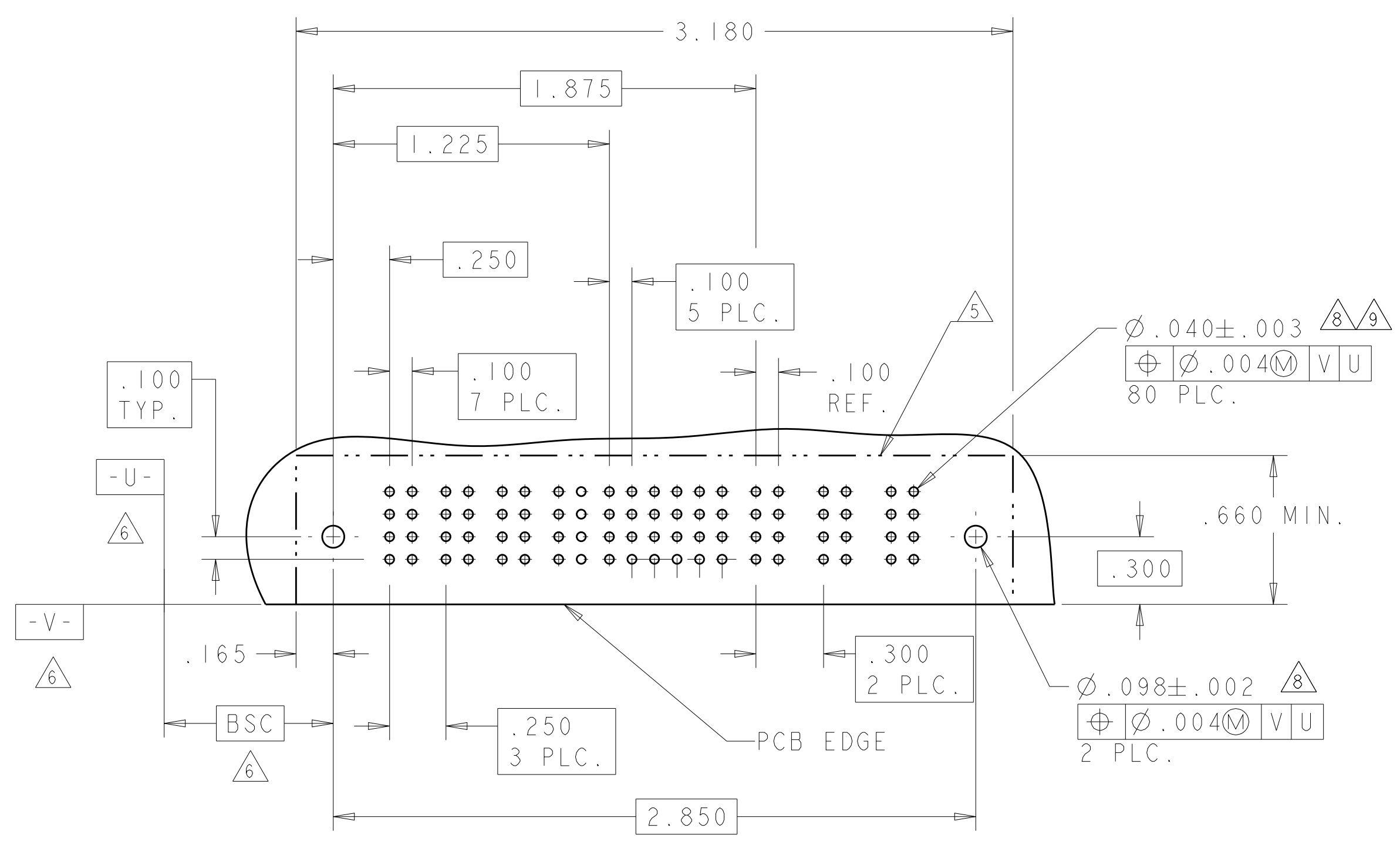

LOC	DIST	REVISIONS		
ES	00	REV	DATE	BY
		SEE SHEET 1		

PART NUMBER	ROWS	POWER			SIGNAL						POWER		
		P1	P2	P3	1	2	3	4	5	6	P4	P5	P6
6450130-6	D C B A	PM	PM	PM	J	J	J	J	J	J	PM	PM	PM
					K	K	K	K	K	K			
					N	N	G	N	N	N			
					S	S	S	S	S	S			
3P + 24S + 3P													

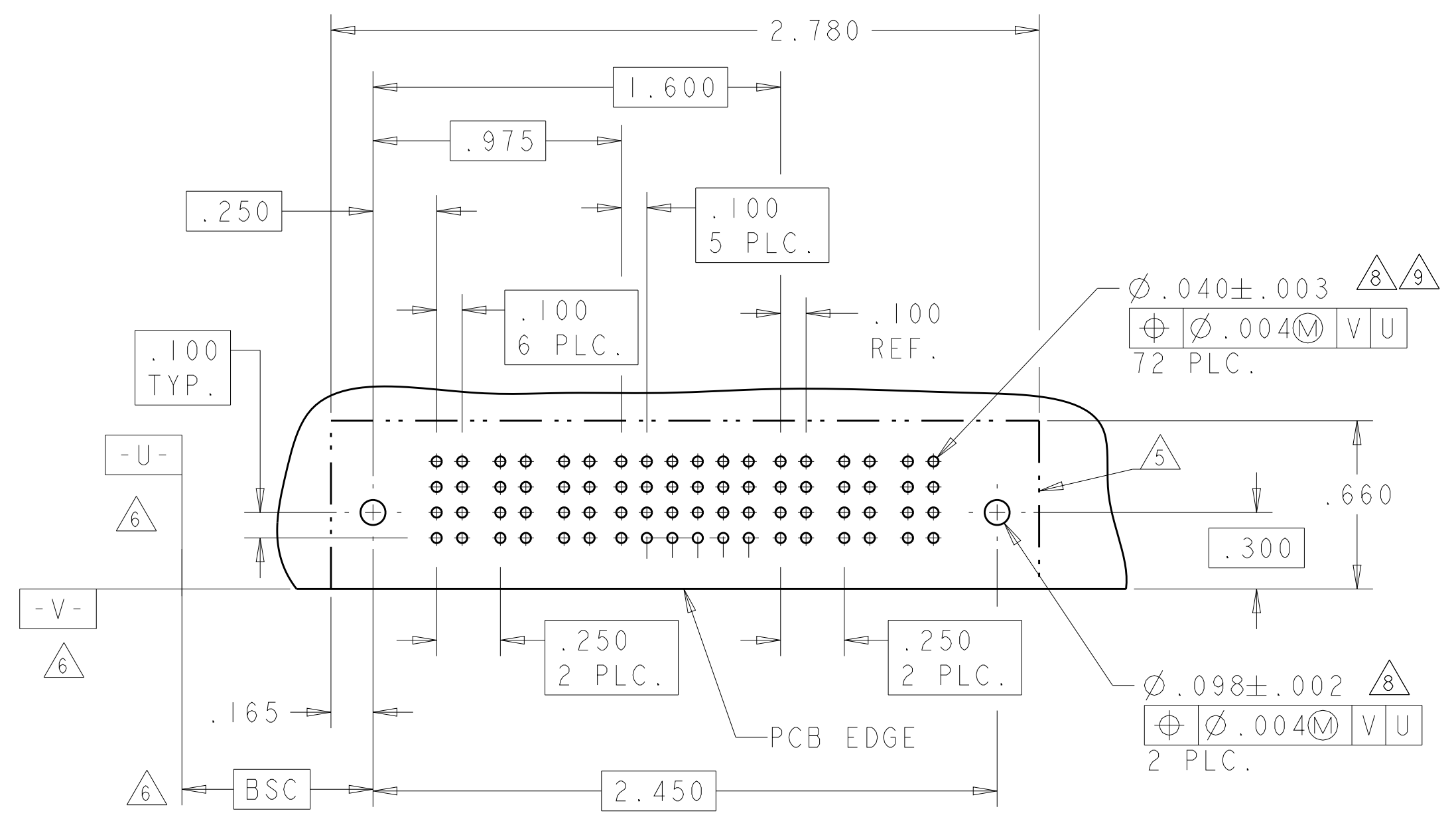

NO CONTACT LOADED

PART NUMBER	ROWS	POWER									SIGNAL								POWER									
		P1	P2	P3	P4	P5	P6	P7	P8	P9	1	2	3	4	5	6	7	8	P10	P11	P12	P13						
6450130-5	D C B A	PM	PM	PM	PM	PM	PM	PM	PM	PM	J	J	J	J	J	J	J	J	J	J	J	J	PM	PM	PM	PM		
											K	K	K	K	K	K	K	K	K	K	K	K					K	
											N	N	N	N	N	N	N	N	N	N	N	N					N	N
											S	S	S	S	S	S	S	S	S	S	S	S					S	S
9P + 32S + 4P																												

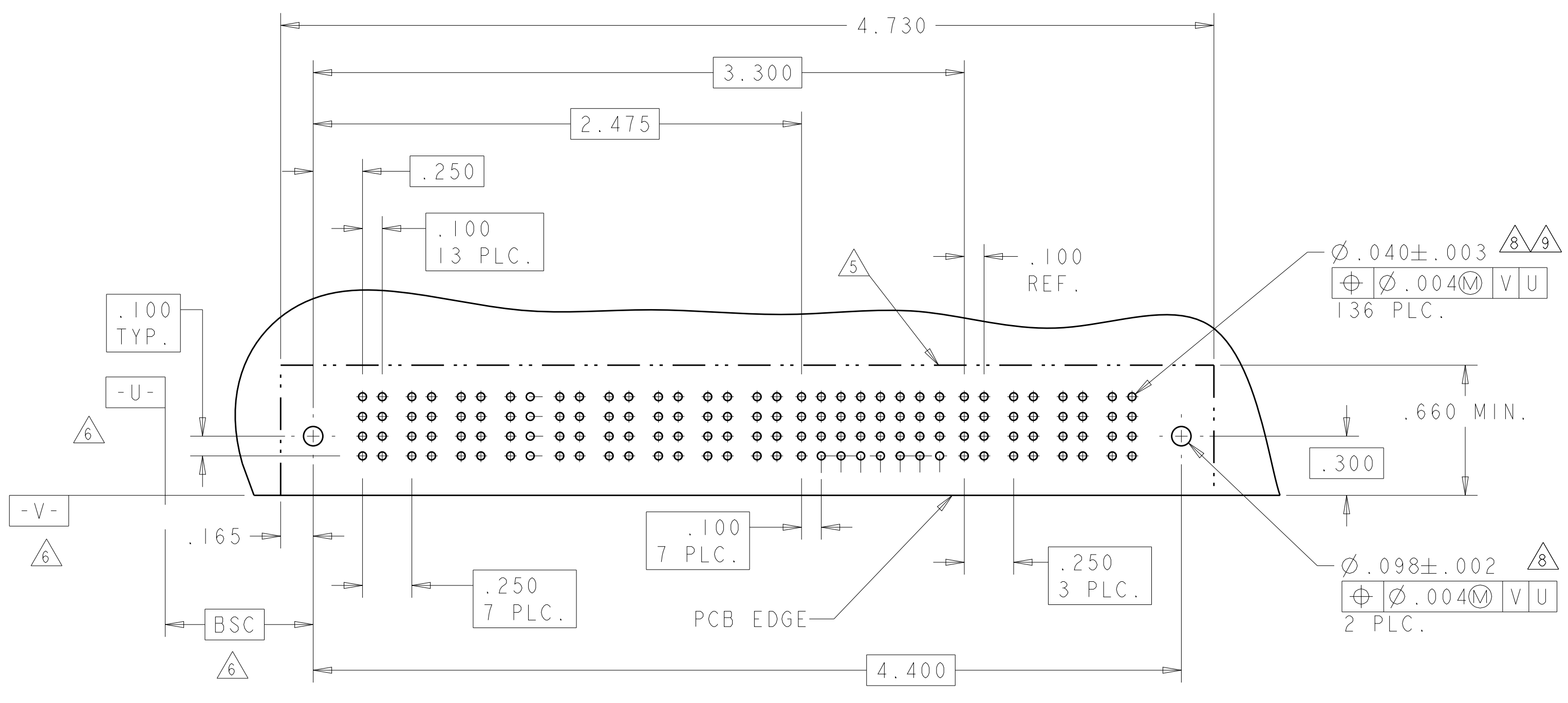

PART NUMBER	ROWS	POWER						SIGNAL						POWER				
		P1	P2	P3	P4	P5	P6	1	2	3	4	5	6	P7	P8	P9	P10	P11
6450130-7	D C B A	PM	PM	PM	PM	PM	PM	J	J	J	J	J	J	PM	PM	PM	PM	PM
								K	K	F	K	K	K					
								N	N	N	N	N	G					
								S	S	H	S	S	S					
6P + 24S + 5P																		

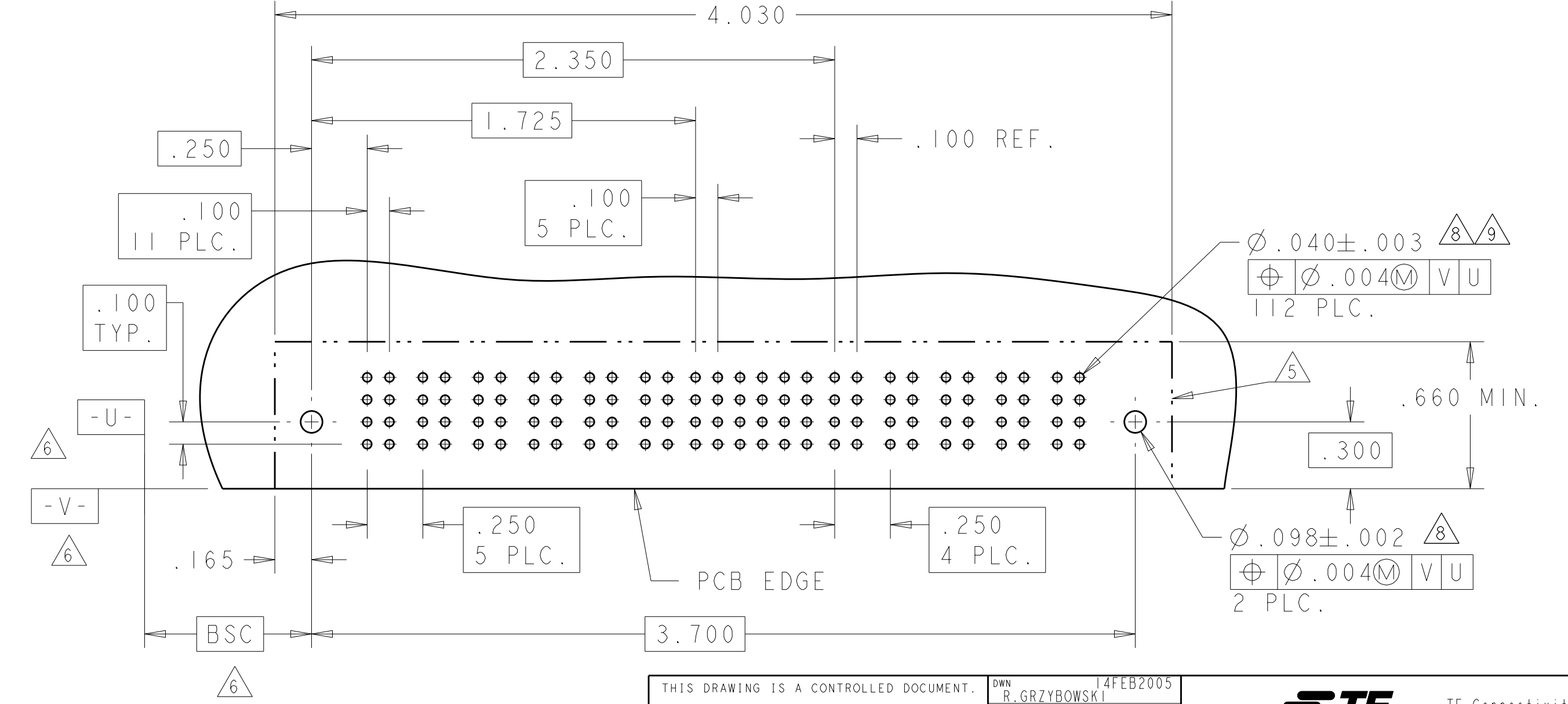

THIS DRAWING IS A CONTROLLED DOCUMENT. DIMENSIONS: INCHES. TOLERANCES UNLESS OTHERWISE SPECIFIED: 0 PLC ±.01, 1 PLC ±.01, 2 PLC ±.01, 3 PLC ±.005, 4 PLC ±.002, ANGLES ±.002. MATERIAL: FINISH: .

OWN: R. GRZYBOWSKI 14FEB2005
CHK: M. PERCHERKE 14FEB2005
APVD: M. PERCHERKE 14FEB2005

PRODUCT SPEC: 108-1973
APPLICATION SPEC: 114-13038

NAME: RIGHT ANGLE HEADER ASSEMBLY W/GUIDES MULTI-BEAM XL
SIZE: A1
CAGE CODE: 100779
DRAWING NO: 6450130
SHEET 4 OF 28
REV: M2

Customer Drawing SCALE: 4:1

LOC	DIST	REVISIONS					
ES	00	P	LTH	DESCRIPTION	DATE	OWN	APVD
		-		SEE SHEET 1			

PART NUMBER	ROWS	POWER							SIGNAL						POWER									
		P1	P2	P3	P4	P5	P6	P7	P8	1	2	3	4	5	6	P9	P10	P11	P12	P13	P3	P4		
I-6450130-8	D	PM	PM	PM	PM	PM	PM	PM	E	J	J	J	J	E	PM	PM	PM	PM	PM	PM	PM			
	K								K	F	K	K	K	PM								PM	PM	PM
	N								N	N	G	N	N											
	H								S	S	S	S	H											
C	PM	PM	PM	PM	PM	PM	PM	PM	PM	PM	PM	PM	PM	PM	PM	PM	PM	PM	PM	PM				
B																								
A																								
HD																								

PART NUMBER	ROWS	POWER		SIGNAL																															POWER				
		P1	P2	1	2	3	4	5	6	7	8	9	10	11	12	13	14	15	16	17	18	19	20	21	22	23	24	25	26	27	28	29	30	31	P3	P4			
I-6450130-9	D	PA	PA	Z	A4	A4	A4	A4	A4	A4	A4	A4	A4	A4	A4	A4	A4	A4	A4	A4	A4	A4	A4	A4	A4	A4	A4	A4	A4	A4	A4	A4	A4	A4	Z	PA	PA		
	Y			A3	A3	A3	A3	A3	A3	A3	A3	A3	A3	A3	A3	A3	A3	A3	A3	A3	A3	A3	A3	A3	A3	A3	A3	A3	A3	A3	A3	A3	A3	A3	A3			Y	
	R			A2	A2	A2	A2	A2	A2	A2	A2	A2	A2	A2	A2	A2	A2	A2	A2	A2	A2	A2	A2	A2	A2	A2	A2	A2	A2	A2	A2	A2	A2	A2	A2			A2	R
	A			A1	A1	A1	A1	A1	A1	A1	A1	A1	A1	A1	A1	A1	A1	A1	A1	A1	A1	A1	A1	A1	A1	A1	A1	A1	A1	A1	A1	A1	A1	A1	A1			A1	A1
C	PA	PA	PA	PA	PA	PA	PA	PA	PA	PA	PA	PA	PA	PA	PA	PA	PA	PA	PA	PA	PA	PA	PA	PA	PA	PA	PA	PA	PA	PA	PA	PA	PA	PA	PA	PA	PA		
B																																							
A																																							
HD																																							

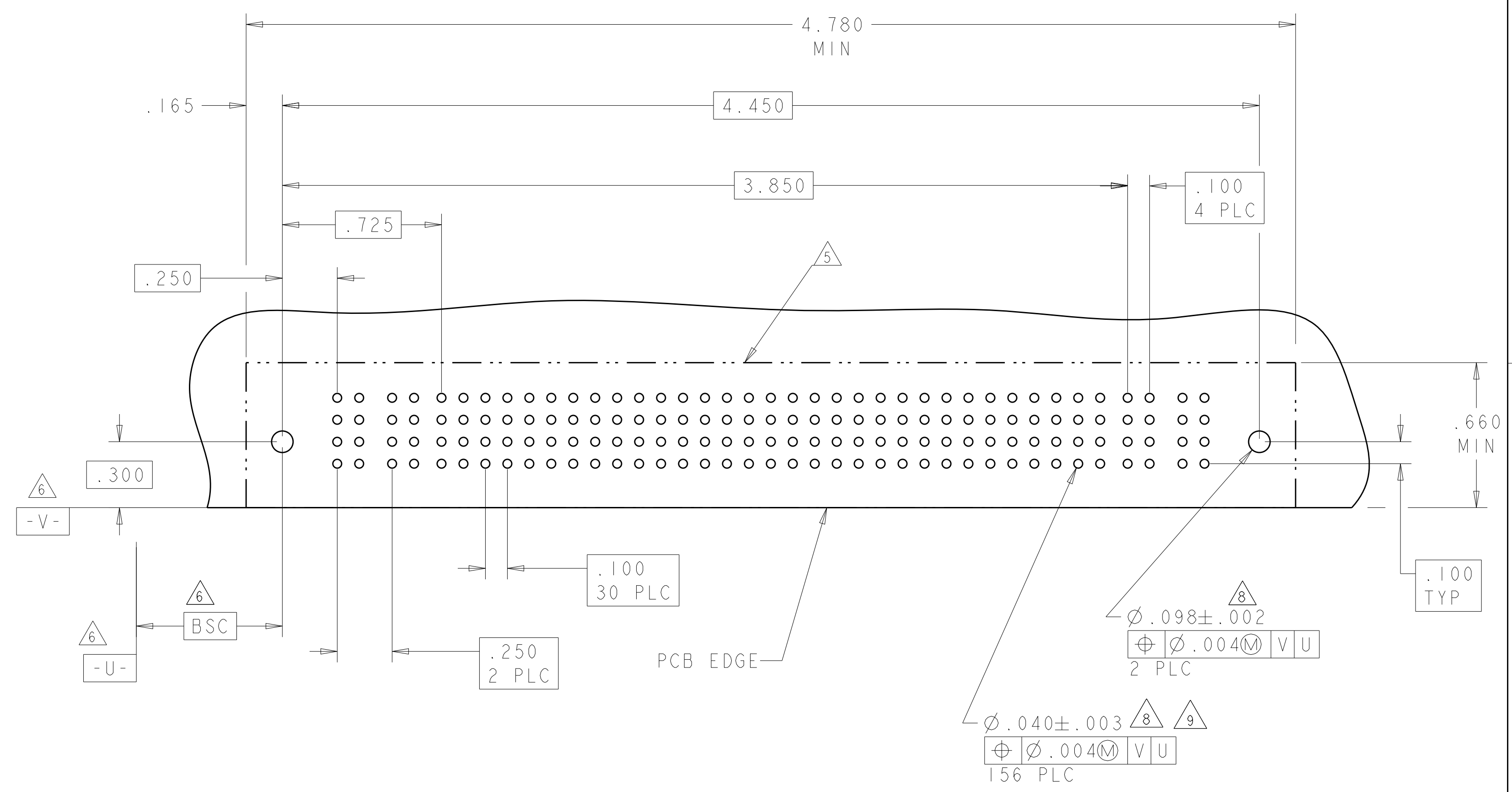
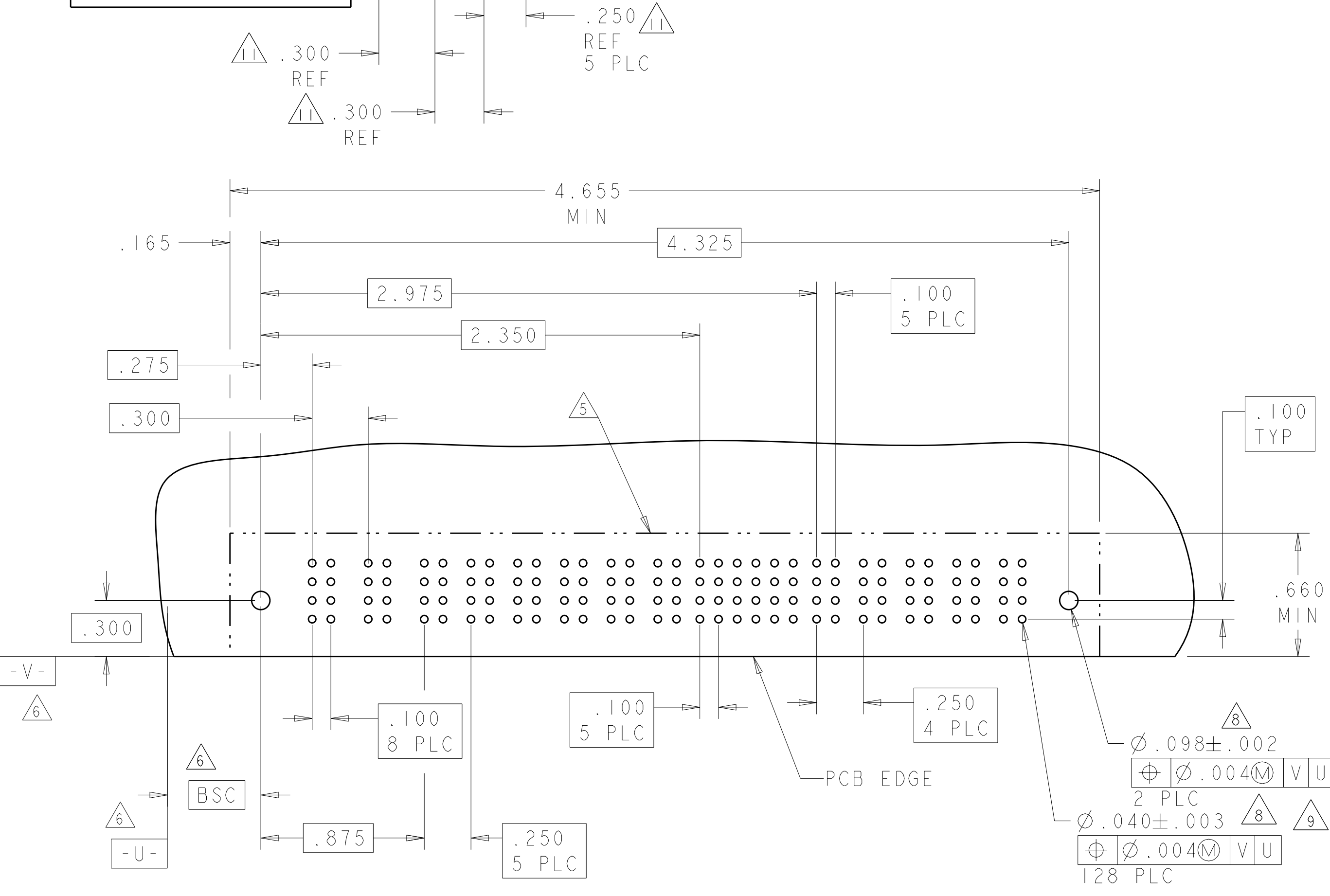

THIS DRAWING IS A CONTROLLED DOCUMENT.

OWN: R. GRZYBOWSKI 14FEB2005
 CHK: M. PERCHERKE 14FEB2005
 APVD: M. PERCHERKE 14FEB2005

DIMENSIONS: INCHES
 TOLERANCES UNLESS OTHERWISE SPECIFIED:
 0 PLC ±.
 1 PLC ±.01
 2 PLC ±.01
 3 PLC ±.005
 4 PLC ±.0020
 ANGLES ±.020

MATERIAL: -
 FINISH: -

Customer Drawing

SCALE: 4:1 SHEET 7 OF 28 REV: M2

STE TE Connectivity

RIGHT ANGLE HEADER ASSEMBLY W/GUIDES MULTI-BEAM XL

SIZE: A1 CAGE CODE: 114-13038 DRAWING NO: 108-1973

LOC	DIST	REV	DATE	BY	APPV
ES	00				

REVISIONS			
REV	DATE	BY	APPV
-	-	-	-
-	-	-	-

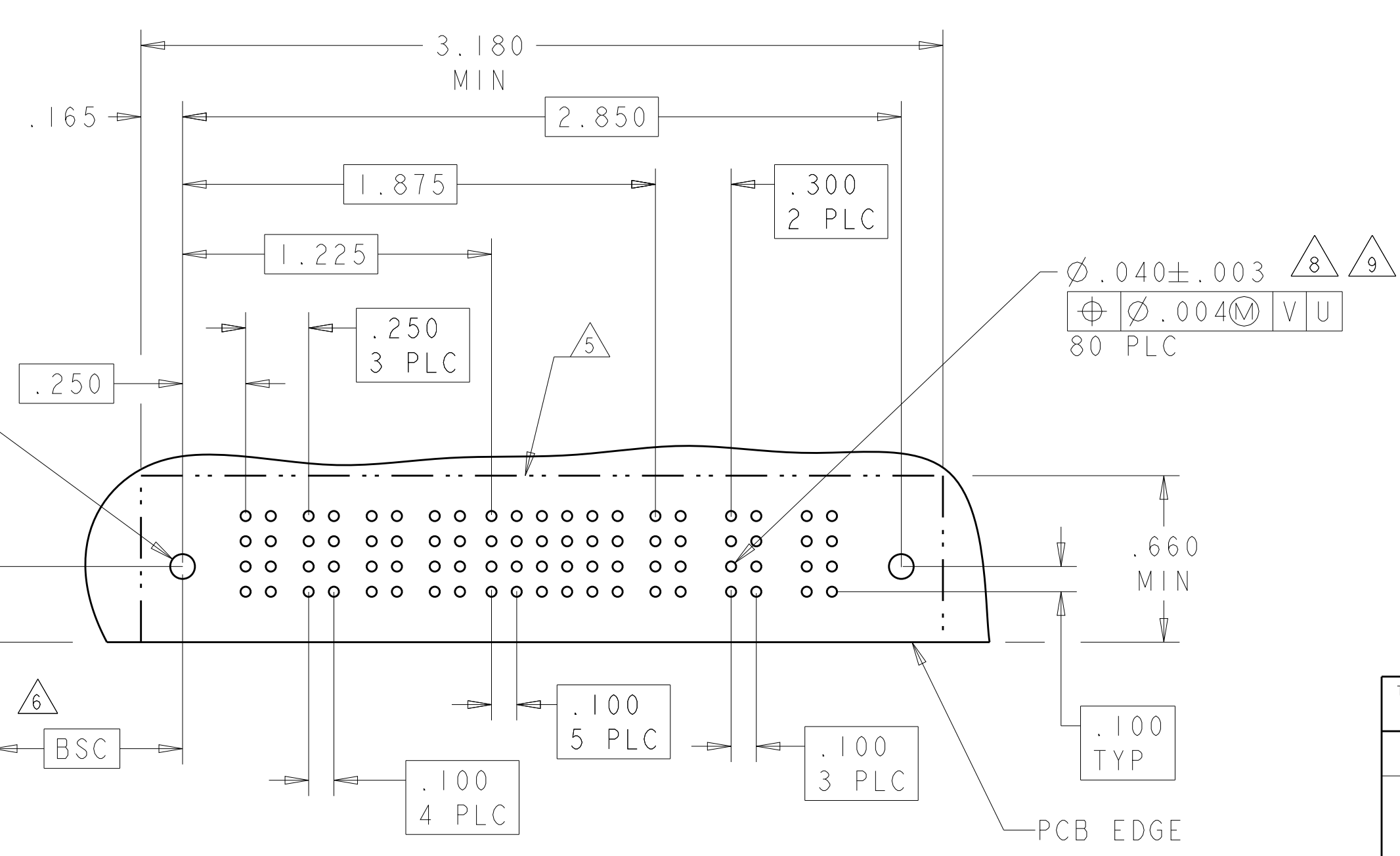
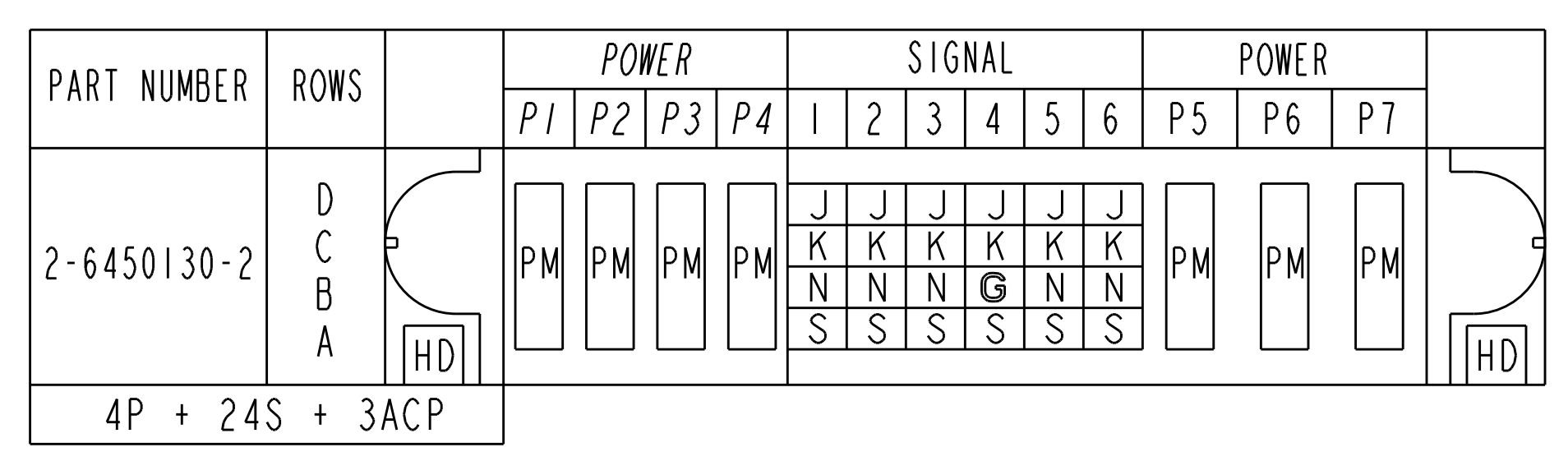
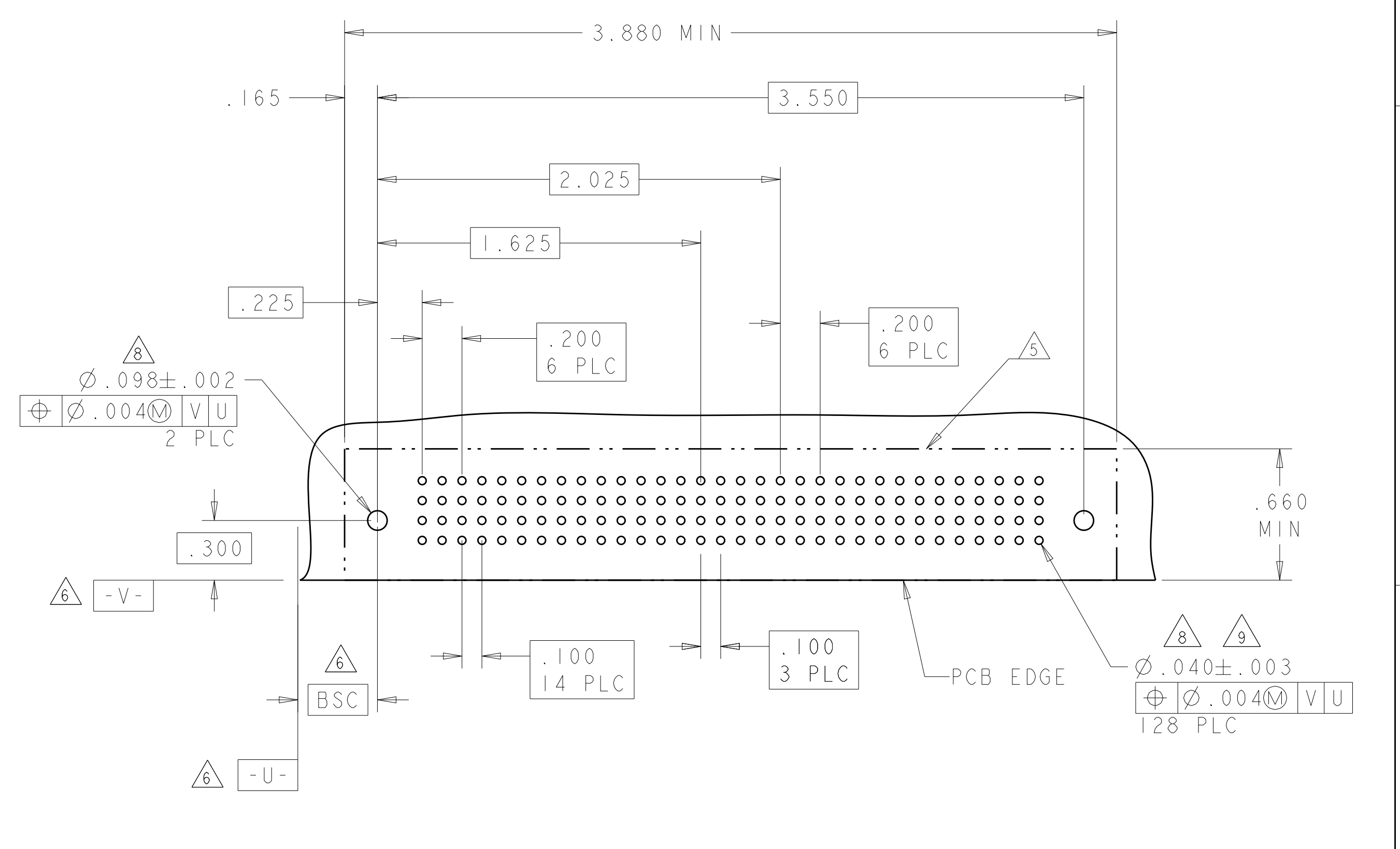
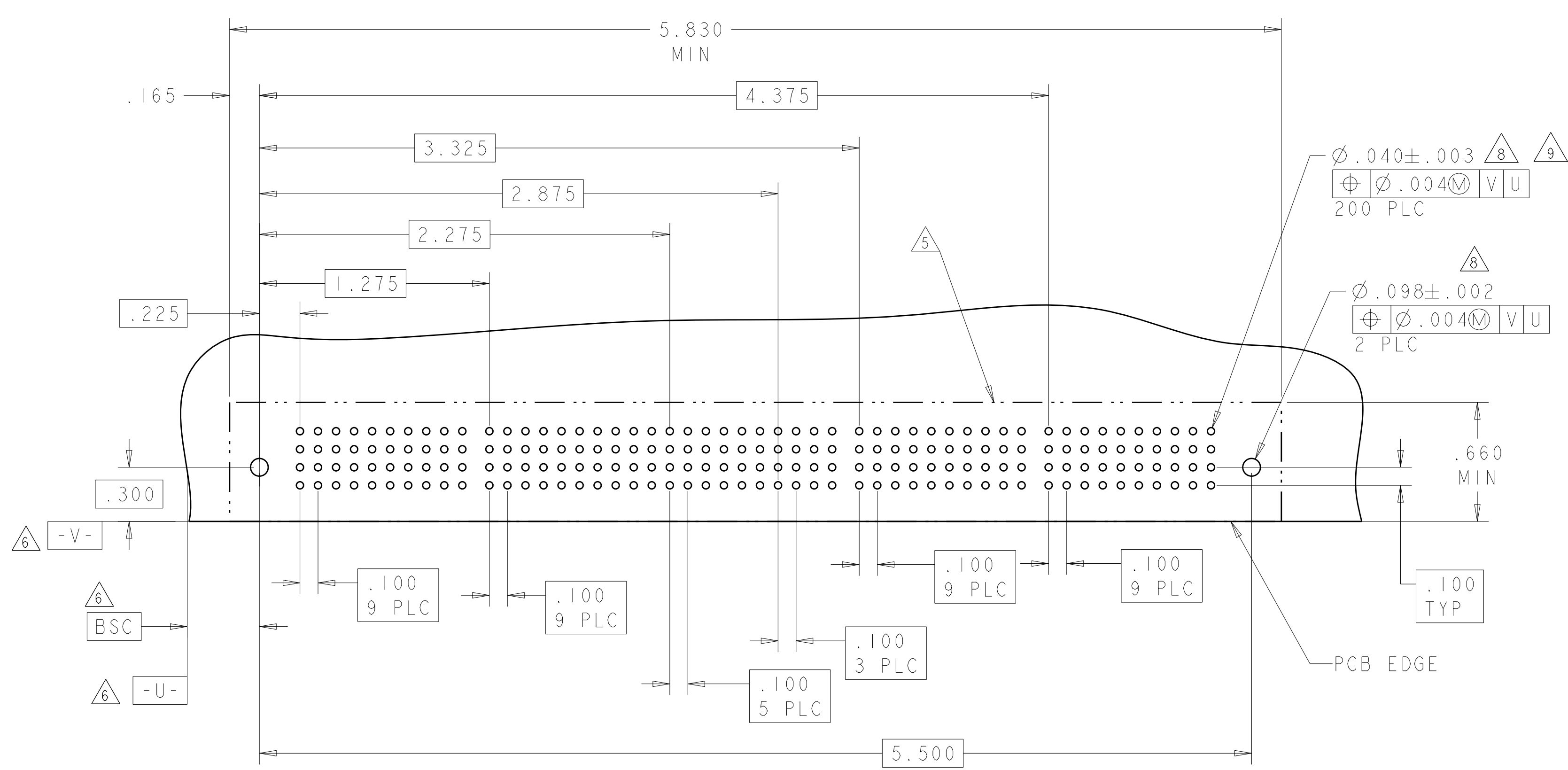
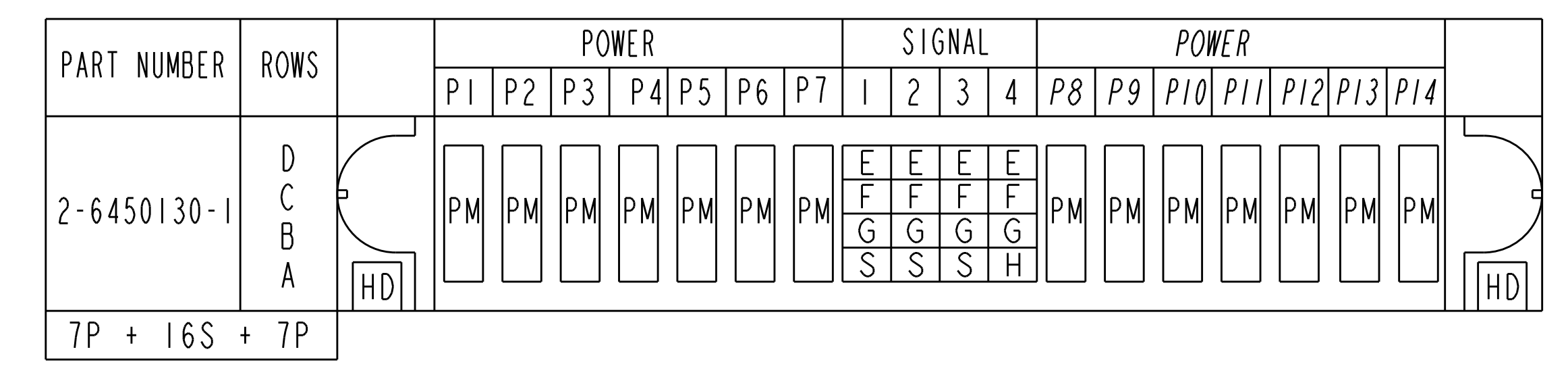
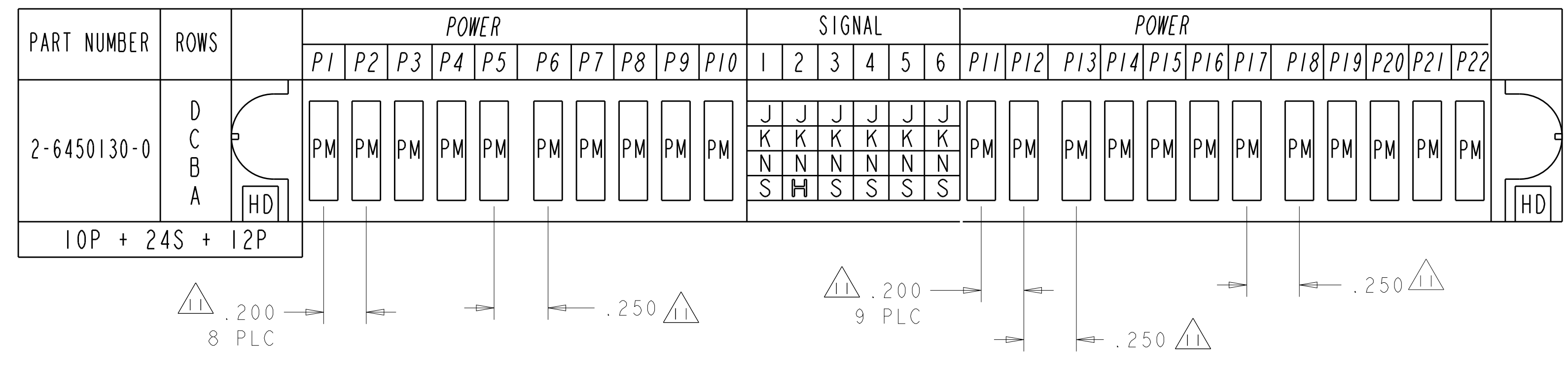

THIS DRAWING IS A CONTROLLED DOCUMENT.		OWN: R. GRZYBOWSKI 14FEB2005	TE Connectivity
DIMENSIONS: INCHES		CHK: M. PERCHERKE 14FEB2005	
TOLERANCES UNLESS OTHERWISE SPECIFIED:		APVD: M. PERCHERKE 14FEB2005	NAME: RIGHT ANGLE HEADER ASSEMBLY W/GUIDES MULTI-BEAM XL
0 PLC ±.01		PRODUCT SPEC	SIZE: CAGE CODE DRAWING NO: A100779C=6450130
1 PLC ±.01		APPLICATION SPEC	RESTRICTED TO: -
2 PLC ±.01		108-1973	SCALE: 4:1 SHEET 8 OF 28 REV: M2
3 PLC ±.005		114-13038	
4 PLC ±.002		Customer Drawing	
ANGLES: .0020			
FINISH: -			

PART NUMBER	ROWS	POWER			SIGNAL				POWER	
		P1	P2	P3	1	2	3	4	P4	P5
3-6450130-9	D C B A	PM	PM	PM	J	J	J		PM	PM
					K	K	K			
					N	N	N			
					S	S	H			

3ACP + 16S + 2P

CONTACTS NOT LOADED

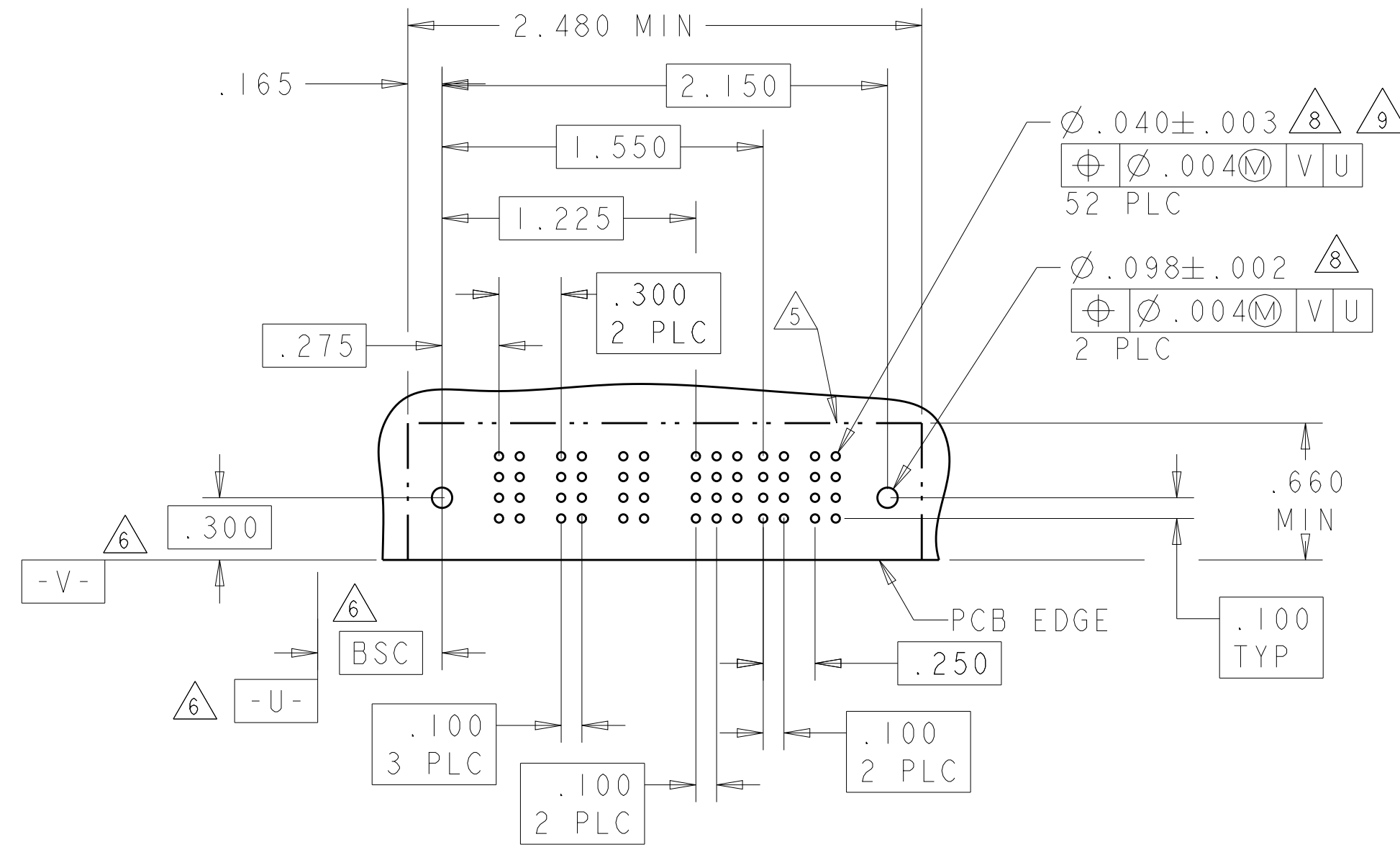

PART NUMBER	ROWS	POWER				SIGNAL				POWER			
		P1	P2	P3	P4	1	2	P5	P6	P7	P8		
4-6450130-0	D C B A	PA	PA	PA	PA	Z	Z	PA	PA	PA	PA		
						Y	Y						
						R	R						
						O	O						

4P + 8S + 4P

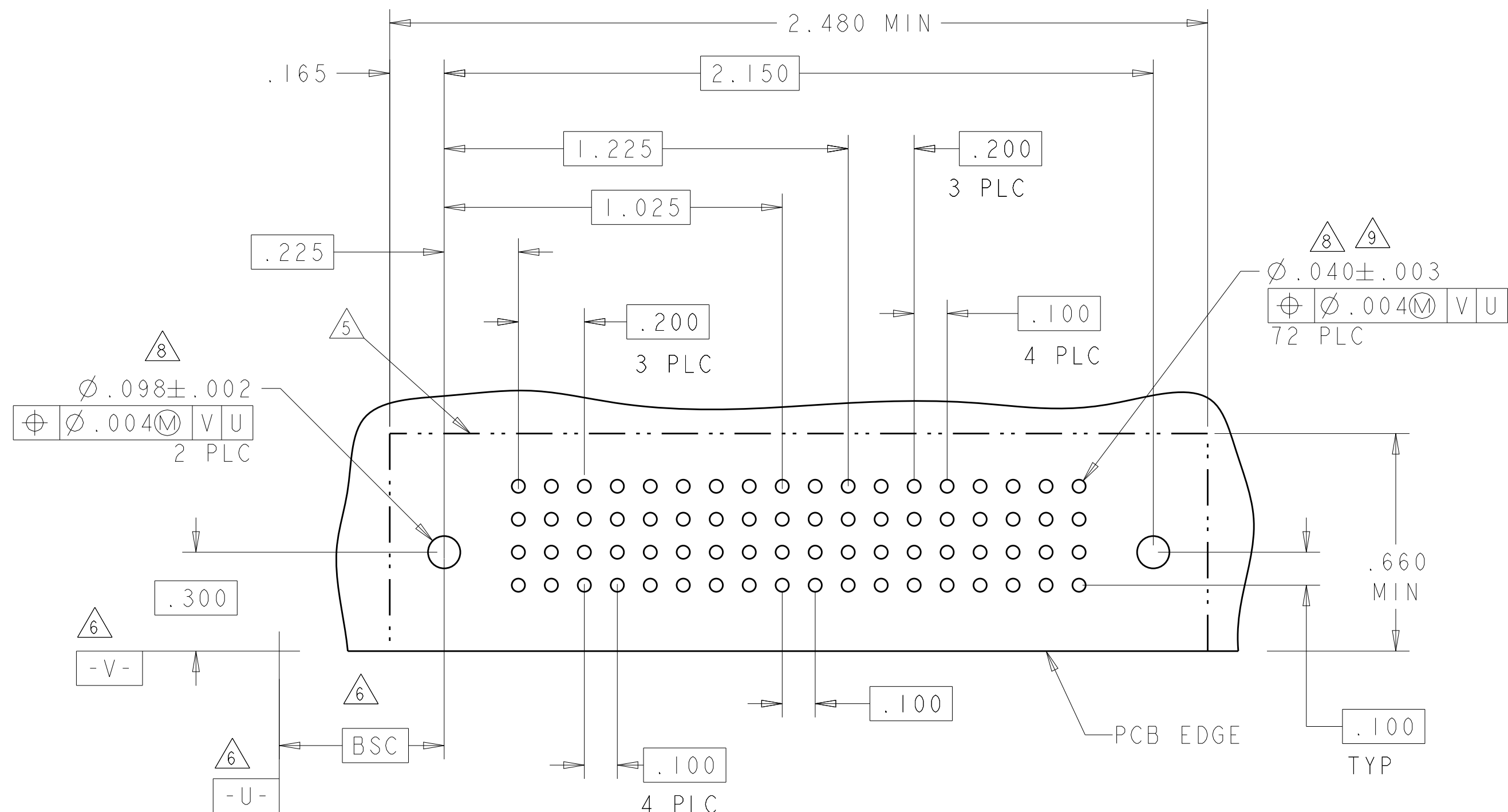

PART NUMBER	ROWS	POWER			SIGNAL				POWER	
		P1	P2	P3	1	2	3	4	P4	P5
4-6450130-3	D C B A			PM	J	J	J		PM	PM
					K	K	K			
					N	N	N			
					S	S	H			

3ACP + 16S + 2P

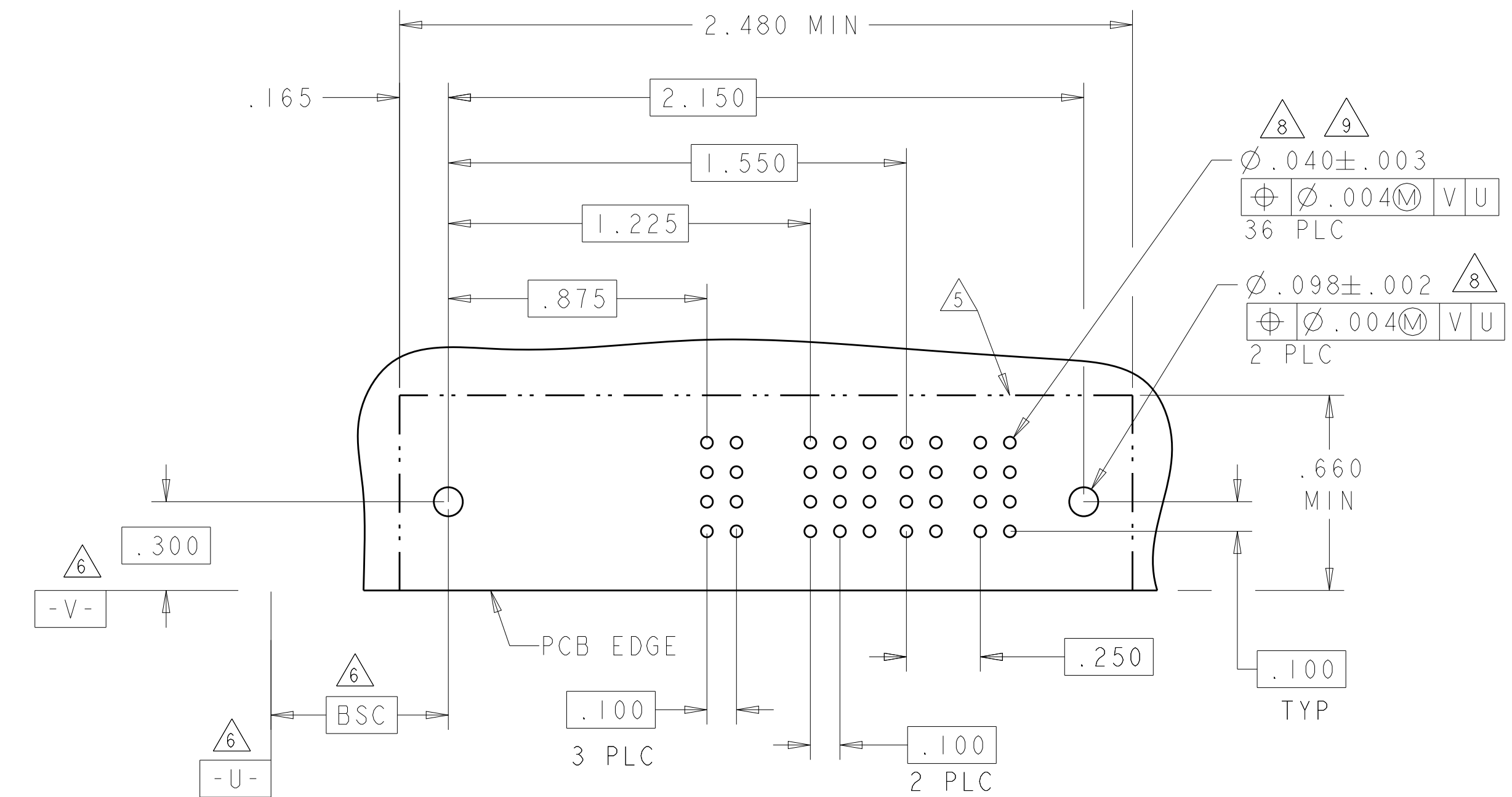

PART NUMBER	ROWS	POWER					SIGNAL								POWER				
		P1	P2	P3	P4	P5	1	2	3	4	5	6	7	8	P6	P7	P8	P9	P10
4-6450130-5	D C B A	PM	PM	PM	PM	PM	J	J	J	J	J	J	J	J	PM	PM	PM	PM	PM
							K	K	K	K	K	K	K						
							N	N	N	N	N	N	N						
							H	H	H	H	H	H	H						

5P + 32S + 5P

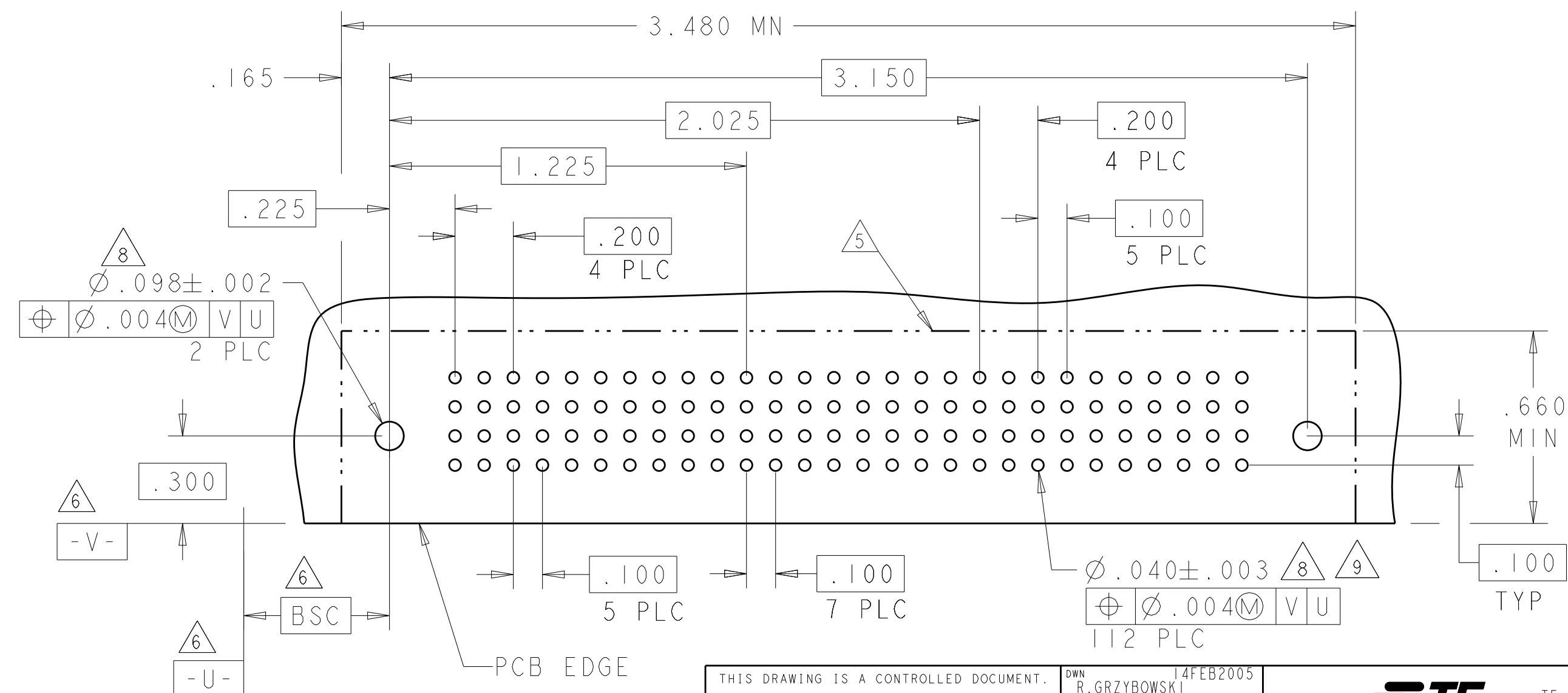

THIS DRAWING IS A CONTROLLED DOCUMENT.		OWN: R. GRZYBOWSKI 14FEB2005		TE Connectivity
DIMENSIONS: INCHES		CHK: M. PERCHERKE 14FEB2005		RIGHT ANGLE HEADER ASSEMBLY W/GUIDES MULTI-BEAM XL
TOLERANCES UNLESS OTHERWISE SPECIFIED:		APVD: M. PERCHERKE 14FEB2005	NAME: 108-1973	
0 PLC ±.01		PRODUCT SPEC	APPLICATION SPEC	
1 PLC ±.01		114-13038	SIZE: A100779C=6450130	
2 PLC ±.01		WEIGHT	SCALE: 4:1 SHEET 10 OF 28 REV: M2	
3 PLC ±.005		Customer Drawing		
4 PLC ±.002				
ANGLES ±.020				

LOC	DIST	REV	DATE	APP'D
ES	00			

PART NUMBER	ROWS	POWER				SIGNAL										POWER						
		P1	P2	P3	P4	1	2	3	4	5	6	7	8	9	10	P5	P6	P7	P8			
4-6450130-8	D C B A	PM	PM	PM	PM	J	J	J	J	J	J	J	J	J	J	J	J	J	J	J	J	
						K	K	K	K	K	K	K	K	K	K	K	K	K	K	K	K	K
						N	N	N	N	N	N	N	N	N	N	N	N	N	N	N	N	N
4P + 40S + 4P		HD		HD		HD		HD		HD		HD		HD		HD		HD				

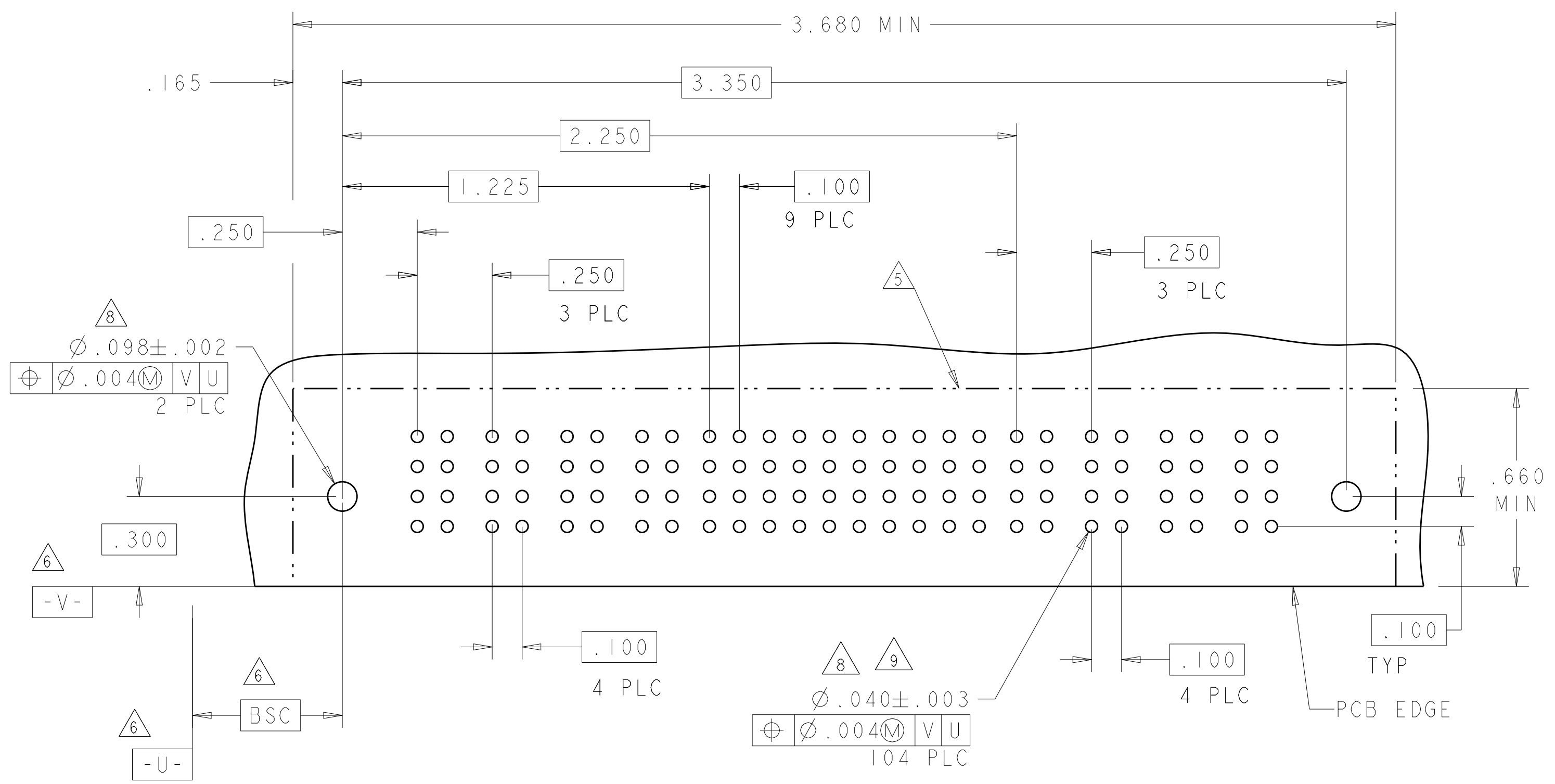

PART NUMBER	ROWS	POWER				SIGNAL										POWER					
		P1	P2	P3	P4	1	2	3	4	5	6	P5	P6	P7	P8						
4-6450130-9	D C B A	PM	PM	PM	PM	J	J	J	J	J	J	J	J	J	J	J	J	J	J	J	
						K	K	K	K	K	K	K	K	K	K	K	K	K	K	K	K
						N	N	N	N	N	N	N	N	N	N	N	N	N	N	N	N
4P + 24S + 4P		HD		HD		HD		HD		HD		HD		HD		HD		HD			

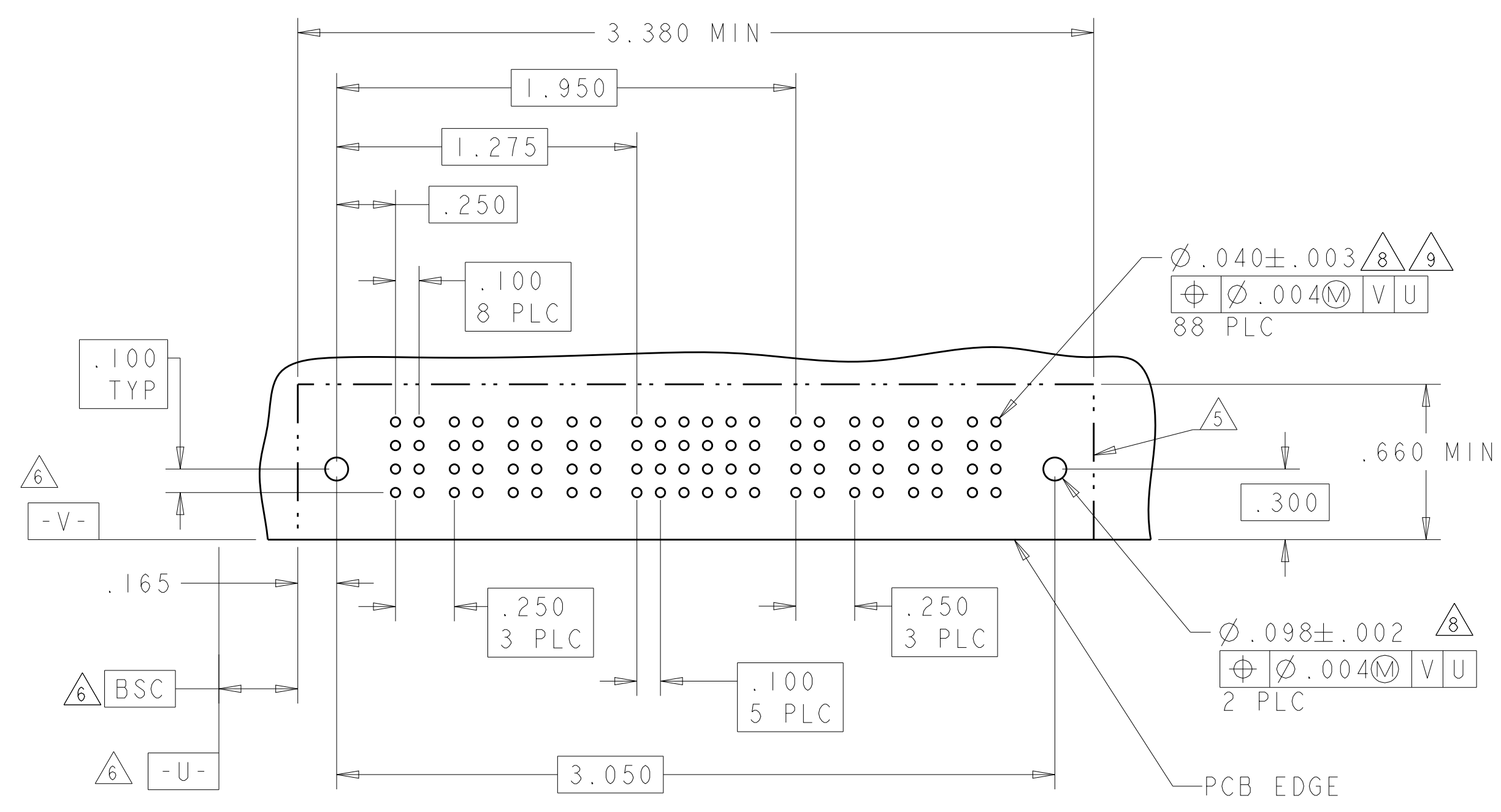

PART NUMBER	ROWS	POWER					SIGNAL										POWER					
		P1	P2	P3	P4	P5	1	2	3	4	5	6	P6	P7	P8	P9	P10					
5-6450130-0	D C B A	PM	PM	PM	PM	PM	J	J	J	J	J	J	J	J	J	J	J	J	J	J	J	
							K	K	K	K	K	K	K	K	K	K	K	K	K	K	K	K
							N	N	N	N	N	N	N	N	N	N	N	N	N	N	N	N
5ACP + 24S + 5ACP		HD		HD		HD		HD		HD		HD		HD		HD		HD				

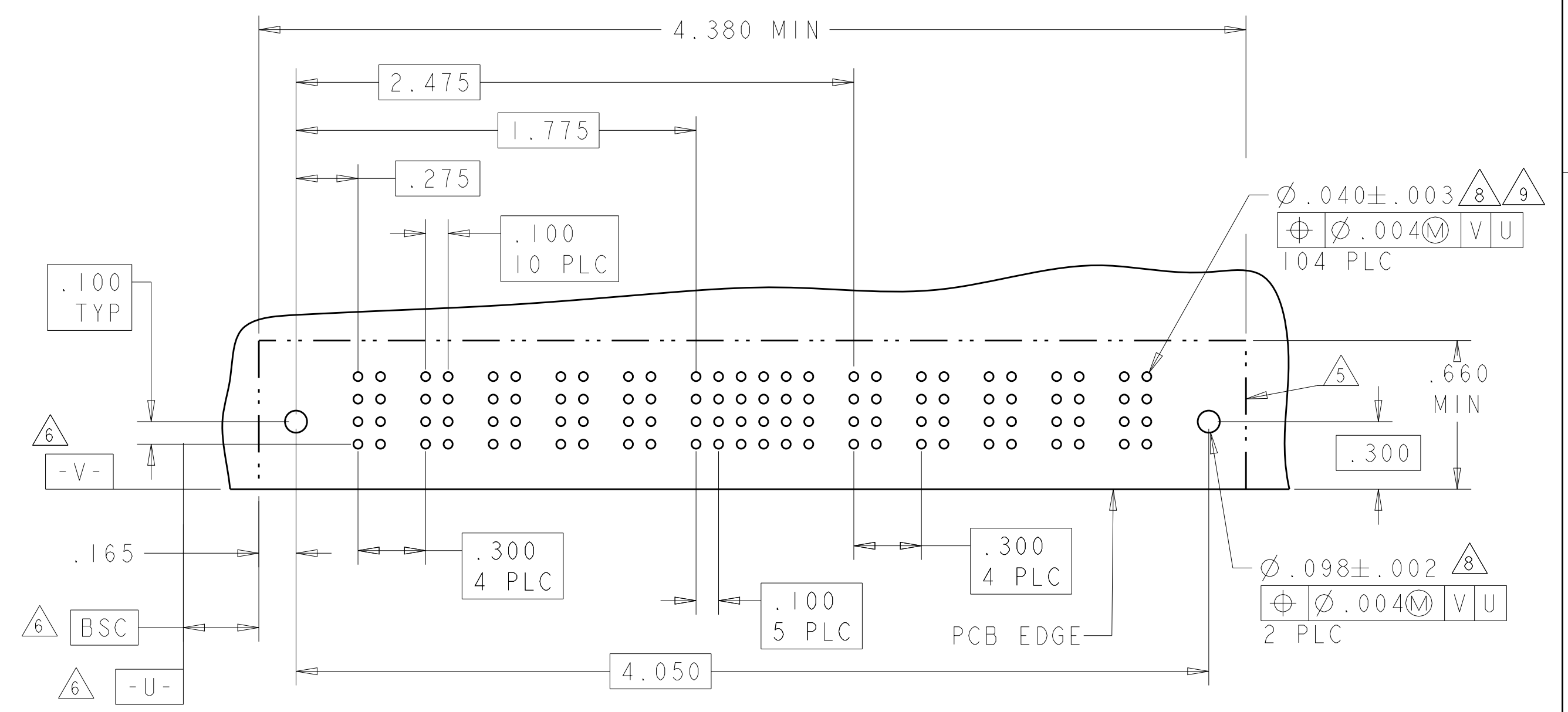

PART NUMBER	ROWS	POWER					SIGNAL										POWER						
		P1	P2	P3	P4	P5	1	2	3	4	5	6	7	8	P6	P7	P8	P9	P10				
5-6450130-5	D C B A	PM	PM	PM	PM	PM	J	J	J	J	J	J	J	J	J	J	J	J	J	J	J		
							K	K	K	K	K	K	K	K	K	K	K	K	K	K	K	K	K
							N	N	N	N	N	N	N	N	N	N	N	N	N	N	N	N	N
5P + 32S + 5P		HD		HD		HD		HD		HD		HD		HD		HD		HD					

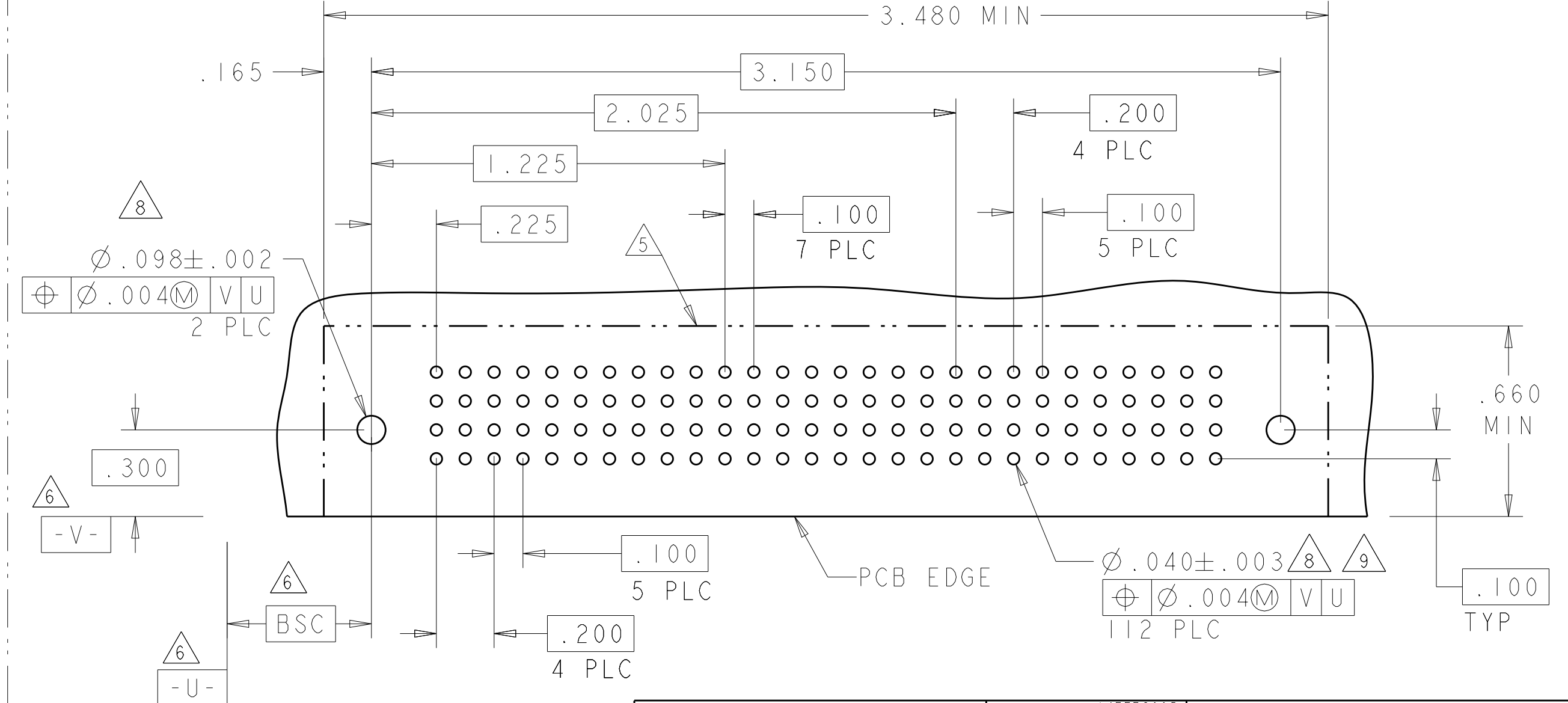

THIS DRAWING IS A CONTROLLED DOCUMENT. DWN: R.GRZYBOWSKI 14FEB2005
 CHK: M.PERCHEKKE 14FEB2005
 APVD: M.PERCHEKKE 14FEB2005

TE Connectivity

RIGHT ANGLE HEADER ASSEMBLY W/GUIDES MULTI-BEAM XL

SCALE: 4:1 SHEET 11 OF 28 REV: M2

PART NUMBER	ROWS	POWER					SIGNAL					POWER	
		P1	P2	P3	P4	P5	1	2	3	4	5	P6	P7
7-6450130-9	D C B A	PM	PM	PM	PM	PM	J	J	J	J	J	PM	PM
							K	K	K	K	K		
							N	G	N	N	N		
							S	S	S	S	S		
5P + 20S + 2P													

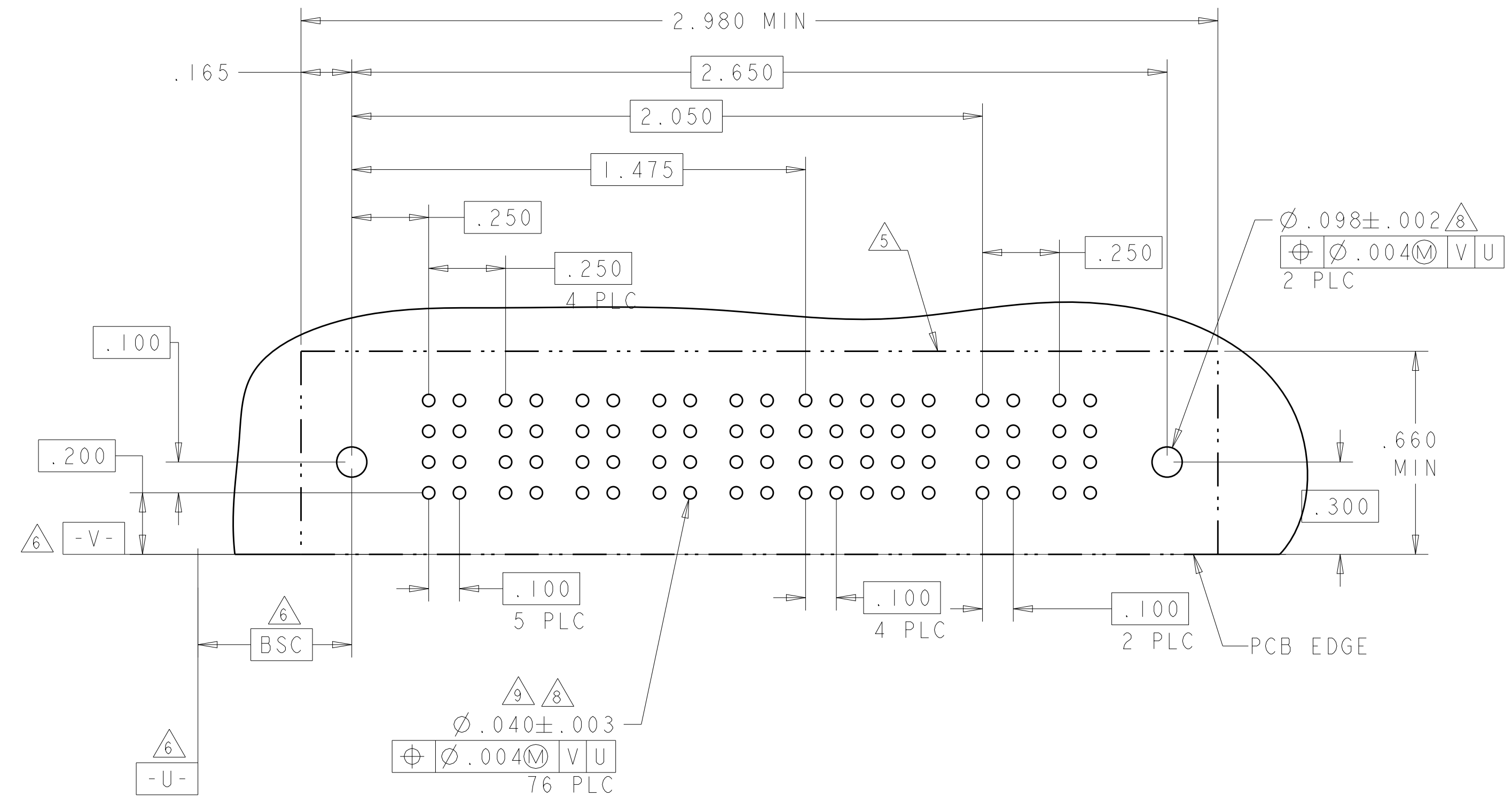

PART NUMBER	ROWS	POWER						SIGNAL					POWER	
		P1	P2	P3	P4	P5	P6	1	2	3	4	5	P7	P8
8-6450130-0	D C B A	PM	PM	PM	PM	PM	J	J	J	J	J	PM	PM	
							K	K	K	K	K			
							N	G	N	N	N			
							S	S	S	S	S			
6P + 20S + 2P														

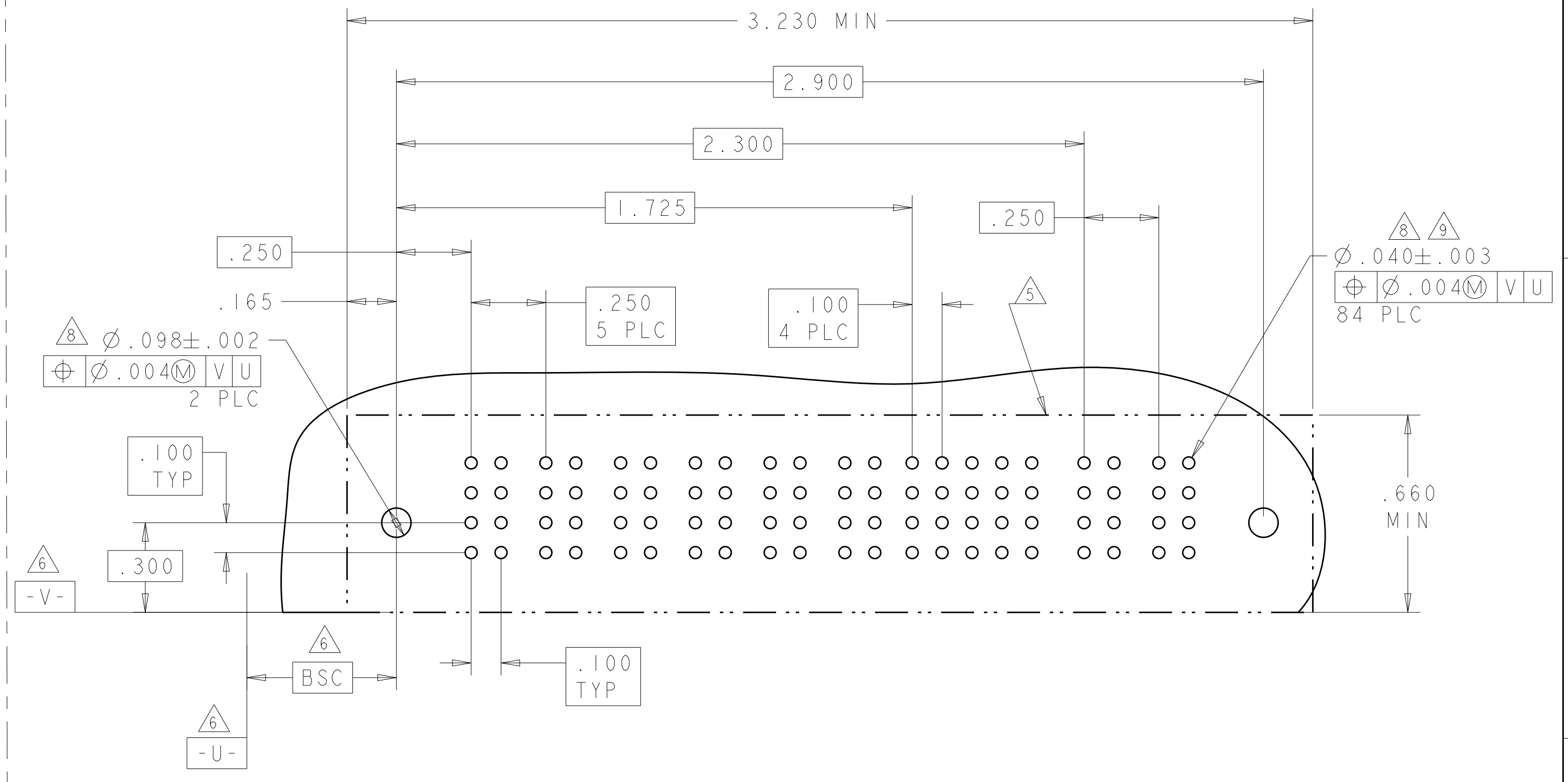

PART NUMBER	ROWS	POWER			SIGNAL						POWER				
		P1	P2	P3	1	2	3	4	5	6	P4	P5	P6	P7	P8
7-6450130-6	D C B A	PM	PM	PM							PM	PM	PM	PM	PM
					J	J	J	J	J						
					K	K	K	K	K						
					N	N	N	N	N						
3ACP + 24S + 5P		NO CONTACTS LOADER													

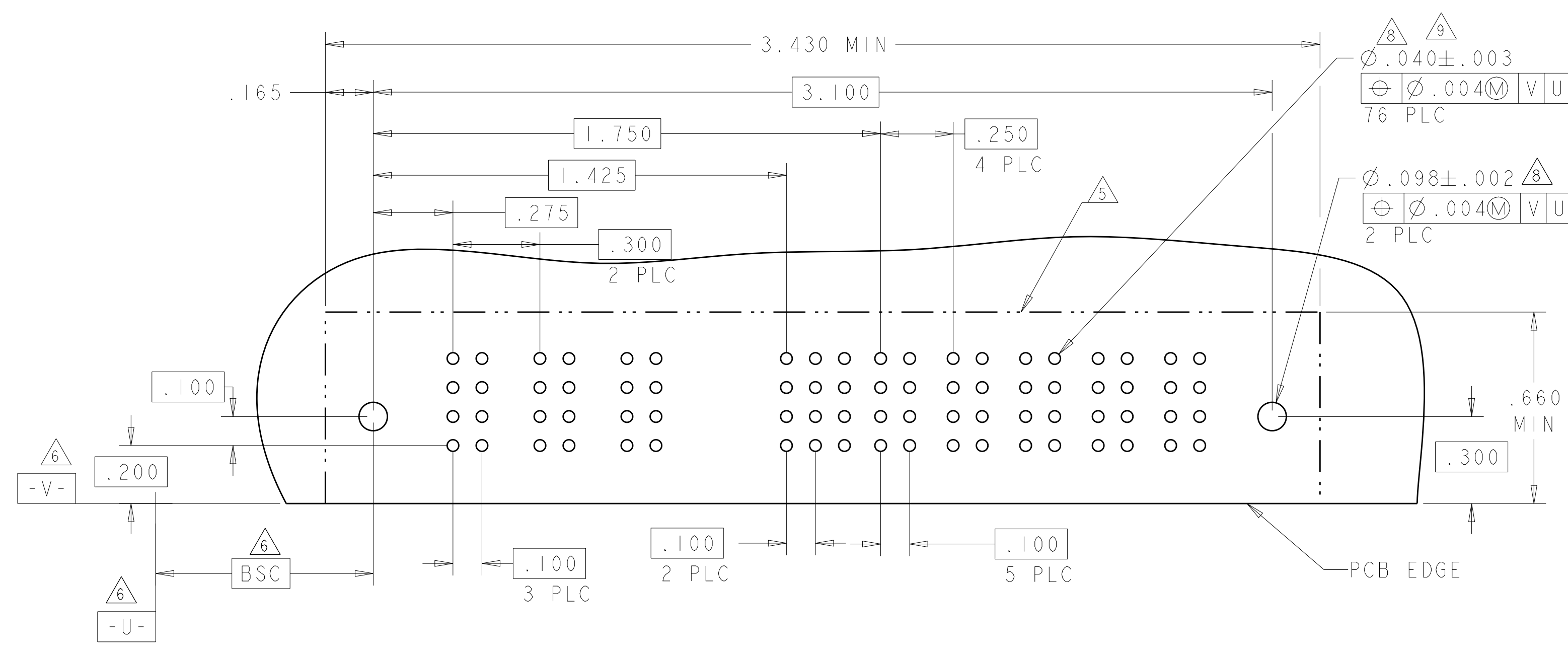

PART NUMBER	ROWS	POWER				SIGNAL						POWER		
		P1	P2	P3	P4	1	2	3	4	5	6	P5	P6	P7
8-6450130-2	D C B A	PM	PM	PM	PM	J	J	J	J	J	J	PM	PM	PM
						K	K	K	K	K	K			
						N	N	N	N	N	N			
						S	S	S	S	S	H			
4P + 24S + 3ACP														

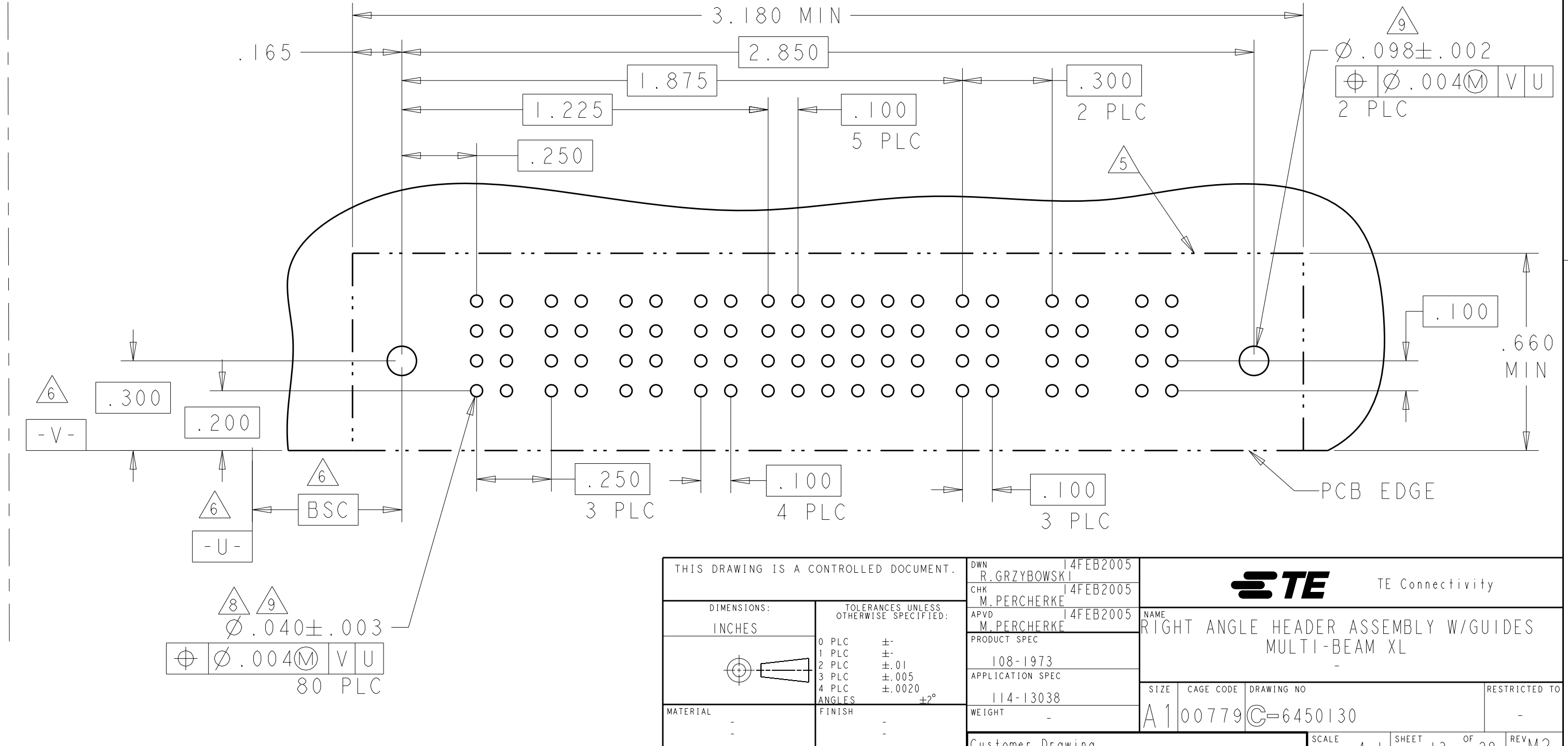

THIS DRAWING IS A CONTROLLED DOCUMENT.

<p>DIMENSIONS:</p> <p>INCHES</p>	<p>TOLERANCES UNLESS OTHERWISE SPECIFIED:</p> <p>0 PLC ± .01</p> <p>1 PLC ± .01</p> <p>2 PLC ± .01</p> <p>3 PLC ± .01</p> <p>4 PLC ± .01</p> <p>5 PLC ± .01</p> <p>ANGLES ± .002</p>	<p>OWN: R. GRZYBOWSKI 14FEB2005</p> <p>CHK: M. PERCHERKE 14FEB2005</p> <p>APPV: M. PERCHERKE 14FEB2005</p> <p>PRODUCT SPEC: 108-1973</p> <p>APPLICATION SPEC: 114-13038</p> <p>WEIGHT: A100779</p> <p>Customer Drawing</p>	<p>NAME: RIGHT ANGLE HEADER ASSEMBLY W/GUIDES MULTI-BEAM XL</p> <p>SIZE: CAGE CODE DRAWING NO: A100779</p> <p>SCALE: 4:1</p>	<p>REVISED TO: M2</p> <p>SHEET 13 OF 28</p>
----------------------------------	--	--	--	---

LOC	DIST	REV	DATE	BY	APPV
ES	00				
REVISIONS			DESCRIPTION	DATE	BY
			SEE SHEET 1		

PART NUMBER	ROWS	POWER		SIGNAL				POWER	
		P1	P2	1	2	3	4	P3	P4
8-6450130-9	D	PM	PM	J	J	J	J	PM	PM
	C			K	K	F	K		
	B			N	N	G	N		
	A			S	S	S	S		
IP + 16S + IP									

PART NUMBER	ROWS	POWER		SIGNAL						POWER	
		P1	P2	1	2	3	4	5	6	P3	P4
2-6450130-9	D	PM	PM	J	J	J	J	J	J	PM	PM
	C			K	K	K	K	F			
	B			N	N	N	N	N			
	A			S	S	S	S	S			
2P + 24S + 2P											

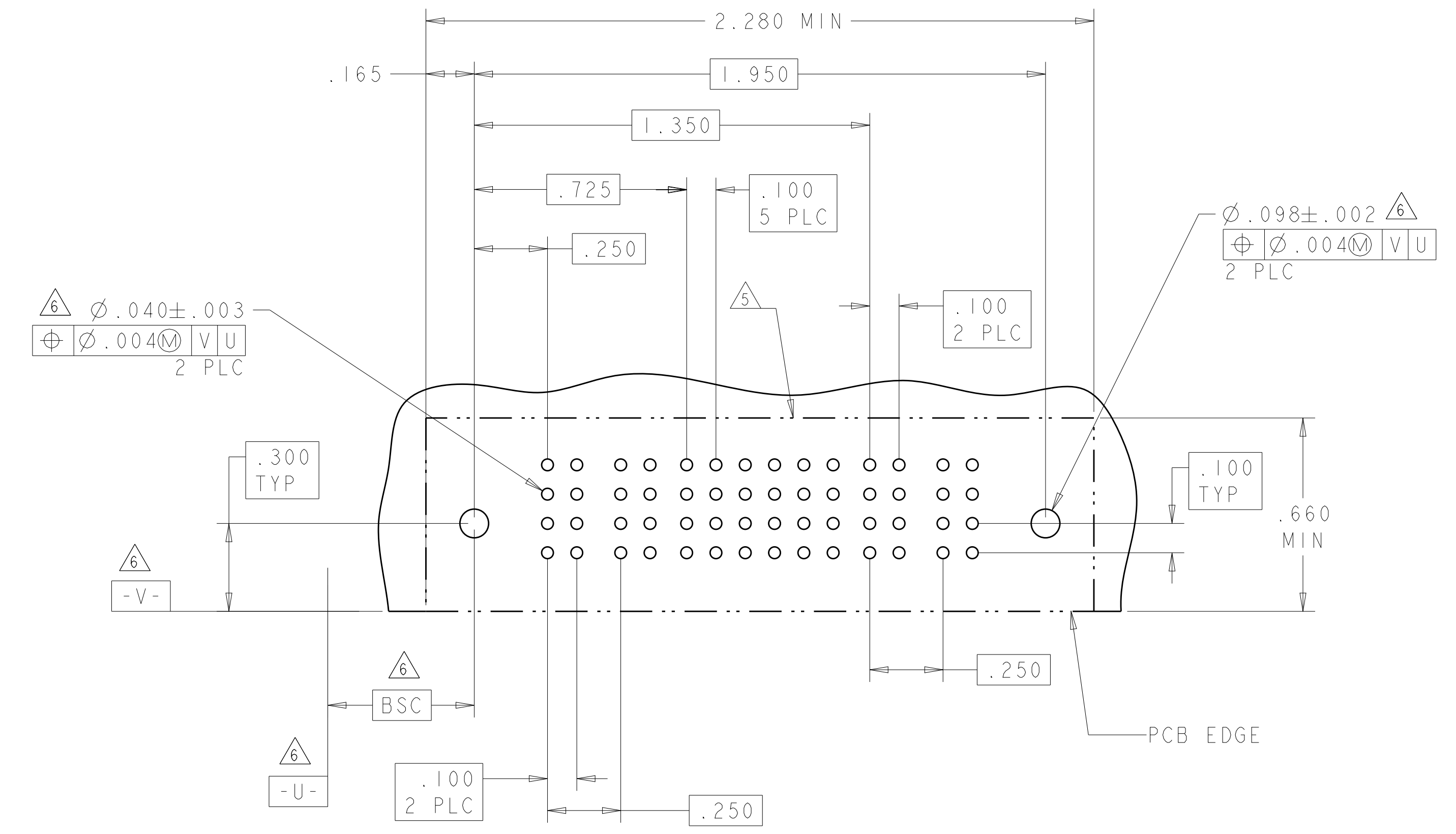
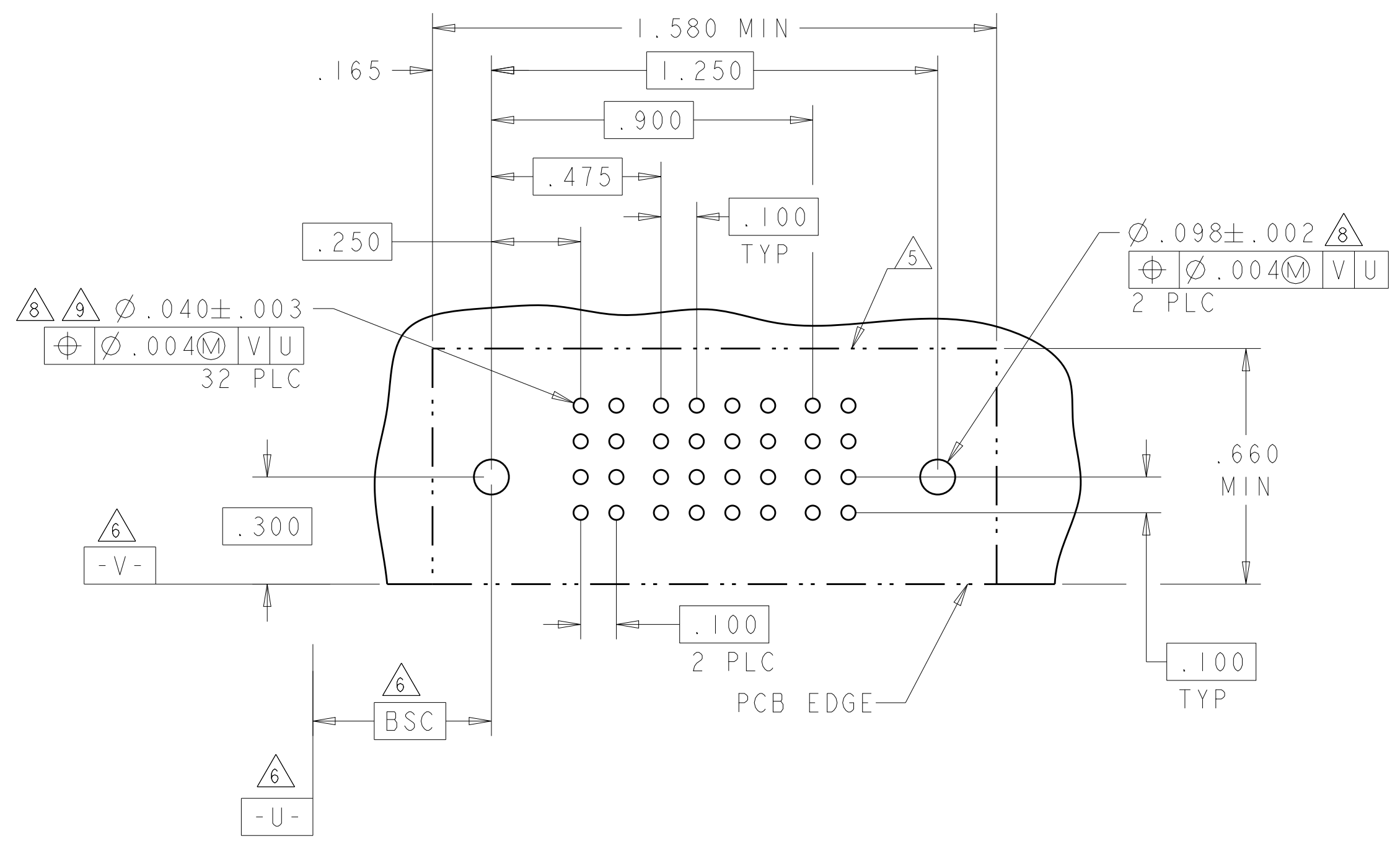

THIS DRAWING IS A CONTROLLED DOCUMENT.		OWN: R. GRZYBOWSKI 14FEB2005	 TE Connectivity
DIMENSIONS: INCHES		CHK: M. PERCHERKE 14FEB2005	
TOLERANCES UNLESS OTHERWISE SPECIFIED:		APVD: M. PERCHERKE 14FEB2005	NAME: RIGHT ANGLE HEADER ASSEMBLY W/GUIDES MULTI-BEAM XL
0 PLC ±.01	1 PLC ±.01	PRODUCT SPEC: 108-1973	SIZE: CAGE CODE DRAWING NO: A100779C=6450130
2 PLC ±.01	3 PLC ±.005	APPLICATION SPEC: 114-13038	RESTRICTED TO: -
4 PLC ±.0020	ANGLES ±.0020	WEIGHT: -	SCALE: 4:1 SHEET 16 OF 28 REV: M2
MATERIAL: -	FINISH: -	Customer Drawing	

LOC	DIST	REVISIONS			
ES	00	REV	DATE	BY	APPV
		1	SEE SHEET 1		

PART NUMBER	ROWS	POWER		SIGNAL						POWER			
		P1	P2	1	2	3	4	5	6	P3	P4		
4-6450130-2	D	PM	PM	J	J	J	J	J	E	PM	PM		
	C			K	K	K	K	K					
	B			N	N	N	N	N					
	A			S	S	S	S	S					
		HD											HD
2P + 24S + 2P													

PART NUMBER	ROWS	POWER		SIGNAL						POWER			
		P1	P2	1	2	3	4	5	6	P3	P4		
6-6450130-7	D	PM	PM	J	J	J	J	J	J	PM	PM		
	C			K	K	K	K	K					
	B			N	N	N	G	N					
	A			S	S	S	S	S					
		HD											HD
2P + 24S + 2P													

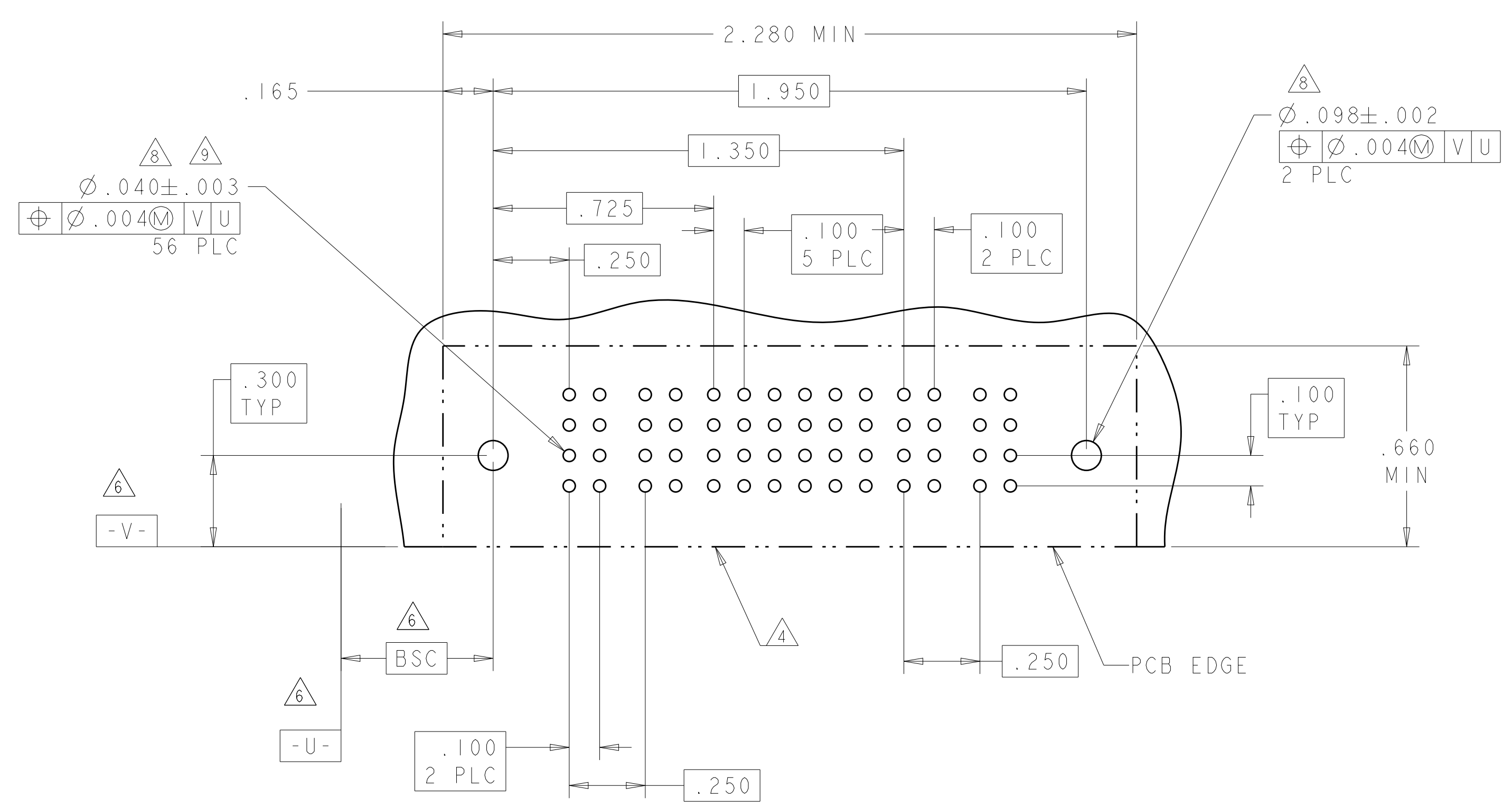
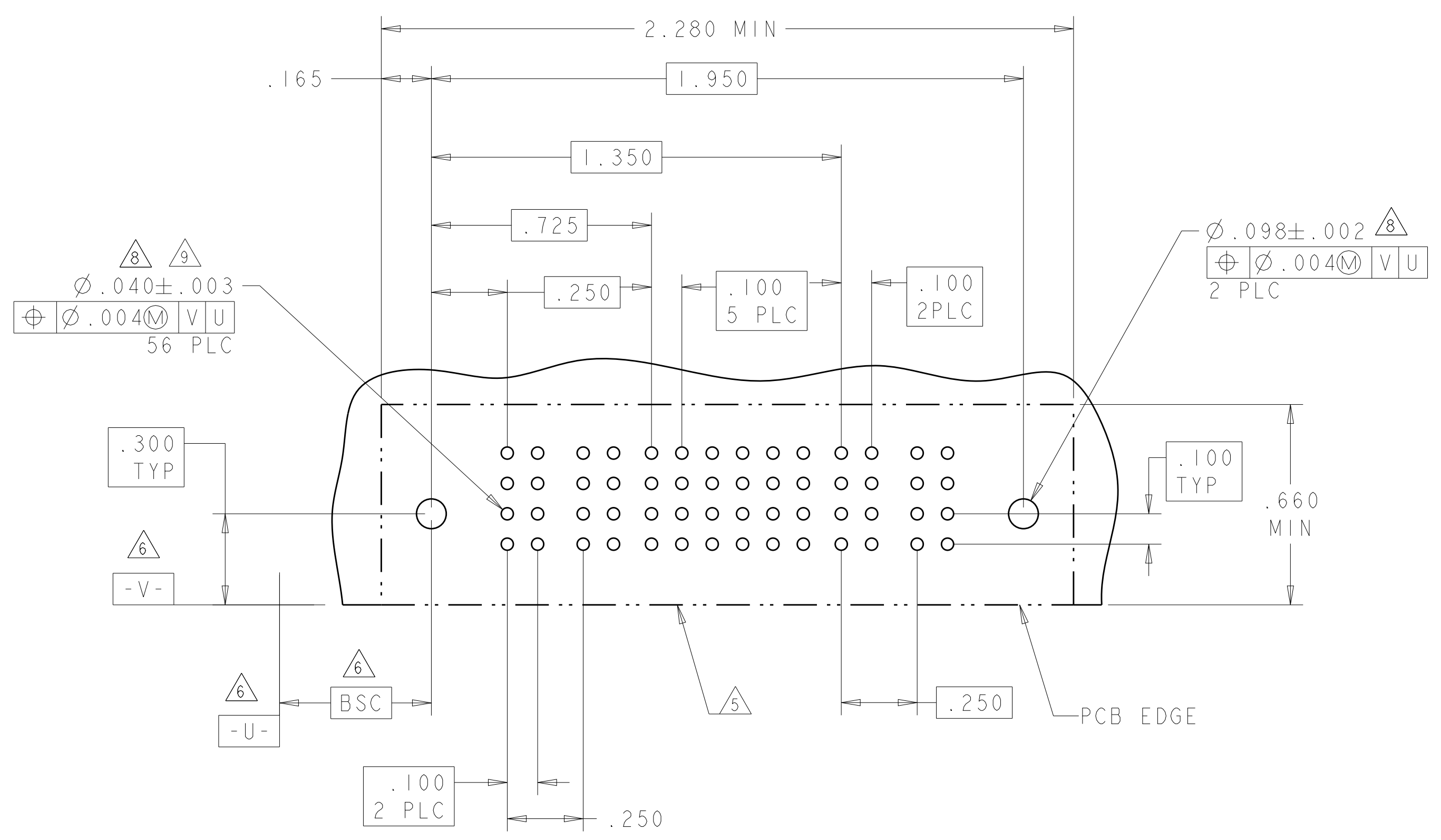

PART NUMBER	ROWS	POWER		SIGNAL						POWER			
		P1	P2	1	2	3	4	5	6	P3	P4		
8-6450130-8	D	PM	PM	E	E	E	E	E	E	PM	PM		
	C			F	F	F	F	F					
	B			G	G	G	G	G					
	A			H	H	H	H	S					
		HD											HD
2P + 24S + 2P													

LAYOUT OF PART 8-6450130-8 IS SAME AS 6-6450130-7.

THIS DRAWING IS A CONTROLLED DOCUMENT.		DWN: R. GRZYBOWSKI 14FEB2005 CHK: M. PERCZERKE 14FEB2005 APVD: M. PERCZERKE 14FEB2005	TE Connectivity	
DIMENSIONS: INCHES	TOLERANCES UNLESS OTHERWISE SPECIFIED: 0 PLC ±. 1 PLC ±.01 2 PLC ±.01 3 PLC ±.005 4 PLC ±.0020 ANGLES ±.2°	PRODUCT SPEC: 108-1973 APPLICATION SPEC: 114-13038 WEIGHT:	NAME: RIGHT ANGLE HEADER ASSEMBLY W/GUIDES MULTI-BEAM XL SIZE: CAGE CODE DRAWING NO: A100779 C=6450130 RESTRICTED TO:	
MATERIAL:	FINISH:	Customer Drawing	SCALE: 4:1	SHEET 17 OF 28 REV M2

LOC	DIST	REVISIONS			
P	LTN	DESCRIPTION	DATE	DMN	APVD
-	-	SEE SHEET 1	-	-	-

PART NUMBER	ROWS	POWER		SIGNAL			POWER					
		P1	P2	1	2	3	P3	P4	P5	P6	P7	
9-6450130-2	D	PM	PM	J	J	J	PM	PM	PM	PM	PM	HD
	C			K	K	K						
	B			N	N	N						
	A			S	S	S						
2P + 12S + 5P												

(K2)

PART NUMBER	ROWS	POWER				SIGNAL							POWER				
		P1	P2	P3	P4	1	2	3	4	5	6	7	P5	P6	P7	P8	
2-6450130-4	D	PA	PA	PA	PA	A4	A4	A4	A4	A4	A4	A4	PA	PA	PA	PA	HD
	C					A3	A3	A3	A3	A3	A3						
	B					A2	A2	A2	A2	A2	A2						
	A					A1	A1	A1	A1	A1	A1						
4HDP + 28S + 4HDP																	

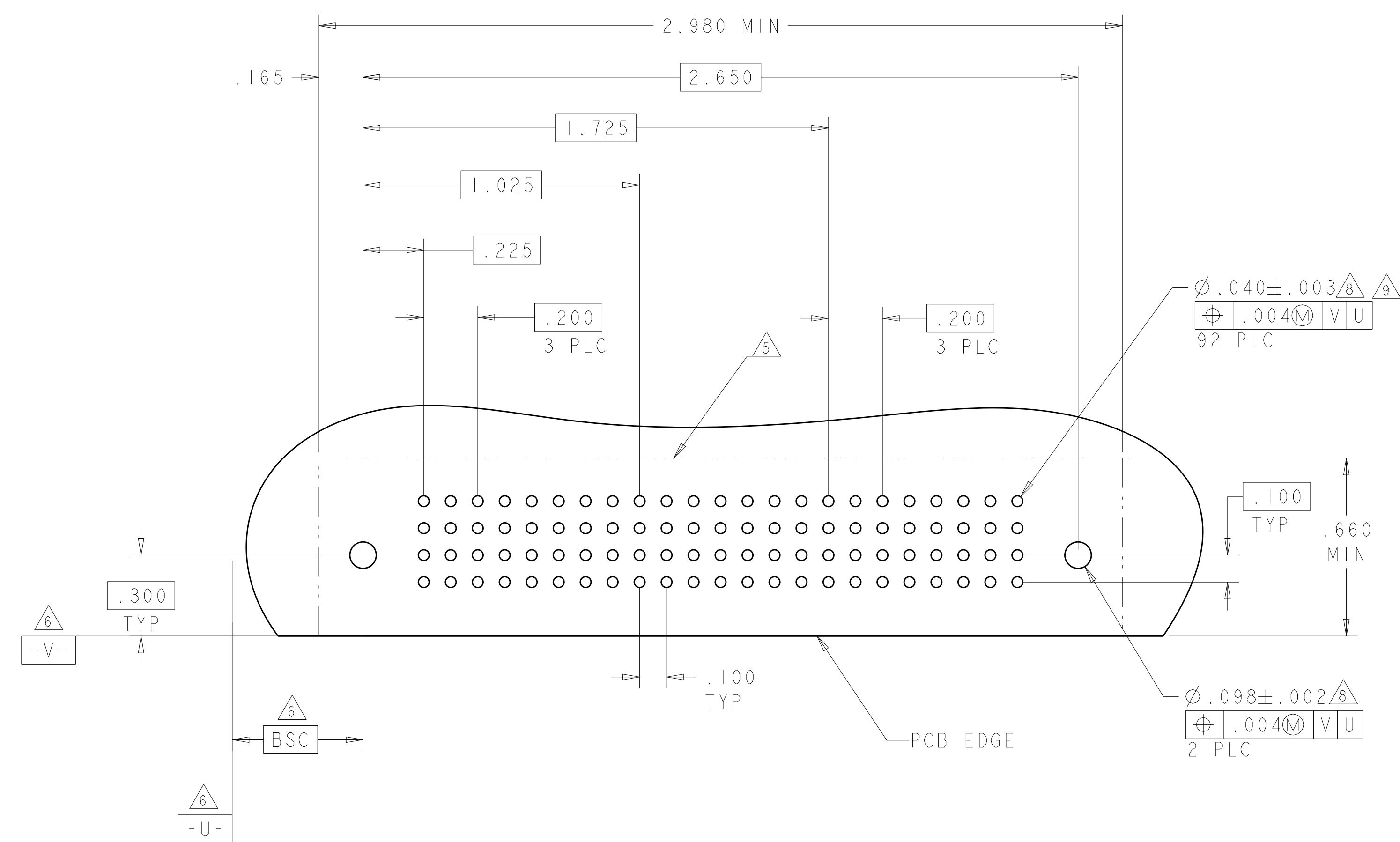
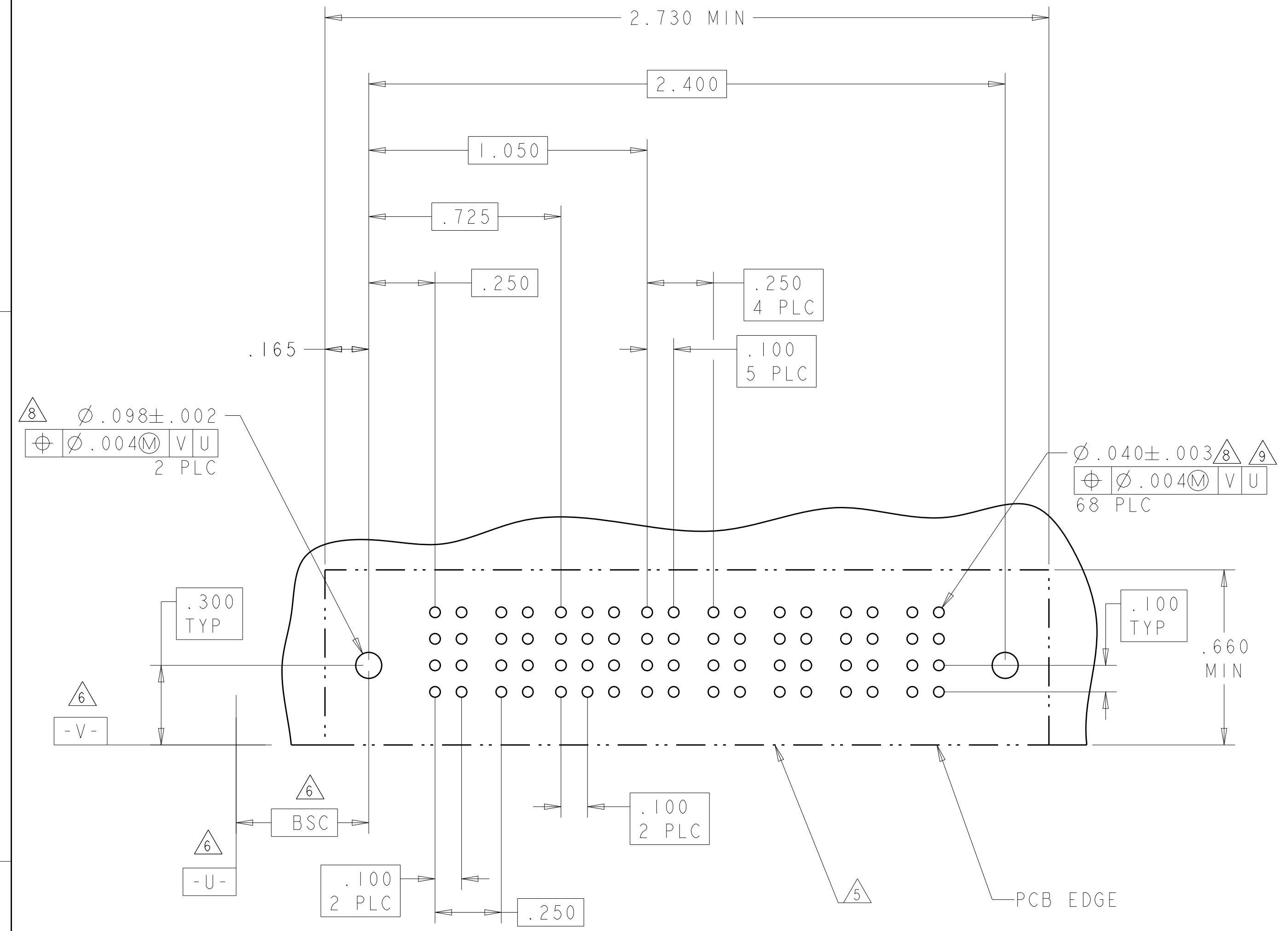

THIS DRAWING IS A CONTROLLED DOCUMENT.		DMN: R. GRZYBOWSKI 14FEB2005	TE Connectivity	
DIMENSIONS: INCHES		CHK: M. PERCHERKE 14FEB2005		
TOLERANCES UNLESS OTHERWISE SPECIFIED:		APVD: M. PERCHERKE 14FEB2005	NAME: RIGHT ANGLE HEADER ASSEMBLY W/GUIDES MULTI-BEAM XL	
0 PLC ±.01 1 PLC ±.01 2 PLC ±.01 3 PLC ±.005 4 PLC ±.0020 ANGLES ±.2°		PRODUCT SPEC: 108-1973	SIZE: CAGE CODE DRAWING NO: A100779C=6450130	
MATERIAL: -		APPLICATION SPEC: 114-13038	RESTRICTED TO: -	
FINISH: -		WEIGHT: -	SCALE: 4:1 SHEET 18 OF 28 REV: M2	
		Customer Drawing		

LOC	DIST	REVISIONS			
P	LTN	DESCRIPTION	DATE	DMN	APVD
-	-	SEE SHEET 1	-	-	-

(K5)

PART NUMBER	ROWS	POWER		SIGNAL				POWER	
		P1	P2	1	2	3	4	P3	P4
9-6450130-3	D	PM	PM	E	J	J	J	PM	PM
	C			K	K	K	K		
	B			N	N	N	N		
	A			S	S	S	S		

2P + 16S + 2P

(K6)

PART NUMBER	ROWS	POWER				SIGNAL						POWER		
		P1	P2	P3	P4	1	2	3	4	5	6	P5	P6	P7
9-6450130-4	D	PM	PM	PM	PM	J	J	J	J	J	J	PM	PM	PM
	C					K	K	K	K	K	K			
	B					N	N	N	N	N	N			
	A					S	S	S	S	S	H			

4P + 24S + 3ACP

NO CONTACT LOADED

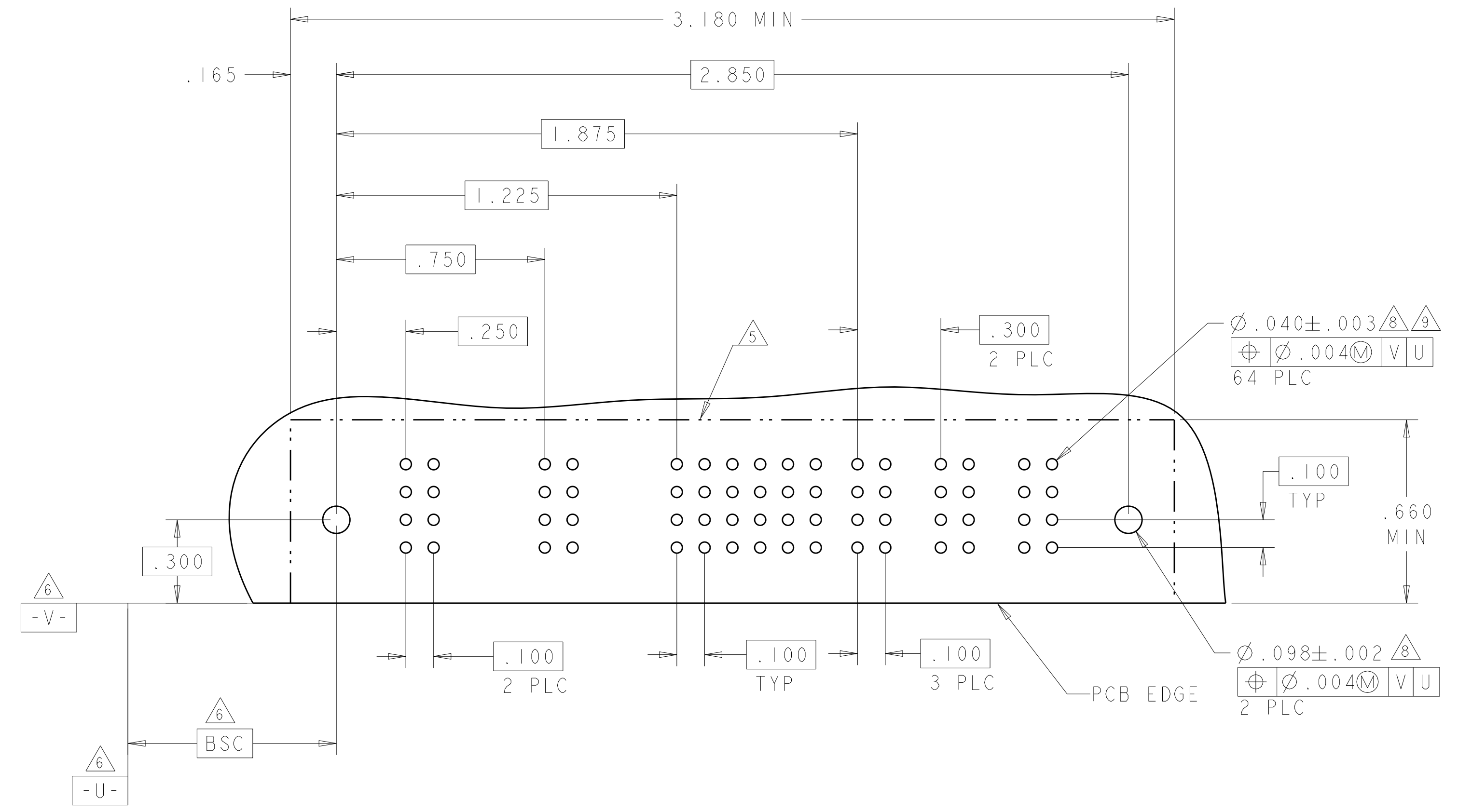
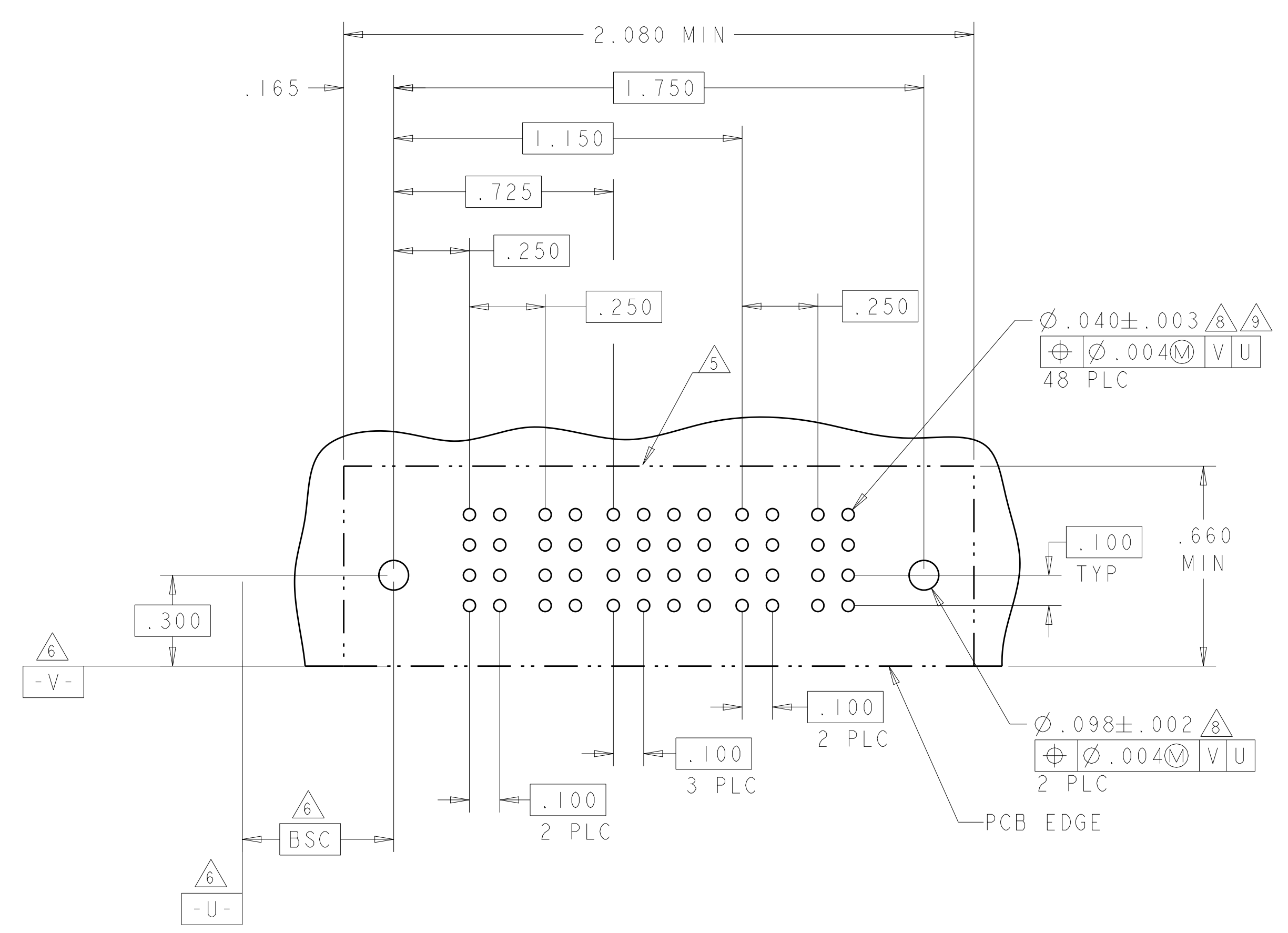

THIS DRAWING IS A CONTROLLED DOCUMENT.

DIMENSIONS:	TOLERANCES UNLESS OTHERWISE SPECIFIED:	DMN: R. GRZYBOWSKI 14FEB2005	CHK: M. PERCHERKE 14FEB2005	APVD: M. PERCHERKE 14FEB2005	NAME: RIGHT ANGLE HEADER ASSEMBLY W/GUIDES MULTI-BEAM XL
INCHES	0 PLC ±.010 1 PLC ±.008 2 PLC ±.005 3 PLC ±.003 4 PLC ±.002 ANGLES ±.020	PRODUCT SPEC: 108-1973	APPLICATION SPEC: 114-13038	WEIGHT: -	RESTRICTED TO: -
MATERIAL: -	FINISH: -	SIZE: A1	CAGE CODE: 6450130	SCALE: 4:1	SHEET 19 OF 28

Customer Drawing

LOC	DIST	REVISIONS			
P	LTN	DESCRIPTION	DATE	DMN	APVD
ES	00	SEE SHEET 1	-	-	-

PART NUMBER	ROWS	POWER		SIGNAL					POWER	
		PI	1	2	3	4	5	P2		
9-6450130-6	D	PM	HD	E	J	J			PM	HD
	C			K	K	K				
	B			N	N	N				
	A			S	S	S				

IP + 20S + IP

NO CONTACTS LOADED

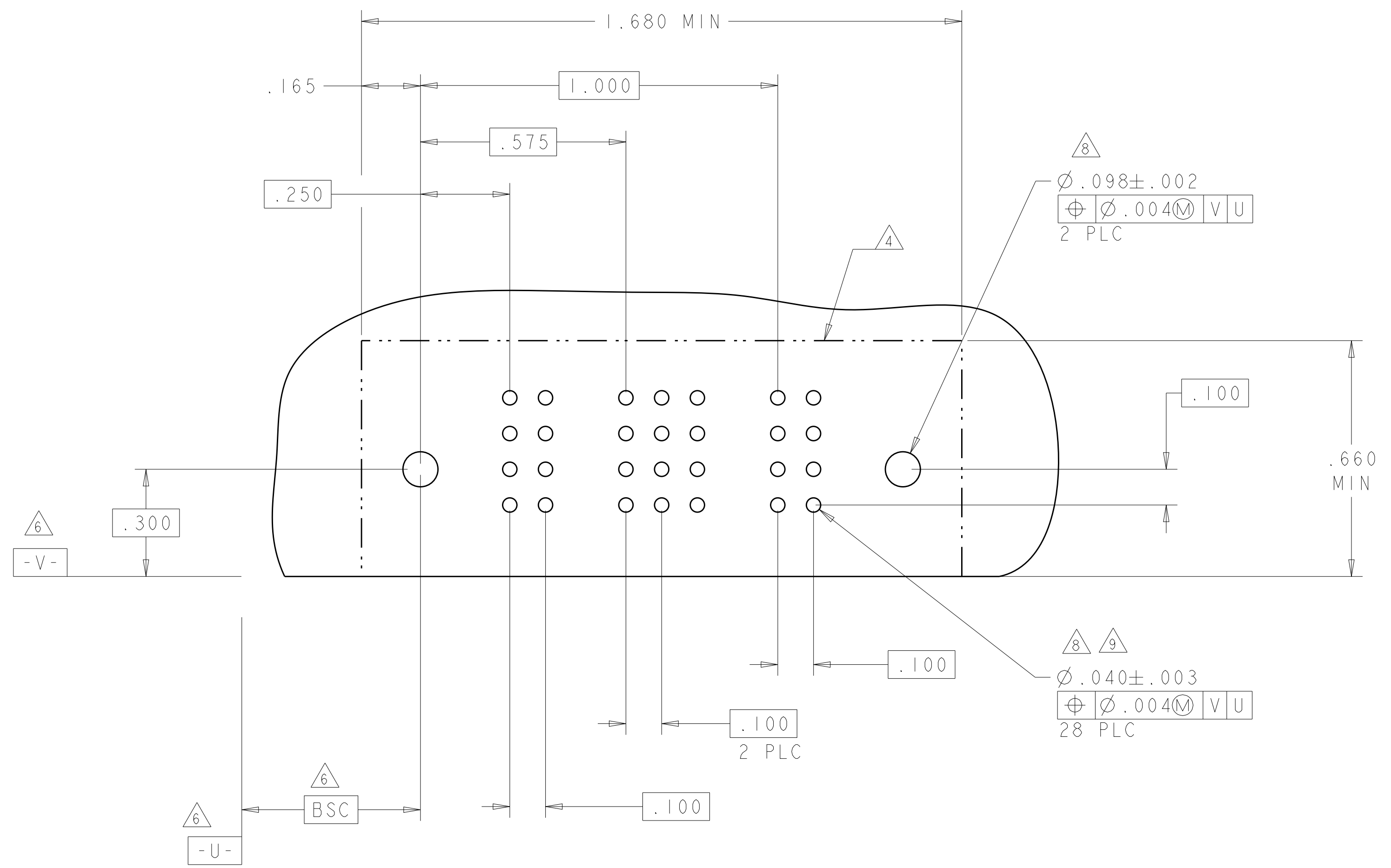

THIS DRAWING IS A CONTROLLED DOCUMENT.		DMN: R. GRZYBOWSKI 14FEB2005	 TE Connectivity
DIMENSIONS: INCHES		CHK: M. PERCHERKE 14FEB2005	
TOLERANCES UNLESS OTHERWISE SPECIFIED:		APVD: M. PERCHERKE 14FEB2005	NAME: RIGHT ANGLE HEADER ASSEMBLY W/GUIDES MULTI-BEAM XL
0 PLC ±.01	1 PLC ±.01	PRODUCT SPEC: 108-1973	SIZE: CAGE CODE DRAWING NO: A100779 C=6450130
2 PLC ±.01	3 PLC ±.005	APPLICATION SPEC: 114-13038	RESTRICTED TO: -
4 PLC ±.002	ANGLES ±.2°	WEIGHT: -	SCALE: 4:1 SHEET 23 OF 28 REV: M2
MATERIAL: -	FINISH: -	Customer Drawing	

LOC	DIST	REVISIONS			
P	LTN	DESCRIPTION	DATE	DMN	APVD
ES	00	SEE SHEET 1			

PART NUMBER	ROWS	POWER		SIGNAL												POWER		
		P1	P2	1	2	3	4	5	6	7	8	9	10	11	12	P3	P4	
6-6450130-9	D	PM	PM	E	J	J	J	J	J	J	J	J	J	J	J	E	PM	PM
	C			K	K	K	K	K	K	K	K	K	K	K	K			
	B			N	N	N	N	N	N	N	N	N	N	N	N	N		
	A			H	S	S	S	S	S	S	S	S	S	S	S	H		
2P + 48S + 2P		HD														HD		

PART NUMBER	ROWS	POWER			SIGNAL						POWER					
		P1	P2	P3	1	2	3	4	5	6	P4	P5	P6			
9-6450130-7	D	PM	PM	PM				E	E							
	C							F	F							
	B							G	G							
	A							H	H							
3P + 24S + 3P		HD								HD						

(L5)

NO CONTACT LOADED

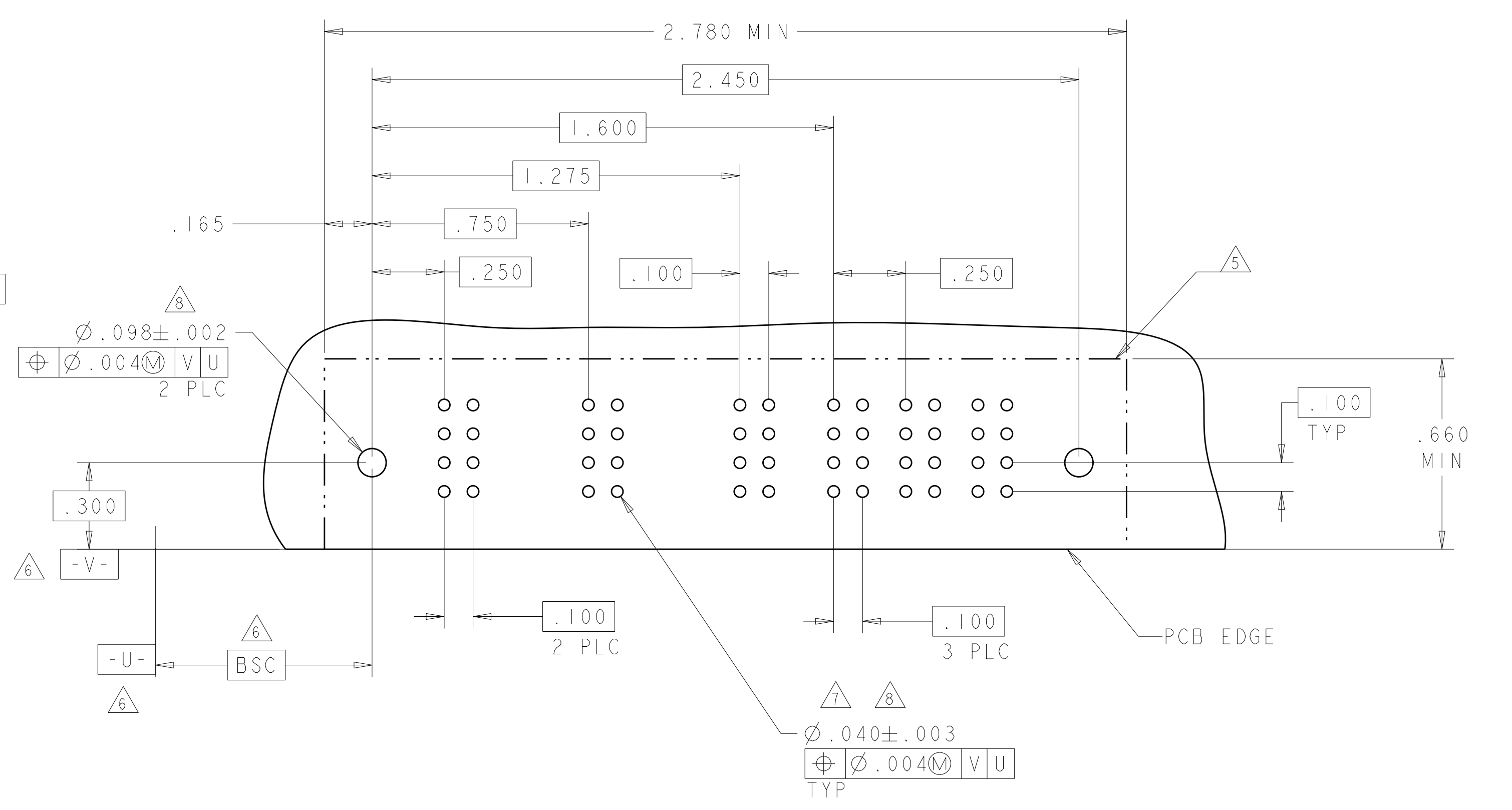
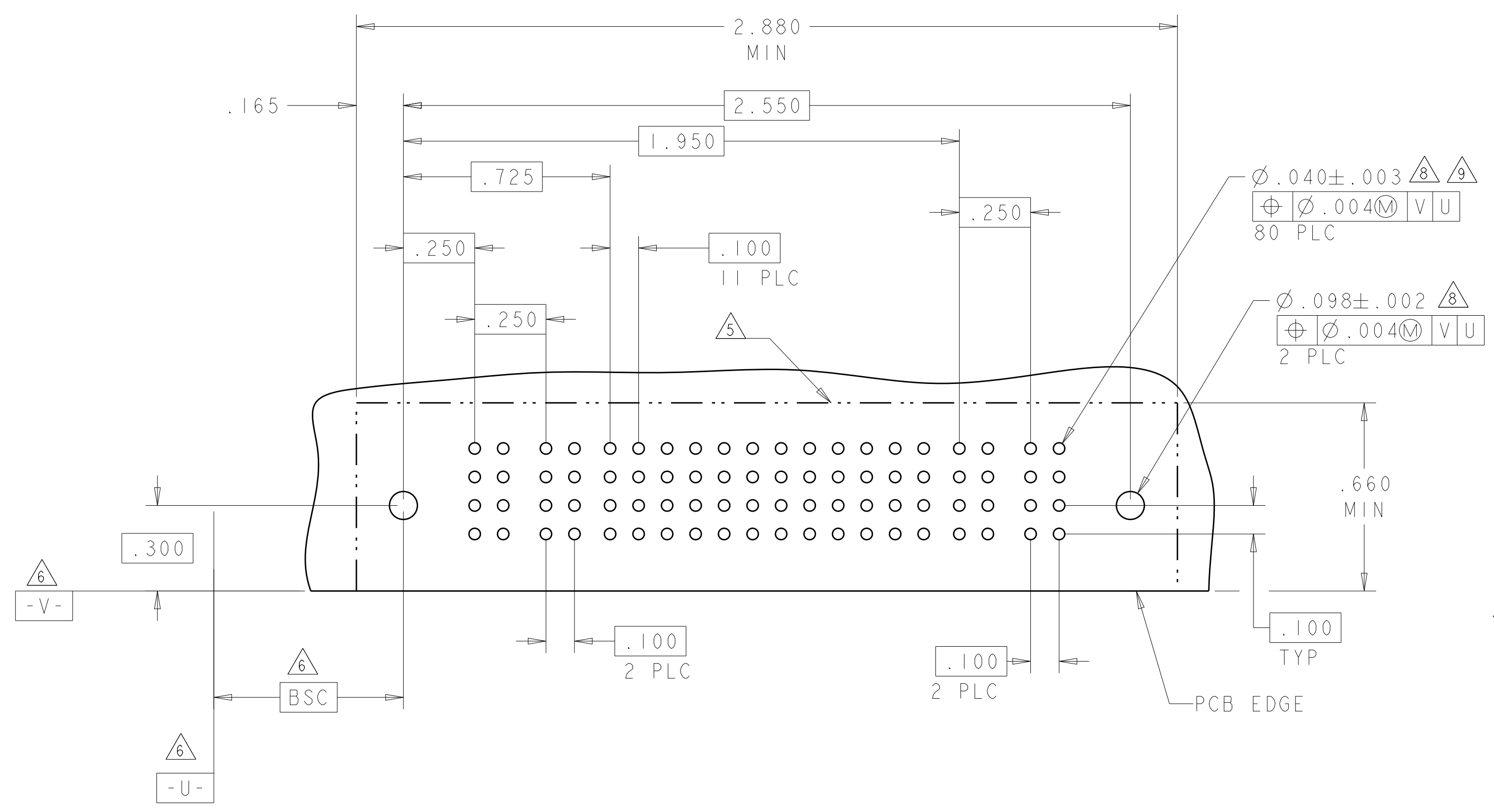

THIS DRAWING IS A CONTROLLED DOCUMENT.

DIMENSIONS:	TOLERANCES UNLESS OTHERWISE SPECIFIED:	DMN: R. GRZYBOWSKI 14FEB2005	CHK: M. PERCHERKE 14FEB2005	APVD: M. PERCHERKE 14FEB2005
INCHES	0 PLC ±.01 1 PLC ±.01 2 PLC ±.01 3 PLC ±.005 4 PLC ±.002 ANGLES ±.020	PRODUCT SPEC: 108-1973	APPLICATION SPEC: 114-13038	WEIGHT: -
MATERIAL: -	FINISH: -	SIZE: A100779	CAGE CODE: C=6450130	RESTRICTED TO: -
		Customer Drawing		SCALE: 4:1 SHEET 24 OF 28 REV: M2

STE TE Connectivity

RIGHT ANGLE HEADER ASSEMBLY W/GUIDES MULTI-BEAM XL

LOC	DIST	REVISIONS					
		P	LTH	DESCRIPTION	DATE	DWN	APVD
ES	00	-	-	SEE SHEET 1	-	-	-

PART NUMBER	ROWS	POWER		SIGNAL						POWER			
		P1	P2	1	2	3	4	5	6	P3	P4	P5	P6
9-6450130-8	D	PM	PM	E	J	J	J	J	E	PM	PM	PM	PM
	C			F	K	K	K	K	F				
	B			N	N	N	N	N	N				
	A			S	S	S	S	S	S				
2P + 24S + 4P		HD								HD			

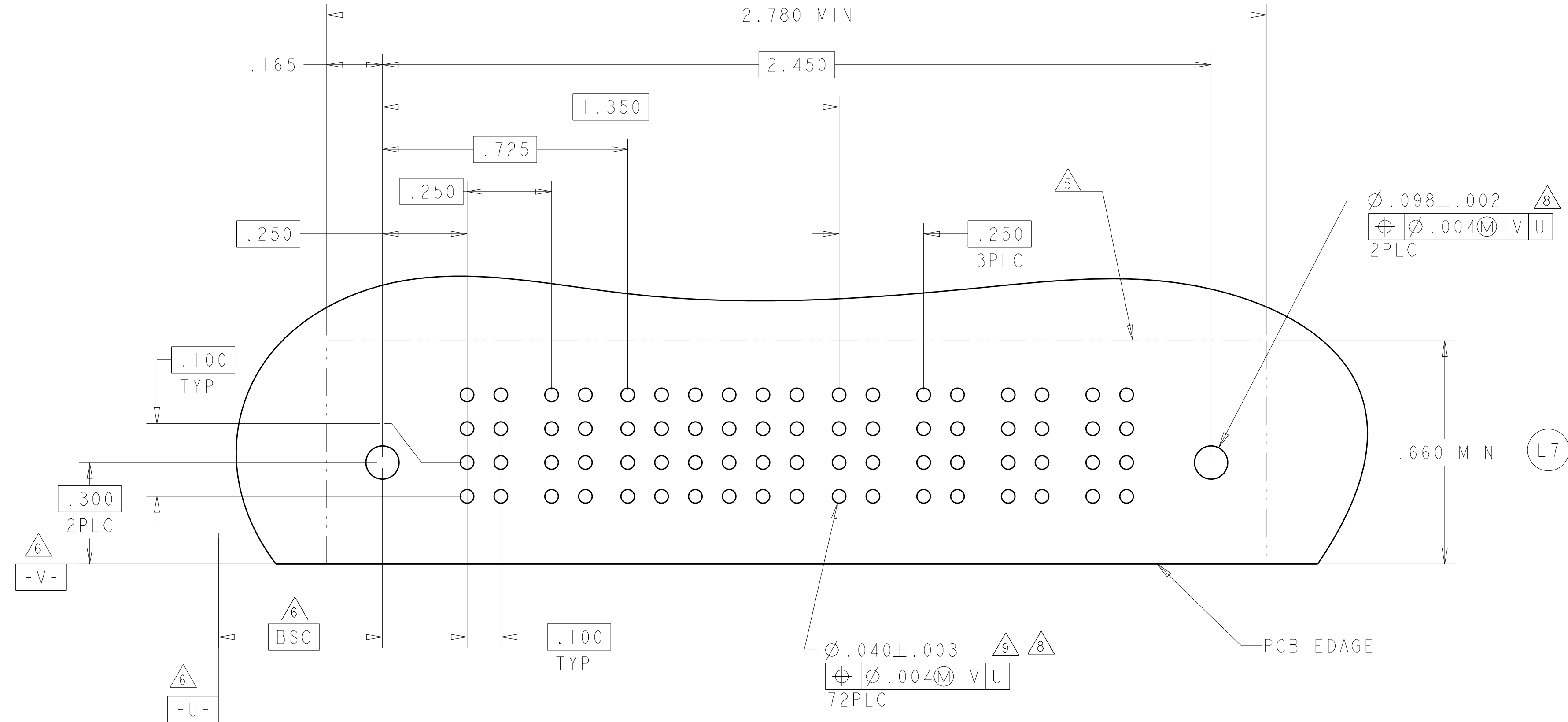

THIS DRAWING IS A CONTROLLED DOCUMENT.		DWN: R. GRZYBOWSKI 14FEB2005	 TE Connectivity
DIMENSIONS: INCHES		CHK: M. PERCHERKE 14FEB2005	
TOLERANCES UNLESS OTHERWISE SPECIFIED: 0 PLC ±. 1 PLC ±.01 2 PLC ±.01 3 PLC ±.005 4 PLC ±.0020 ANGLES ±.2°		APVD: M. PERCHERKE 14FEB2005	NAME: RIGHT ANGLE HEADER ASSEMBLY W/GUIDES MULTI-BEAM XL
		PRODUCT SPEC: 108-1973	SIZE: A1
MATERIAL: -		APPLICATION SPEC: 114-13038	CAGE CODE: C=6450130
FINISH: -		WEIGHT: -	RESTRICTED TO: -
Customer Drawing		SCALE: 4:1	SHEET 25 OF 28 REV: M2

LOC	DIST	REVISIONS			
P	LTH	DESCRIPTION	DATE	DMN	APVD
-	-	SEE SHEET 1	-	-	-

PART NUMBER	ROWS	POWER	SIGNAL						POWER					
			P1	P2	P3	P4	1	2	3	4	5	6	P5	P6
5-6450130-3	D C B A	PM	PM	PM	PM	J	J	J	J	J	J	PM	PM	PM
						K	K	K	K	K	K			
						N	N	N	N	N	N			
						H	S	S	S	S	S			
4HDP + 24S + 3HDP														

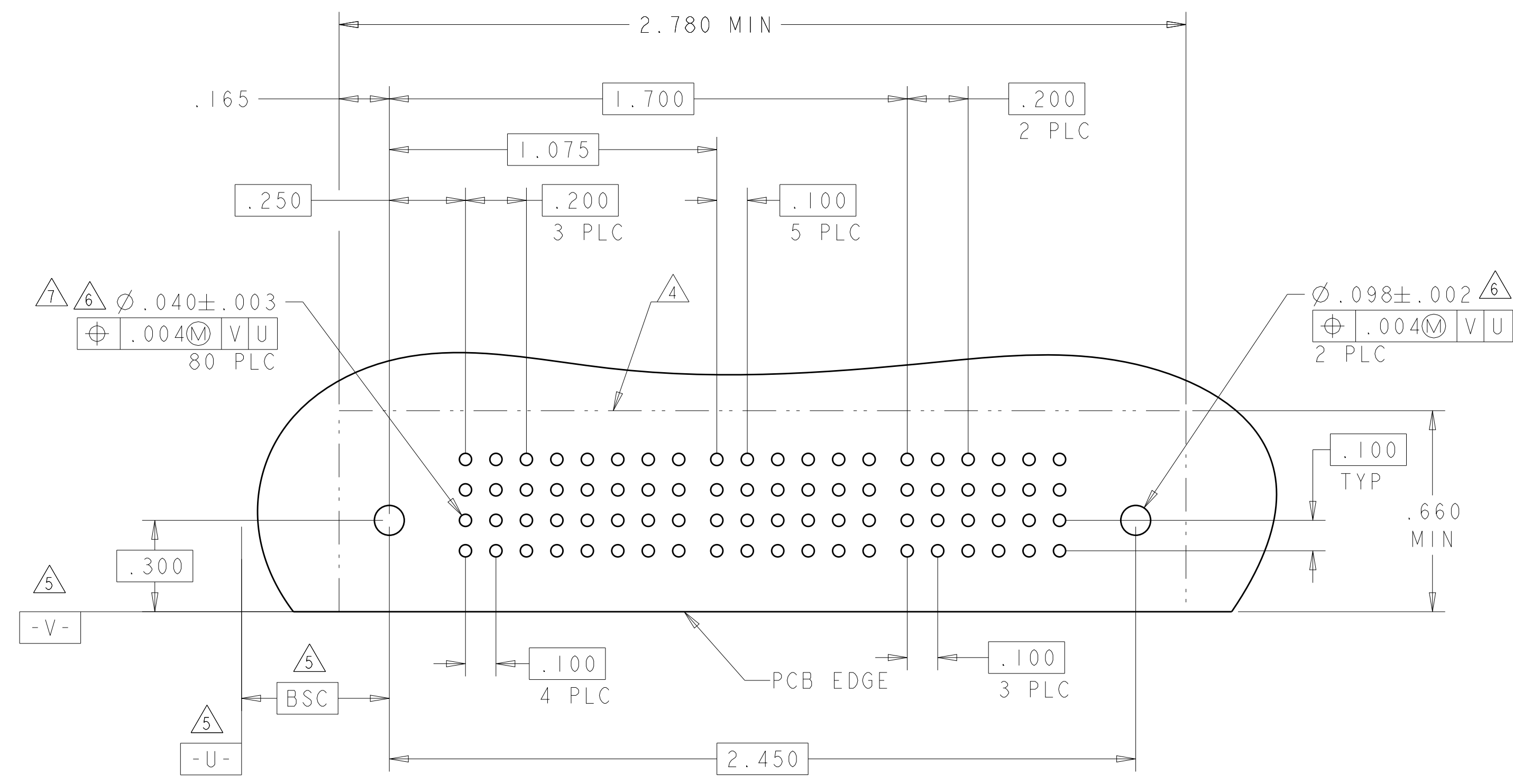

THIS DRAWING IS A CONTROLLED DOCUMENT.		DMN: R. GRZYBOWSKI 14FEB2005	 TE Connectivity
DIMENSIONS: INCHES		CHK: M. PERCHERKE 14FEB2005	
TOLERANCES UNLESS OTHERWISE SPECIFIED:		APVD: M. PERCHERKE 14FEB2005	NAME: RIGHT ANGLE HEADER ASSEMBLY W/GUIDES MULTI-BEAM XL
0 PLC ±. 1 PLC ±.01 2 PLC ±.01 3 PLC ±.005 4 PLC ±.0020 ANGLES ±.2°		PRODUCT SPEC: 108-1973	SIZE: A1
MATERIAL: -		APPLICATION SPEC: 114-13038	CAGE CODE: C=6450130
FINISH: -		WEIGHT: -	RESTRICTED TO: -
Customer Drawing		SCALE: 4:1	SHEET 28 OF 28 REV: M2

单击下面可查看定价，库存，交付和生命周期等信息

[>>TE Connectivity\(泰科\)](#)