

- MATERIAL:
HOUSING: GLASS FILLED POLYESTER; COLOR: BLACK.
CONTACT: PHOS BRONZE
- FINISH:
0.00038[.000015] MIN GOLD PLATE IN CONTACT AREA,
0.00254[.000100] MIN TIN-LEAD ON SOLDER POSTS, ALL
OVER 0.00127[.000050] MIN NICKEL
- AMP LOGO, TE PART NUMBER, DATE CODE AND CSA LOGO INK
STAMPED WHITE (HOT STAMPED OR LAZER PRINTED) IN THE APPROXIMATE
AREA SHOWN, EITHER SIDE PERMISSABLE, WHEN HOUSING SIZE PERMITS
- DATUMS AND BASIC DIMENSIONS ESTABLISHED BY CUSTOMER
- 4 OUNCES OF COPPER REQUIRED
- ELECTRICAL PERFORMANCE OF THIS CONNECTOR IS DIRECTLY RELATED
TO THE VRM 9.0 POWER MODULE BOARD DESIGN AND MAY BE AFFECTED BY
CHANGES TO THAT DESIGN
- CONNECTOR PERFORMANCE IS BASED UPON INFORMATION FROM THE VRM 9.0
AND 9.1 MODULE BOARD DESIGN STANDARD
- CONNECTORS SHOWN ARE USED IN APPLICATIONS WITH VRM MODULES WEIGHING
UP TO 6 OUNCES. ALTERNATIVE CONNECTOR AND LATCHING METHOD IS AVAILABLE
FOR VRM MODULES WEIGHING 3 OUNCES AND LESS. CONSULT TYCO ELECTRONICS
ENGINEERING FOR ADDITIONAL INFORMATION
- KEEP OUT ZONE APPLIES TO BOTH SIDES OF PC BOARD (FRONT AND BACK)

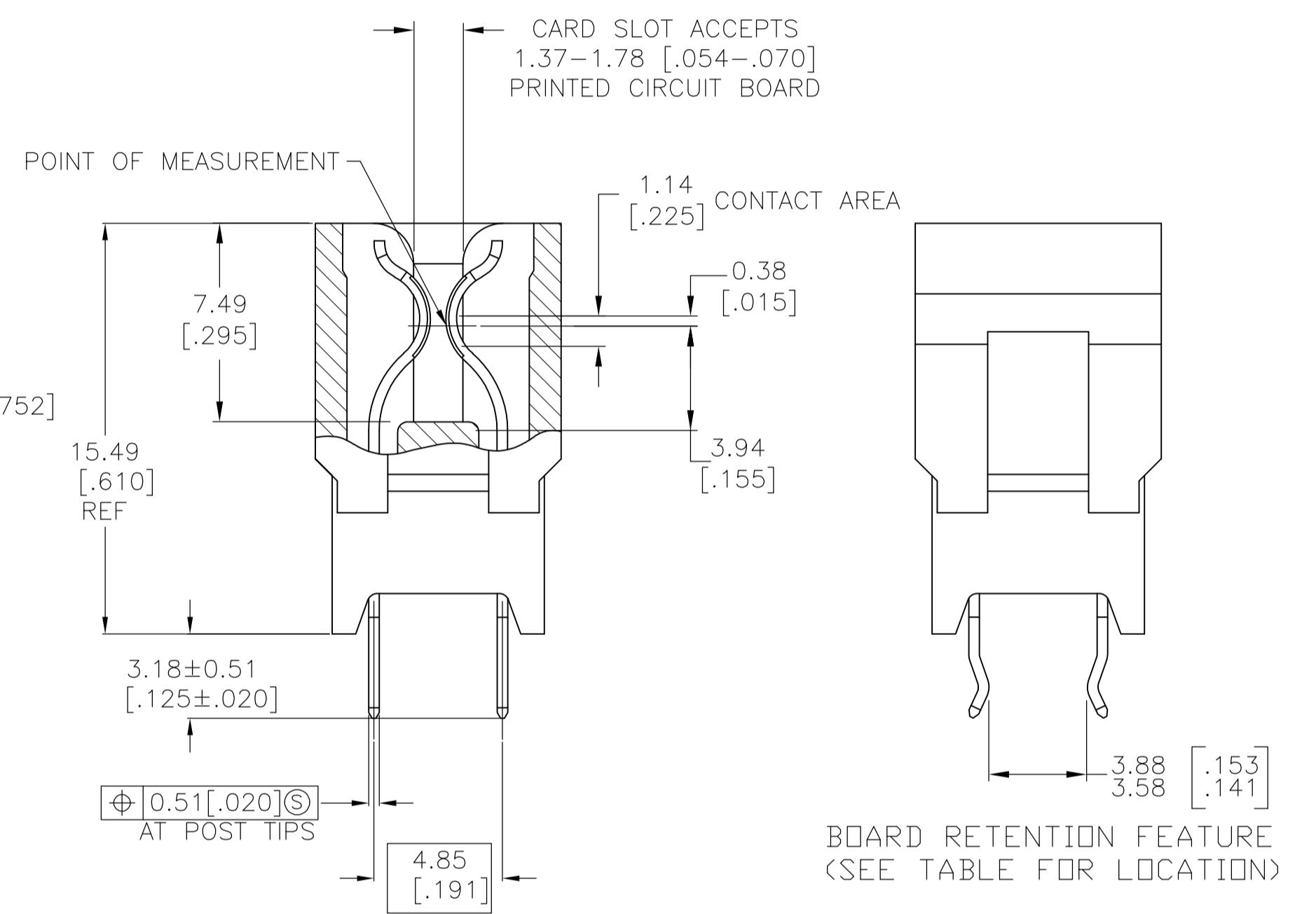
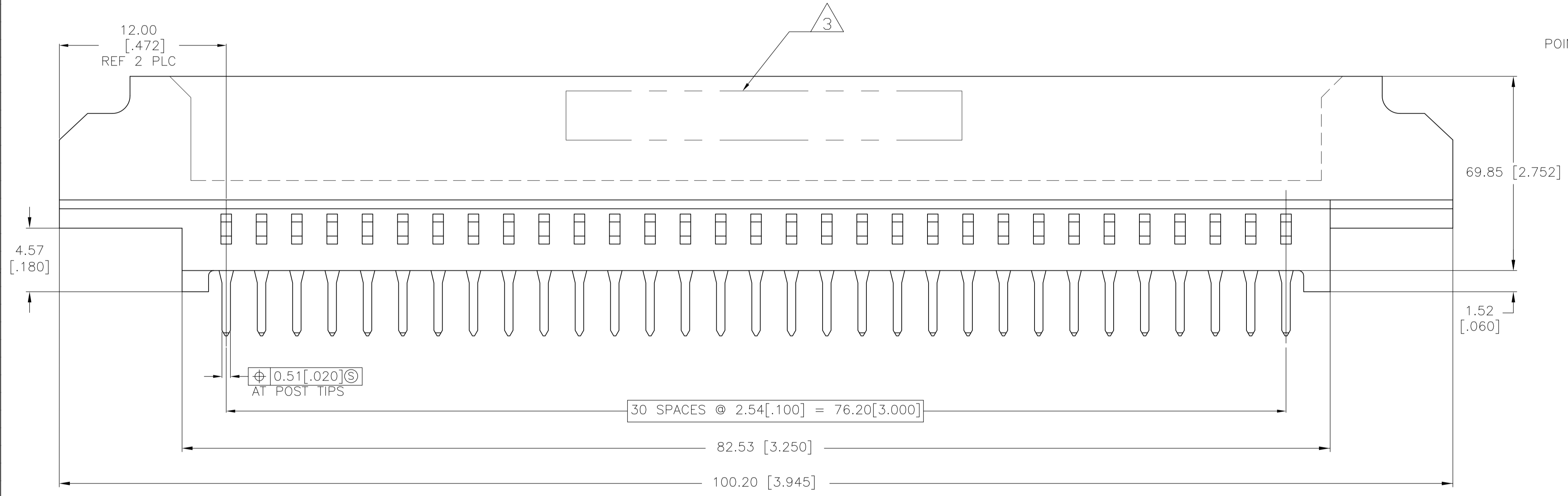
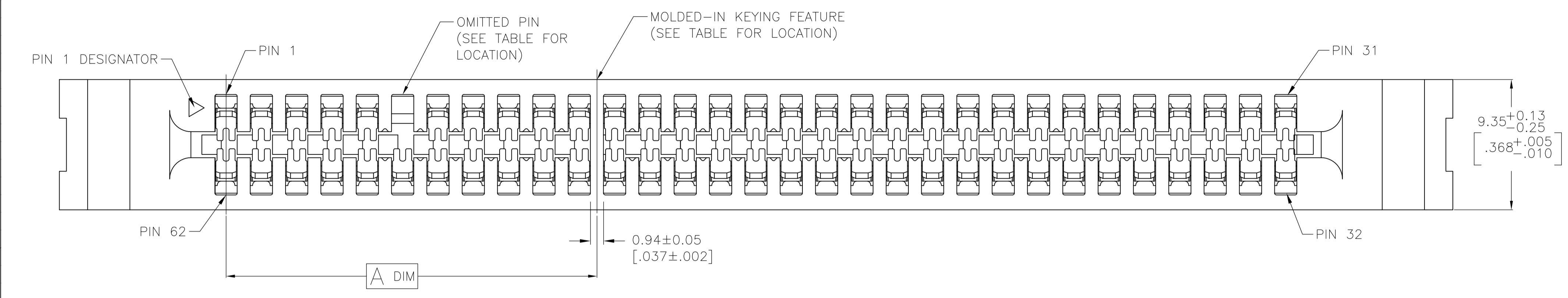

OBsolete	1364125-6
OBsolete	1364125-5
OBsolete	1364125-2

PART NUMBER

2,3,29,30,33,34,60,61	+12V	55	7 & 8	62.06 [2.443]	18.87 [.743]	16.51 [.650]	31	1364125-4
2,3,29,30,33,34,60,61	9.0, +12V	6	11 & 12	51.90 [2.043]	29.03 [1.143]	26.67 [1.050]	31	1364125-1
RETENTION FEATURE LOCATION	VRM DESIGNATION	OMITTED PIN	MOLDED-IN KEYING FEATURE LOCATED BETWEEN PINS	E	D	A	NO OF DUAL POSITIONS	PART NUMBER

THIS DRAWING IS A CONTROLLED DOCUMENT.

DIMENSIONS: MM [INCHES]	TOLERANCES UNLESS OTHERWISE SPECIFIED:	DIN MB/L.A.MAYER 08MAR2008 15OCT99	Tyco Electronics Tyco Electronics Corporation Harrisburg, PA, 17105-3608
0 PLC ± -	1 PLC ± -	AW.FRANTUM	NAME
2 PLC ± 0.25 [01]	3 PLC ± -	S.FLICKINGER	CONNECTOR ASSEMBLY, STANDARD EDGE II, 31 DUAL POSITION
4 PLC ± -	ANGLES ± ±	108-9039-1	2.54 [.100] CENTERLINE
MATERIAL SEE NOTE 1	FINISH SEE NOTE 2	114-13018	SIZE CASE CODE DRAWING NO
		WEIGHT	A1 00779 1364125
		CUSTOMER DRAWING	SCALE 5:1 SHEET 1 OF 3 REV L

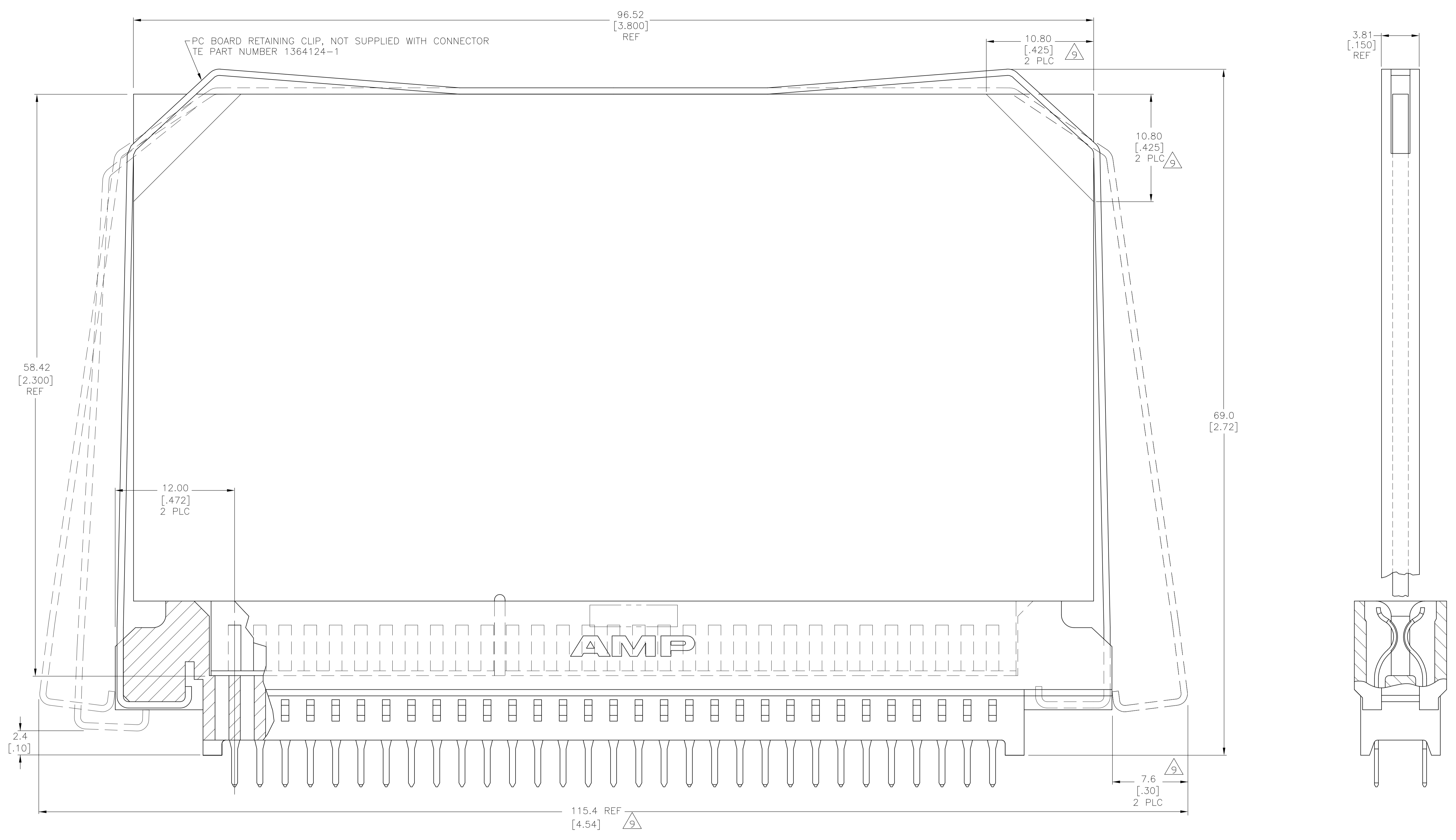

THIS DRAWING IS A CONTROLLED DOCUMENT.		DIN MB/LA.MAYER 08MAR2008	Tyco Electronics Corporation Harrisburg, PA, 17105-3608	
DIMENSIONS: MM [INCHES]		CHK A.W.FRANTUM 15OCT99	APVD S.FLICKINGER 08MAR2008	
TOLERANCES UNLESS OTHERWISE SPECIFIED:		NAME		
0 PLC ± -	1 PLC ± -	CONNECTOR ASSEMBLY, STANDARD EDGE II, 31 DUAL POSITION		
2 PLC ± 0.25 [.01]	3 PLC ± -	2.54 [.100] CENTERLINE		
4 PLC ± -	ANGLES ± ± °	PRODUCT SPEC	SIZE	CAGE CODE
MATERIAL SEE NOTE 1		108-9039-1	A1	00779
FINISH SEE NOTE 2		APPLICATION SPEC	DRAWING NO	REV
		114-13018	1364125	
		WEIGHT	CUSTOMER DRAWING	SCALE 5:1
				SHEET 2 OF 3

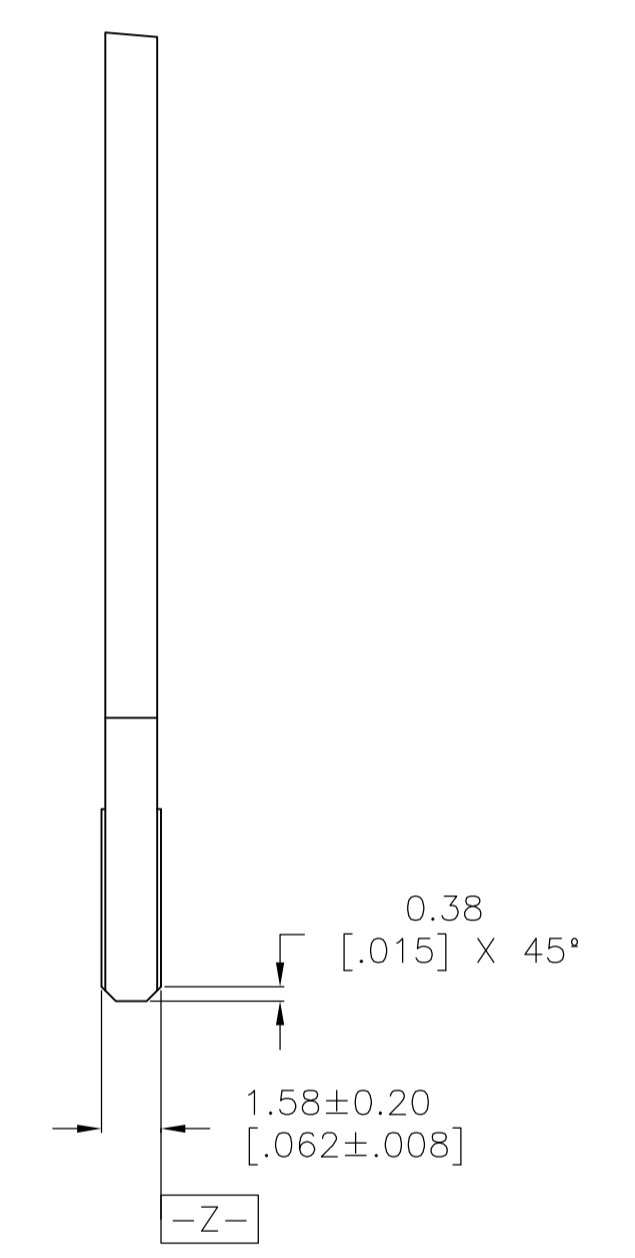
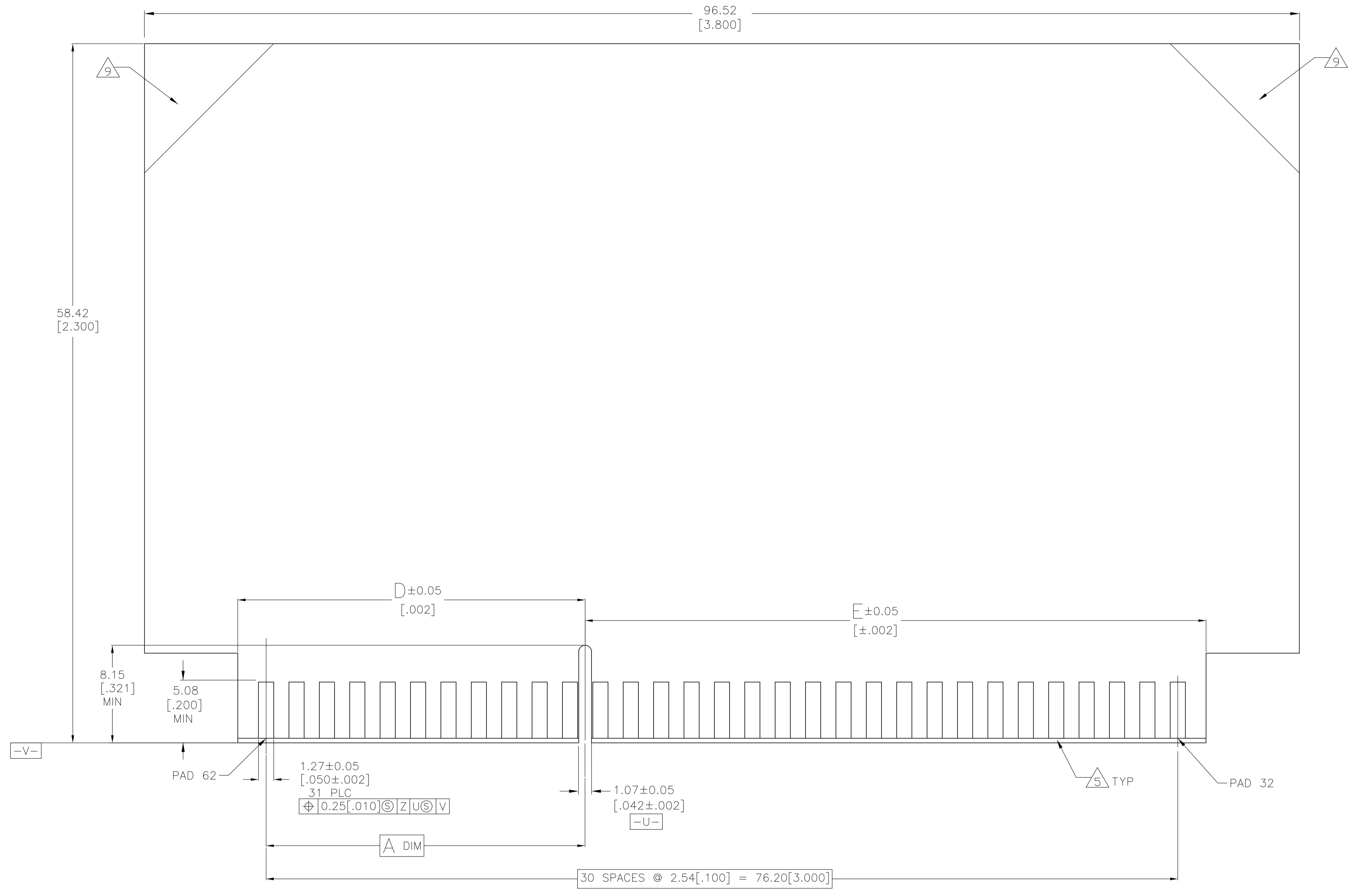

RECOMMENDED MATING BOARD EDGE CONFIGURATION

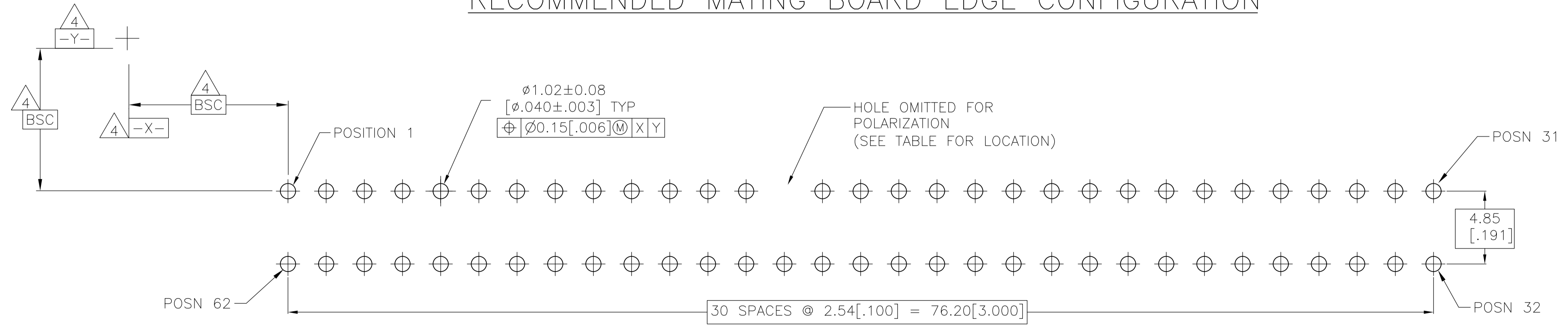

RECOMMENDED PC BOARD HOLE LAYOUT

THIS DRAWING IS A CONTROLLED DOCUMENT.		DIN MB/LA.MAYER 08MAR2008	Tyco Electronics Corporation Harrisburg, PA, 17105-3608	
DIMENSIONS: MM [INCHES]		CHK A.W.FRANTUM 15OCT99	NAME S.FLICKINGER 08MAR2008	
TOLERANCES UNLESS OTHERWISE SPECIFIED:		PRODUCT SPEC		
0. PLC ± -		108-9039-1		
1. PLC ± -		APPLICATION SPEC		
2. PLC ± 0.25 [.01]		114-13018		
3. PLC ± -		SIZE CAGE CODE DRAWING NO		
4. PLC ± -		A1 00779 C=1364125		
ANGLES ± °		RESTRICTED TO		
MATERIAL SEE NOTE 1	FINISH SEE NOTE 2	WEIGHT	CUSTOMER DRAWING	SCALE 5:1 SHEET 3 OF 3 REV

单击下面可查看定价，库存，交付和生命周期等信息

[>>TE Connectivity\(泰科\)](#)